

HCMD-10-S-03.00-01-T

.100" IDC CABLE STRIPS

HCMD, HCMS, HCSD, HCSS, CB

Mates with:

TSW, MTSW, TST, EW, BST, LCW, ZST, MTLW, TSM

Specifications:
HCSD, HCSS

Insulator Material: Black Liquid Crystal Polymer
Flammability Rating: UL 94V-O
Insulation Resistance: 5000 MΩ
Temperature Range: -20°C to +105°C (Rainbow Cable)
-40°C to +105°C (Gray Cable)
Withstanding Voltage: 1000 VRMS @ 60 Hz

Contact:

Phosphor Bronze
Plating: 10μ" (0,25μm) on contact area, 150μ" (3,81μm) Sn on balance over 50μ" (1,27μm) Ni.

Current Rating:

1A

Contact Resistance:

10 mΩ max

Lead Size Range:

.024" (0,61mm) SQ to .026" (0,66mm) SQ

Lead Insertion Depth:

.185" (4,70mm) to .250" (6,35mm)

Insertion Force:

6 oz avg (1,67N) average with .025" (0,64mm) SQ probe

Withdrawal Force:

3 oz avg (0,83N) average with .025" (0,64mm) SQ probe

Wire: 28 AWG 7/36 stranded Tinned Copper

RoHS Compliant:

Yes

Specifications:
HCMD, HCMS

Insulator Material: Black Liquid Crystal Polymer
Flammability Rating: UL 94V-O
Insulation Resistance: 5000 MΩ
Temperature Range: -55°C to +80°C

Withstanding Voltage:

1000 VRMS @ 60 Hz

Terminal:

Phosphor Bronze
Plating: Sn over 50μ" (1,27μm) Ni

Current Rating:

1A

Wire:

28 AWG 7/36 stranded Tinned Copper

RoHS Compliant:

Yes

Note:

IDC assemblies are non-standard, non-returnable.

TYPE STRIP	ROW OPTION	NO. PINS PER ROW	END ASSEMBLY	ASSEMBLED LENGTH
	S = Single	-05, -08, -10, -12, -13, -15, -17, -20, -25, -36		-“XX.XX” = Assembled Length Assembled Length in INCHES (±1/8") 2 inches minimum
	D = Double (Color coded cable N/A for 31 thru 36 pins/row. See -G option.)			

HCM = Male Strip

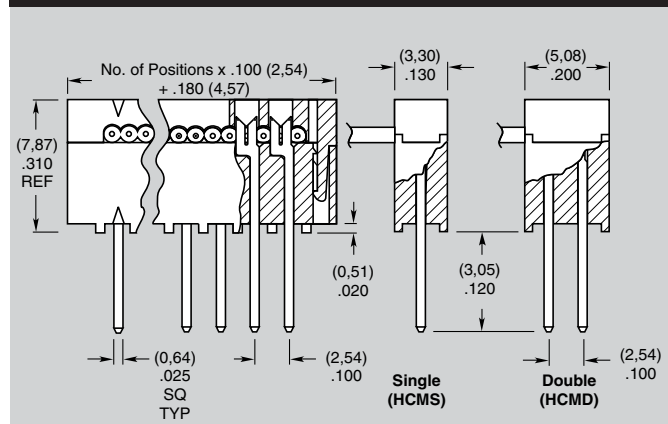

Also Available (5,84mm) .230" tail length specify Lead Style -02 instead of -01

HCS = Socket Strip

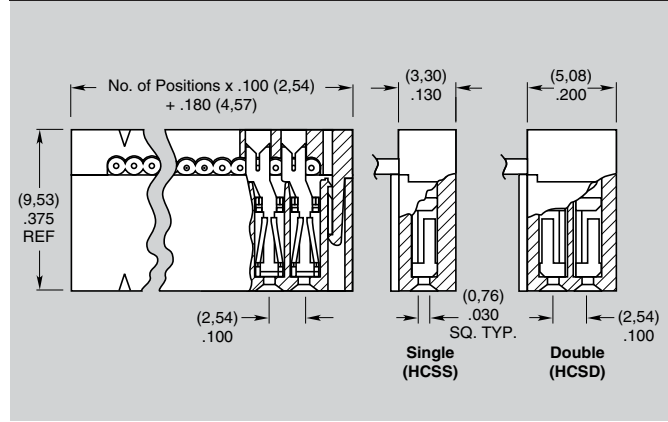

-S = Single End

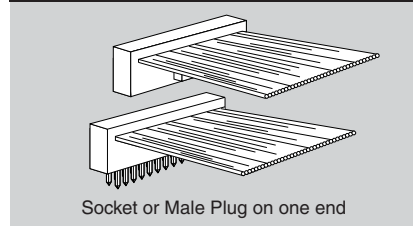

-D = Double End

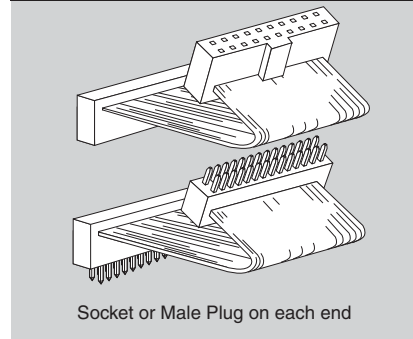

-T = Transfer End

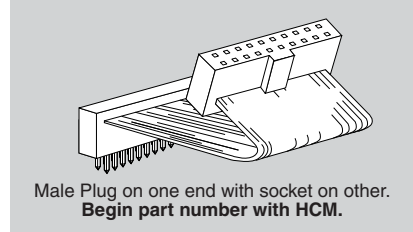

Due to technical progress, all designs, specifications and components are subject to change without notice.

WWW.SAMTEC.COM

SAMTEC USA • Tel: 1-800-SAMTEC-9 or 812-944-6733 • Fax: 812-948-5047
 SAMTEC GERMANY • Tel: +49 (0) 89 / 89460-0 • Fax: +49 (0) 89 / 89460-299
 SAMTEC ASIA PACIFIC • Tel: 65 6745-5955 • Fax: 65 6841-1502
 SAMTEC SINGAPORE • Tel: 652-2800-8821 • Fax: 652-2800-4821
 SAMTEC JAPAN • Tel: 045-475-1385 • Fax: 045-475-1340
 SAMTEC KOREA • Tel: 82-31-717-5685 • Fax: 82-31-717-5681
 SAMTEC SILICON VALLEY • Tel: 408-395-5900 • Fax: 408-395-1520
 SAMTEC FRANCE • Tel: 01 60 95 06 60 • Fax: 01 60 95 06 61
 SAMTEC CHINA • Tel: 86-21-61103766 • Fax: 86-21-61103766
 SAMTEC SOUTH AFRICA • Tel: 27 11 452 8112 • Fax: 27 86 6714432
 SAMTEC UK • Tel: 01236 739292 • Fax: 01236 727113
 SAMTEC ITALY • Tel: 39 039 6890337 • Fax: 39 039 6890315
 SAMTEC INDIA • Tel: +91-80-3272 1612 • Fax: +91-80-4152 8187
 SAMTEC TAIWAN • Tel: 886-2-2735-6109 • Fax: 886-2-2735-5036
 SAMTEC ANZ • Tel: 613 9512 7747 • Fax: 613 9512 7745

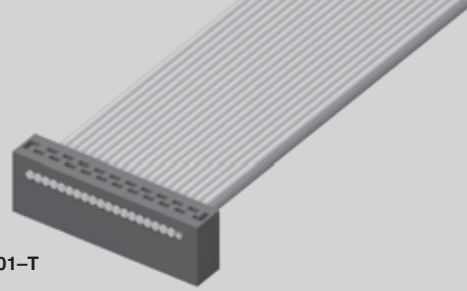

HCSD-10-S-03.00-01-T

.100" IDC CABLE STRIPS

HCMD, HCMS
HCSD, HCSS, CB

01 PLATING OPTION

-S = 10µ" (0,25µm)
Gold on contact area or tail,
Tin on balance
(Standard on HCSS & HCSD.
Leave blank)

-T = Tin
(Standard on HCMS & HCMD.
Leave blank)

NOTCH POLARIZATION

-N = Notch Polarization

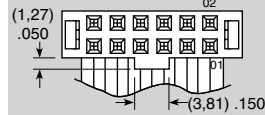

Required for HCSS and HCSD.
(Not available on HCMS or
HCMD, unless Transfer, then
only the socket is polarized.)

OTHER OPTIONS

BULK IDC FLAT CABLE



CB-36-28-7/36-100-C = 36 Conductor/Color Coded
CB-36-28-7/36-100-G = 36 Conductor/Gray



CB-72-28-7/36-050-C = 72 Conductor/Color Coded

-P "XX"

= Position Polarization

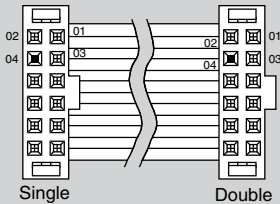

Specify "XX" as position. For Double the same position will be polarized on both ends. (Not available on HCM, unless Transfer, then only the socket is polarized)

-G

= Gray Cable

Standard cable is color coded. Specify -G for Gray cable with one red edge.

-ST "X"

= Stripped & Tinned

Specify Suffix from table. All dimensions are ± 1/16" (1,59mm). Not available in 28 positions and higher.

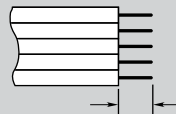

-ST8	1/8" (3,18)
-ST4	1/4" (6,35)
-ST2	1/2" (12,70)
-ST3	3/8" (9,53)

-B "XX"

= Breakout

Specify "XX" as number of conducts to be broken out.

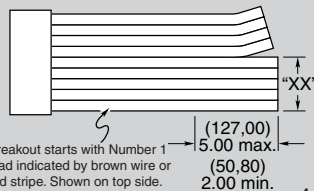

Breakout starts with Number 1 lead indicated by brown wire or red stripe. Shown on top side.

-RW

= Reversed Wiring

#1 wire opposite position #1

-S "XX"

= Daisy Chain Single

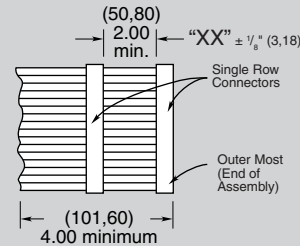

When mating double row connector with two single row connectors, the outer most single will be connected to Conductor #1 and the inside single to Conductor #2.

-D "XX"

= Daisy Chain, Double

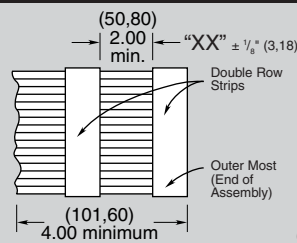

-W "XX"

= Wiring Reversed Daisy Chain, Single

Same as -S "XX" except outer strip connected to conductor #2 and inside strip connected to conductor #1.

-R

= Reversed

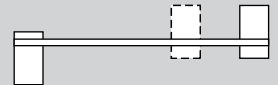

-M

= Middle Reversed

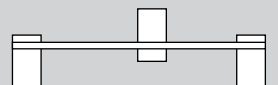

Requires -SXX, -WXX or -DXX

-O

= Outside Reversed

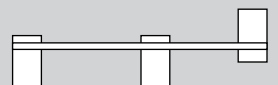

Requires -SXX, -WXX or -DXX

Due to technical progress, all designs, specifications and components are subject to change without notice.

WWW.SAMTEC.COM

SAMTEC USA • Tel: 1-800-SAMTEC-9 or 812-944-6733 • Fax: 812-948-5047 SAMTEC SILICON VALLEY • Tel: 408-395-5900 • Fax: 408-395-1520 SAMTEC UK • Tel: 01236 739292 • Fax: 01236 727113

SAMTEC GERMANY • Tel: +49 (0) 89/89460-0 • Fax: +49 (0) 89/89460-299 SAMTEC FRANCE • Tel: 01 60 95 06 60 • Fax: 01 60 95 06 61 SAMTEC ITALY • Tel: 39 039 6890337 • Fax: 39 039 6890315

SAMTEC NORDIC/BALTIC • Tel: +46-84477280 • Fax: +46-87420413 SAMTEC ISRAEL • Tel: 972-3-7526600 • Fax: 972-3-7526690 SAMTEC INDIA • Tel: +91-80-3272 1612 • Fax: +91-80-4152 8187

SAMTEC ASIA PACIFIC • Tel: 65 6745-5955 • Fax: 65 6841-1502 SAMTEC JAPAN • Tel: 045-475-1385 • Fax: 045-475-1340 SAMTEC CHINA • Tel: 86-21-61103766 • Fax: 86-21-5423 4575 SAMTEC TAIWAN • Tel: 886-2-2735-6109 • Fax: 886-2-2735-5036

SAMTEC HONG KONG • Tel: 852-2600-4850 • Fax: 852-2600-4841 SAMTEC KOREA • Tel: 82-31-717-5685 • Fax: 82-31-717-5681 SAMTEC SOUTH AFRICA • Tel: 27 11 452 8112 • Fax: 27 86 6714432 SAMTEC ANZ • Tel: 613 9512 7747 • Fax: 613 9512 7745