

Table of Contents

Microdot Introduction 4

Microminiature D Connectors 5-35

 Introduction 5

 MCK/MCD/MCDM Series Metal and Plastic Shell Connectors 6

 How To Specify MCK and MCD Connectors 7

 Contact Arrangements 8

 MCK Series Metal Shell Connectors 9

 MCK Series Metal Shell Connectors Panel Mounting — Cutout Dimensions 10

 MCD Series Plastic Shell Connectors 11, 12

 MCD Series Plastic Shell Connectors Panel Mounting — Cutout Dimensions 13

 Mounting and Coupling Hardware 14, 15

 MCK Transition Blocks

 RT1 — Right Angle 16-18

 ST1 — Straight 19-21

 MCK ST2 Series Straight Mount PCB Connectors 22-24

 MCDM Series Metal Shell Connectors 25, 26

 MCDM Series Metal Shell RF COMBOMATE Connectors 27-29

 MCDM Series Metal Shell Connectors Panel Mounting — Cutout Dimensions 30

 MIL-DTL-83513 Cross Reference 31-35

Rectangular Connectors 37-54

 Introduction 37

 TWIST Pin Contact Data 38

 MCE Plastic

 MCE Series Plastic Shell Edgeboard Connectors 39-41

 Technical & Performance Data 39

 Mother Board & Daughter Board Connectors 40

 How To Specify 41

 MCEM Metal Shell

 MCEM Series Metal Shell Edgeboard Connectors 42-45

 Performance Data 42

 128 Layout Connector 43, 44

 How To Specify 44

 184 Layout Connector 45

 MCJ Plastic

 MCJ Series Plastic Shell Center Jackscrew Connectors 46, 47

 10 & 14 Layout Connectors 46

 26, 38 & 46 Layout Connectors 47

 How To Specify 47

 Contact Arrangements 47

 MCJM Metal Shell

 MCJM Series Metal Shell Center Jackscrew Connectors 46, 48, 49

 Technical & Performance Data 48

 Plug & Receptacle Connectors 48, 49

 How To Specify 49

Table of Contents (Continued)

MCS .050 [1.27] Centerline
 MCS Series Strip Connectors 50
 Strip Connectors 50
 How To Specify 50
 High Density Standard Module (HDSM) Connectors 51-54

Circular Connectors. 57-92

Introduction 55, 56

MARC 43
 General Information 57
 Materials and Finishes 57
 Service & Performance Data 57
 Test Data 58
 Contact Arrangements 58
 Part Number & Ordering Information 59
 Polarizing Key Positions 59
 Shell Configurations 60-62
 Cable Clamps, Contacts, Sealing Plugs,
 Protective Covers & Modifications 63

MARC 53
 General Information 64
 Materials and Finishes 64
 Service & Performance Data 65
 Test Data 66
 Contact Arrangements 67
 Part Number & Ordering Information 67
 Polarizing Key Positions 68
 Shell Configurations 69-71
 Test Adapters, Protective Covers, Cable Clamps
 & Modifications 72, 73

MARC 63
 Performance Data 74
 Part Number & Ordering Information 75
 Shell Configurations 75, 76
 Cable Clamps, Protective Covers & Modifications 77

MARC 43, 53, 63
 Contacts & Sealing Plugs 78-80

MARC 43, 53, 63, 73
 Assembly Tools 81

MARC 73
 Service & Performance Data 82, 83
 Part Number & Ordering Information 83
 Shell Configurations 84, 85
 Cable Clamps, Contacts & Sealing Plugs 85, 86

MQR Series – Microminiature Circular Connectors 87, 88

MTC Series – Microminiature Circular Connectors 89, 90

Table of Contents (Continued)

Coaxial Connectors 91-136

Introduction 91

Standard Coaxial Connectors

 Performance Data/Materials 92

 Screw-On Series (S) 93-98

 Slide-On Series (SOS) 99-102

 Quick-Connect Series (QC) 103-105

 Twinax Series 106

 Triax Series 107

 Terminals 107

 Module Blocks 108

 Caps For Screw-On Jacks and Receptacles 109

 Feed Thru Adapters, Screw-On 110

 BNC/TNC Adapters to:

 Screw-On Series (S) 110, 111

 Slide-On Series (SOS) 111

 Quick-Connect (QC) 111

Gold Plated Crimp Style Coaxial Connectors

 Performance Data/Materials 112

 Screw-On Series 113-116

 Assembly Tools 116

LEPRA/CON Ultra Miniature Connectors

 Performance Data/Materials 117

 Screw-On Series — Standard Interface 118, 119

 Screw-On Series — Locking Interface 120, 121

 Slide-On Series 122, 123

 Assembly Tools 123

 BNC / LEPRA/CON Adapters 124, 125

 Snap-Lock Series 126

Cable Assemblies

 Ordering Instructions 127

 Mating Interface Chart 128

Cable Acceptance Dimensions

 Standard Coaxial Connectors 129-133

 Gold Plated Crimp Style Coaxial Connectors 133, 134

 LEPRA/CON Connectors 134

Hermetic Connectors

 Coaxial Screw-On, Slide-On Series 135, 136

MICRODOT Introduction

MICRODOT Connector products have a fifty-year heritage of leadership in precision design and manufacturing of innovative and cost-effective interconnects. These innovative and cost-effective products offer interconnect solutions for a broad range of applications in the Aerospace, Military, Medical, Instrumentation, Communications and Computer markets.

The MICRODOT reputation for hands-on experience and outstanding technical support is now enhanced as part of Tyco Electronics Corporation.

From standard Mil-Spec configurations to custom designs, we have the Micro-D, subminiature and ultra-miniature coaxial, custom hermetic and space-related cylindrical

connectors to meet your need, whether it is build-to-print assemblies, or total turn-key assembly program management. MICRODOT connectors have met the rigorous demands imposed in manned space flight, military and commercial satellites, critical medical applications, and geophysical exploration.

Microminiature D Connectors

Product Facts

- Designed for both military and commercial applications
- Low engaging force is achieved by the manner in which Twist Pin Contacts are designed
- The metal shell and plastic shell are available with solder cup and solid or stranded wire terminations
- Mating force maximum is 10 oz. [2.78N] times the number of contacts
- Durability — No known mechanical or electrical issues detrimental to the function of the connectors after 500 cycles of mating and unmating
- Current Rating — 3 amps max per contact



MICRODOT Connectors MCK and MCD High Density Microminiature "D" Connectors described in this catalog comprise a complete connector system, which is adaptable to a numerous variety of form factors. Low engaging force is achieved by the manner in which the twist pin contacts are designed. By constructing the male contact as a breathing helical spring, electrical contact is achieved at many points around the periphery of the pin bundle rather than at a few discrete points, as in conventional pin designs. Normal twist

pin engagement force is 6 oz. [1.67N] typically and 8 oz. [2.22N] maximum. The low force twist pins exhibit an engaging force of 4 oz. [1.11N] typically and 5 oz. [1.39N] maximum. Low force twist pins are standard in MIL-DTL-83513 configurations of MCK and MCD connectors and may be supplied as an option in all other configurations.

The MCK and MCD Series of connectors featured in this catalog are designed to meet the applicable requirements of MIL-DTL-83513, for intermateability, interchangeability, and

performance. Designed for both military and commercial applications, the MCK's and MCD's are especially well suited for use in miniaturized airborne and space electronics, computers, and test equipment. The metal shell MCK's and plastic shell MCD's are available with solder cup, and solid or stranded wire terminations. MCK transition blocks are standard for printed circuit board mounting. Custom termination configurations for both MCK and MCD can be accommodated. Micro D's are also supplied in wired harness assemblies.

MCK/MCD/MCDM Series Metal and Plastic Shell Connectors

Technical and Performance Data

(Applicable to MCK, MCD and MCDM unless otherwise noted)

Electrical

Contacts — Pin 24 AWG twist pin, Socket 24 AWG precision machined barrel, Wire Range 24 AWG to 30 AWG solid and stranded.

Contact Resistance — (voltage drop) 25 millivolts max. at 3 amps, 77° ± 7.4°F [25° ± 3° C].

Current Rating — 3 amps max. per contact.

Dielectric Withstanding Voltage — Volts RMS 60 Hz at room ambient. At sea level 600V solder pots, 750V wire terminations & transition blocks. At 70,000 ft. [21,336 m] 150V solder pots, 200V wire terminations & transition blocks.

Insulation Resistance — 5,000 megohms min. (@ 500 VDC) at ambient room temperature.

Magnetic Permeability — 2 mu max.

Mechanical

Contact Spacing — .050 [1.27mm] centers.

Contact Engagement & Separation — Standard contact engaging force is 6.0 oz. [1.67N] (8.0 oz. [2.22N] max.). Separation force is 0.5 [1.4N] oz. min.

Mating Force Maximum — Calculated as 10 oz. times the number of contacts.

Environmental

Temperature Range — -67°F to 257°F [-55° C to +125° C] for MCK/MCD, -67°F to 302°F [-55° C to +150° C] for MCDM.

Vibration — No discontinuity in excess of 1 µ sec. when tested in accordance with MIL-STD-1344, Method 2005, test Condition IV.

Solderability — Connectors shall pass the test requirements of MIL-STD-202, Method 208

Shock — No discontinuity in excess of 1 µ sec. when tested in accordance with MIL-STD-1344, Method 2004, test Condition E.

Durability — No mechanical or electrical defects detrimental to the function of the connectors after 500 cycles of mating and unmating.

Humidity — After exposure to humidity as specified by MIL-STD-1344, Method 1002, Type II, IR shall be 1 megohm min. following step 7a of Method 1002 and 1000 megohms min. after 24 hours of conditioning per Method 1002.

Salt Spray — Connectors shall meet the performance requirements of contact resistance, mating and unmating forces, and contact retention after being subjected to the 48-hour 5% solution salt spray test per MIL-STD-1344, Method 1001, Condition B.

Fluid Immersion — Unmated connectors after being fully immersed in one of the following fluids, for the prescribed time, will mate at a force of 10 oz.

[2.78N] times the number of contacts or less: Perchloroethylene, 2 hours; Lubricating oil per MIL-L-23699, 20 hours.

Insert Retention — Inserts will withstand a 50 lb. [34N/cm²] per square inch load in either direction.

Crimp Termination Tensile Strength — (Unassembled contacts with crimped stranded wire terminations) Wires will not pull out of contacts when the following axial loads are applied: 24 AWG, 5 lbs. [22.24N]; 26 AWG, 4 lbs. [17.79N]; 28 AWG, 3 lbs. [13.34N]

Outgassing — When tested in accordance with SP-R-0022, Total Mass Loss (TML) shall be less than 1.0% and Volatile Condensable Material (VCM) shall be less than 0.1% of the original specimen.

Materials and Finishes

Contacts — Copper alloy plated with .000050 [0.00127] gold over copper flash per MIL-G-45204 Type II.

Hardware — see pages 14 and 15.

MCK-Metal Shell —

Insulator — Liquid crystal polymer (LCP) per ASTM D5138, or Polyphenylene sulfide GST-40F per ASTM D5927 or MIL-M-24519

Interfacial Seal — Fluorosilicone Rubber per MIL-R-25988 (socket side only)

Body Shell — Aluminum alloy-high grade plated

Cadmium per QQ-P-416

Nickel, electroless per AMS 2404

Transition Block Shell —

Liquid crystal polymer (LCP) per ASTM D5138, or Polyphenylene sulfide GST-40F per ASTM D5927 or MIL-M-24519

Potting Material — Epoxy, Black

MCD-Plastic Shell —

Insulator/Body — Polyester, glass filled per MIL-M-24519, Liquid crystal polymer (LCP) per ASTM D5138, or Polyphenylene sulfide GST-40F per ASTM D5927 or MIL-M-24519

Wire Terminations —

Solid copper per QQ-W-343 gold plated per MIL-G-45204

Stranded TEFLON insulated per MIL-W-16878

Stranded TEFLON insulated per MIL-W-22759/11, /13

Solid copper per QQ-W-343, solder dipped (Transition block)

MCDM-Metal Shell —

Insulator — Diallyl Phthalate per MIL-M-14, Type SDG-F

Body Shell — Aluminum alloy—high grade, nickel plated

Twist Pin, Pin and Socket Contacts

The contact spring member normally found in socket contacts has been eliminated by creating a breathing helical spring principle on the pin contact — smaller, more durable contacts can be manufactured economically.



Wire range 24-36 AWG solid & stranded.

MIL-DTL-83513 — Only the descriptive legend in bold italic is applicable to current MIL-DTL-83513 configurations; MIL-DTL-83513/1 through /4 — MCK metal shell; MIL-DTL-83513/6 through /9 — MCD plastic shell.

In addition, MIL-DTL-83513 solid copper wire termination is specified 25 AWG, 0.5; and 1.0 [25.4] lengths only and stranded insulated wire termination is specified 26 AWG, 18.0 [457.2] and 36.0 [914.4] lead lengths only. Hardware for MIL-DTL-83513 configurations is specified separately by the M83513/5-XX designation. M83513/1 through /4 and /6 through /9 specify no hardware (B). Mounting/mating hardware is shown on page 14 with the applicable military nomenclature. The MICRODOT catalog part number for a MIL-DTL-83513 configuration may be constructed to include the desired hardware.

See pages 31-35 for M83513/ cross reference.

Metal Shell

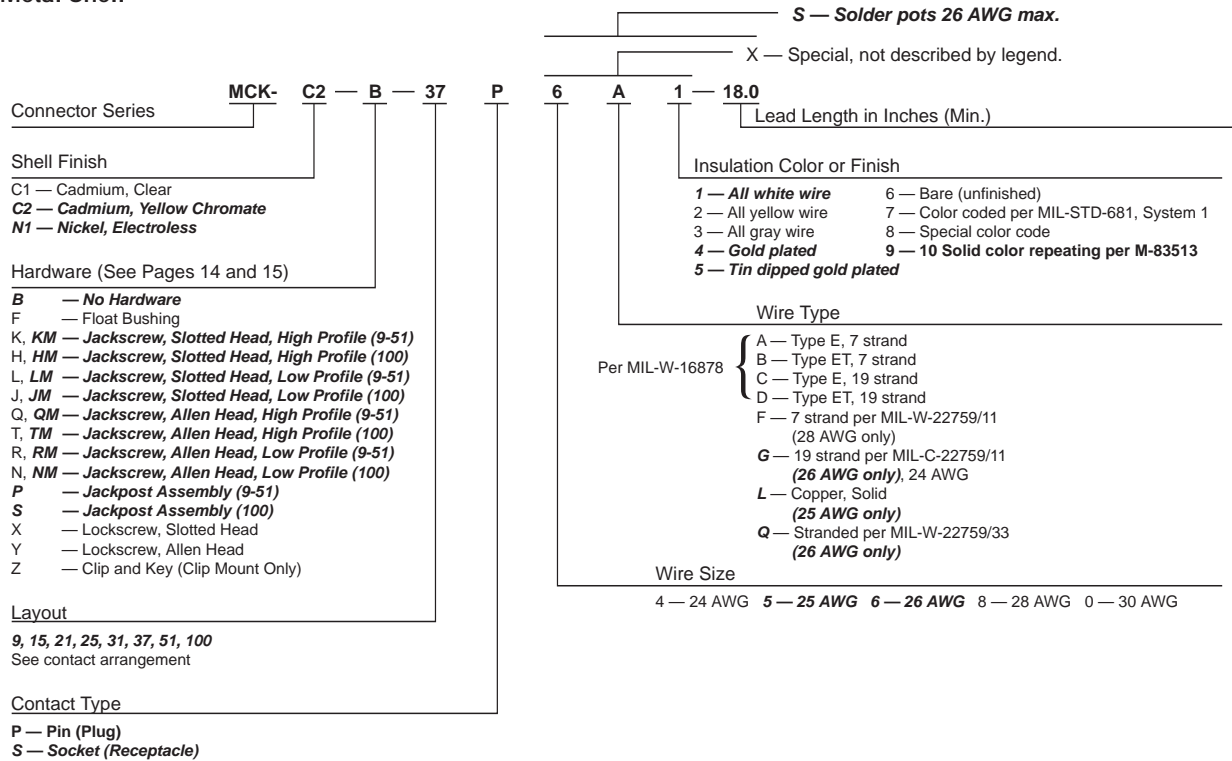

Plastic Shell

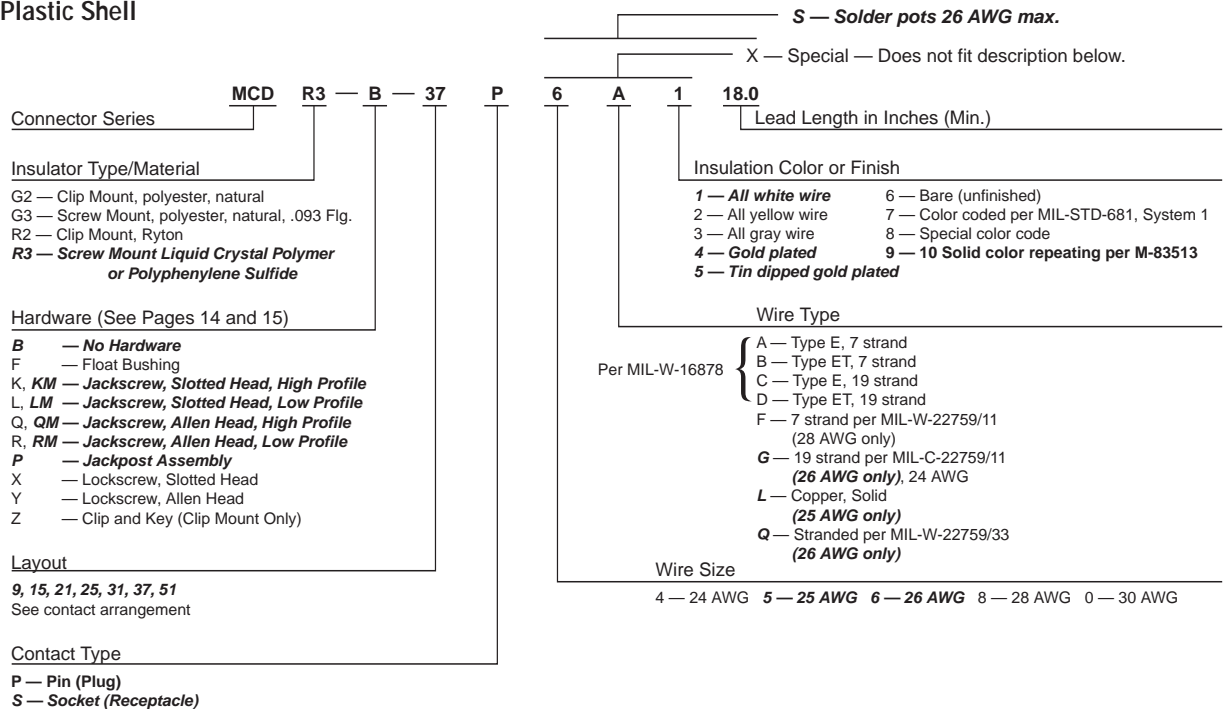

Note: Items in bold italic are qualified to MIL-DTL-83513.

Face View of Pin Insert
(Socket Side is Mirror Image)

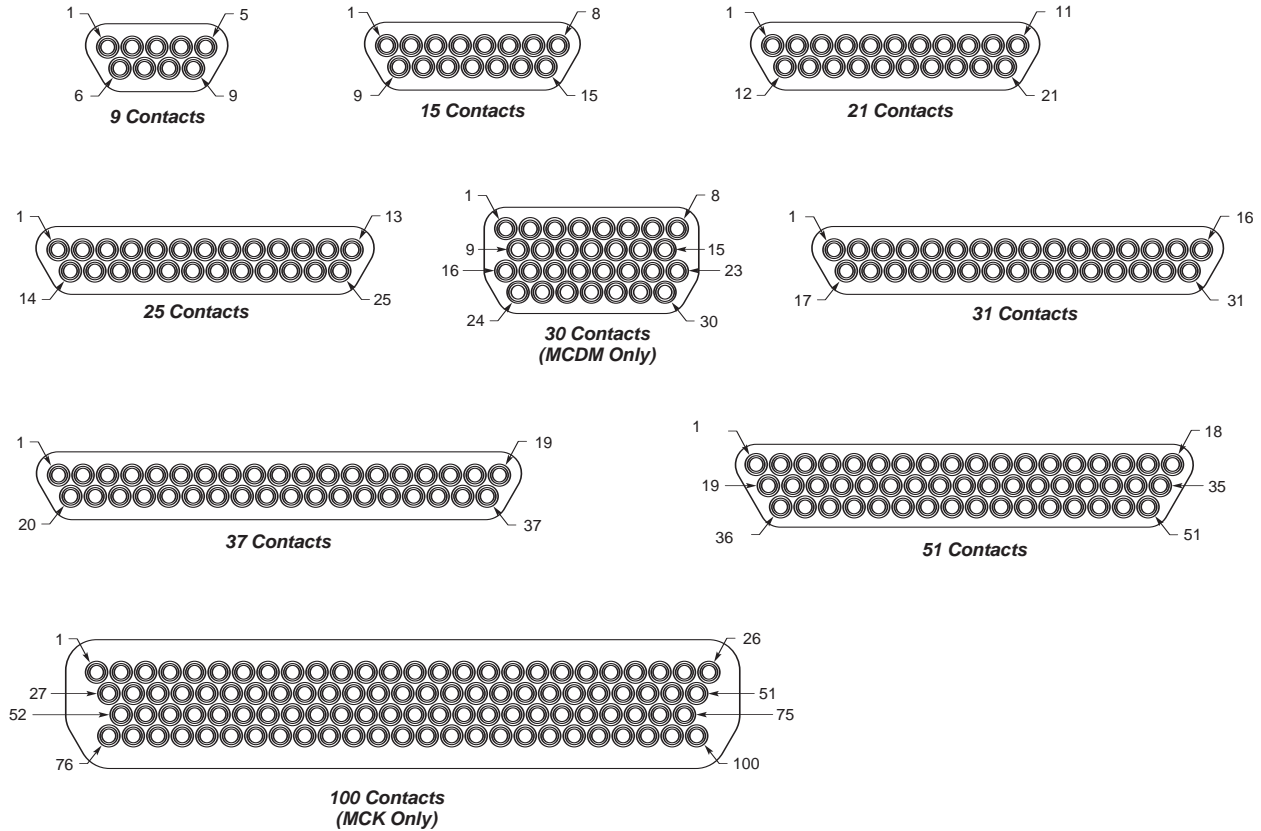

Note: MCK metal shells are not designed to intermate or interchange with MCD plastic shells. If metal/plastic intermating is desired, use MCDM Series Metal Shell on pages 25 and 26 with MCD Series Plastic Shell on page 11.

MCK Series Metal Shell Connectors

Dimensions per MIL-DTL-83513

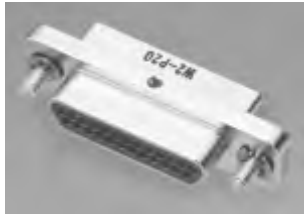

Plug
(Pin side)



Receptacle
(Socket side)

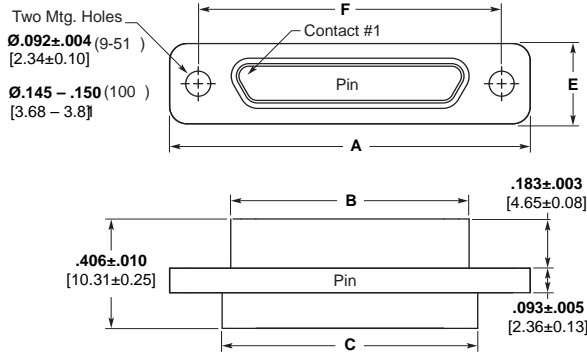

Crimp or Solder

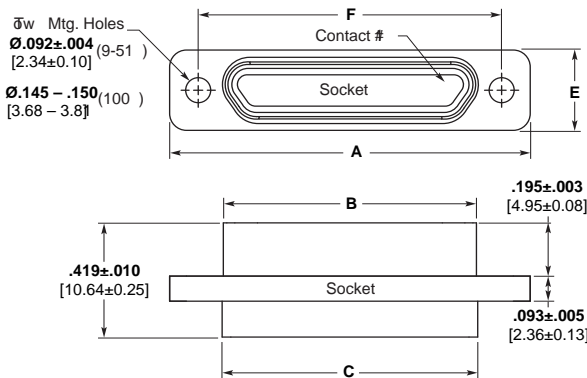
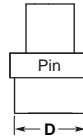

Crimp or Solder

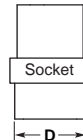

Part Number	A ± .010 [.254]	B Max.	C +.010 [.254] -.018 [.457]	D Max	E ±.010 [.254]	F ± .005 [.127]
MCK**- 9P***	.775 19.68	.3338 8.48	.390 9.91	.270 6.86	.298 7.57	.565 14.35
MCK**- 9S***	.775 19.68	.4018 10.21	.390 9.91	.270 6.86	.298 7.57	.565 14.35
MCK**- 15P***	.925 23.50	.4838 12.29	.540 13.72	.270 6.86	.298 7.57	.715 18.16
MCK**- 15S***	.925 23.50	.5518 14.02	.540 13.72	.270 6.86	.298 7.57	.715 18.16
MCK**- 21P***	1.075 27.30	.6338 16.10	.690 17.53	.270 6.86	.298 7.57	.865 21.97
MCK**- 21S***	1.075 27.30	.7018 18.05	.690 17.53	.270 6.86	.298 7.57	.865 21.97
MCK**- 25P***	1.175 29.84	.7338 18.64	.790 20.07	.270 6.86	.298 7.57	.965 24.51
MCK**- 25S***	1.175 29.84	.8018 20.37	.790 20.07	.270 6.86	.298 7.57	.965 24.51
MCK**- 31P***	1.325 33.66	.8838 22.45	.940 23.88	.270 6.86	.298 7.57	1.115 28.32
MCK**- 31S***	1.325 33.66	.9518 24.18	.940 23.88	.270 6.86	.298 7.57	1.115 28.32
MCK**- 37P***	1.475 37.46	1.0338 26.26	1.090 27.69	.270 6.86	.298 7.57	1.265 32.13
MCK**- 37S***	1.475 37.46	1.1018 27.99	1.090 27.69	.270 6.86	.298 7.57	1.265 32.13
MCK**- 51P***	1.425 36.20	.9838 24.99	1.040 26.42	.310 7.87	.341 8.66	1.215 30.86
MCK**- 51S***	1.425 36.20	1.0518 26.72	1.040 26.42	.310 7.87	.341 8.66	1.215 30.86
MCK**- 100P***	2.160 54.86	1.3838 35.15	1.432 36.37	.360 9.15	.384 9.75	1.800 45.71
MCK**- 100S***	2.160 54.86	1.508 38.30	1.432 36.37	.360 9.15	.384 9.75	1.800 45.71

P = Pin, S = Socket

Panel Mounting Dimensions — MCK

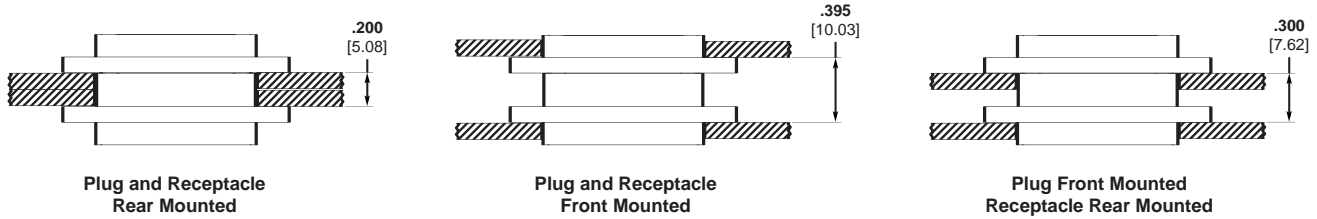

Panel Cutout Dimensions — MCK

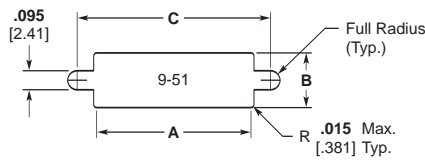

Figure 1 Front Mounting

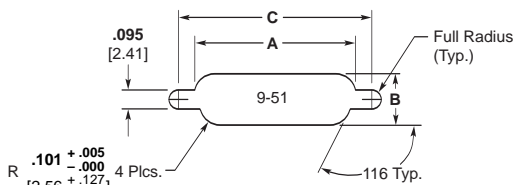
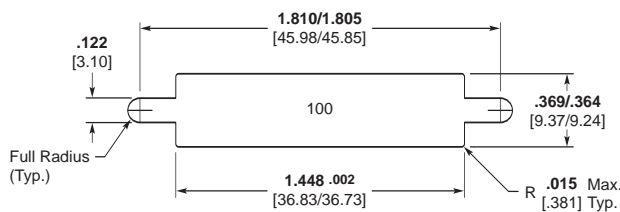
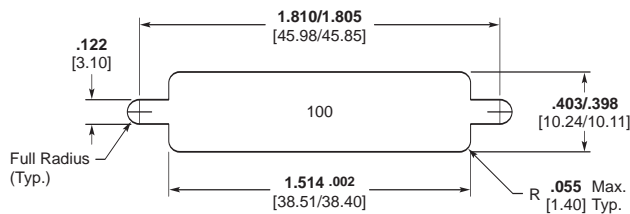

Figure 2 Rear Mounting



Front Mounting



Rear Mounting

Number of Contacts	Fig.	A +.004 [.102] -.000 [.000]	B +.004 [.102] -.000 [.000]	C +.005 [.127] -.000 [.000]
9	1	.404 10.26	.274 6.96	.570 14.48
	2	.406 10.31	.257 6.53	.570 14.48
15	1	.554 14.07	.274 6.96	.720 18.29
	2	.556 14.12	.257 6.53	.720 18.29
21	1	.704 17.88	.274 6.96	.870 22.10
	2	.706 17.93	.257 6.53	.870 22.10
25	1	.804 20.42	.274 6.96	.970 24.64
	2	.806 20.47	.257 6.53	.970 24.64
31	1	.954 24.23	.274 6.96	1.120 28.45
	2	.956 24.28	.257 6.53	1.120 28.45
37	1	1.104 28.04	.274 6.96	1.270 32.26
	2	1.106 28.09	.257 6.53	1.270 32.26
51	1	1.054 26.77	.314 7.98	1.220 30.99
	2	1.056 26.82	.300 7.62	1.220 30.99

MCD Series Plastic Shell Connectors

Screw Mount
Dimensions Per
MIL-DTL-83513



Plug
(Pin side)

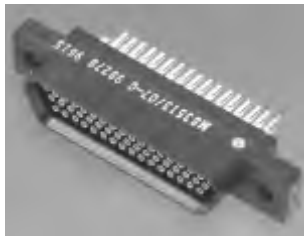

Receptacle
(Socket side)

Liquid Crystal Polymer or
Polyphenylene Sulfide — MCDR3* per
MIL-DTL-83513

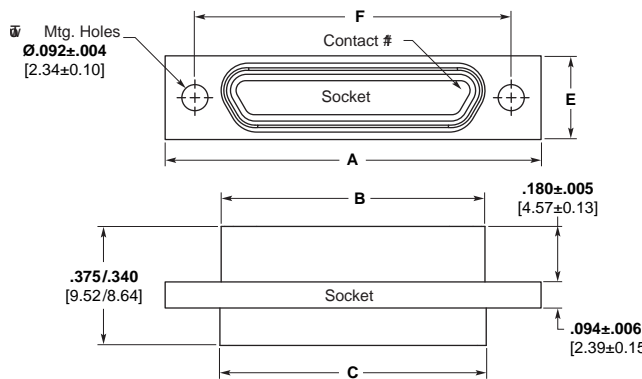
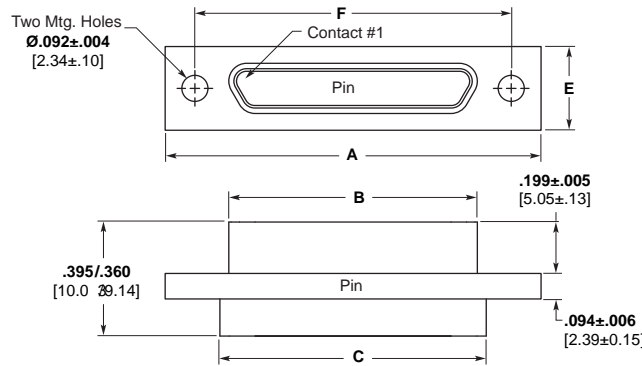

Note: MCD Plastic Screw Mount Series is intermateable with MCDM Metal Series Connectors (Pages 25 and 26).

Part Number	A ± .010 [.254]	B Max.	C +.010 [.254] -.018 [.457]	D Max	E ±.010 [.254]	F ± .005 [.127]	Avg. Weight lbs. ± 5% [grams]
MCD**- 9P***	.778 19.76	.2918 7.412	.398 10.11	.173 4.39	.208 5.28	.565 14.35	.0017 0.77
MCD**- 9S***	.778 19.76	.3798 9.647	.398 10.11	.173 4.39	.208 5.28	.565 14.35	.0016 0.72
MCD**- 15P***	.928 23.57	.4418 11.222	.548 13.92	.173 4.39	.208 5.28	.715 18.16	.0024 1.08
MCD**- 15S***	.928 23.57	.5298 13.457	.548 13.92	.173 4.39	.208 5.28	.715 18.16	.0023 1.04
MCD**- 21P***	1.078 27.38	.5918 15.032	.698 17.73	.173 4.39	.208 5.28	.865 21.97	.0035 1.59
MCD**- 21S***	1.078 27.38	.6798 17.267	.698 17.73	.173 4.39	.208 5.28	.865 21.97	.0034 1.54
MCD**- 25P***	1.178 29.92	.6918 17.572	.798 20.27	.173 4.39	.208 5.28	.965 24.51	.0042 1.90
MCD**- 25S***	1.178 29.92	.7798 19.807	.798 20.27	.173 4.39	.208 5.28	.965 24.51	.0037 1.67
MCD**- 31P***	1.328 33.73	.8418 21.382	.948 24.08	.173 4.39	.208 5.28	1.115 28.32	.0053 2.40
MCD**- 31S***	1.328 33.73	.9298 23.617	.948 24.08	.173 4.39	.208 5.28	1.115 28.32	.0048 2.17
MCD**- 37P***	1.478 37.54	.9918 25.192	1.098 27.89	.173 4.39	.208 5.28	1.265 32.13	.0057 2.58
MCD**- 37S***	1.478 37.54	1.0798 27.427	1.098 27.89	.173 4.39	.208 5.28	1.265 32.13	.0051 2.31
MCD**- 51P***	1.428 36.27	.9418 23.922	1.048 26.62	.220 5.59	.250 6.35	1.215 30.86	.0072 3.26
MCD**- 51S***	1.428 36.27	1.0298 26.157	1.048 26.62	.220 5.59	.250 6.35	1.215 30.86	.0063 2.85

P = Pin, S = Socket

Note: Weight given is with .500 [12.7] uninsulated, solid, 24 AWG gold plated copper pigtails.

*See "How to Specify" for description, on page 7.

MCD Series Plastic Shell Connectors (Continued)

Clip Mount — MCD



Plug
(Pin side)



Receptacle
(Socket side)

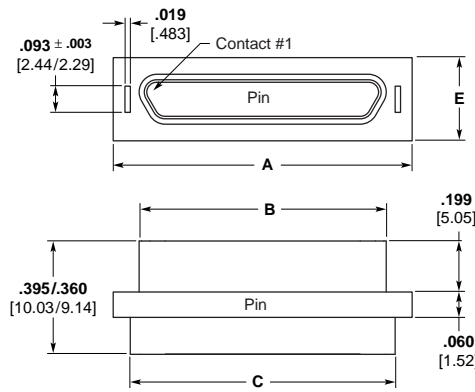

Crimp or Solder

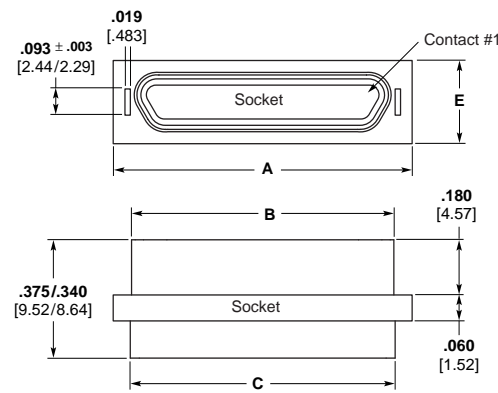
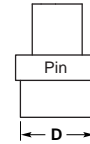

Crimp or Solder

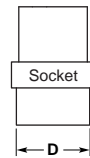

Note: Clip Mount not covered by current issue of MIL-DTL-83513.

Part Number	A ±.005 [.127]	B Max.	C ±.010 [.254]	D ±.010 [.254]	E ±.005 [.127]	Avg. Weight lbs. ± 5% [grams]
MCD**- 9P***	.506 12.85	.2918 74.12	.398 10.11	.165 4.19	.208 5.28	.0017 0.77
MCD**- 9S***	.506 12.85	.3798 96.47	.398 10.11	.165 4.19	.208 5.28	.0016 0.72
MCD**- 15P***	.656 16.66	.4418 112.22	.548 13.92	.165 4.19	.208 5.28	.0024 1.08
MCD**- 15S***	.656 16.66	.5298 134.57	.548 13.92	.165 4.19	.208 5.28	.0023 1.04
MCD**- 21P***	.806 20.47	.5918 150.32	.698 17.73	.165 4.19	.208 5.28	.0035 1.59
MCD**- 21S***	.806 20.47	.6798 172.67	.698 17.73	.165 4.19	.208 5.28	.0034 1.54
MCD**- 25P***	.906 23.01	.6918 175.72	.798 20.27	.165 4.19	.208 5.28	.0042 1.90
MCD**- 25S***	.906 23.01	.7798 198.07	.798 20.27	.165 4.19	.208 5.28	.0037 1.67
MCD**- 31P***	1.056 26.82	.8418 213.82	.948 24.08	.165 4.19	.208 5.28	.0053 2.40
MCD**- 31S***	1.056 26.82	.9298 236.17	.948 24.08	.165 4.19	.208 5.28	.0048 2.17
MCD**- 37P***	1.206 30.63	.9918 251.92	1.098 27.89	.165 4.19	.208 5.28	.0057 2.58
MCD**- 37S***	1.206 30.63	1.0798 274.27	1.098 27.89	.165 4.19	.208 5.28	.0051 2.31
MCD**- 51P***	1.156 29.36	.9418 239.22	1.048 26.62	.208 5.28	.250 6.35	.0072 3.26
MCD**- 51S***	1.156 29.36	1.0298 261.57	1.048 26.62	.208 5.28	.250 6.35	.0063 2.85

P = Pin, S = Socket

Note: Weight given is with .500 [12.7] uninsulated, solid, 24 AWG gold plated copper pigtails.

*See "How to Specify" for description, on page 7.

Panel Mounting Dimensions — MCD

Clip Mount

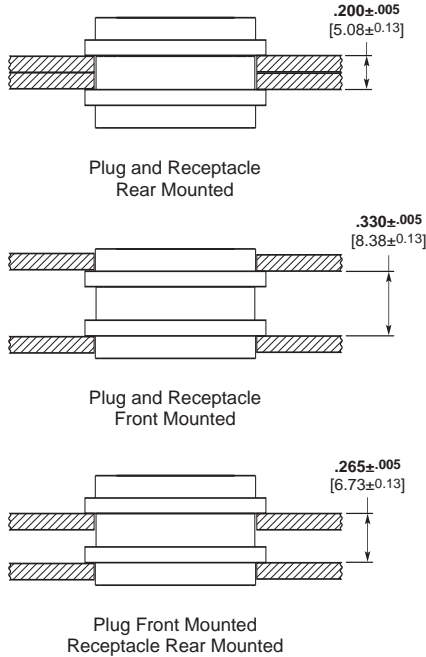

Screw Mount

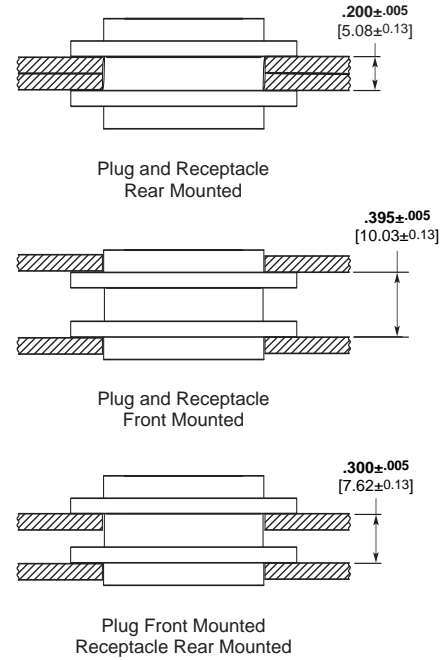

Panel Cutout Dimensions — MCD

Clip Mounting

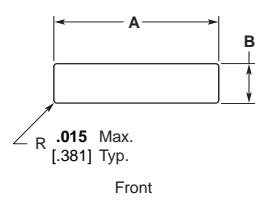

Figure 1

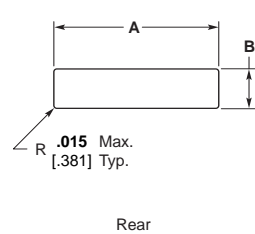

Figure 3

Screw Mounting

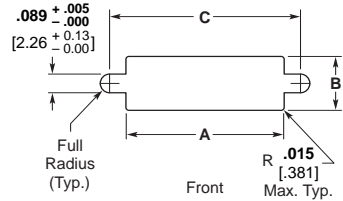

Figure 2

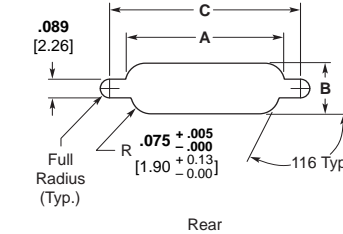

Figure 4

Notes: Front mounting preferred.

Number of Contacts	Fig.	A		B		C	
		+ .004 [.102]	-.000 [.000]	+ .004 [.102]	-.000 [.000]	+ .005 [.127]	-.000 [.000]
9	1	.438 [11.13]		.177 [4.50]		—	
	2	.412 [10.46]		.177 [4.50]		.570 [14.48]	
	3	.438 [11.13]		.222 [5.64]		—	
	4	.384 [9.75]		.222 [5.64]		.570 [14.48]	
15	1	.588 [14.93]		.177 [4.50]		—	
	2	.562 [14.27]		.177 [4.50]		.720 [18.29]	
	3	.588 [14.93]		.222 [5.64]		—	
	4	.534 [13.56]		.222 [5.64]		.720 [18.29]	
21	1	.738 [18.75]		.177 [4.50]		—	
	2	.712 [18.08]		.177 [4.50]		.870 [22.10]	
	3	.738 [18.75]		.222 [5.64]		—	
	4	.684 [17.37]		.222 [5.64]		.870 [22.10]	
25	1	.838 [21.29]		.177 [4.50]		—	
	2	.812 [20.62]		.177 [4.50]		.970 [24.64]	
	3	.838 [21.29]		.222 [5.64]		—	
	4	.784 [19.91]		.222 [5.64]		.970 [24.64]	
31	1	.988 [25.10]		.177 [4.50]		—	
	2	.962 [24.43]		.177 [4.50]		1.120 [28.45]	
	3	.988 [25.10]		.222 [5.64]		—	
	4	.934 [23.72]		.222 [5.64]		1.120 [28.45]	
37	1	1.138 [28.91]		.177 [4.50]		—	
	2	1.112 [28.24]		.177 [4.50]		1.270 [32.26]	
	3	1.138 [28.91]		.222 [5.64]		—	
	4	1.084 [27.53]		.222 [5.64]		1.270 [32.26]	
51	1	1.088 [27.64]		.224 [5.69]		—	
	2	1.062 [26.97]		.224 [5.69]		1.220 [30.99]	
	3	1.088 [27.64]		.264 [6.71]		—	
	4	1.034 [26.26]		.264 [6.71]		1.220 [30.99]	

Mounting and Coupling Hardware

For Screw Mount MCK,
MCD and MCDM

9-51 Contacts
Slot Head

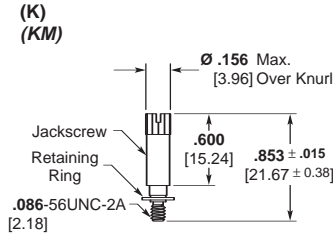

Part Number 5-1532137-8
Jackscrew Assembly
High Profile
(K) 096-0002-0010
M83513/5-06
(KM) S96-0002-0084

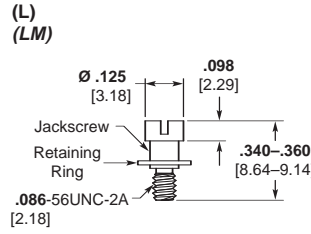

Part Number 5-1532137-7
Jackscrew Assembly
Low Profile
(L) 096-0002-0011
M83513/5-05
(LM) S96-0002-0085

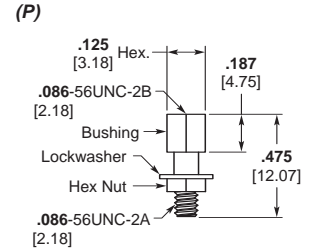

Part Number 5-1532137-9
Jackpost Assembly
(P) S96-0002-0009
M83513/5-07

P mates with K,KM, L,LM, Q,QM and R,RM Jackscrew Assemblies.

9-51 Contacts
1/16" Allen Head

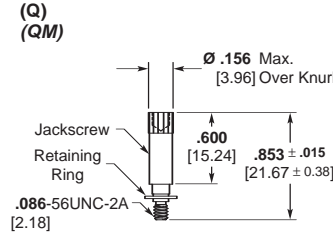

Part Number 5-1532137-6
Jackscrew Assembly
High Profile
(Q) 096-0002-0014
M83513/5-03
(QM) S96-0002-0086

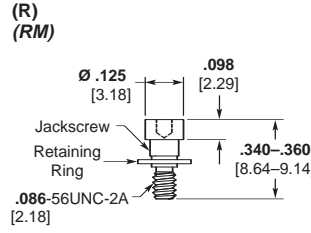

Part Number 5-1532137-5
Jackscrew Assembly
Low Profile
(R) 096-0002-0015
M83513/5-02
(RM) S96-0002-0087

Notes:

- Jackpost Assemblies will accommodate .094 [2.39] max. thickness panel.
- Letter(s) in parentheses is to assist in ordering hardware with the connector (See "How To Specify" page 7).
- Single letters (e.g. K) designate hardware kits (2 pcs. per kit) that meets M83513/05 requirements except the material is 303 stainless steel, passivated.
- Add M suffix (e.g. KM) to designate hardware that meets all M83513/05 requirements. Material is corrosion resistant steel, non-magnetic, 125,000 PSI tensile strength minimum (Applies to jackscrews only).
- Non-MIL hardware ordered separately should be ordered in pairs; i.e. 2 pcs. P/N 096-0002-0009 per connector half.
- Items in bold italic are qualified to MIL-DTL-83513.

100 Contacts
Slot Head

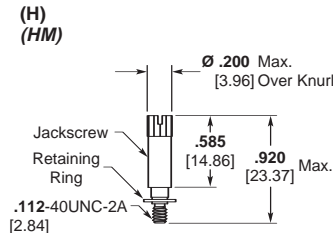

Part Number 6-1532137-3
Jackscrew Assembly
High Profile
(H) 096-0002-0061
M83513/5-16
(HM) S96-0002-0088

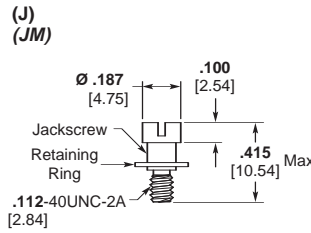

Part Number 6-1532137-2
Jackscrew Assembly
Low Profile
(J) 096-0002-0062
M83513/5-15
(JM) S96-0002-0089

100 Contacts
1/16" Allen Head

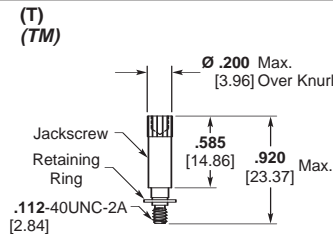

Part Number 6-1532137-1
Jackscrew Assembly
High Profile
(T) 096-0002-0064
M83513/5-13
(TM) S96-0002-0090

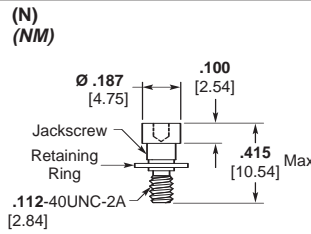

Part Number 6-1532137-0
Jackscrew Assembly
Low Profile
(N) 096-0002-0065
M83513/5-12
(NM) S96-0002-0091

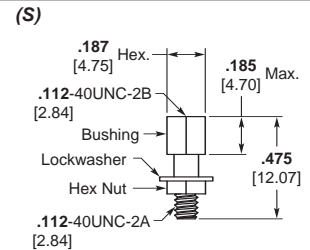

Part Number 6-1532137-4
Jackpost Assembly
(S) S96-0002-0060
M83513/5-17

S mates with H,HM, J,JM, T,TM and N,NM Jackscrew Assemblies.

For Screw Mount MCK,
MCD and MCDM (Continued)

Mounting and Coupling Hardware (Continued)

Slot Head

(X)

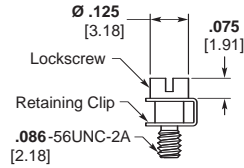

**Part Number 4-1532137-3
Lockscrew Assembly
096-0002-0008**

1/16" Allen Head

(Y)

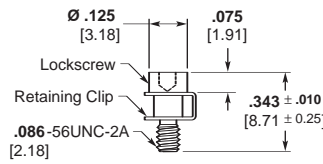

**Part Number 1495164-1
Lockscrew Assembly
096-0002-0013**

For Clip Mount — MCD

(Z)

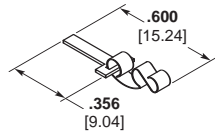

**Part Number 1466018-1
Mounting Key and Clip
P/N 096-0001-0000
(2 Required)**

For Float Mount — MCK,
MCD and MCDM

(F)

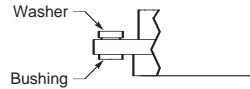

**Float Mount Bushing
(Factory Installed)**

Notes:

1. Jackpost Assemblies will accommodate .094 [2.39] max. thickness panel.
2. Letter(s) in parentheses is to assist in ordering hardware with the connector (See "How To Specify" page 7).
3. Hardware ordered separately should be ordered in pairs; i.e. 2 pcs. P/N 096-0002-0013 per connector half.

MCK Transition Blocks

RT1 — Right-Angle Termination Configuration

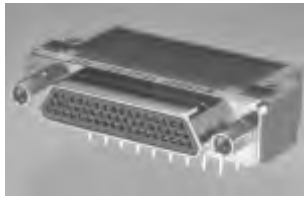

MIL-DTL-83513/10 through /21 configurations. 90° — Lo Profile termination configurations. See pages 31-35 for M83513 cross references.

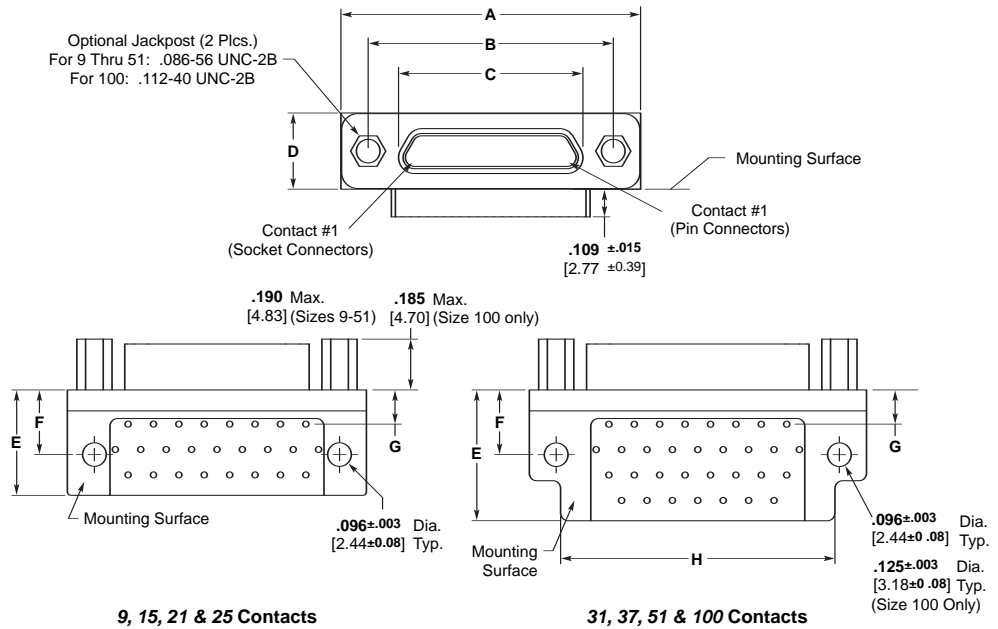

How To Specify

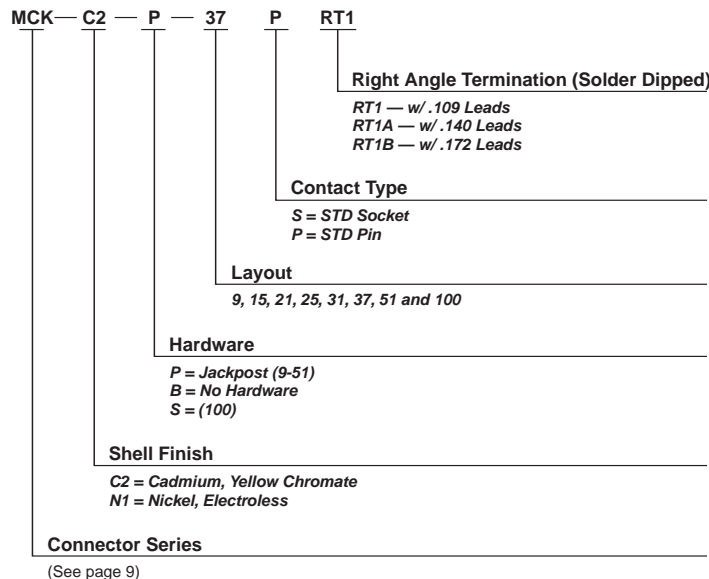

Notes:

1. For terminal identification see page 18.
2. Grid pattern for all configurations is .100 x .100 [2.54 x 2.54].
3. Lead lengths shown are for RT1.
4. Items in bold italic are qualified to MIL-DTL-83513.

RT1 — Right-Angle Termination Configuration

(Continued)

Part Number	A Max.	B ± 005 [.127]	C Max.	D Max.	E Max.	F +.010 [.254]	G +.010 [.254]	H Max.
<i>MCK-**-*- 9PRT1</i>	.787 19.99	.565 14.35	.3338 8.48	.308 7.83	.425 10.80	.250 6.35	.230 5.84	—
<i>MCK-**-*- 9SRT1</i>	.787 19.99	.565 14.35	.4018 10.21	.308 7.83	.425 10.80	.250 6.35	.230 5.84	—
<i>MCK-**-*- 15PRT1</i>	.937 23.80	.715 18.16	.4838 12.29	.308 7.83	.425 10.80	.250 6.35	.130 3.30	—
<i>MCK-**-*- 15SRT1</i>	.937 23.80	.715 18.16	.5518 14.02	.308 7.83	.425 10.80	.250 6.35	.130 3.30	—
<i>MCK-**-*- 21PRT1</i>	1.087 27.61	.865 21.97	.6338 16.10	.308 7.83	.425 10.80	.250 6.35	.130 3.30	—
<i>MCK-**-*- 21SRT1</i>	1.087 27.61	.865 21.97	.7018 17.83	.308 7.83	.425 10.80	.250 6.35	.130 3.30	—
<i>MCK-**-*- 25PRT1</i>	1.187 30.15	.965 24.51	.7338 18.64	.308 7.83	.425 10.80	.250 6.35	.130 3.30	—
<i>MCK-**-*- 25SRT1</i>	1.187 30.15	.965 24.51	.8018 20.37	.308 7.83	.425 10.80	.250 6.35	.130 3.30	—
<i>MCK-**-*- 31PRT1</i>	1.337 33.96	1.115 28.32	.8838 22.45	.308 7.83	.525 13.34	.250 6.35	.130 3.30	1.090 27.69
<i>MCK-**-*- 31SRT1</i>	1.337 33.96	1.115 28.32	.9518 24.18	.308 7.83	.525 13.34	.250 6.35	.130 3.30	1.090 27.69
<i>MCK-**-*- 37PRT1</i>	1.487 37.77	1.265 32.13	1.0338 26.26	.308 7.83	.525 13.34	.250 6.35	.130 3.30	1.190 30.23
<i>MCK-**-*- 37SRT1</i>	1.487 37.77	1.265 32.13	1.1018 27.99	.308 7.83	.525 13.34	.250 6.35	.130 3.30	1.190 30.23
<i>MCK-**-*- 51PRT1</i>	1.435 36.45	1.215 30.86	.9838 24.99	.351 8.92	.660 16.76	.300 7.62	.150 3.81	1.230 31.24
<i>MCK-**-*- 51SRT1</i>	1.435 36.45	1.215 30.86	1.0518 26.72	.351 8.92	.660 16.76	.300 7.62	.150 3.81	1.230 31.24
<i>MCK-**-*- 100PRT1</i>	2.175 55.25	1.800 45.72	1.3838 35.15	.394 10.01	1.010 25.65	.400 10.16	.200 5.08	1.825 46.36
<i>MCK-**-*- 100SRT1</i>	2.175 55.25	1.800 45.72	1.508 38.30	.394 10.01	1.010 25.65	.400 10.16	.200 5.08	1.825 46.36

P = Pin, S = Socket

Note: Items in bold italic are qualified to MIL-DTL-83513.

RT1 — Right-Angle Termination Configuration

(Continued)

View is from mounting surface of connector. Plug configuration shown. For receptacle, use mirror image. (Except 100 contacts)

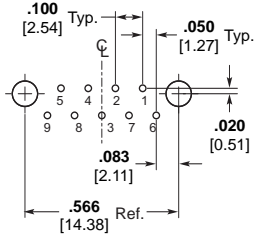

9 Contacts

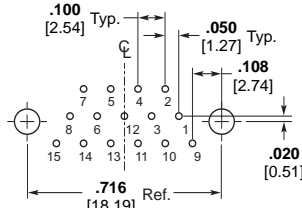

15 Contacts

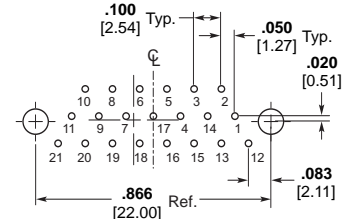

21 Contacts

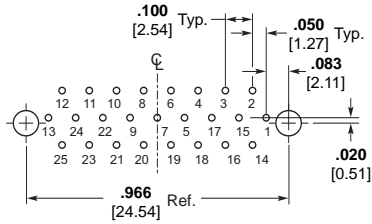

25 Contacts

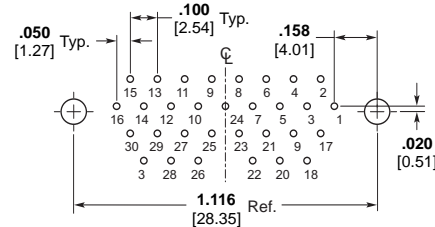

31 Contacts

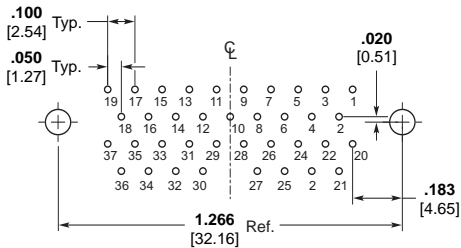

37 Contacts

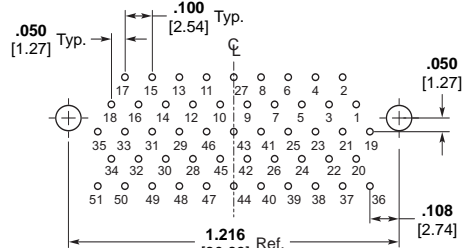

51 Contacts

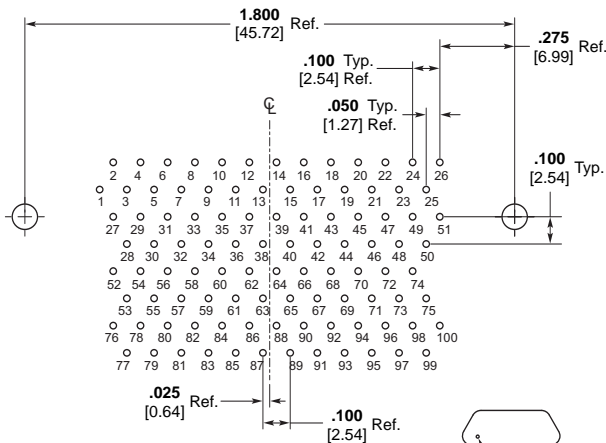

100 Contacts (Socket Connector)

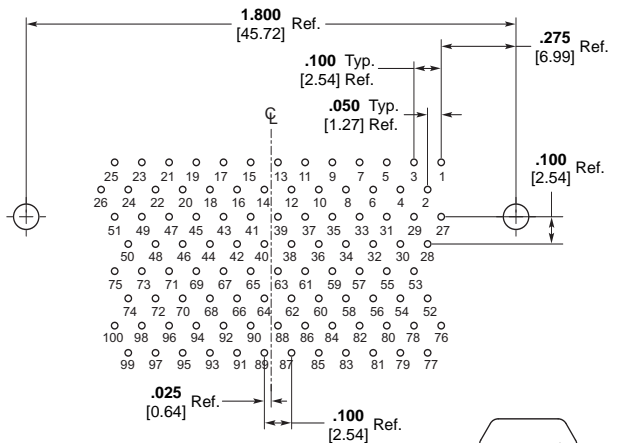
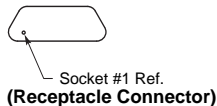

100 Contacts (Pin Connector)



ST1 — Straight Termination Configuration

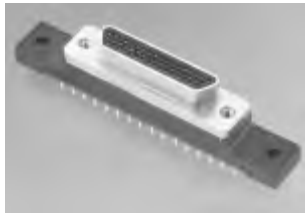

MIL-DTL-83513/22 through /27 configurations. 180° — Lo Profile termination configurations. See page 35 for M83513 cross references.

MCK Transition Blocks (Continued)

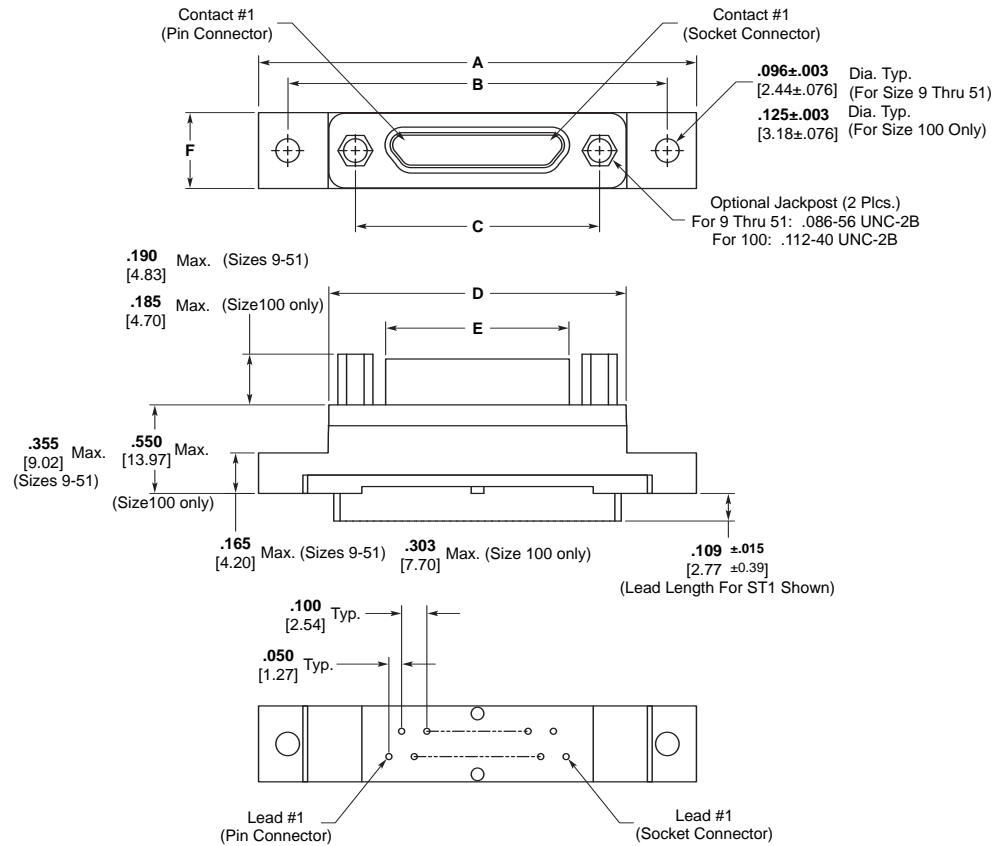

How To Specify

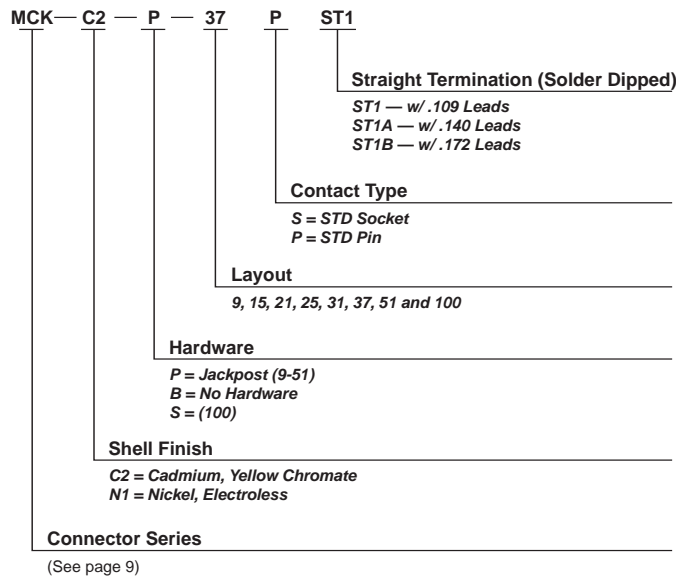

Notes:

1. For terminal identification see page 5048.
2. Grid pattern for all configurations is .100 x .100 [2.54 x 2.54].
3. Lead lengths shown are for ST1.
4. Items in bold italic are qualified to MIL-DTL-83513.

ST1 — Straight Termination Configuration (Continued)

Part Number	A Max.	B ± .007 [.178]	C ± .005 [.127]	D Max.	E Max.	F Max.
<i>MCK-**-*- 9PST1</i>	1.390 35.31	1.150 29.21	.565 14.35	.885 22.48	.3338 8.48	.308 7.83
<i>MCK-**-*- 9SST1</i>	1.390 35.31	1.150 29.21	.565 14.35	.885 22.48	.4018 10.21	.308 7.83
<i>MCK-**-*- 15PST1</i>	1.390 35.31	1.150 29.21	.715 18.16	.945 24.00	.4838 12.29	.308 7.83
<i>MCK-**-*- 15SST1</i>	1.390 35.31	1.150 29.21	.715 18.16	.945 24.00	.5518 14.02	.308 7.83
<i>MCK-**-*- 21PST1</i>	1.690 42.93	1.450 36.83	.865 21.97	1.185 30.10	.6338 16.10	.308 7.83
<i>MCK-**-*- 21SST1</i>	1.690 42.93	1.450 36.83	.865 21.97	1.185 30.10	.7018 17.83	.308 7.83
<i>MCK-**-*- 25PST1</i>	1.740 44.20	1.500 38.10	.965 24.51	1.275 32.39	.7338 18.64	.308 7.83
<i>MCK-**-*- 25SST1</i>	1.740 44.20	1.500 38.10	.965 24.51	1.275 32.39	.8018 20.37	.308 7.83
<i>MCK-**-*- 31PST1</i>	2.040 51.82	1.800 45.72	1.115 28.32	1.575 40.01	.8838 22.45	.308 7.83
<i>MCK-**-*- 31SST1</i>	2.040 51.82	1.800 45.72	1.115 28.32	1.575 40.01	.9518 24.18	.308 7.83
<i>MCK-**-*- 37PST1</i>	2.340 59.44	2.100 53.34	1.265 32.13	1.875 47.63	1.0338 26.26	.308 7.83
<i>MCK-**-*- 37SST1</i>	2.340 59.44	2.100 53.34	1.265 32.13	1.875 47.63	1.1018 27.99	.308 7.83
<i>MCK-**-*- 51PST1</i>	2.270 57.66	2.000 50.80	1.215 30.86	1.775 45.09	.9838 24.99	.351 8.92
<i>MCK-**-*- 51SST1</i>	2.280 57.91	2.000 50.80	1.215 30.86	1.775 45.09	1.0518 26.72	.351 8.92
<i>MCK-**-*- 100PST1</i>	3.250 82.55	2.800 71.12	1.800 45.72	2.585 65.66	1.3838 35.15	.460 11.68
<i>MCK-**-*- 100SST1</i>	3.250 82.55	2.800 71.12	1.800 45.72	2.585 65.66	1.508 38.30	.460 11.68

P = Pin, S = Socket

Note: Items in bold italic are qualified to MIL-DTL-83513.

ST1 — Straight Termination Configuration (Continued)

View is from mounting surface of connector. Plug configuration shown. For receptacle, use mirror image.

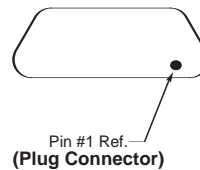
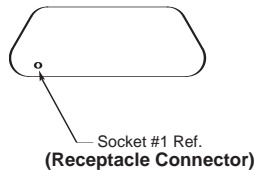
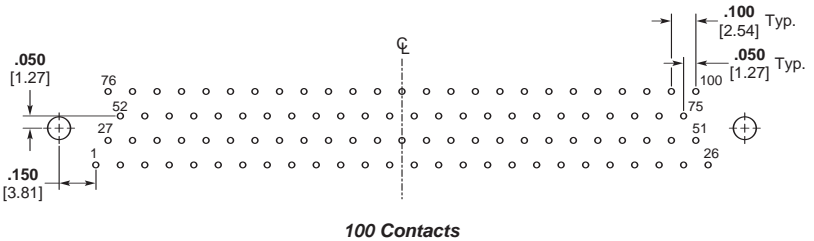
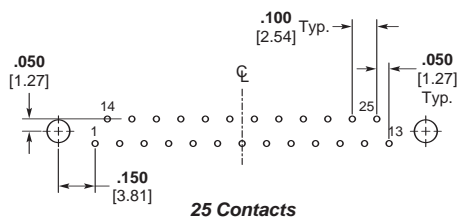
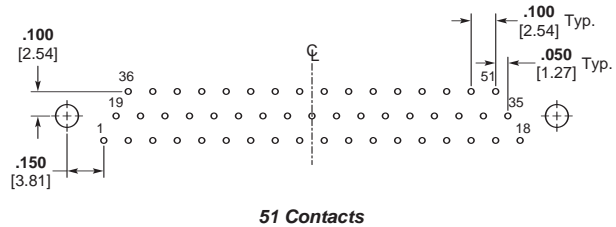
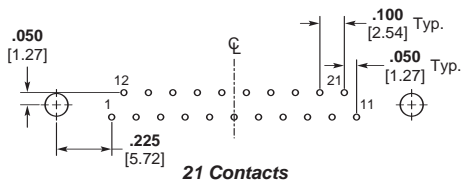
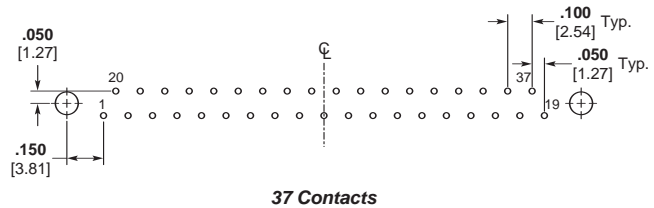
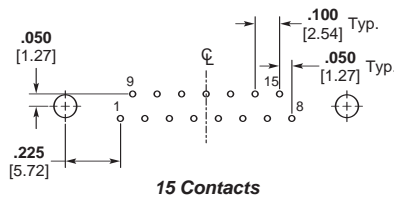
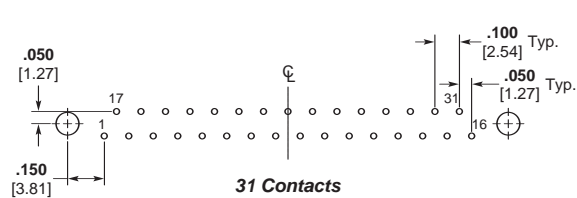
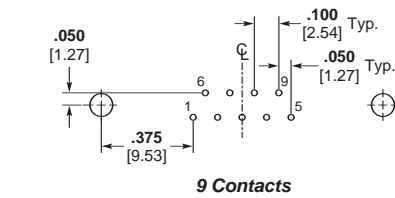

MCK ST2 Series Straight Mount PCB Connectors

MCK with Cactus Bend Termination



- Meets MIL-DTL-83513 Performance requirements
- Single metal shell with no Transition Block
- Low profile and light weight
- .100 [2.54] x .075 [1.91] grid pattern
- Design allows lower cost construction

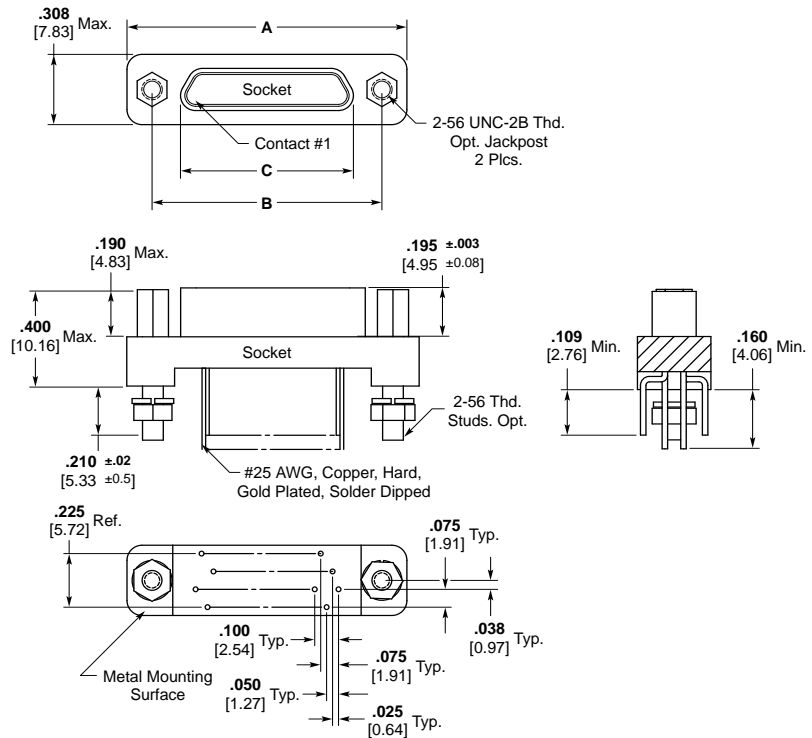
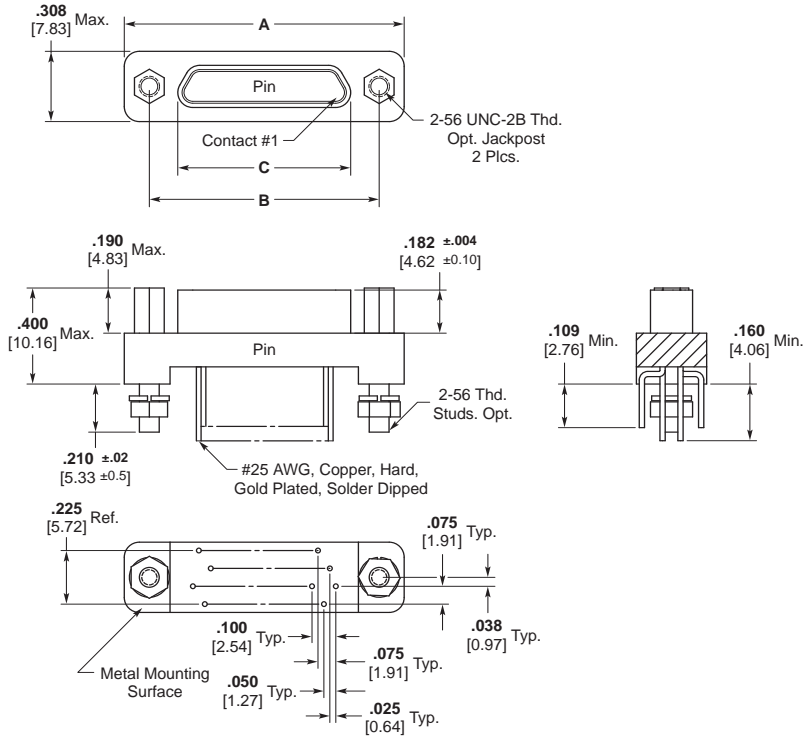

MCK ST2 Series Straight Mount PCB Connectors (Continued)

Part Number	A Max.	B ± .005	C Max.
MCK-**-*- 9 PST2	.785 19.94	.565 14.35	.333 8.46
MCK-**-*- 9 SST2	.785 19.94	.565 14.35	.402 10.21
MCK-**-*- 15 PST2	.935 23.75	.715 18.16	.483 12.27
MCK-**-*- 15 SST2	.935 23.75	.715 18.16	.552 14.02
MCK-**-*- 21 PST2	1.085 27.56	.865 21.97	.633 16.08
MCK-**-*- 21 SST2	1.085 27.56	.865 21.97	.702 17.83
MCK-**-*- 25 PST2	1.185 30.10	.965 24.51	.733 18.62
MCK-**-*- 25 SST2	1.185 30.10	.965 24.51	.802 20.37
MCK-**-*- 31 PST2	1.335 33.91	1.115 28.32	.883 22.43
MCK-**-*- 31 SST2	1.335 33.91	1.115 28.32	.952 24.18
MCK-**-*- 37 PST2	1.485 37.72	1.265 32.13	1.033 26.24
MCK-**-*- 37 SST2	1.485 37.72	1.265 32.13	1.102 27.99

How To Specify

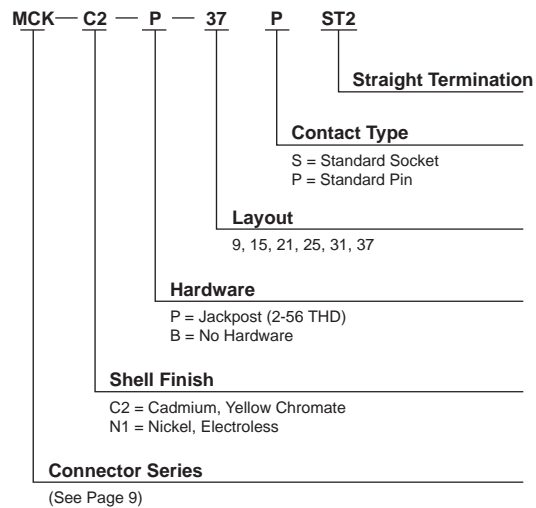

MCK ST2 Series Straight Mount PCB Connectors (Continued)

View is of mounting surface of pin connector

View is of mounting surface of socket connector

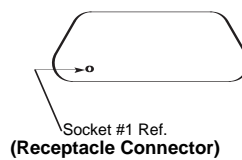
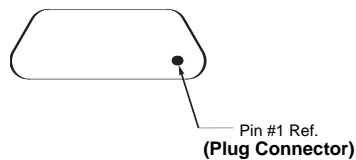
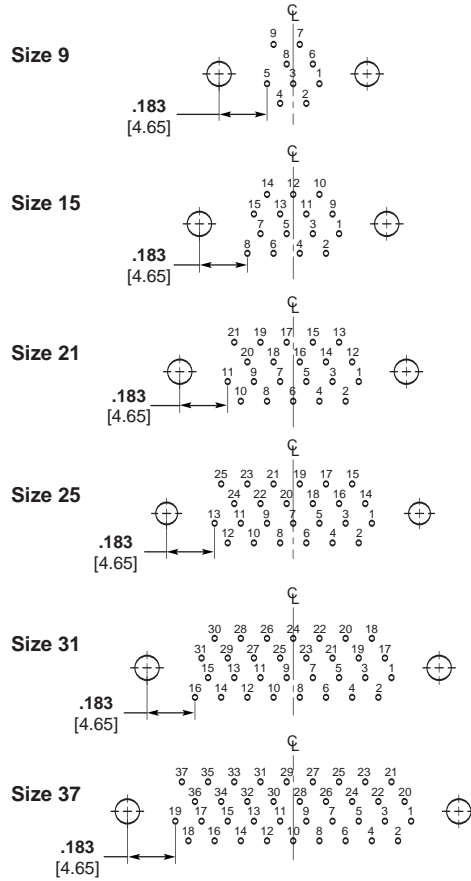
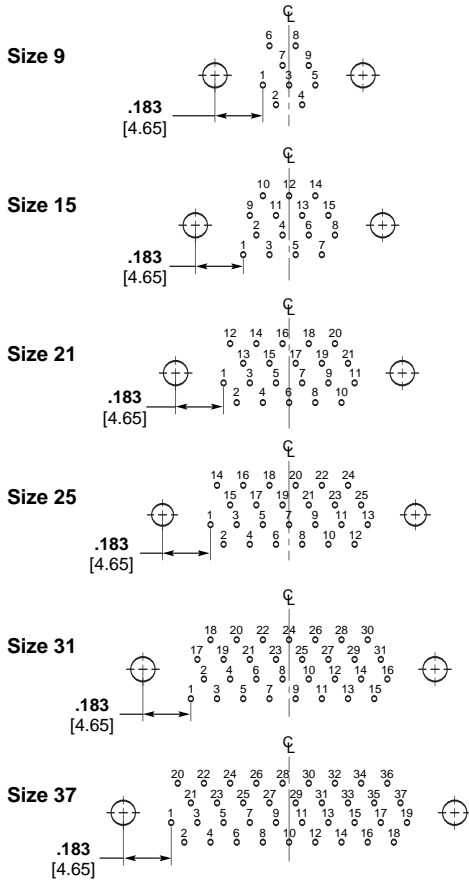

Technical & Performance Data

Screw Mount



The only metal shell connector that mates with all existing plastic types. This line is ideal for external use and other applications requiring frequent disconnect and remating. When durability and reliability are paramount the metal shell connector is unsurpassed — it eliminates the need for retrofitting where new metal shell varieties must mate with older plastic types.

Originally designed for military applications, they are currently used for commercial requirements, including computers.

MCDM Series Metal Shell Connectors

Performance

Contact Resistance — The average mated contact resistance is 4 milliohms, with a maximum value of 8 milliohms, using standard #24 solid copper leads when measured directly behind the crimp joints of the mated pin and socket contacts. The average resistance value at 100 microvolts is 4.8 milliohms.

Dielectric Withstanding Voltage (60 Hz rms room temperature) —

Solder Pots: 600 VAC at sea level; 150 VAC at 70,000 feet [21,336 m].
Wire Terminations: 750 VAC at sea level; 200 VAC at 70,000 feet [21,336 m]

Vibration (Per MIL-STD-202C, Method 204-A, Condition D) — No discontinuity in excess of 1 microsecond during twelve 20 minute sweeps from 10 to 2,000 CPS at .06 double amplitude or 20 G forces, whichever is less.

Corrosion Resistance (Per MIL-STD-202C, Method 101B, Condition B) — Both mated and unmated samples do not exceed the maximum allowable contact resistance

(8 milliohms) when subjected to the 48 hour salt spray test.

Durability — The contact resistance after 500 mating cycles is less than the maximum allowable, 8 milliohms.

Insulation Resistance — Greater than 5,000 megohms at room temperature for the materials listed under "Materials".

Maximum Current Carrying Capacity — No. 24 contact, 3 amperes. It must be recognized, however, that all the wires to a connector will not carry their maximum current under all environmental conditions due to wire temperature.

Contact Engaging and Separation Forces — 6 oz. [1.67N] maximum (eng.); 0.5 oz. [.14N] minimum (sep.).

Temperature Range (Operating) — Diallyl phthalate -67°F to 257°F [-55°C to +125°C].

Materials

Insulator — Diallyl phthalate per MIL-M-14, Type SDG-F or Liquid Crystal Polymer (LCP) per ASTM D5138.

Contacts — Pin Contact: Copper alloy and beryllium copper alloy make up the complete construction. Socket Contact: Copper alloy.

Body Shell — High grade aluminum alloy.

Finishes

Contacts — Standard finish is 0.000050 [0.00127] gold over copper flash per MIL-G-45204, Type II.

Body Shell — Electroless nickel per AMS 2404.

Note: Insulators are molded into their metal shells — No bonded joint is used.

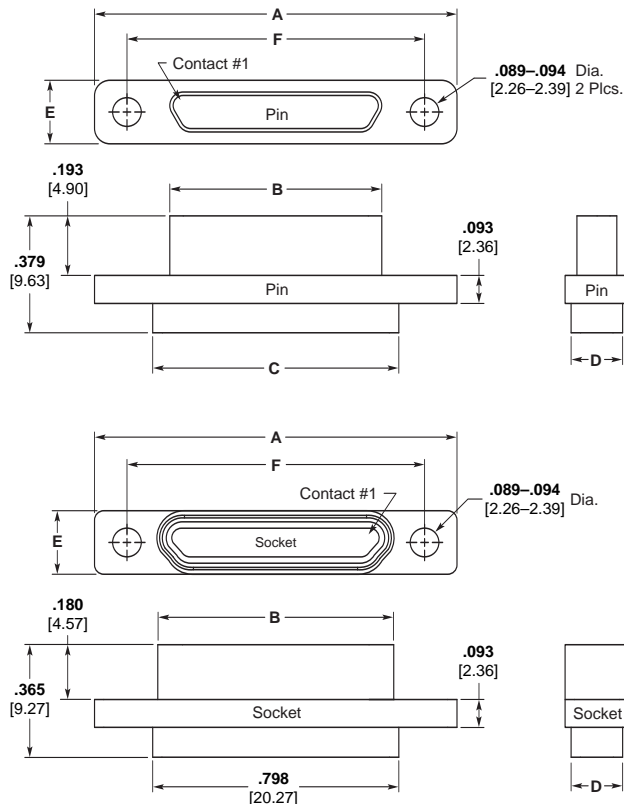

MCDM Series Metal Shell Connectors (Continued)

Screw Mount (Continued)

How To Specify

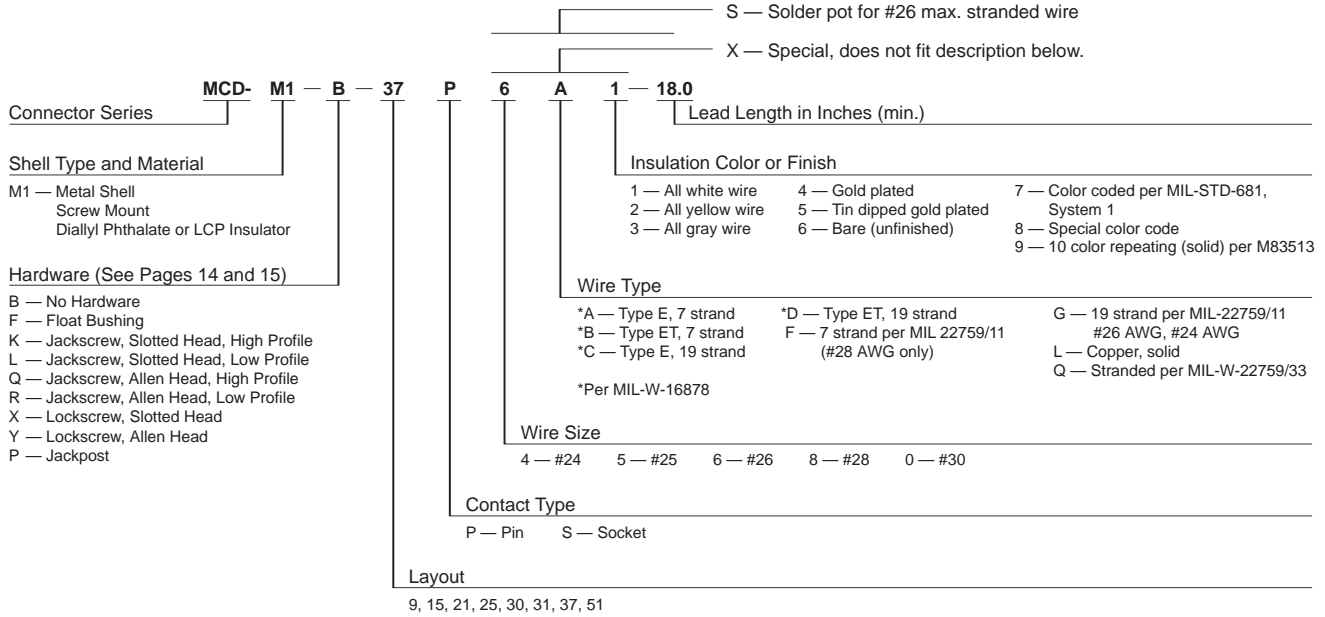

Part Number	A ± .005 [±.127]	B ± .005 [±.127]	C ± .010 [±.254]	D ± .010 [±.254]	E ± .005 [±.127]	F ± .005 [±.127]	Avg. Weight lbs. ± 5% [grams]
MCDM1-9P***	.780 19.81	.290 7.36	.398 10.11	.165 4.19	.208 5.28	.565 14.35	.003 1.36
MCDM1-9S***	.780 19.81	.365 9.27	.398 10.11	.165 4.19	.208 5.28	.565 14.35	.003 1.36
MCDM1-15P***	.930 23.62	.440 11.18	.548 13.92	.165 4.19	.208 5.28	.715 18.16	.004 1.81
MCDM1-15S***	.930 23.62	.515 13.08	.548 13.92	.165 4.19	.208 5.28	.715 18.16	.004 1.81
MCDM1-21P***	1.080 27.43	.590 14.99	.698 17.73	.165 4.19	.208 5.28	.865 21.97	.005 2.26
MCDM1-21S***	1.080 27.43	.665 16.89	.698 17.73	.165 4.19	.208 5.28	.865 21.97	.005 2.26
MCDM1-25P***	1.180 29.97	.690 17.53	.798 20.27	.165 4.19	.208 5.28	.965 24.51	.006 2.72
MCDM1-25S***	1.180 29.97	.765 19.43	.798 20.27	.165 4.19	.208 5.28	.965 24.51	.005 2.26
MCDM1-30P***	.930 23.62	.435 11.05	.548 13.92	.252 6.40	.295 7.49	.715 18.16	.007 3.17
MCDM1-30S***	.930 23.62	.515 13.08	.548 13.92	.252 6.40	.295 7.49	.715 18.16	.007 3.17
MCDM1-31P***	1.330 33.78	.840 21.34	.948 16.46	.165 4.19	.208 5.28	1.115 28.32	.007 3.17
MCDM1-31S***	1.330 33.78	.915 23.24	.948 16.46	.165 4.19	.208 5.28	1.115 28.32	.006 2.72
MCDM1-37P***	1.480 37.59	.990 25.15	1.098 27.89	.165 4.19	.208 5.28	1.270 32.26	.007 3.17
MCDM1-37S***	1.480 37.59	1.065 27.05	1.098 27.89	.165 4.19	.208 5.28	1.270 32.26	.007 3.17
MCDM1-51P***	1.430 36.32	.940 23.88	1.048 26.62	.208 5.28	.250 6.35	1.215 30.86	.009 4.08
MCDM1-51S***	1.430 36.32	1.015 25.78	1.048 26.62	.208 5.28	.250 6.35	1.215 30.86	.008 3.62

Note: Weight given is with .500 [12.7] uninsulated, solid, 24 AWG gold plated copper pigtailed.

MCDM Series Metal Shell RF COMBOMATE Connectors

Screw Mount Coaxial Terminations

Available *now* — RF Performance in standard subminiature rectangular connectors, with VSWR values of 1.01 to 1.10 in frequencies ranging in DC to 2.3 GHz. This is the COMBOMATE Connector.

This series of connectors incorporates the same metal shells and twist pin contacts used in the widely accepted, high reliability, MCDM Series.

The RF COMBOMATE Connector Series will accommodate RG 196 A/U or RG 178 B/U coaxial cable terminated in a unique, already tooled insert layouts. This feature results in savings in cost, time and space.

The RF COMBOMATE Connector Series will accommodate a maximum of 17 RG 196 A/U or RG 178 B/U cables in an area of less than .225 sq. inches [14.51 mm²]. Mixed layouts with coaxial terminations and standard AWG 24, 26 and 28 are also immediately available in 7 different shell sizes. The overall envelope and mounting dimensions of equivalent size of COMBOMATE Connectors are exactly the same as the standard MCDM Series.

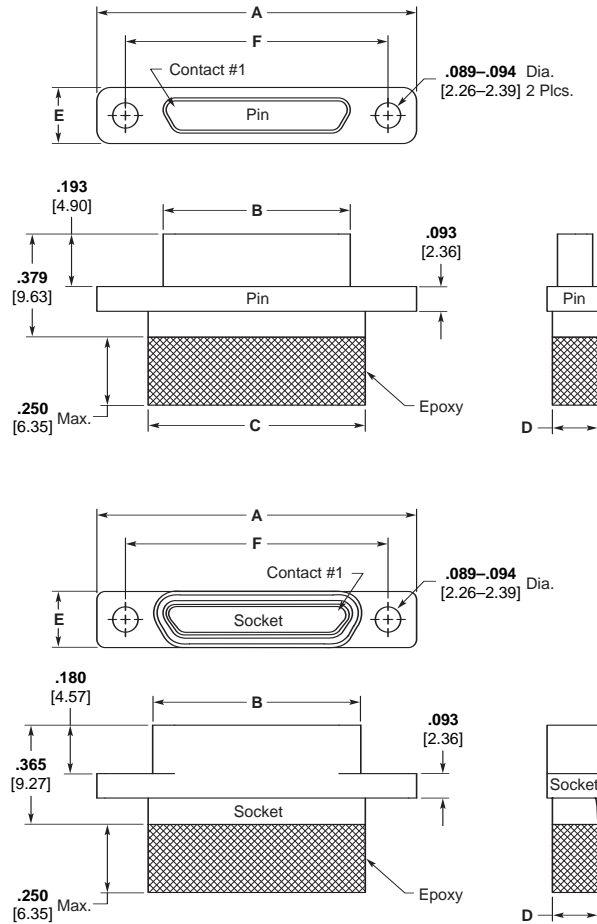

Performance Data — Coaxial Terminations

Impedance — 49.0 to 51.0 Ohms.

Voltage Standing Wave Ratio (VSWR) — 1.01:1 to 1.10:1 at frequency ranging in DC to 2.3 GHz.

Dielectric Withstanding Voltage (60 Hz rms room temperature) — 750 VAC at sea level; 200 VAC at 70,000 feet [21,336 m].

	(Actual Test Data) Crosstalk (Between Adjacent Lines)			
	1 to 2	2 to 3	3 to 4	4 to 5
30 MHz	60.0 db	59.8 db	60.7 db	60.0 db
100 MHz	49.1 db	48.3 db	51.7 db	50.6 db
175 MHz	42.6 db	41.4 db	47.2 db	47.0 db
500 MHz	38.0 db	38.8 db	39.5 db	40.0 db
1000 MHz	31.6 db	32.0 db	30.0 db	32.5 db
2000 MHz	22.4 db	22.5 db	22.3 db	20.8 db
3000 MHz	21.5 db	23.9 db	21.4 db	24.2 db

Sample	Insertion Loss				
	#1	#2	#3	#4	#5
30 MHz	.08 db	.08 db	.08 db	.08 db	.08 db
100 MHz	.24 db	.24 db	.25 db	.25 db	.25 db
175 MHz	.35 db	.36 db	.36 db	.34 db	.32 db
500 MHz	.58 db	.50 db	.60 db	.58 db	.48 db
1000 MHz	1.25 db	1.33 db	1.36 db	1.35 db	1.24 db
2000 MHz	1.48 db	1.71 db	1.42 db	1.40 db	1.45 db
3000 MHz	2.66 db	2.45 db	2.74 db	2.86 db	2.84 db

Note: Verification of all test data is on file at Tyco Electronics and is available upon request. All test runs using RG 196 A/U.

Screw Mount Coaxial Terminations (Continued)

How To Specify

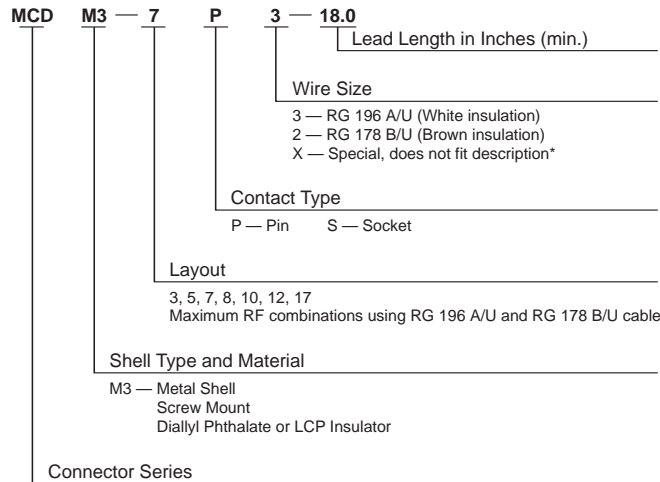

*Ordering Criteria: A wide variety of contact combinations, coaxial and power mixed, are available. Contact Tyco Electronics for additional arrangement numbers.

Part Number	A ± .005 [± .127]	B ± .005 [± .127]	C Max.	D Max.	E ± .005 [± .127]	F ± .005 [± .127]
MCDM3-3P**	.780 19.81	.290 7.36	.408 10.36	.200 5.08	.208 5.28	.565 14.35
MCDM3-3S**	.780 19.81	.365 9.27	.408 10.36	.200 5.08	.208 5.28	.565 14.35
MCDM3-5P**	.930 23.62	.440 11.18	.558 14.17	.200 5.08	.208 5.28	.715 18.16
MCDM3-5S**	.930 23.62	.515 13.08	.558 14.17	.200 5.08	.208 5.28	.715 18.16
MCDM3-7P**	1.080 27.43	.590 14.99	.708 17.98	.200 5.08	.208 5.28	.865 21.97
MCDM3-7S**	1.080 27.43	.665 16.89	.708 17.98	.200 5.08	.208 5.28	.865 21.97
MCDM3-8P**	1.180 29.97	.690 17.53	.808 20.52	.200 5.08	.208 5.28	.965 24.51
MCDM3-8S**	1.180 29.97	.765 19.43	.808 20.52	.200 5.08	.208 5.28	.965 24.51
MCDM3-10P**	1.330 33.78	.840 21.34	.958 24.33	.200 5.08	.208 5.28	1.115 28.32
MCDM3-10S**	1.330 33.78	.915 23.24	.958 24.33	.200 5.08	.208 5.28	1.115 28.32
MCDM3-12P**	1.480 37.59	.990 25.15	1.108 27.89	.200 5.08	.208 5.28	1.270 32.26
MCDM3-12S**	1.480 37.59	1.065 27.05	1.108 27.89	.200 5.08	.208 5.28	1.270 32.26
MCDM3-17P**	1.430 36.32	.940 23.88	1.058 26.87	.245 6.22	.250 6.35	1.215 30.86
MCDM3-17S**	1.430 36.32	1.015 25.78	1.058 26.87	.245 6.22	.250 6.35	1.215 30.86

MCDM Series Metal Shell RF COMBOMATE Connectors (Continued)

Contact Arrangement as Viewed from the Engaging Face of the Pin Side

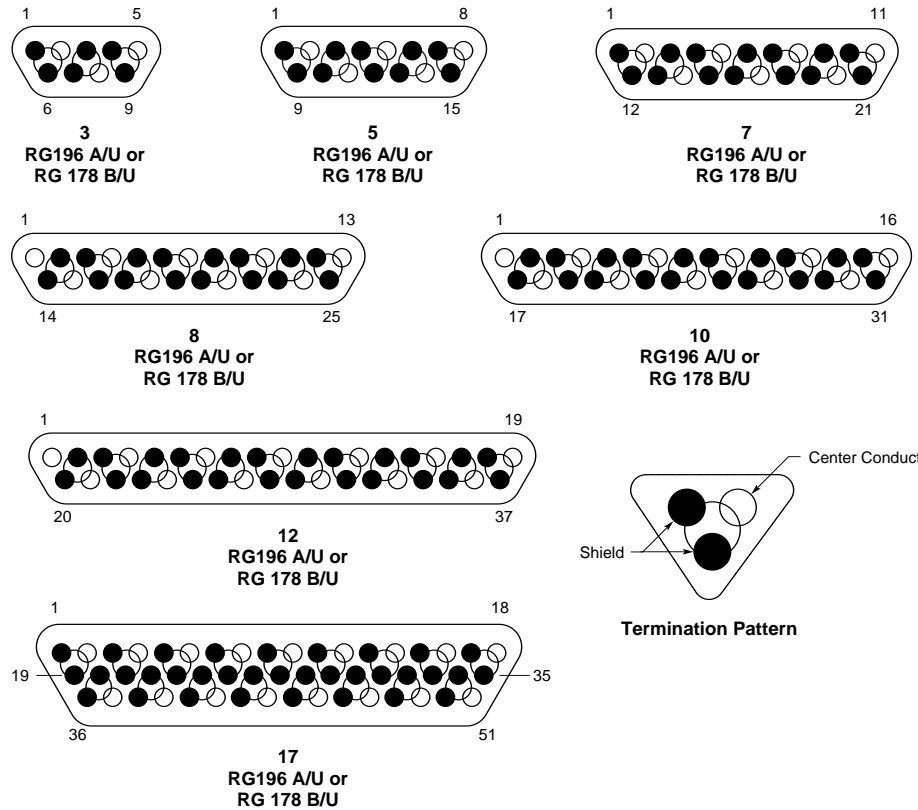

Note: The above contact arrangements are the maximum densities that can be obtained in each shell size when using RG 196 A/U or RG 178 B/U cable.

Panel Mounting Dimensions — MCDM

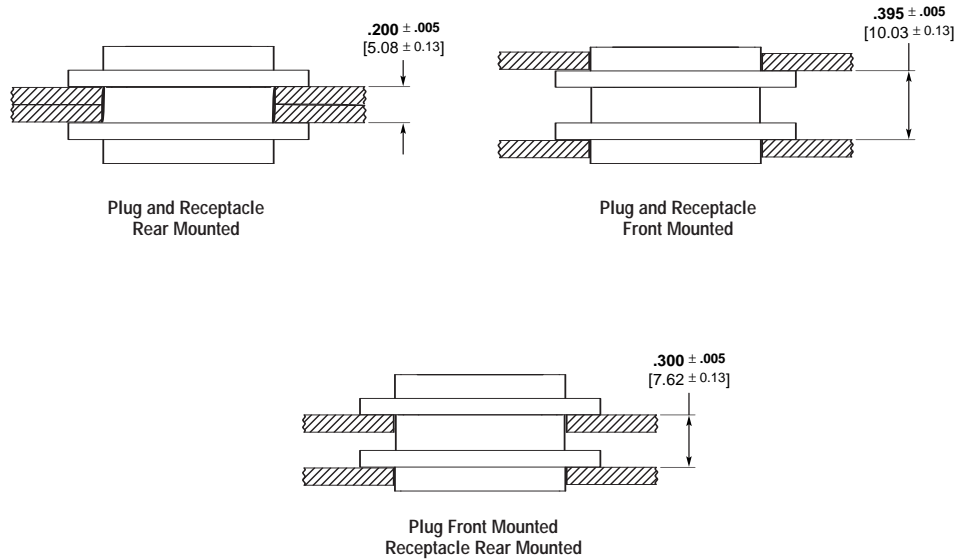

Panel Cutout Dimensions

Screw Mounting

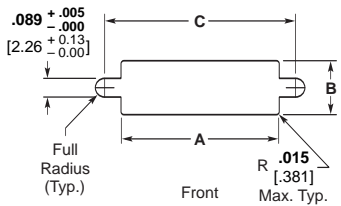

Figure 1

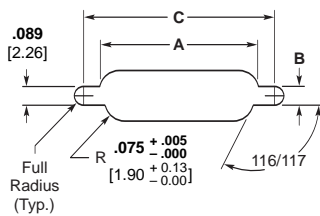

Figure 2

Note: Front mounting preferred.

Number of Contacts	Fig.	A		B		C	
		+ .004 [+ .102]	- .000 [- .000]	+ .004 [+ .102]	- .000 [- .000]	+ .005 [+ .127]	- .000 [- .000]
9	1	.412 [10.46]	.177 [4.50]	.570 [14.48]			
	2	.384 [9.75]	.222 [5.64]	.570 [14.48]			
15	1	.562 [14.27]	.177 [4.50]	.720 [18.29]			
	2	.534 [13.56]	.222 [5.64]	.720 [18.29]			
21	1	.712 [18.08]	.177 [4.50]	.870 [22.10]			
	2	.684 [17.37]	.222 [5.64]	.870 [22.10]			
25	1	.812 [20.62]	.177 [4.50]	.970 [24.64]			
	2	.784 [19.91]	.222 [5.64]	.970 [24.64]			
31	1	.962 [24.43]	.177 [4.50]	1.120 [28.45]			
	2	.934 [23.72]	.222 [5.64]	1.120 [28.45]			
37	1	1.112 [28.24]	.177 [4.50]	1.270 [32.26]			
	2	1.084 [27.53]	.222 [5.64]	1.270 [32.26]			
51	1	1.062 [26.97]	.224 [5.69]	1.220 [30.99]			
	2	1.034 [26.26]	.264 [6.71]	1.220 [30.99]			

MCK (Metal Shell)

Military Part No.	MICRODOT Part No.	Military Part No.	MICRODOT Part No.	Military Part No.	MICRODOT Part No.
M83513/01-A*	MCK--B- 9PS	M83513/03-E06*	MCK--B- 31P5L4-1.0	M83513/03-A14*	MCK--B- 9P6G9-72.0
M83513/01-B*	MCK--B- 15PS	M83513/03-F06*	MCK--B- 37P5L4-1.0	M83513/03-B14*	MCK--B- 15P6G9-72.0
M83513/01-C*	MCK--B- 21PS	M83513/03-G06*	MCK--B- 51P5L4-1.0	M83513/03-C14*	MCK--B- 21P6G9-72.0
M83513/01-D*	MCK--B- 25PS	M83513/03-H06*	MCK--B-100P5L4-1.0	M83513/03-D14*	MCK--B- 25P6G9-72.0
M83513/01-E*	MCK--B- 31PS	M83513/03-A07*	MCK--B- 9P5L5-0.5	M83513/03-E14*	MCK--B- 31P6G9-72.0
M83513/01-F*	MCK--B- 37PS	M83513/03-B07*	MCK--B- 15P5L5-0.5	M83513/03-F14*	MCK--B- 37P6G9-72.0
M83513/01-G*	MCK--B- 51PS	M83513/03-C07*	MCK--B- 21P5L5-0.5	M83513/03-G14*	MCK--B- 51P6G9-72.0
M83513/01-H*	MCK--B-100PS	M83513/03-D07*	MCK--B- 25P5L5-0.5	M83513/03-H14*	MCK--B-100P6G9-72.0
M83513/02-A*	MCK--B- 9SS	M83513/03-E07*	MCK--B- 31P5L5-0.5	M83513/03-A15*	MCK--B- 9P6Q1-72.0
M83513/02-B*	MCK--B- 15SS	M83513/03-F07*	MCK--B- 37P5L5-0.5	M83513/03-B15*	MCK--B- 15P6Q1-72.0
M83513/02-C*	MCK--B- 21SS	M83513/03-G07*	MCK--B- 51P5L5-0.5	M83513/03-C15*	MCK--B- 21P6Q1-72.0
M83513/02-D*	MCK--B- 25SS	M83513/03-H07*	MCK--B-100P5L5-0.5	M83513/03-D15*	MCK--B- 25P6Q1-72.0
M83513/02-E*	MCK--B- 31SS	M83513/03-A08*	MCK--B- 9P5L5-1.0	M83513/03-E15*	MCK--B- 31P6Q1-72.0
M83513/02-F*	MCK--B- 37SS	M83513/03-B08*	MCK--B- 15P5L5-1.0	M83513/03-F15*	MCK--B- 37P6Q1-72.0
M83513/02-G*	MCK--B- 51SS	M83513/03-C08*	MCK--B- 21P5L5-1.0	M83513/03-G15*	MCK--B- 51P6Q1-72.0
M83513/02-H*	MCK--B-100SS	M83513/03-D08*	MCK--B- 25P5L5-1.0	M83513/03-H15*	MCK--B-100P6Q1-72.0
M83513/03-A01*	MCK--B- 9P6G1-18.0	M83513/03-E08*	MCK--B- 31P5L5-1.0	M83513/03-A16*	MCK--B- 9P6Q9-72.0
M83513/03-B01*	MCK--B- 15P6G1-18.0	M83513/03-F08*	MCK--B- 37P5L5-1.0	M83513/03-B16*	MCK--B- 15P6Q9-72.0
M83513/03-C01*	MCK--B- 21P6G1-18.0	M83513/03-G08*	MCK--B- 51P5L5-1.0	M83513/03-C16*	MCK--B- 21P6Q9-72.0
M83513/03-D01*	MCK--B- 25P6G1-18.0	M83513/03-H08*	MCK--B-100P5L5-1.0	M83513/03-D16*	MCK--B- 25P6Q9-72.0
M83513/03-E01*	MCK--B- 31P6G1-18.0	M83513/03-A09*	MCK--B- 9P6Q1-18.0	M83513/03-E16*	MCK--B- 31P6Q9-72.0
M83513/03-F01*	MCK--B- 37P6G1-18.0	M83513/03-B09*	MCK--B- 15P6Q1-18.0	M83513/03-F16*	MCK--B- 37P6Q9-72.0
M83513/03-G01*	MCK--B- 51P6G1-18.0	M83513/03-C09*	MCK--B- 21P6Q1-18.0	M83513/03-G16*	MCK--B- 51P6Q9-72.0
M83513/03-H01*	MCK--B-100P6G1-18.0	M83513/03-D09*	MCK--B- 25P6Q1-18.0	M83513/03-H16*	MCK--B-100P6Q9-72.0
M83513/03-A02*	MCK--B- 9P6G1-36.0	M83513/03-E09*	MCK--B- 31P6Q1-18.0	M83513/04-A01*	MCK--B- 9S6G1-18.0
M83513/03-B02*	MCK--B- 15P6G1-36.0	M83513/03-F09*	MCK--B- 37P6Q1-18.0	M83513/04-B01*	MCK--B- 15S6G1-18.0
M83513/03-C02*	MCK--B- 21P6G1-36.0	M83513/03-G09*	MCK--B- 51P6Q1-18.0	M83513/04-C01*	MCK--B- 21S6G1-18.0
M83513/03-D02*	MCK--B- 25P6G1-36.0	M83513/03-H09*	MCK--B-100P6Q1-18.0	M83513/04-D01*	MCK--B- 25S6G1-18.0
M83513/03-E02*	MCK--B- 31P6G1-36.0	M83513/03-A10*	MCK--B- 9P6Q1-36.0	M83513/04-E01*	MCK--B- 31S6G1-18.0
M83513/03-F02*	MCK--B- 37P6G1-36.0	M83513/03-B10*	MCK--B- 15P6Q1-36.0	M83513/04-F01*	MCK--B- 37S6G1-18.0
M83513/03-G02*	MCK--B- 51P6G1-36.0	M83513/03-C10*	MCK--B- 21P6Q1-36.0	M83513/04-G01*	MCK--B- 51S6G1-18.0
M83513/03-H02*	MCK--B-100P6G1-36.0	M83513/03-D10*	MCK--B- 25P6Q1-36.0	M83513/04-H01*	MCK--B-100S6G1-18.0
M83513/03-A03*	MCK--B- 9P6G9-18.0	M83513/03-E10*	MCK--B- 31P6Q1-36.0	M83513/04-A02*	MCK--B- 9S6G1-36.0
M83513/03-B03*	MCK--B- 15P6G9-18.0	M83513/03-F10*	MCK--B- 37P6Q1-36.0	M83513/04-B02*	MCK--B- 15S6G1-36.0
M83513/03-C03*	MCK--B- 21P6G9-18.0	M83513/03-G10*	MCK--B- 51P6Q1-36.0	M83513/04-C02*	MCK--B- 21S6G1-36.0
M83513/03-D03*	MCK--B- 25P6G9-18.0	M83513/03-H10*	MCK--B-100P6Q1-36.0	M83513/04-D02*	MCK--B- 25S6G1-36.0
M83513/03-E03*	MCK--B- 31P6G9-18.0	M83513/03-A11*	MCK--B- 9P6Q9-18.0	M83513/04-E02*	MCK--B- 31S6G1-36.0
M83513/03-F03*	MCK--B- 37P6G9-18.0	M83513/03-B11*	MCK--B- 15P6Q9-18.0	M83513/04-F02*	MCK--B- 37S6G1-36.0
M83513/03-G03*	MCK--B- 51P6G9-18.0	M83513/03-C11*	MCK--B- 21P6Q9-18.0	M83513/04-G02*	MCK--B- 51S6G1-36.0
M83513/03-H03*	MCK--B-100P6G9-18.0	M83513/03-D11*	MCK--B- 25P6Q9-18.0	M83513/04-H02*	MCK--B-100S6G1-36.0
M83513/03-A04*	MCK--B- 9P6G9-36.0	M83513/03-E11*	MCK--B- 31P6Q9-18.0	M83513/04-A03*	MCK--B- 9S6G9-18.0
M83513/03-B04*	MCK--B- 15P6G9-36.0	M83513/03-F11*	MCK--B- 37P6Q9-18.0	M83513/04-B03*	MCK--B- 15S6G9-18.0
M83513/03-C04*	MCK--B- 21P6G9-36.0	M83513/03-G11*	MCK--B- 51P6Q9-18.0	M83513/04-C03*	MCK--B- 21S6G9-18.0
M83513/03-D04*	MCK--B- 25P6G9-36.0	M83513/03-H11*	MCK--B-100P6Q9-18.0	M83513/04-D03*	MCK--B- 25S6G9-18.0
M83513/03-E04*	MCK--B- 31P6G9-36.0	M83513/03-A12*	MCK--B- 9P6Q9-36.0	M83513/04-E03*	MCK--B- 31S6G9-18.0
M83513/03-F04*	MCK--B- 37P6G9-36.0	M83513/03-B12*	MCK--B- 15P6Q9-36.0	M83513/04-F03*	MCK--B- 37S6G9-18.0
M83513/03-G04*	MCK--B- 51P6G9-36.0	M83513/03-C12*	MCK--B- 21P6Q9-36.0	M83513/04-G03*	MCK--B- 51S6G9-18.0
M83513/03-H04*	MCK--B-100P6G9-36.0	M83513/03-D12*	MCK--B- 25P6Q9-36.0	M83513/04-H03*	MCK--B-100S6G9-18.0
M83513/03-A05*	MCK--B- 9P5L4-0.5	M83513/03-E12*	MCK--B- 31P6Q9-36.0	M83513/04-A04*	MCK--B- 9S6G9-36.0
M83513/03-B05*	MCK--B- 15P5L4-0.5	M83513/03-F12*	MCK--B- 37P6Q9-36.0	M83513/04-B04*	MCK--B- 15S6G9-36.0
M83513/03-C05*	MCK--B- 21P5L4-0.5	M83513/03-G12*	MCK--B- 51P6Q9-36.0	M83513/04-C04*	MCK--B- 21S6G9-36.0
M83513/03-D05*	MCK--B- 25P5L4-0.5	M83513/03-H12*	MCK--B-100P6Q9-36.0	M83513/04-D04*	MCK--B- 25S6G9-36.0
M83513/03-E05*	MCK--B- 31P5L4-0.5	M83513/03-A13*	MCK--B- 9P6G1-72.0	M83513/04-E04*	MCK--B- 31S6G9-36.0
M83513/03-F05*	MCK--B- 37P5L4-0.5	M83513/03-B13*	MCK--B- 15P6G1-72.0	M83513/04-F04*	MCK--B- 37S6G9-36.0
M83513/03-G05*	MCK--B- 51P5L4-0.5	M83513/03-C13*	MCK--B- 21P6G1-72.0	M83513/04-G04*	MCK--B- 51S6G9-36.0
M83513/03-H05*	MCK--B-100P5L4-0.5	M83513/03-D13*	MCK--B- 25P6G1-72.0	M83513/04-H04*	MCK--B-100S6G9-36.0
M83513/03-A06*	MCK--B- 9P5L4-1.0	M83513/03-E13*	MCK--B- 31P6G1-72.0	M83513/04-A05*	MCK--B- 9S5L4-0.5
M83513/03-B06*	MCK--B- 15P5L4-1.0	M83513/03-F13*	MCK--B- 37P6G1-72.0	M83513/04-B05*	MCK--B- 15S5L4-0.5
M83513/03-C06*	MCK--B- 21P5L4-1.0	M83513/03-G13*	MCK--B- 51P6G1-72.0	M83513/04-C05*	MCK--B- 21S5L4-0.5
M83513/03-D06*	MCK--B- 25P5L4-1.0	M83513/03-H13*	MCK--B-100P6G1-72.0	M83513/04-D05*	MCK--B- 25S5L4-0.5

MCK (Metal Shell) (Continued)

Military Part No.	MICRODOT Part No.	Military Part No.	MICRODOT Part No.	Military Part No.	MICRODOT Part No.
M83513/04-E05*	MCK-**-B- 31S5L4-0.5	M83513/04-D09*	MCK-**-B- 25S6Q1-18.0	M83513/04-C13*	MCK-**-B- 21S6G1-72.0
M83513/04-F05*	MCK-**-B- 37S5L4-0.5	M83513/04-E09*	MCK-**-B- 31S6Q1-18.0	M83513/04-D13*	MCK-**-B- 25S6G1-72.0
M83513/04-G05*	MCK-**-B- 51S5L4-0.5	M83513/04-F09*	MCK-**-B- 37S6Q1-18.0	M83513/04-E13*	MCK-**-B- 31S6G1-72.0
M83513/04-H05*	MCK-**-B-100S5L4-0.5	M83513/04-G09*	MCK-**-B- 51S6Q1-18.0	M83513/04-F13*	MCK-**-B- 37S6G1-72.0
M83513/04-A06*	MCK-**-B- 9S5L4-1.0	M83513/04-H09*	MCK-**-B-100S6Q1-18.0	M83513/04-G13*	MCK-**-B- 51S6G1-72.0
M83513/04-B06*	MCK-**-B- 15S5L4-1.0	M83513/04-A10*	MCK-**-B- 9S6Q1-36.0	M83513/04-H13*	MCK-**-B-100S6G1-72.0
M83513/04-C06*	MCK-**-B- 21S5L4-1.0	M83513/04-B10*	MCK-**-B- 15S6Q1-36.0	M83513/04-A14*	MCK-**-B- 9S6G9-72.0
M83513/04-D06*	MCK-**-B- 25S5L4-1.0	M83513/04-C10*	MCK-**-B- 21S6Q1-36.0	M83513/04-B14*	MCK-**-B- 15S6G9-72.0
M83513/04-E06*	MCK-**-B- 31S5L4-1.0	M83513/04-D10*	MCK-**-B- 25S6Q1-36.0	M83513/04-C14*	MCK-**-B- 21S6G9-72.0
M83513/04-F06*	MCK-**-B- 37S5L4-1.0	M83513/04-E10*	MCK-**-B- 31S6Q1-36.0	M83513/04-D14*	MCK-**-B- 25S6G9-72.0
M83513/04-G06*	MCK-**-B- 51S5L4-1.0	M83513/04-F10*	MCK-**-B- 37S6Q1-36.0	M83513/04-E14*	MCK-**-B- 31S6G9-72.0
M83513/04-H06*	MCK-**-B-100S5L4-1.0	M83513/04-G10*	MCK-**-B- 51S6Q1-36.0	M83513/04-F14*	MCK-**-B- 37S6G9-72.0
M83513/04-A07*	MCK-**-B- 9S5L5-0.5	M83513/04-H10*	MCK-**-B-100S6Q1-36.0	M83513/04-G14*	MCK-**-B- 51S6G9-72.0
M83513/04-B07*	MCK-**-B- 15S5L5-0.5	M83513/04-A11*	MCK-**-B- 9S6Q9-18.0	M83513/04-H14*	MCK-**-B-100S6G9-72.0
M83513/04-C07*	MCK-**-B- 21S5L5-0.5	M83513/04-B11*	MCK-**-B- 15S6Q9-18.0	M83513/04-A15*	MCK-**-B- 9S6Q1-72.0
M83513/04-D07*	MCK-**-B- 25S5L5-0.5	M83513/04-C11*	MCK-**-B- 21S6Q9-18.0	M83513/04-B15*	MCK-**-B- 15S6Q1-72.0
M83513/04-E07*	MCK-**-B- 31S5L5-0.5	M83513/04-D11*	MCK-**-B- 25S6Q9-18.0	M83513/04-C15*	MCK-**-B- 21S6Q1-72.0
M83513/04-F07*	MCK-**-B- 37S5L5-0.5	M83513/04-E11*	MCK-**-B- 31S6Q9-18.0	M83513/04-D15*	MCK-**-B- 25S6Q1-72.0
M83513/04-G07*	MCK-**-B- 51S5L5-0.5	M83513/04-F11*	MCK-**-B- 37S6Q9-18.0	M83513/04-E15*	MCK-**-B- 31S6Q1-72.0
M83513/04-H07*	MCK-**-B-100S5L5-0.5	M83513/04-G11*	MCK-**-B- 51S6Q9-18.0	M83513/04-F15*	MCK-**-B- 37S6Q1-72.0
M83513/04-A08*	MCK-**-B- 9S5L5-1.0	M83513/04-H11*	MCK-**-B-100S6Q9-18.0	M83513/04-G15*	MCK-**-B- 51S6Q1-72.0
M83513/04-B08*	MCK-**-B- 15S5L5-1.0	M83513/04-A12*	MCK-**-B- 9S6Q9-36.0	M83513/04-H15*	MCK-**-B-100S6Q1-72.0
M83513/04-C08*	MCK-**-B- 21S5L5-1.0	M83513/04-B12*	MCK-**-B- 15S6Q9-36.0	M83513/04-A16*	MCK-**-B- 9S6Q9-72.0
M83513/04-D08*	MCK-**-B- 25S5L5-1.0	M83513/04-C12*	MCK-**-B- 21S6Q9-36.0	M83513/04-B16*	MCK-**-B- 15S6Q9-72.0
M83513/04-E08*	MCK-**-B- 31S5L5-1.0	M83513/04-D12*	MCK-**-B- 25S6Q9-36.0	M83513/04-C16*	MCK-**-B- 21S6Q9-72.0
M83513/04-F08*	MCK-**-B- 37S5L5-1.0	M83513/04-E12*	MCK-**-B- 31S6Q9-36.0	M83513/04-D16*	MCK-**-B- 25S6Q9-72.0
M83513/04-G08*	MCK-**-B- 51S5L5-1.0	M83513/04-F12*	MCK-**-B- 37S6Q9-36.0	M83513/04-E16*	MCK-**-B- 31S6Q9-72.0
M83513/04-H08*	MCK-**-B-100S5L5-1.0	M83513/04-G12*	MCK-**-B- 51S6Q9-36.0	M83513/04-F16*	MCK-**-B- 37S6Q9-72.0
M83513/04-A09*	MCK-**-B- 9S6Q1-18.0	M83513/04-H12*	MCK-**-B-100S6Q9-36.0	M83513/04-G16*	MCK-**-B- 51S6Q9-72.0
M83513/04-B09*	MCK-**-B- 15S6Q1-18.0	M83513/04-A13*	MCK-**-B- 9S6G1-72.0	M83513/04-H16*	MCK-**-B-100S6Q9-72.0
M83513/04-C09*	MCK-**-B- 21S6Q1-18.0	M83513/04-B13*	MCK-**-B- 15S6G1-72.0		

*C = Cadmium or N = Nickel (space applications only)
 **C2 = Cadmium or N1 = Nickel (space applications only)

Hardware

Military Part No.	MICRODOT Part No.	Military Part No.	MICRODOT Part No.	Military Part No.	MICRODOT Part No.
M83513/05-02	"A. HD, J/S, L.F. #2"	M83513/05-05	"S. HD, J/S, L.F. #2"	M83513/05-07	"JACKPOST ASSY #2"
M83513/05-12	"A. HD, J/S, L.F. #4"	M83513/05-15	"S. HD, J/S, L.F. #4"	M83513/05-17	"JACKPOST ASSY, #4"
M83513/05-03	"A. HD, J/S,H.F. #2"	M83513/05-06	"S. HD, J/S, H.F. #2"		
M83513/05-13	"A. HD, J/S, H.F. #4"	M83513/05-16	"S. HD, J/S, H.F. #4"		

MCDR (Plastic Shell)

Military Part No.	MICRODOT Part No.	Military Part No.	MICRODOT Part No.	Military Part No.	MICRODOT Part No.
M83513/06-A	MCDR3-B- 9PS	M83513/07-G	MCDR3-B-51SS	M83513/08-F02	MCDR3-B-37P6G1-36.0
M83513/06-B	MCDR3-B-15PS	M83513/08-A01	MCDR3-B- 9P6G1-18.0	M83513/08-G02	MCDR3-B-51P6G1-36.0
M83513/06-C	MCDR3-B-21PS	M83513/08-B01	MCDR3-B-15P6G1-18.0	M83513/08-A03	MCDR3-B- 9P6G9-18.0
M83513/06-D	MCDR3-B-25PS	M83513/08-C01	MCDR3-B-21P6G1-18.0	M83513/08-B03	MCDR3-B-15P6G9-18.0
M83513/06-E	MCDR3-B-31PS	M83513/08-D01	MCDR3-B-25P6G1-18.0	M83513/08-C03	MCDR3-B-21P6G9-18.0
M83513/06-F	MCDR3-B-37PS	M83513/08-E01	MCDR3-B-31P6G1-18.0	M83513/08-D03	MCDR3-B-25P6G9-18.0
M83513/06-G	MCDR3-B-51PS	M83513/08-F01	MCDR3-B-37P6G1-18.0	M83513/08-E03	MCDR3-B-31P6G9-18.0
M83513/07-A	MCDR3-B- 9SS	M83513/08-G01	MCDR3-B-51P6G1-18.0	M83513/08-F03	MCDR3-B-37P6G9-18.0
M83513/07-B	MCDR3-B-15SS	M83513/08-A02	MCDR3-B- 9P6G1-36.0	M83513/08-G03	MCDR3-B-51P6G9-18.0
M83513/07-C	MCDR3-B-21SS	M83513/08-B02	MCDR3-B-15P6G1-36.0	M83513/08-A04	MCDR3-B- 9P6G9-36.0
M83513/07-D	MCDR3-B-25SS	M83513/08-C02	MCDR3-B-21P6G1-36.0	M83513/08-B04	MCDR3-B-15P6G9-36.0
M83513/07-E	MCDR3-B-31SS	M83513/08-D02	MCDR3-B-25P6G1-36.0	M83513/08-C04	MCDR3-B-21P6G9-36.0
M83513/07-F	MCDR3-B-37SS	M83513/08-E02	MCDR3-B-31P6G1-36.0	M83513/08-D04	MCDR3-B-25P6G9-36.0

MCDR (Plastic Shell) (Continued)

Military Part No.	MICRODOT Part No.
M83513/08-E04	MCDR3-B-31P6G9-36.0
M83513/08-F04	MCDR3-B-37P6G9-36.0
M83513/08-G04	MCDR3-B-51P6G9-36.0
M83513/08-A05	MCDR3-B- 9P5L4-0.5
M83513/08-B05	MCDR3-B-15P5L4-0.5
M83513/08-C05	MCDR3-B-21P5L4-0.5
M83513/08-D05	MCDR3-B-25P5L4-0.5
M83513/08-E05	MCDR3-B-31P5L4-0.5
M83513/08-F05	MCDR3-B-37P5L4-0.5
M83513/08-G05	MCDR3-B-51P5L4-0.5
M83513/08-A06	MCDR3-B- 9P5L4-1.0
M83513/08-B06	MCDR3-B-15P5L4-1.0
M83513/08-C06	MCDR3-B-21P5L4-1.0
M83513/08-D06	MCDR3-B-25P5L4-1.0
M83513/08-E06	MCDR3-B-31P5L4-1.0
M83513/08-F06	MCDR3-B-37P5L4-1.0
M83513/08-G06	MCDR3-B-51P5L4-1.0
M83513/08-A07	MCDR3-B- 9P5L5-0.5
M83513/08-B07	MCDR3-B-15P5L5-0.5
M83513/08-C07	MCDR3-B-21P5L5-0.5
M83513/08-D07	MCDR3-B-25P5L5-0.5
M83513/08-E07	MCDR3-B-31P5L5-0.5
M83513/08-F07	MCDR3-B-37P5L5-0.5
M83513/08-G07	MCDR3-B-51P5L5-0.5
M83513/08-A08	MCDR3-B- 9P5L5-1.0
M83513/08-B08	MCDR3-B-15P5L5-1.0
M83513/08-C08	MCDR3-B-21P5L5-1.0
M83513/08-D08	MCDR3-B-25P5L5-1.0
M83513/08-E08	MCDR3-B-31P5L5-1.0
M83513/08-F08	MCDR3-B-37P5L5-1.0
M83513/08-G08	MCDR3-B-51P5L5-1.0
M83513/08-A09	MCDR3-B- 9P6Q1-18.0
M83513/08-B09	MCDR3-B-15P6Q1-18.0
M83513/08-C09	MCDR3-B-21P6Q1-18.0
M83513/08-D09	MCDR3-B-25P6Q1-18.0
M83513/08-E09	MCDR3-B-31P6Q1-18.0
M83513/08-F09	MCDR3-B-37P6Q1-18.0
M83513/08-G09	MCDR3-B-51P6Q1-18.0
M83513/08-A10	MCDR3-B- 9P6Q1-36.0
M83513/08-B10	MCDR3-B-15P6Q1-36.0
M83513/08-C10	MCDR3-B-21P6Q1-36.0
M83513/08-D10	MCDR3-B-25P6Q1-36.0
M83513/08-E10	MCDR3-B-31P6Q1-36.0
M83513/08-F10	MCDR3-B-37P6Q1-36.0
M83513/08-G10	MCDR3-B-51P6Q1-36.0
M83513/08-A11	MCDR3-B- 9P6Q9-18.0
M83513/08-B11	MCDR3-B-15P6Q9-18.0
M83513/08-C11	MCDR3-B-21P6Q9-18.0
M83513/08-D11	MCDR3-B-25P6Q9-18.0
M83513/08-E11	MCDR3-B-31P6Q9-18.0
M83513/08-F11	MCDR3-B-37P6Q9-18.0
M83513/08-G11	MCDR3-B-51P6Q9-18.0
M83513/08-A12	MCDR3-B- 9P6Q9-36.0
M83513/08-B12	MCDR3-B-15P6Q9-36.0
M83513/08-C12	MCDR3-B-21P6Q9-36.0
M83513/08-D12	MCDR3-B-25P6Q9-36.0
M83513/08-E12	MCDR3-B-31P6Q9-36.0
M83513/08-F12	MCDR3-B-37P6Q9-36.0
M83513/08-G12	MCDR3-B-51P6Q9-36.0
M83513/08-A13	MCDR3-B- 9P6G1-72.0

Military Part No.	MICRODOT Part No.
M83513/08-B13	MCDR3-B-15P6G1-72.0
M83513/08-C13	MCDR3-B-21P6G1-72.0
M83513/08-D13	MCDR3-B-25P6G1-72.0
M83513/08-E13	MCDR3-B-31P6G1-72.0
M83513/08-F13	MCDR3-B-37P6G1-72.0
M83513/08-G13	MCDR3-B-51P6G1-72.0
M83513/08-A14	MCDR3-B- 9P6G9-72.0
M83513/08-B14	MCDR3-B-15P6G9-72.0
M83513/08-C14	MCDR3-B-21P6G9-72.0
M83513/08-D14	MCDR3-B-25P6G9-72.0
M83513/08-E14	MCDR3-B-31P6G9-72.0
M83513/08-F14	MCDR3-B-37P6G9-72.0
M83513/08-G14	MCDR3-B-51P6G9-72.0
M83513/08-A15	MCDR3-B- 9P6Q1-72.0
M83513/08-B15	MCDR3-B-15P6Q1-72.0
M83513/08-C15	MCDR3-B-21P6Q1-72.0
M83513/08-D15	MCDR3-B-25P6Q1-72.0
M83513/08-E15	MCDR3-B-31P6Q1-72.0
M83513/08-F15	MCDR3-B-37P6Q1-72.0
M83513/08-G15	MCDR3-B-51P6Q1-72.0
M83513/08-A16	MCDR3-B- 9P6Q9-72.0
M83513/08-B16	MCDR3-B-15P6Q9-72.0
M83513/08-C16	MCDR3-B-21P6Q9-72.0
M83513/08-D16	MCDR3-B-25P6Q9-72.0
M83513/08-E16	MCDR3-B-31P6Q9-72.0
M83513/08-F16	MCDR3-B-37P6Q9-72.0
M83513/08-G16	MCDR3-B-51P6Q9-72.0
M83513/09-A01	MCDR3-B- 9S6G1-18.0
M83513/09-B01	MCDR3-B-15S6G1-18.0
M83513/09-C01	MCDR3-B-21S6G1-18.0
M83513/09-D01	MCDR3-B-25S6G1-18.0
M83513/09-E01	MCDR3-B-31S6G1-18.0
M83513/09-F01	MCDR3-B-37S6G1-18.0
M83513/09-G01	MCDR3-B-51S6G1-18.0
M83513/09-A02	MCDR3-B- 9S6G1-36.0
M83513/09-B02	MCDR3-B-15S6G1-36.0
M83513/09-C02	MCDR3-B-21S6G1-36.0
M83513/09-D02	MCDR3-B-25S6G1-36.0
M83513/09-E02	MCDR3-B-31S6G1-36.0
M83513/09-F02	MCDR3-B-37S6G1-36.0
M83513/09-G02	MCDR3-B-51S6G1-36.0
M83513/09-A03	MCDR3-B- 9S6G9-18.0
M83513/09-B03	MCDR3-B-15S6G9-18.0
M83513/09-C03	MCDR3-B-21S6G9-18.0
M83513/09-D03	MCDR3-B-25S6G9-18.0
M83513/09-E03	MCDR3-B-31S6G9-18.0
M83513/09-F03	MCDR3-B-37S6G9-18.0
M83513/09-G03	MCDR3-B-51S6G9-18.0
M83513/09-A04	MCDR3-B- 9S6G9-36.0
M83513/09-B04	MCDR3-B-15S6G9-36.0
M83513/09-C04	MCDR3-B-21S6G9-36.0
M83513/09-D04	MCDR3-B-25S6G9-36.0
M83513/09-E04	MCDR3-B-31S6G9-36.0
M83513/09-F04	MCDR3-B-37S6G9-36.0
M83513/09-G04	MCDR3-B-51S6G9-36.0
M83513/09-A05	MCDR3-B- 9S5L4-0.5
M83513/09-B05	MCDR3-B-15S5L4-0.5
M83513/09-C05	MCDR3-B-21S5L4-0.5
M83513/09-D05	MCDR3-B-25S5L4-0.5
M83513/09-E05	MCDR3-B-31S5L4-0.5

Military Part No.	MICRODOT Part No.
M83513/09-F05	MCDR3-B-37S5L4-0.5
M83513/09-G05	MCDR3-B-51S5L4-0.5
M83513/09-A06	MCDR3-B- 9S5L4-1.0
M83513/09-B06	MCDR3-B-15S5L4-1.0
M83513/09-C06	MCDR3-B-21S5L4-1.0
M83513/09-D06	MCDR3-B-25S5L4-1.0
M83513/09-E06	MCDR3-B-31S5L4-1.0
M83513/09-F06	MCDR3-B-37S5L4-1.0
M83513/09-G06	MCDR3-B-51S5L4-1.0
M83513/09-A07	MCDR3-B- 9S5L5-0.5
M83513/09-B07	MCDR3-B-15S5L5-0.5
M83513/09-C07	MCDR3-B-21S5L5-0.5
M83513/09-D07	MCDR3-B-25S5L5-0.5
M83513/09-E07	MCDR3-B-31S5L5-0.5
M83513/09-F07	MCDR3-B-37S5L5-0.5
M83513/09-G07	MCDR3-B-51S5L5-0.5
M83513/09-A08	MCDR3-B- 9S5L5-1.0
M83513/09-B08	MCDR3-B-15S5L5-1.0
M83513/09-C08	MCDR3-B-21S5L5-1.0
M83513/09-D08	MCDR3-B-25S5L5-1.0
M83513/09-E08	MCDR3-B-31S5L5-1.0
M83513/09-F08	MCDR3-B-37S5L5-1.0
M83513/09-G08	MCDR3-B-51S5L5-1.0
M83513/09-A09	MCDR3-B- 9S6Q1-18.0
M83513/09-B09	MCDR3-B-15S6Q1-18.0
M83513/09-C09	MCDR3-B-21S6Q1-18.0
M83513/09-D09	MCDR3-B-25S6Q1-18.0
M83513/09-E09	MCDR3-B-31S6Q1-18.0
M83513/09-F09	MCDR3-B-37S6Q1-18.0
M83513/09-G09	MCDR3-B-51S6Q1-18.0
M83513/09-A10	MCDR3-B- 9S6Q1-36.0
M83513/09-B10	MCDR3-B-15S6Q1-36.0
M83513/09-C10	MCDR3-B-21S6Q1-36.0
M83513/09-D10	MCDR3-B-25S6Q1-36.0
M83513/09-E10	MCDR3-B-31S6Q1-36.0
M83513/09-F10	MCDR3-B-37S6Q1-36.0
M83513/09-G10	MCDR3-B-51S6Q1-36.0
M83513/09-A11	MCDR3-B- 9S6Q9-18.0
M83513/09-B11	MCDR3-B-15S6Q9-18.0
M83513/09-C11	MCDR3-B-21S6Q9-18.0
M83513/09-D11	MCDR3-B-25S6Q9-18.0
M83513/09-E11	MCDR3-B-31S6Q9-18.0
M83513/09-F11	MCDR3-B-37S6Q9-18.0
M83513/09-G11	MCDR3-B-51S6Q9-18.0
M83513/09-A12	MCDR3-B- 9S6Q9-36.0
M83513/09-B12	MCDR3-B-15S6Q9-36.0
M83513/09-C12	MCDR3-B-21S6Q9-36.0
M83513/09-D12	MCDR3-B-25S6Q9-36.0
M83513/09-E12	MCDR3-B-31S6Q9-36.0
M83513/09-F12	MCDR3-B-37S6Q9-36.0
M83513/09-G12	MCDR3-B-51S6Q9-36.0
M83513/09-A13	MCDR3-B- 9S6G1-72.0
M83513/09-B13	MCDR3-B-15S6G1-72.0
M83513/09-C13	MCDR3-B-21S6G1-72.0
M83513/09-D13	MCDR3-B-25S6G1-72.0
M83513/09-E13	MCDR3-B-31S6G1-72.0
M83513/09-F13	MCDR3-B-37S6G1-72.0
M83513/09-G13	MCDR3-B-51S6G1-72.0
M83513/09-A14	MCDR3-B- 9S6G9-72.0
M83513/09-B14	MCDR3-B-15S6G9-72.0

MCDR (Plastic Shell) (Continued)

Military Part No.	MICRODOT Part No.
M83513/09-C14	MCDR3-B-21S6G9-72.0
M83513/09-D14	MCDR3-B-25S6G9-72.0
M83513/09-E14	MCDR3-B-31S6G9-72.0
M83513/09-F14	MCDR3-B-37S6G9-72.0
M83513/09-G14	MCDR3-B-51S6G9-72.0
M83513/09-A15	MCDR3-B- 9S6Q1-72.0
M83513/09-B15	MCDR3-B-15S6Q1-72.0

Military Part No.	MICRODOT Part No.
M83513/09-C15	MCDR3-B-21S6Q1-72.0
M83513/09-D15	MCDR3-B-25S6Q1-72.0
M83513/09-E15	MCDR3-B-31S6Q1-72.0
M83513/09-F15	MCDR3-B-37S6Q1-72.0
M83513/09-G15	MCDR3-B-51S6Q1-72.0
M83513/09-A16	MCDR3-B- 9S6Q9-72.0
M83513/09-B16	MCDR3-B-15S6Q9-72.0

Military Part No.	MICRODOT Part No.
M83513/09-C16	MCDR3-B-21S6Q9-72.0
M83513/09-D16	MCDR3-B-25S6Q9-72.0
M83513/09-E16	MCDR3-B-31S6Q9-72.0
M83513/09-F16	MCDR3-B-37S6Q9-72.0
M83513/09-G16	MCDR3-B-51S6Q9-72.0

MCK (Metal Shell)

Military Part No.	MICRODOT Part No.
M83513/10-A01*N	MCK--B- 9PRT1
M83513/10-B01*N	MCK--B- 15PRT1
M83513/10-C01*N	MCK--B- 21PRT1
M83513/10-D01*N	MCK--B- 25PRT1
M83513/10-E01*N	MCK--B- 31PRT1
M83513/10-F01*N	MCK--B- 37PRT1
M83513/10-A01*P	MCK--P- 9PRT1
M83513/10-B01*P	MCK--P- 15PRT1
M83513/10-C01*P	MCK--P- 21PRT1
M83513/10-D01*P	MCK--P- 25PRT1
M83513/10-E01*P	MCK--P- 31PRT1
M83513/10-F01*P	MCK--P- 37PRT1
M83513/10-A02*N	MCK--B- 9PRT1A
M83513/10-B02*N	MCK--B- 15PRT1A
M83513/10-C02*N	MCK--B- 21PRT1A
M83513/10-D02*N	MCK--B- 25PRT1A
M83513/10-E02*N	MCK--B- 31PRT1A
M83513/10-F02*N	MCK--B- 37PRT1A
M83513/10-A02*P	MCK--P- 9PRT1A
M83513/10-B02*P	MCK--P- 15PRT1A
M83513/10-C02*P	MCK--P- 21PRT1A
M83513/10-D02*P	MCK--P- 25PRT1A
M83513/10-E02*P	MCK--P- 31PRT1A
M83513/10-F02*P	MCK--P- 37PRT1A
M83513/10-A03*N	MCK--B- 9PRT1B
M83513/10-B03*N	MCK--B- 15PRT1B
M83513/10-C03*N	MCK--B- 21PRT1B
M83513/10-D03*N	MCK--B- 25PRT1B
M83513/10-E03*N	MCK--B- 31PRT1B
M83513/10-F03*N	MCK--B- 37PRT1B
M83513/10-A03*P	MCK--P- 9PRT1B
M83513/10-B03*P	MCK--P- 15PRT1B
M83513/10-C03*P	MCK--P- 21PRT1B
M83513/10-D03*P	MCK--P- 25PRT1B
M83513/10-E03*P	MCK--P- 31PRT1B
M83513/10-F03*P	MCK--P- 37PRT1B
M83513/11-G01*N	MCK--B- 51PRT1
M83513/11-G01*P	MCK--P- 51PRT1
M83513/11-G02*N	MCK--B- 51PRT1A
M83513/11-G02*P	MCK--P- 51PRT1A
M83513/11-G03*N	MCK--B- 51PRT1B
M83513/11-G03*P	MCK--P- 51PRT1B
M83513/12-H01*N	MCK--B-100PRT1
M83513/12-H01*P	MCK--P-100PRT1
M83513/12-H02*N	MCK--B-100PRT1A
M83513/12-H02*P	MCK--P-100PRT1A
M83513/12-H03*N	MCK--B-100PRT1B

Military Part No.	MICRODOT Part No.
M83513/12-H03*P	MCK--P-100PRT1B
M83513/13-A01*N	MCK--B- 9SRT1
M83513/13-B01*N	MCK--B- 15SRT1
M83513/13-C01*N	MCK--B- 21SRT1
M83513/13-D01*N	MCK--B- 25SRT1
M83513/13-E01*N	MCK--B- 31SRT1
M83513/13-F01*N	MCK--B- 37SRT1
M83513/13-A01*P	MCK--P- 9SRT1
M83513/13-B01*P	MCK--P- 15SRT1
M83513/13-C01*P	MCK--P- 21SRT1
M83513/13-D01*P	MCK--P- 25SRT1
M83513/13-E01*P	MCK--P- 31SRT1
M83513/13-F01*P	MCK--P- 37SRT1
M83513/13-A02*N	MCK--B- 9SRT1A
M83513/13-B02*N	MCK--B- 15SRT1A
M83513/13-C02*N	MCK--B- 21SRT1A
M83513/13-D02*N	MCK--B- 25SRT1A
M83513/13-E02*N	MCK--B- 31SRT1A
M83513/13-F02*N	MCK--B- 37SRT1A
M83513/13-A02*P	MCK--P- 9SRT1A
M83513/13-B02*P	MCK--P- 15SRT1A
M83513/13-C02*P	MCK--P- 21SRT1A
M83513/13-D02*P	MCK--P- 25SRT1A
M83513/13-E02*P	MCK--P- 31SRT1A
M83513/13-F02*P	MCK--P- 37SRT1A
M83513/13-A03*N	MCK--B- 9SRT1B
M83513/13-B03*N	MCK--B- 15SRT1B
M83513/13-C03*N	MCK--B- 21SRT1B
M83513/13-D03*N	MCK--B- 25SRT1B
M83513/13-E03*N	MCK--B- 31SRT1B
M83513/13-F03*N	MCK--B- 37SRT1B
M83513/13-A03*P	MCK--P- 9SRT1B
M83513/13-B03*P	MCK--P- 15SRT1B
M83513/13-C03*P	MCK--P- 21SRT1B
M83513/13-D03*P	MCK--P- 25SRT1B
M83513/13-E03*P	MCK--P- 31SRT1B
M83513/13-F03*P	MCK--P- 37SRT1B
M83513/14-G01*N	MCK--B- 51SRT1
M83513/14-G01*P	MCK--P- 51SRT1
M83513/14-G02*N	MCK--B- 51SRT1A
M83513/14-G02*P	MCK--P- 51SRT1A
M83513/14-G03*N	MCK--B- 51SRT1B
M83513/14-G03*P	MCK--P- 51SRT1B
M83513/15-H01*N	MCK--B-100SRT1
M83513/15-H01*P	MCK--P-100SRT1
M83513/15-H02*N	MCK--B-100SRT1A
M83513/15-H02*P	MCK--P-100SRT1A

Military Part No.	MICRODOT Part No.
M83513/15-H03*N	MCK--B-100SRT1B
M83513/15-H03*P	MCK--P-100SRT1B
M83513/16-A01*N	MCK--B- 9PRT3
M83513/16-B01*N	MCK--B- 15PRT3
M83513/16-C01*N	MCK--B- 21PRT3
M83513/16-D01*N	MCK--B- 25PRT3
M83513/16-E01*N	MCK--B- 31PRT3
M83513/16-F01*N	MCK--B- 37PRT3
M83513/16-A01*P	MCK--P- 9PRT3
M83513/16-B01*P	MCK--P- 15PRT3
M83513/16-C01*P	MCK--P- 21PRT3
M83513/16-D01*P	MCK--P- 25PRT3
M83513/16-E01*P	MCK--P- 31PRT3
M83513/16-F01*P	MCK--P- 37PRT3
M83513/16-A02*N	MCK--B- 9PRT3A
M83513/16-B02*N	MCK--B- 15PRT3A
M83513/16-C02*N	MCK--B- 21PRT3A
M83513/16-D02*N	MCK--B- 25PRT3A
M83513/16-E02*N	MCK--B- 31PRT3A
M83513/16-F02*N	MCK--B- 37PRT3A
M83513/16-A02*P	MCK--P- 9PRT3A
M83513/16-B02*P	MCK--P- 15PRT3A
M83513/16-C02*P	MCK--P- 21PRT3A
M83513/16-D02*P	MCK--P- 25PRT3A
M83513/16-E02*P	MCK--P- 31PRT3A
M83513/16-F02*P	MCK--P- 37PRT3A
M83513/16-A03*N	MCK--B- 9PRT3B
M83513/16-B03*N	MCK--B- 15PRT3B
M83513/16-C03*N	MCK--B- 21PRT3B
M83513/16-D03*N	MCK--B- 25PRT3B
M83513/16-E03*N	MCK--B- 31PRT3B
M83513/16-F03*N	MCK--B- 37PRT3B
M83513/16-A03*P	MCK--P- 9PRT3B
M83513/16-B03*P	MCK--P- 15PRT3B
M83513/16-C03*P	MCK--P- 21PRT3B
M83513/16-D03*P	MCK--P- 25PRT3B
M83513/16-E03*P	MCK--P- 31PRT3B
M83513/16-F03*P	MCK--P- 37PRT3B
M83513/17-G01*N	MCK--B- 51PRT3
M83513/17-G01*P	MCK--P- 51PRT3
M83513/17-G02*N	MCK--B- 51PRT3A
M83513/17-G02*P	MCK--P- 51PRT3A
M83513/17-G03*N	MCK--B- 51PRT3B
M83513/17-G03*P	MCK--P- 51PRT3B
M83513/18-H01*N	MCK--B-100PRT3
M83513/18-H01*P	MCK--P-100PRT3
M83513/18-H02*N	MCK--B-100PRT3A

MCK (Metal Shell) (Continued)

Military Part No.	MICRODOT Part No.	Military Part No.	MICRODOT Part No.	Military Part No.	MICRODOT Part No.
M83515/18-H02*P	MCK-**-P-100PRT3A	M83513/21-H03*N	MCK-**-B-100SRT3B	M83513/24-H03*P	MCK-**-P-100PST1B
M83513/18-H03*N	MCK-**-B-100PRT3B	M83513/21-H03*P	MCK-**-P-100SRT3B	M83513/25-A01*N	MCK-**-B- 9SST1
M83513/18-H03*P	MCK-**-P-100PRT3B	M83513/22-A01*N	MCK-**-B- 9PST1	M83513/25-B01*N	MCK-**-B- 15SST1
M83513/19-A01*N	MCK-**-B- 9SRT3	M83513/22-B01*N	MCK-**-B- 15PST1	M83513/25-C01*N	MCK-**-B- 21SST1
M83513/19-B01*N	MCK-**-B- 15SRT3	M83513/22-C01*N	MCK-**-B- 21PST1	M83513/25-D01*N	MCK-**-B- 25SST1
M83513/19-C01*N	MCK-**-B- 21SRT3	M83513/22-D01*N	MCK-**-B- 25PST1	M83513/25-E01*N	MCK-**-B- 31SST1
M83513/19-D01*N	MCK-**-B- 25SRT3	M83513/22-E01*N	MCK-**-B- 31PST1	M83513/25-F01*N	MCK-**-B- 37SST1
M83513/19-E01*N	MCK-**-B- 31SRT3	M83513/22-F01*N	MCK-**-B- 37PST1	M83513/25-A01*P	MCK-**-P- 9SST1
M83513/19-F01*N	MCK-**-B- 37SRT3	M83513/22-A01*P	MCK-**-P- 9PST1	M83513/25-B01*P	MCK-**-P- 15SST1
M83513/19-A01*P	MCK-**-P- 9SRT3	M83513/22-B01*P	MCK-**-P- 15PST1	M83513/25-C01*P	MCK-**-P- 21SST1
M83513/19-B01*P	MCK-**-P- 15SRT3	M83513/22-C01*P	MCK-**-P- 21PST1	M83513/25-D01*P	MCK-**-P- 25SST1
M83513/19-C01*P	MCK-**-P- 21SRT3	M83513/22-D01*P	MCK-**-P- 25PST1	M83513/25-E01*P	MCK-**-P- 31SST1
M83513/19-D01*P	MCK-**-P- 25SRT3	M83513/22-E01*P	MCK-**-P- 31PST1	M83513/25-F01*P	MCK-**-P- 37SST1
M83513/19-E01*P	MCK-**-P- 31SRT3	M83513/22-F01*P	MCK-**-P- 37PST1	M83513/25-A02*N	MCK-**-B- 9SST1A
M83513/19-F01*P	MCK-**-P- 37SRT3	M83513/22-A02*N	MCK-**-B- 9PST1A	M83513/25-B02*N	MCK-**-B- 15SST1A
M83513/19-A02*N	MCK-**-B- 9SRT3A	M83513/22-B02*N	MCK-**-B- 15PST1A	M83513/25-C02*N	MCK-**-B- 21SST1A
M83513/19-B02*N	MCK-**-B- 15SRT3A	M83513/22-C02*N	MCK-**-B- 21PST1A	M83513/25-D02*N	MCK-**-B- 25SST1A
M83513/19-C02*N	MCK-**-B- 21SRT3A	M83513/22-D02*N	MCK-**-B- 25PST1A	M83513/25-E02*N	MCK-**-B- 31SST1A
M83513/19-D02*N	MCK-**-B- 25SRT3A	M83513/22-E02*N	MCK-**-B- 31PST1A	M83513/25-F02*N	MCK-**-B- 37SST1A
M83513/19-E02*N	MCK-**-B- 31SRT3A	M83513/22-F02*N	MCK-**-B- 37PST1A	M83513/25-A02*P	MCK-**-P- 9SST1A
M83513/19-F02*N	MCK-**-B- 37SRT3A	M83513/22-A02*P	MCK-**-P- 9PST1A	M83513/25-B02*P	MCK-**-P- 15SST1A
M83513/19-A02*P	MCK-**-P- 9SRT3A	M83513/22-B02*P	MCK-**-P- 15PST1A	M83513/25-C02*P	MCK-**-P- 21SST1A
M83513/19-B02*P	MCK-**-P- 15SRT3A	M83513/22-C02*P	MCK-**-P- 21PST1A	M83513/25-D02*P	MCK-**-P- 25SST1A
M83513/19-C02*P	MCK-**-P- 21SRT3A	M83513/22-D02*P	MCK-**-P- 25PST1A	M83513/25-E02*P	MCK-**-P- 31SST1A
M83513/19-D02*P	MCK-**-P- 25SRT3A	M83513/22-E02*P	MCK-**-P- 31PST1A	M83513/25-F02*P	MCK-**-P- 37SST1A
M83513/19-E02*P	MCK-**-P- 31SRT3A	M83513/22-F02*P	MCK-**-P- 37PST1A	M83513/25-A03*N	MCK-**-B- 9SST1B
M83513/19-F02*P	MCK-**-P- 37SRT3A	M83513/22-A03*N	MCK-**-B- 9PST1B	M83513/25-B03*N	MCK-**-B- 15SST1B
M83513/19-A03*N	MCK-**-B- 9SRT3B	M83513/22-B03*N	MCK-**-B- 15PST1B	M83513/25-C03*N	MCK-**-B- 21SST1B
M83513/19-B03*N	MCK-**-B- 15SRT3B	M83513/22-C03*N	MCK-**-B- 21PST1B	M83513/25-D03*N	MCK-**-B- 25SST1B
M83513/19-C03*N	MCK-**-B- 21SRT3B	M83513/22-D03*N	MCK-**-B- 25PST1B	M83513/25-E03*N	MCK-**-B- 31SST1B
M83513/19-D03*N	MCK-**-B- 25SRT3B	M83513/22-E03*N	MCK-**-B- 31PST1B	M83513/25-F03*N	MCK-**-B- 37SST1B
M83513/19-E03*N	MCK-**-B- 31SRT3B	M83513/22-F03*N	MCK-**-B- 37PST1B	M83513/25-A03*P	MCK-**-P- 9SST1B
M83513/19-F03*N	MCK-**-B- 37SRT3B	M83513/22-A03*P	MCK-**-P- 9PST1B	M83513/25-B03*P	MCK-**-P- 15SST1B
M83513/19-A03*P	MCK-**-P- 9SRT3B	M83513/22-B03*P	MCK-**-P- 15PST1B	M83513/25-C03*P	MCK-**-P- 21SST1B
M83513/19-B03*P	MCK-**-P- 15SRT3B	M83513/22-C03*P	MCK-**-P- 21PST1B	M83513/25-D03*P	MCK-**-P- 25SST1B
M83513/19-C03*P	MCK-**-P- 21SRT3B	M83513/22-D03*P	MCK-**-P- 25PST1B	M83513/25-E03*P	MCK-**-P- 31SST1B
M83513/19-D03*P	MCK-**-P- 25SRT3B	M83513/22-E03*P	MCK-**-P- 31PST1B	M83513/25-F03*P	MCK-**-P- 37SST1B
M83513/19-E03*P	MCK-**-P- 31SRT3B	M83513/22-F03*P	MCK-**-P- 37PST1B	M83513/26-G01*N	MCK-**-B- 51SST1
M83513/19-F03*P	MCK-**-P- 37SRT3B	M83513/23-G01*N	MCK-**-B- 51PST1	M83513/26-G01*P	MCK-**-P- 51SST1
M83513/20-G01*N	MCK-**-B- 51SRT3	M83513/23-G01*P	MCK-**-P- 51PST1	M83513/26-G02*N	MCK-**-B- 51SST1A
M83513/20-G01*P	MCK-**-P- 51SRT3	M83513/23-G02*N	MCK-**-B- 51PST1A	M83513/26-G02*P	MCK-**-P- 51SST1A
M83513/20-G02*N	MCK-**-B- 51SRT3A	M83513/23-G02*P	MCK-**-P- 51PST1A	M83513/26-G03*N	MCK-**-B- 51SST1B
M83513/20-G02*P	MCK-**-P- 51SRT3A	M83513/23-G03*N	MCK-**-B- 51PST1B	M83513/26-G03*P	MCK-**-P- 51SST1B
M83513/20-G03*N	MCK-**-B- 51SRT3B	M83513/23-G03*P	MCK-**-P- 51PST1B	M83513/27-H01*N	MCK-**-B-100SST1
M83513/20-G03*P	MCK-**-P- 51SRT3B	M83513/24-H01*N	MCK-**-B-100PST1	M83513/27-H01*P	MCK-**-P-100SST1
M83513/21-H01*N	MCK-**-B-100SRT3	M83513/24-H01*P	MCK-**-P-100PST1	M83513/27-H02*N	MCK-**-B-100SST1A
M83513/21-H01*P	MCK-**-P-100SRT3	M83513/24-H02*N	MCK-**-B-100PST1A	M83515/27-H02*P	MCK-**-P-100SST1A
M83513/21-H02*N	MCK-**-B-100SRT3A	M83515/24-H02*P	MCK-**-P-100PST1A	M83513/27-H03*N	MCK-**-B-100SST1B
M83515/21-H02*P	MCK-**-P-100SRT3A	M83513/24-H03*N	MCK-**-B-100PST1B	M83513/27-H03*P	MCK-**-P-100SST1B

*C = Cadmium or N = Nickel (space applications only)
 **C2 = Cadmium or N1 = Nickel (space applications only)

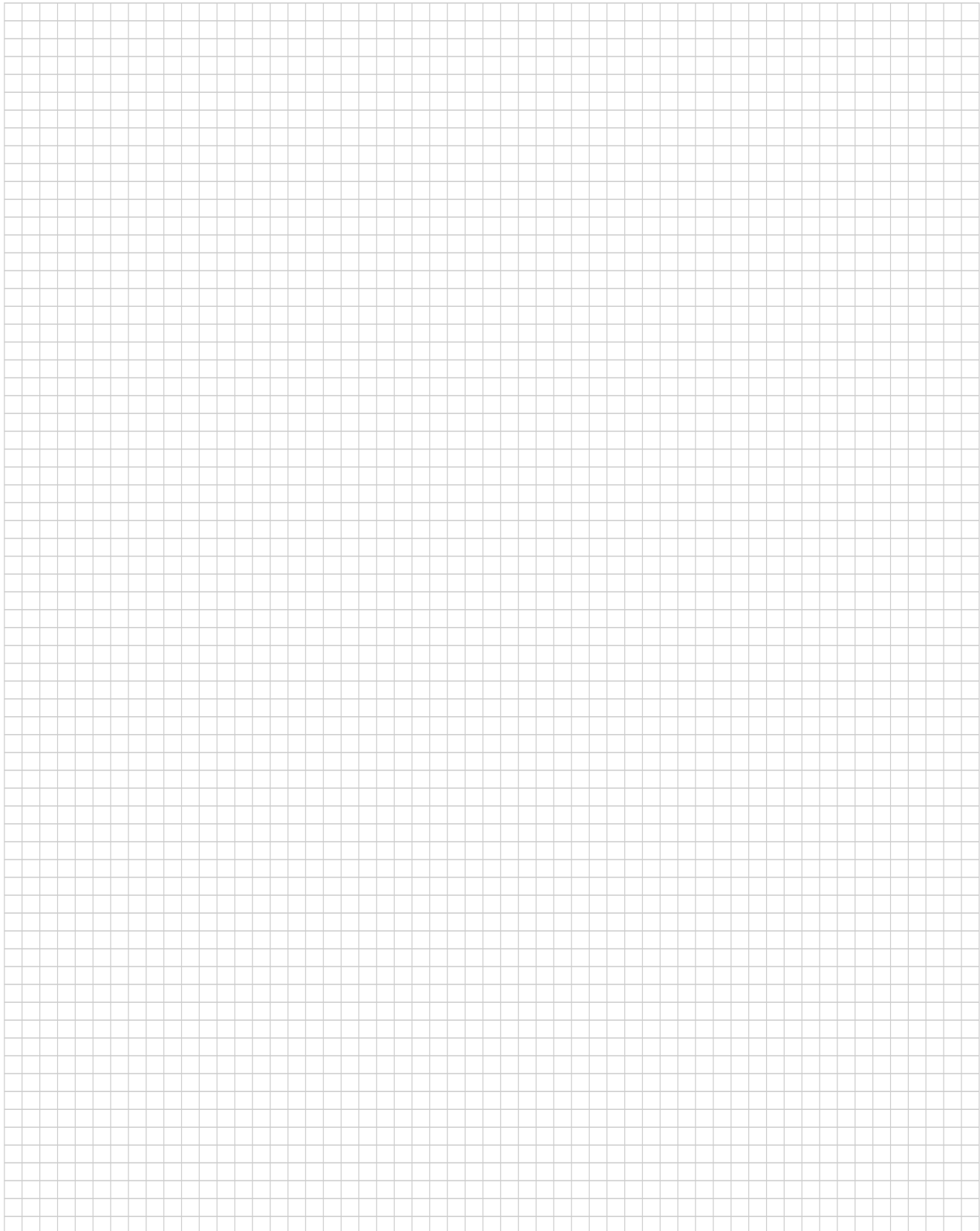

Introduction

Product Facts

- Designed for both military and commercial applications
- Well-suited for external conditions
- Precise contact alignment with extremely low engaging forces
- Product offering consists of metal shell, plastic shell, panel mount, printed circuit board and strip connectors
- Metal shell connector promotes high durability and reliability



Rectangular Connectors

2

Twist Pin contact High Density Microminiature Connectors described in this catalog comprise a complete contact system which is adaptable to a numerous variety of form factors. Precise contact alignment, with extremely low engaging forces, results from the manner in which the Twist Pin contact system is packaged — by constructing the male contact as a breathing helical spring, electrical contact is achieved at many points around the periphery of the pin bundle.

Featured in this catalog is the twist pin contact line, which accommodates round wire and Flat Conductor Cable (FCC), Edgeboard Connectors.

Applications requiring frequent mating and disconnect call for the metal shell connector version. This style connector promotes high durability and reliability.

Designed for both military and commercial applications, this latest innovation is especially well-suited to use in external conditions.

This catalog also features light-weight plastic

connectors in a strip (MCS) format as well as JACKMATE Connectors (MCJ Series) format for small package application requiring high reliability.

Edgeboard applications are covered in this catalog with a special High Density Standard Module (HDSM) Connector as well as MIL-DTL-55302 (MCEM) Connectors. The high mating forces of these larger connectors are greatly reduced with the use of the low force twist pins and sockets which are standard for this product line.

Twist Pin Contact Data**Twist Pin — 24 gauge
Pin and Socket Contacts**

The contact spring member normally found in socket contacts has been eliminated by creating a breathing helical spring principle on the pin contact — smaller, more durable contacts can be manufactured economically.



Wire range 24-36 AWG solid & stranded.

MCE Series Plastic Shell Edgeboard Connectors

Plastic Shell Edge Board Connectors

Designed for commercial applications requiring frequent disconnect and connect, including data recorders and computers. Mother board connector can be ordered to fit any pattern on your circuit board.

This new connector features the proven twist pin contact with precision contact alignment with extremely low engaging forces.

Units are available with contacts as few as 40 and as many as 110. Wire sizes 28 through 24, any type of plating or color coding, any kind of wire termination including wire wrap — a high degree of flexibility for your military or commercial application.

Two hexagonal polarizing keys can provide up to 36 different key combinations are supplied.

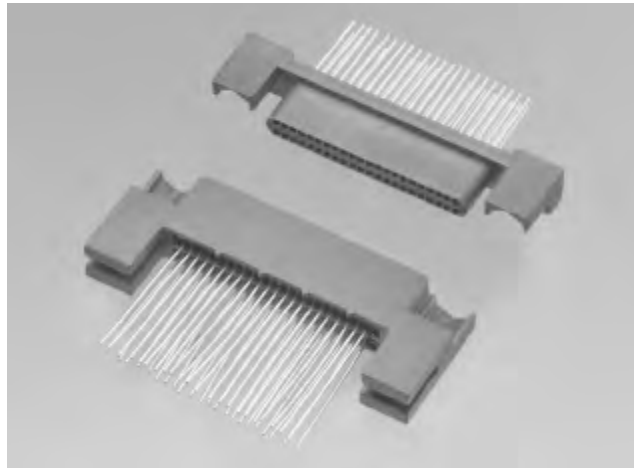

40 Contacts

Technical & Performance Data — Twist Pin Plastic Shell Connectors

Electrical

Contact Resistance — The average mated contact resistance is 4 milliohms, with a maximum value of 8 milliohms, using standard 24 AWG solid copper leads when measured directly behind the crimp joints of the mated pin and socket contacts. The average resistance value at 100 microvolts is 4.8 milliohms.

Dielectric Withstanding Voltage — 800 VAC RMS at sea level (600 for solder pots); 200 VAC RMS at 70,000 feet [21,336m] (150 for solder pots).

Corrosion Resistance (Per MIL-STD-202C, Method 101B, Condition B) — Both mated and unmated samples do not exceed the maximum allowable contact resistance (8 milliohms) when subjected to the 48 hour salt spray test.

Durability — The contact resistance after 500 mating cycles is less than the maximum allowable, 8 milliohms.

Insulation Resistance — Greater than 5,000 megohms at room temperature.

Maximum Current Carrying Capacity — No. 24 contact 3 amperes. It must be recognized however, that all the wires to a connector will not carry their maximum current under all environmental conditions due to wire temperature.

Mechanical

Contact Engaging & Separation Forces — 8.0 oz. max. [2.24N] (eng.), 0.5 oz. min. [.14N] (sep.)

Environmental

Temperature Range (Operating) — -67°F to 257°F [-55° C to +125°C].

Vibration (Per MIL-STD-202C, Method 204A, Condition D) — No discontinuity in excess of 1 μ sec. during twelve 20 minute sweeps from 10 to 2000 CPS at .06 double amplitude or 20 G forces, whichever is less.

Materials

Insulator — Liquid Crystal Polymer (LCP) per ASTM D5138 or Polyphenylene Sulfide per MIL-M-24519.

Contacts — Pin-contact: Copper alloy and beryllium copper alloy make up the complete construction. Socket contact: Copper alloy.

Hardware — Corrosion resistant stainless steel.

Finishes

Insulator — None.

Contacts — Standard finish is 0.000050 [0.00127] gold over copper flash per MIL-G-45204, Type II.

Hardware — Passivated per QQ-P-35.

Mother Board (Pin Side)

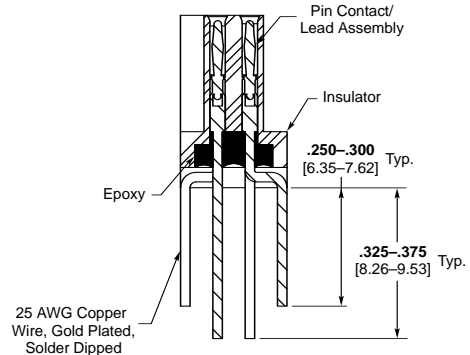
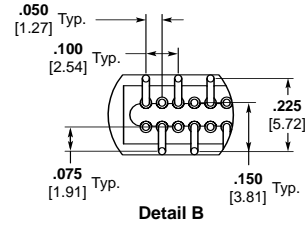
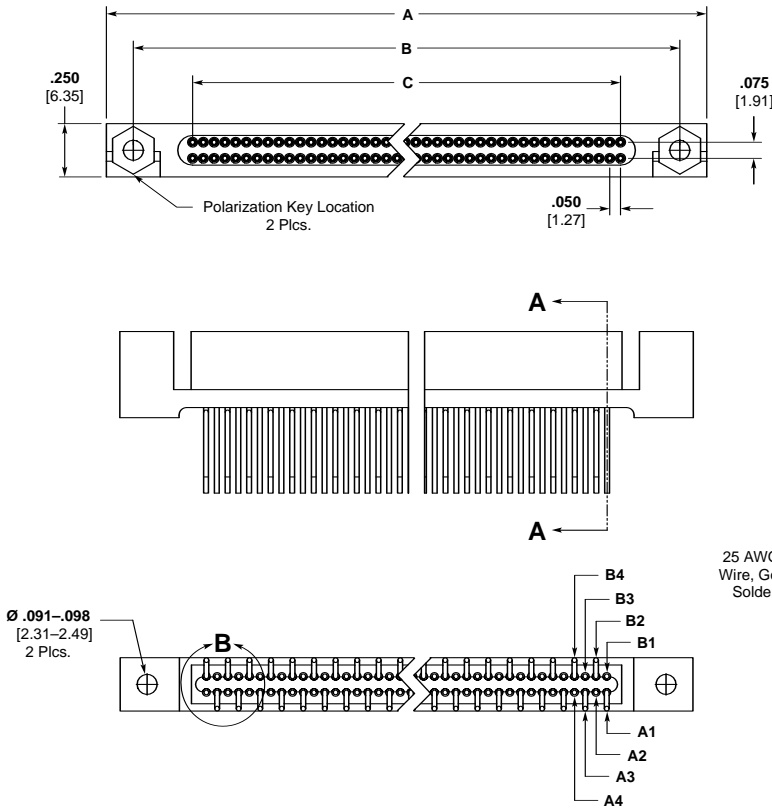

Section A-A



Hex Polarizing Key
2 Supplied (Loose Packed)

Daughter Board (Socket Side)

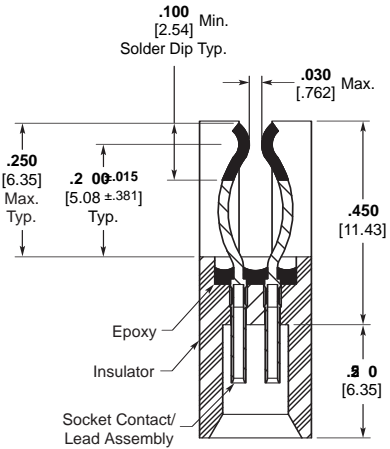
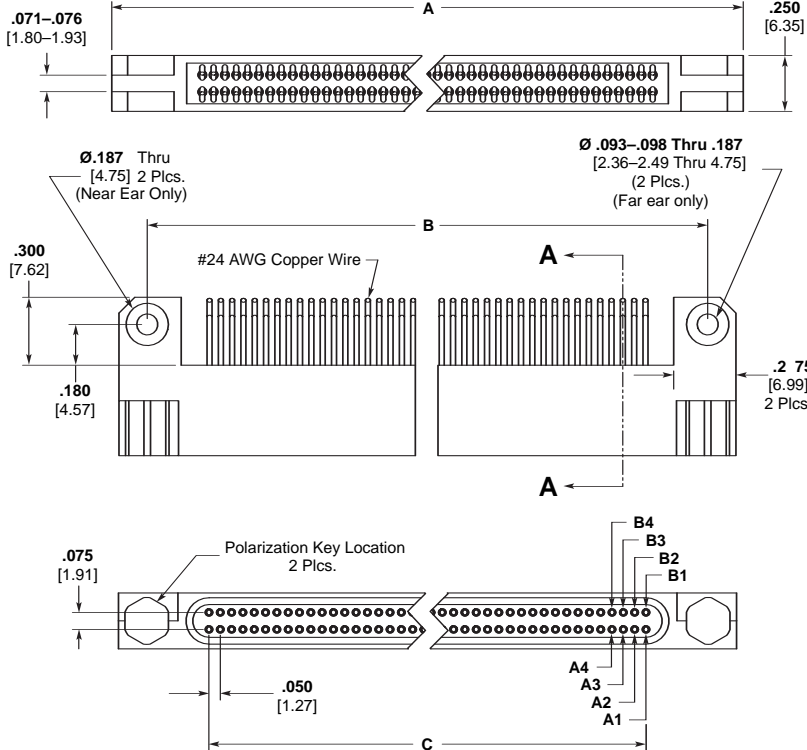

Section A-A

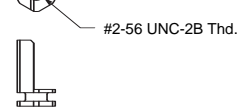

Hex Polarizing Key
2 Supplied (Loose Packed)

MCE Series Plastic Shell Edgeboard Connectors (Continued)

Dimensions for .062 [1.57] PC Board

No. of Contacts	A ± .010 [± .254]	B ± .005 [± .127]	C Basic
40	1.750 44.45	1.500 38.10	.950 24.13
44	1.850 46.99	1.600 40.64	1.050 26.67
80	2.750 69.85	2.500 63.50	1.950 49.53
110	3.500 88.90	3.250 82.55	2.700 68.58

Notes: For PC Boards of different widths, consult Tyco Electronics.

How To Specify

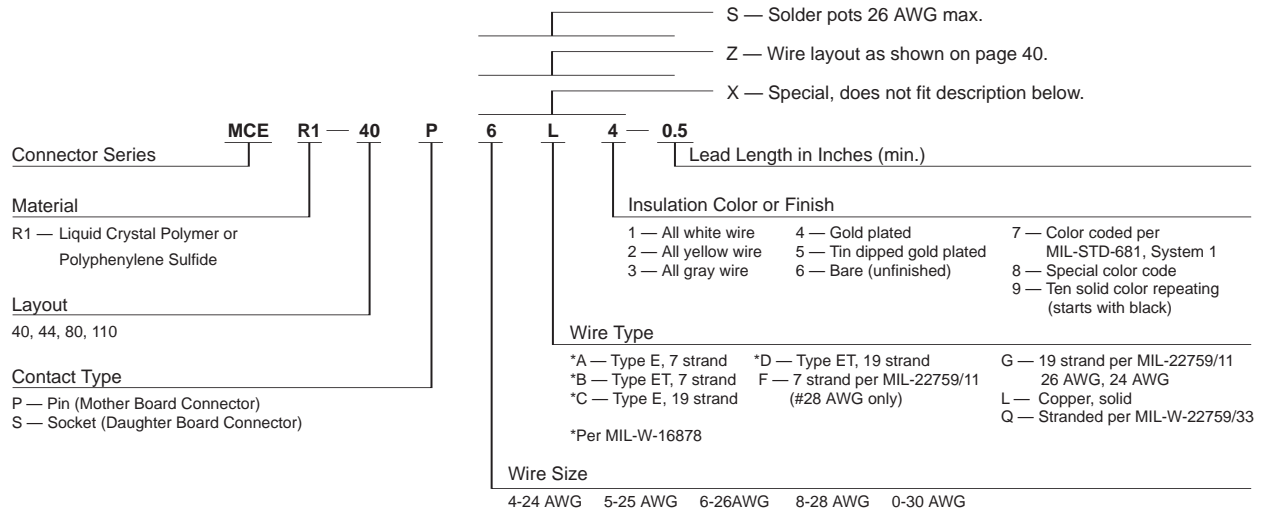

Mounting — Holes on the Daughter Board side can be modified.

Electronics

MCEM Series Metal Shell Edgeboard Connectors

Metal Shell Edge Board Connectors

- Meets MIL-DTL-55302 performance requirements
- Layouts 128 and 184 are QPL to slash sheets 120, 121, 122 and 123
- Connectors are available in 40, 44, 80, 110, 128, 152, and 184 positions
- Utilizes low force twist pins and our low force sockets. Mating forces in the 3 to 4 oz. [.83 to 1.11N] range per contact are typical with low force pin and low force socket
- Designed for surface mounting and through-the-board mounting
- Available termination
 - Mother board (pin side) — cactus bend
 - Daughter board (socket side) — coke bottle, right-angle bend to "A" or "B" side
 - Solder pots, and variety of other wire terminations for pin and socket connectors available at customer's request
- Two hexagonal polarizing keys (per MIL-DTL-55302 slash sheet 124) are provided. Jackscrew hardware is available. For programmable keying/jacking modifications consult Tyco Electronics

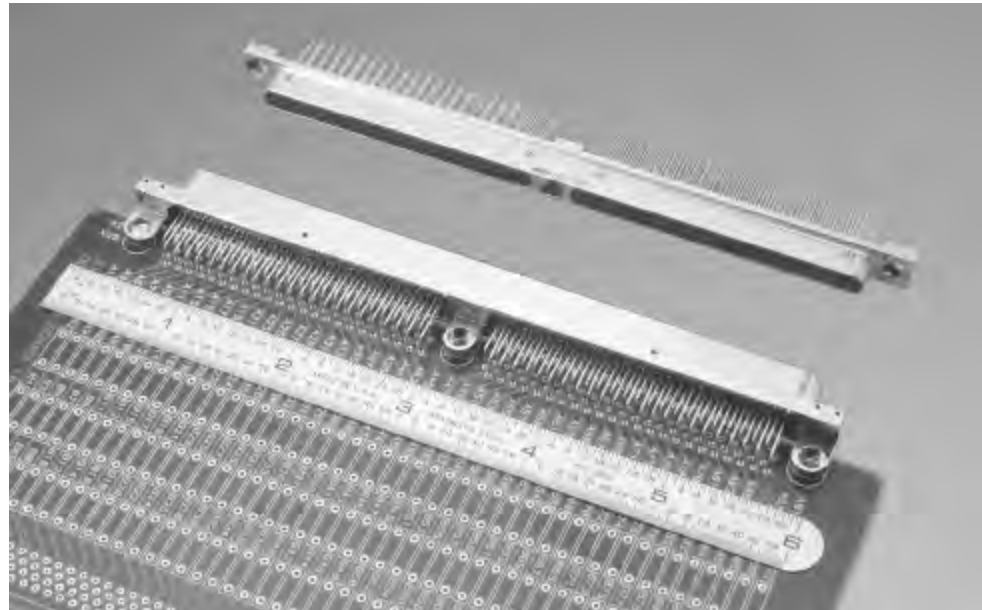

In addition to the plastic versions of the 2 piece edgeboard connectors, a metal shell assembly is designed and tooled. The metal shells are made of aluminum alloy per QQ-A-591. The insert material is Diallyl phthalate, Polyphenylene sulfide (Ryton) or Liquid Crystal Polymer (LCP). The techni-

cal and performance data is essentially the same as that shown for the MCDM Series on page 25. These are rugged, durable connectors and are ideal for use in areas of high density packaging and where frequent connect and disconnects are required. Designed initially for applications in airborne data recorders,

computers and associated equipment in navigational systems. The mother board connector can be ordered to fit any pattern on the circuit board. The units can also be provided with contacts on .100 [2.54] spacing which results in .100 [2.54] grid pattern.

Performance Data

Electrical

Contact Resistance — The average mated contact resistance is 4 milliohms, with a maximum value of 8 milliohms. The average resistance value at 100 microvolts is 4.8 milliohms.

Dielectric Withstanding Voltage — 800 VAC RMS at sea level (600 for solder pots); 200 VAC RMS at 70,000 feet [21,336m] (150 for solder pots).

Durability — Less than the maximum allowable, 8 milliohms after 500 mating cycles.

Insulation Resistance — Greater than 5,000 megohms at room ambient temperature.

Maximum Current Carrying

Capacity — No. 24 contact 3 amperes.

Mechanical

Contact Engaging & Separation

Forces — 5.0 oz. max. [1.39N] (eng.), 0.5 oz. min. [.14N] (sep.).

Environmental

Temperature Range — -67°F to 302°F [-55° C to +150° C] for Diallyl Phthalate; -67°F to 257°F [-55° C to +125° C] for Polyphenylene Sulfide.

Vibration — No discontinuity in excess of 1 μ sec. during twelve 20 minute sweeps from 10 to 2000 CPS at .06 double amplitude or 20 G forces, whichever is less.

Materials and Finish

Shells — High grade aluminum alloy, electroless nickel plated per AMS 2404.

Insulator — Diallyl Phthalate per MIL-M-14, Type SDG-F (for 128 & 184); Polyphenylene Sulfide per MIL-M-24519 (for 40, 44, 80, 110 & 152), or Liquid Crystal Polymer per ASTM D5138.

Contacts — Pin (low force): beryllium and OFHC copper, gold plated. Socket (low force): Copper alloy, gold plated.

Hardware — Corrosion resistant stainless steel passivated.

MCEM Series Metal Shell Edgeboard Connectors (Continued)

Mother Board (Pin Side)
40, 44, 80, 110 & 128 Positions

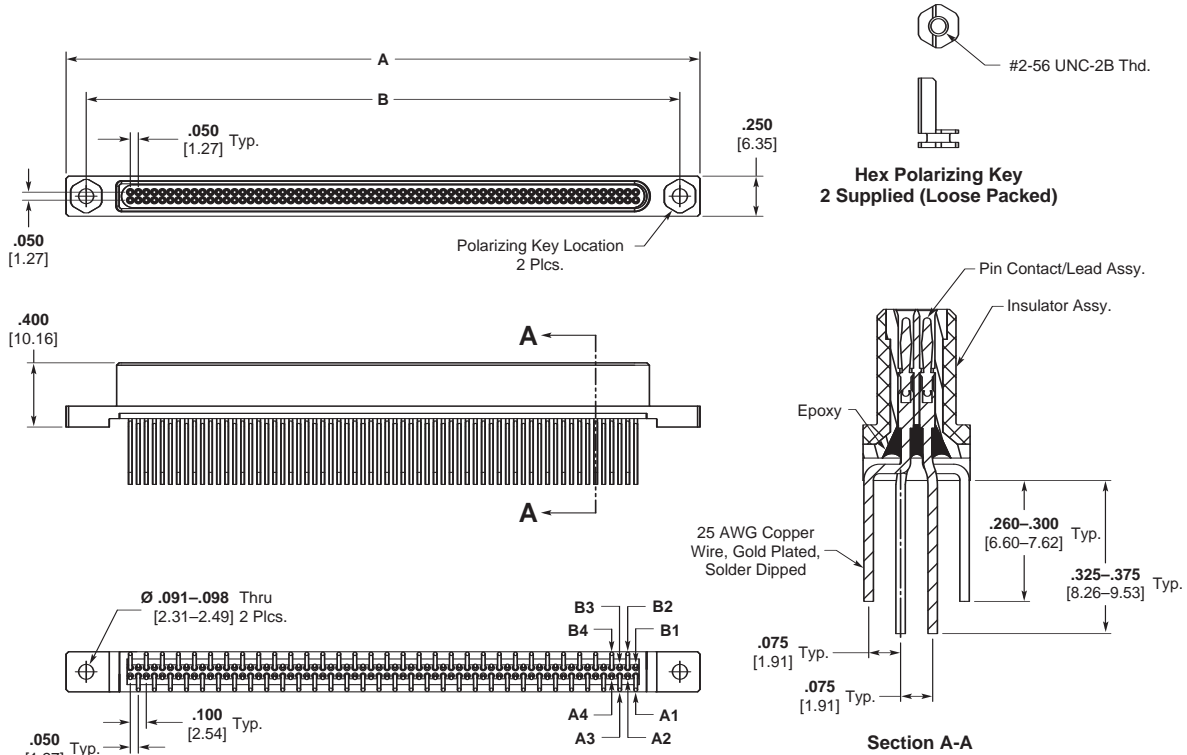
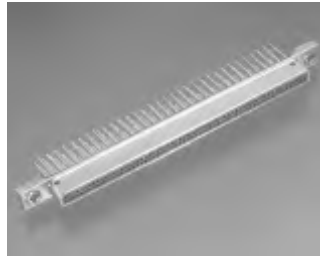

Dimensions for **.062 [1.57] PC Board**

No. of Contacts	A ± .010 [± .254]	B ± .005 [± .127]
40	1.750 44.45	1.500 38.10
44	1.850 46.99	1.600 40.64
80	2.750 69.85	2.500 63.50
110	3.500 88.90	3.250 82.55
128	3.950 100.33	3.700 93.98

Note: For PC Boards of different widths, consult Tyco Electronics.

Items in bold italic are qualified to MIL-DTL-55302.
Configuration shown is per MIL-DTL-55302/120.

Daughter Board
(Socket Side)
40, 44, 80, 110 & 128 Positions

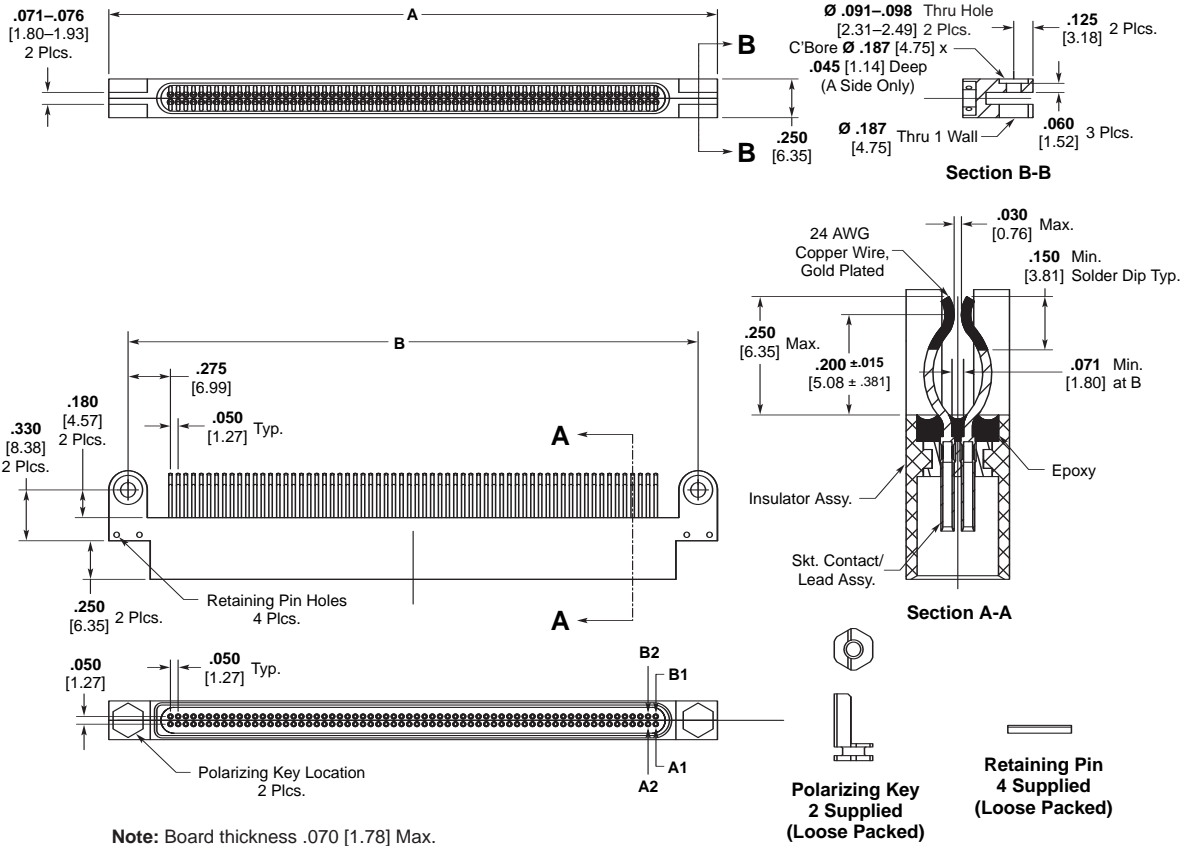
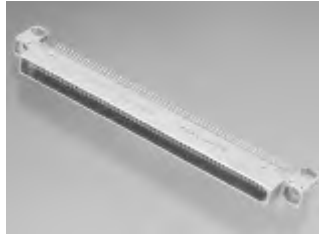

How To Specify

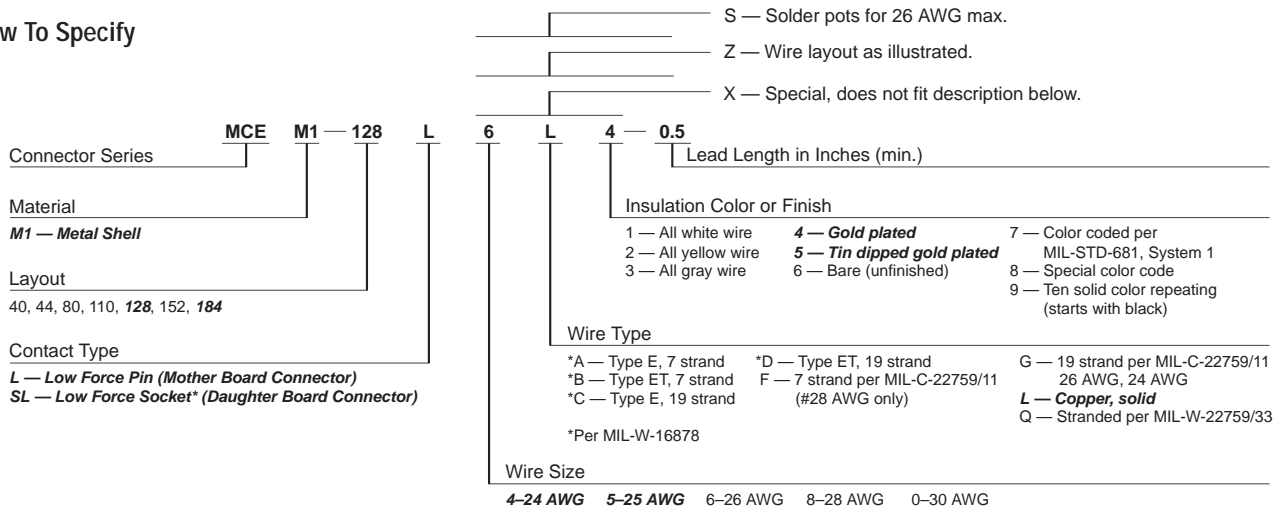

Items in bold italic are qualified to MIL-DTL-55302. Configuration shown is per MIL-DTL-55302/121.

Mother Board (Pin Side)
152 & 184 Positions

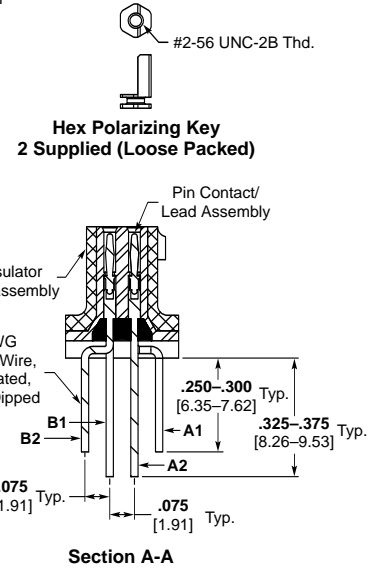
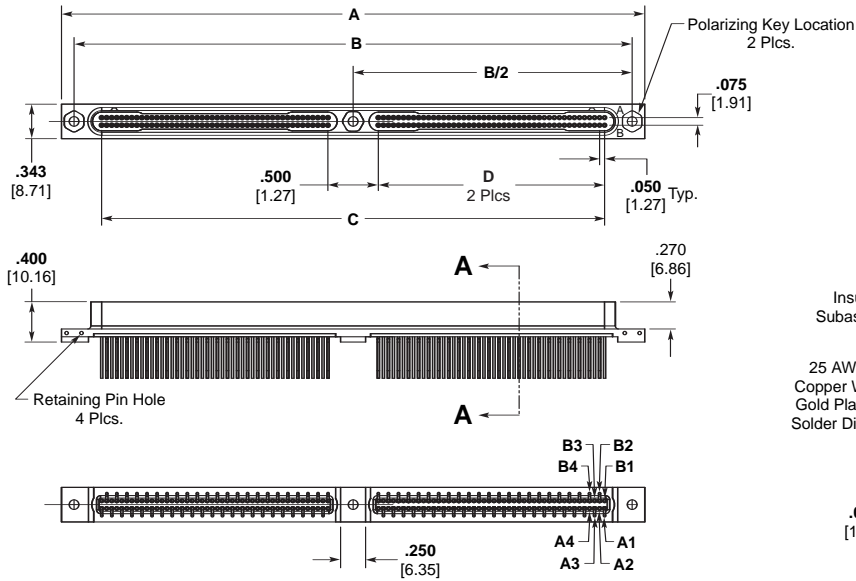

Daughter Board (Socket Side)
152 & 184 Positions

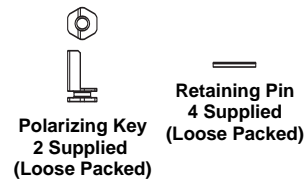
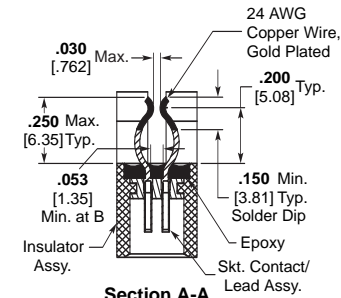
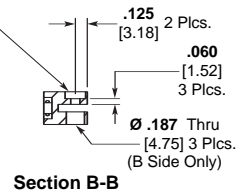
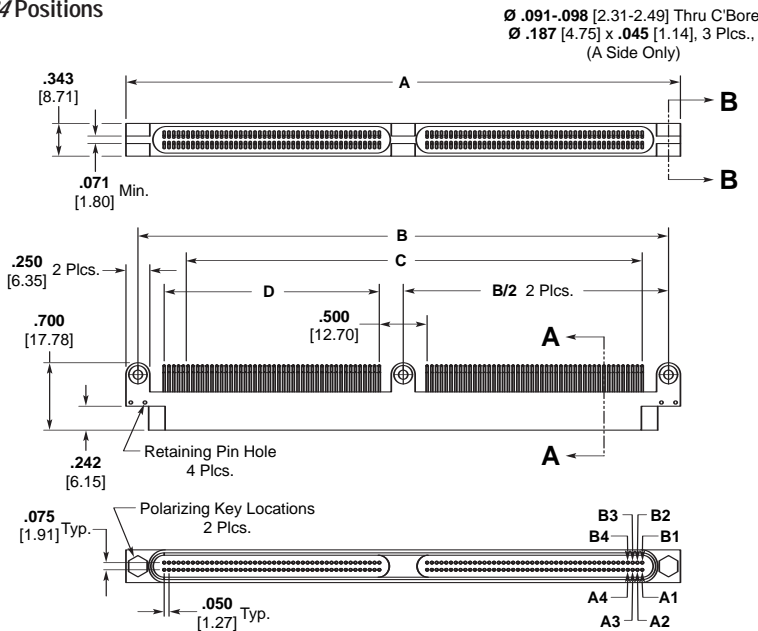

No. of Contacts	A ± .010 [± .254]	B ± .005 [± .127]	C Basic	D Basic
152	4.550 115.57	4.300 109.22	4.750 120.65	1.850 46.99
184	5.800 147.32	5.550 140.97	5.000 127.00	2.250 57.15

JACKMATE MCJ(M) Series Plastic (Metal) Shell Center Jackscrew Connectors

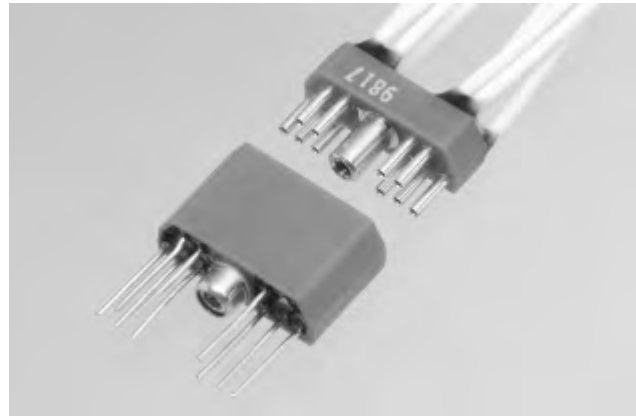

JACKMATE Connectors are the first Twist Pin contact assemblies designed to accommodate center jackscrews that provide jacking action when mating or unmating the connectors. Although the units were initially developed for high density cord-to-cord or in-line applications, either plug or receptacle can be

adapted to a PC board. The jacking hardware consist of a threaded bushing and a captivated jackscrew which are made of corrosion resistant stainless steel and are molded into the JACKMATE Connector Insulator.

The twist pin contacts are on .050 [1.27] center-to-

center linear spacing and contact terminations are available in solid wire or stranded wire. There is a high degree of flexibility with this JACKMATE connector design for commercial or military applications.

Available on MCJ(M) Series Plastic (Metal) Shells.

JACKMATE MCJ Series Plastic Shell Center Jackscrew Connectors

JACKMATE Technical & Performance Data for Plastic Shell

Electrical

Contact Resistance — The average mated contact resistance is 4 milliohms, with a maximum value of 8 milliohms, using standard 24 AWG solid copper leads when measured directly behind the crimp joints of the mated pin and socket contacts. The average resistance value at 100 microvolts is 4.8 milliohms.

Dielectric Withstanding Voltage (60 Hz rms room temperature) — Solder Pots: 600 VAC at sea level; 150 VAC at 70,000 feet [21,336m] Wire Terminations: 750 VAC at sea level; 200 VAC at 70,000 feet [21,336m].

Corrosion Resistance (Per MIL-STD-202C, Method 101B, Condition B) — Both mated and unmated samples do not

exceed the maximum allowable contact resistance (8 milliohms) when subjected to the 48 hour salt spray test.

Durability — The contact resistance after 500 mating cycles is less than the maximum allowable, 8 milliohms.

Insulation Resistance — Greater than 5,000 megohms at room temperature for the materials listed under "Materials".

Maximum Current Carrying Capacity — No. 24 contact 3 amperes. It must be recognized, however, that all the wires to a connector will not carry their maximum current under all environmental conditions due to wire temperature.

Mechanical

Contact Engaging & Separation Forces — 8.0 oz. max. [2.22N] (eng.), 0.5 oz. min. [1.4N] (sep.).

Environmental

Temperature Range (Operating) — -67°F to 257°F [-55° C to 125° C].

Vibration (Per MIL-STD-202C, Method 204-A, Condition D) — No discontinuity in excess of 1 μ sec. during twelve 20 minute sweeps from 10 to 2000 CPS at .06 double amplitude or 20 G forces, whichever is less.

Materials

Insulator — Glass filled Nylon Type 6.

Contacts — Pin contact: copper alloy and beryllium copper alloy make up the complete construction; Socket contact: copper alloy.

Hardware — Corrosive resistant stainless steel.

Finishes

Contacts — Standard finish is 0.000050 [0.00127] gold over copper flash per MIL-G-45204, Type II.

Hardware — Passivated Per QQ-P-35.

10 & 14 Contact Layout

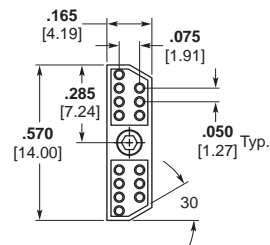

14 Layout

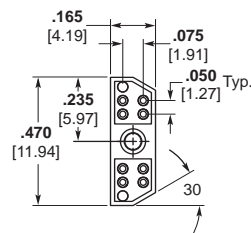

10 Layout

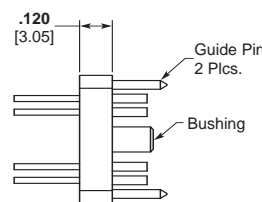

Receptacle

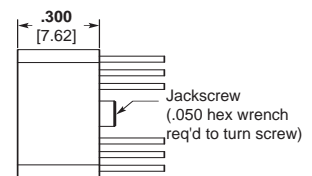

Plug

26, 38 & 46 Contact Layout

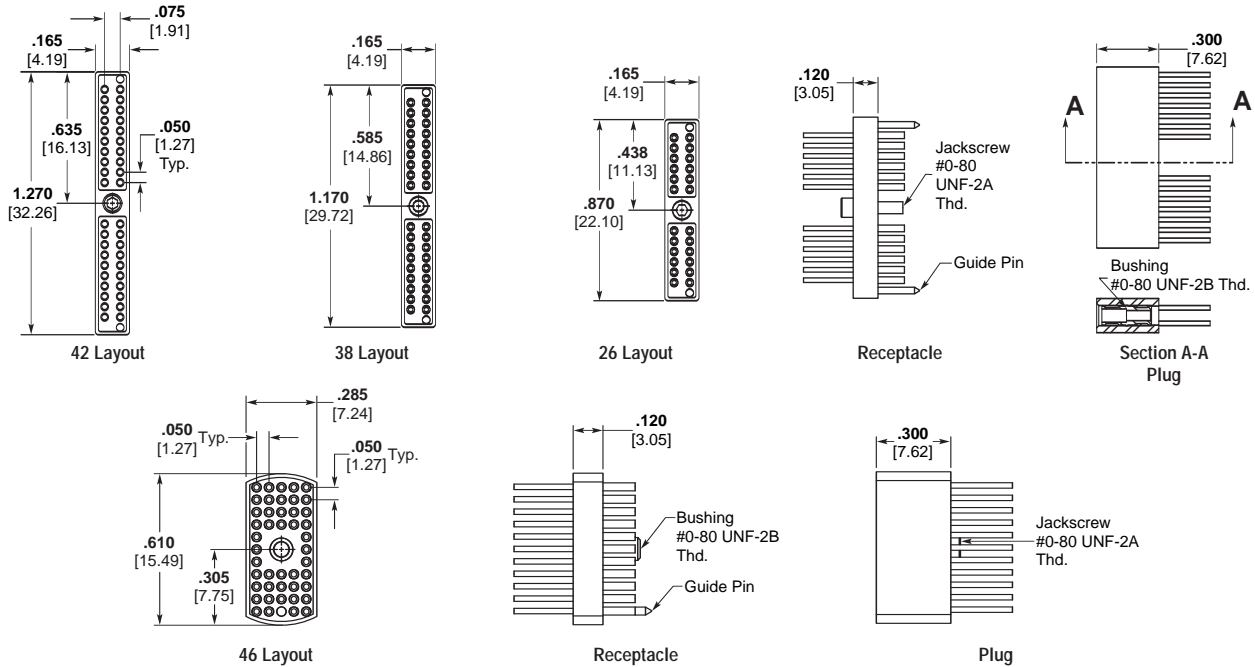

How To Specify

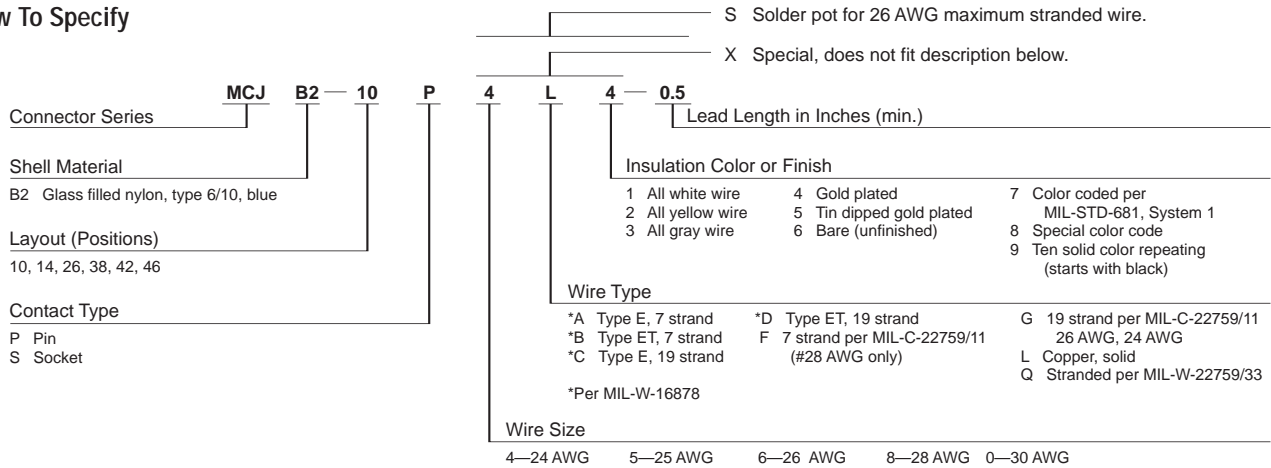

Contact Arrangement as Viewed from the Engaging Face of the Pin Side

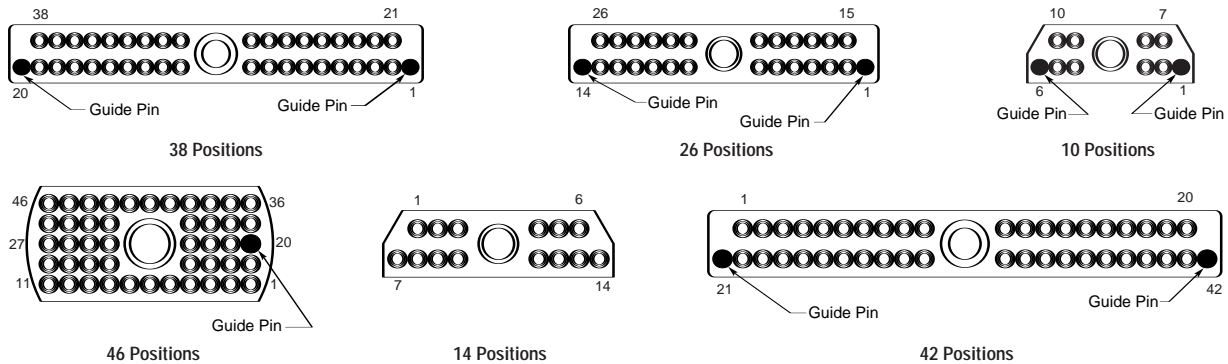

Guide pin locations illustrated are for standards configuration only. Any location is available. Guide pins are supplied in socket connectors and blank cavities are in pin connector.

JACKMATE MCJM Series Metal Shell Center Jackscrew Connectors

Technical and Performance Data for Metal Shell

Electrical

Contact Resistance — The average mated contact resistance is 4 milliohms, with a maximum value of 8 milliohms, using standard 24 AWG solid copper leads when measured directly behind the crimp joints of the mated pin and socket contacts. The average resistance value at 100 microvolts is 4.8 milliohms.

Dielectric Withstanding Voltage (60 Hz rms room temperature) — Solder Pots: 600 VAC at sea level; 150 VAC at 70,000 feet [21,336m].

Wire Terminations: 750 VAC at sea level; 200 VAC at 70,000 feet [21,336m].

Corrosion Resistance (Per MIL-STD-202C, Method 101B, Condition B) — Both mated and unmated samples do not exceed the maximum allowable contact resistance (8 milliohms) when subjected to the 48 hour salt spray test.

Durability — The contact resistance after 500 mating cycles is less than the maximum allowable, 8 milliohms.

Insulation Resistance — Greater than 5,000 megohms at room temperature for the materials listed under "Materials".

Maximum Current Carrying Capacity — No. 24 contact 3 amperes. It must be recognized, however, that all the wires to a connector will not carry their maximum current under all environmental conditions due to wire temperature.

Mechanical

Contact Engaging & Separation Forces — 8.0 oz. max. [2.22N] (eng.), 0.5 oz. min. [.14N] (sep.).

Environmental

Temperature Range (Operating) — -67°F to 302°F [-55°C to 150°C] for Diallyl Phthalate.

Vibration (Per MIL-STD-202C, Method 204-A, Condition D) — No discontinuity in excess of 1 μ sec. during twelve 20 minute sweeps from 10 to 2000 CPS at .06 double amplitude or 20 G forces, whichever is less.

Materials

Insulator — Diallyl Phthalate per MIL-M-14, Type SDG-F.

Contacts — Pin contact: copper alloy and beryllium copper alloy make up the complete construction; Socket contact: copper alloy.

Body Shells — Pin body shell: stainless steel, Types 304, Condition A per QQ-S-766; Socket body shell: aluminum alloy per QQ-A-591, A-380 alloy.

Hardware — Corrosion resistant stainless steel.

Finishes

Contacts — Standard finish is 0.000050 [0.00127] gold over copper flash per MIL-G-45204, Type II.

Body Shells — Pin body shell: passivated per MIL-F-14072 (E-300); Socket body shell: electroless nickel per AMS 204, Class 3, except thickness is 0.001/0.0015 [0.025/0.038].

Hardware — Passivated per QQ-P-35.

Note: Insulators are molded into their metal shells — No bonded joint is used.

*Standard material used unless otherwise specified.

**Plug (Pin Side)
Shell Type M1**

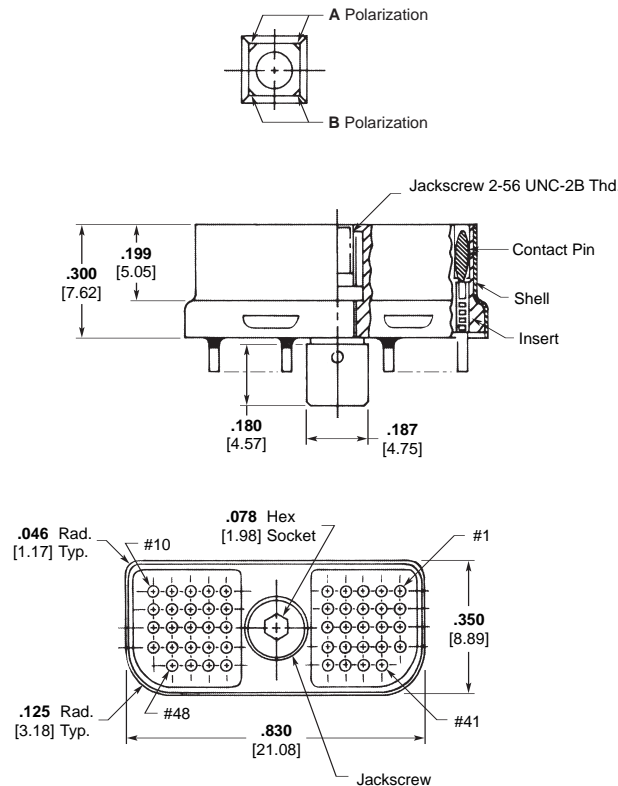

Receptacle (Socket Side)

Shell Type M1

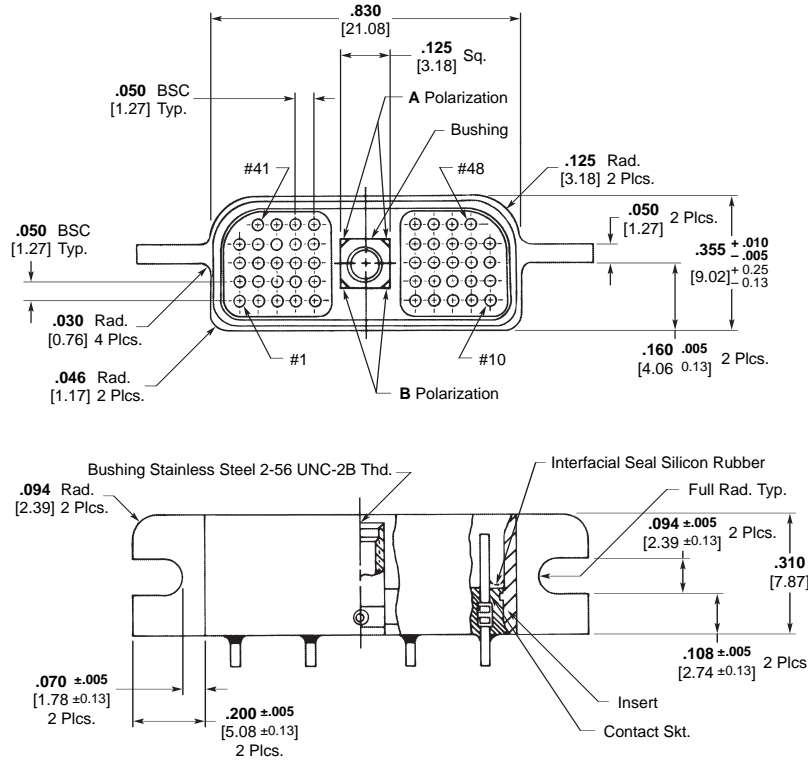

Shell Type M2

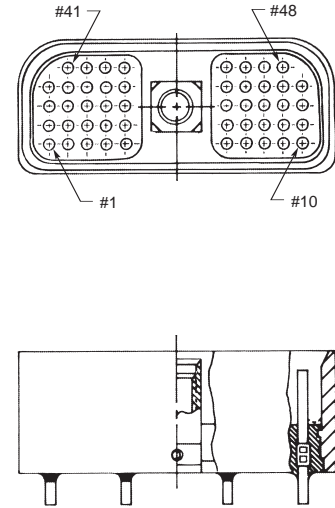

How To Specify

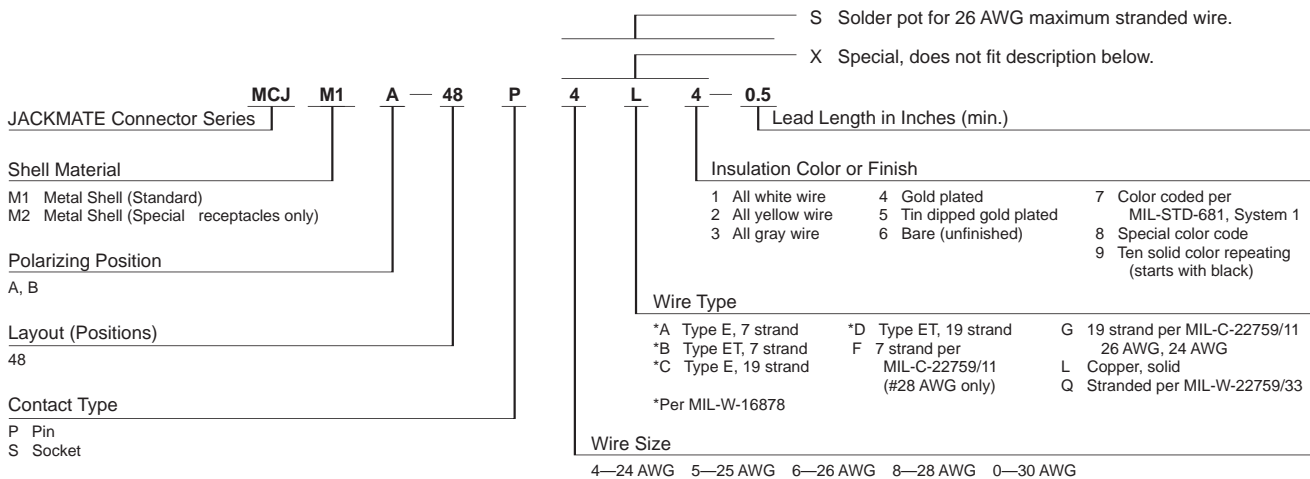

MCS Series Strip Connectors

Strip Connectors

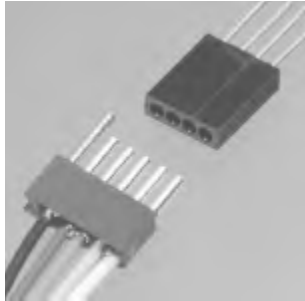

MCS Plastic Strip

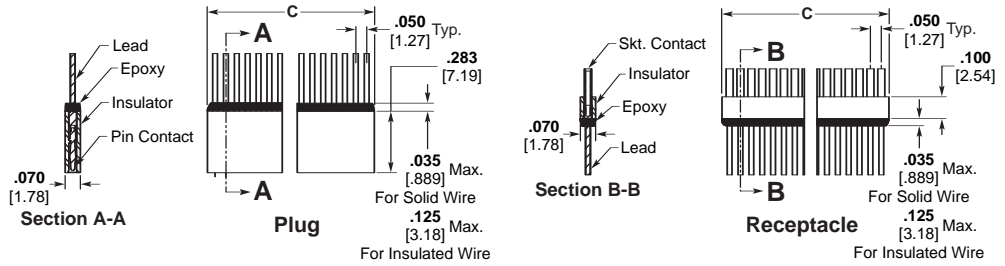

Part No.	By Size	C Max.
MCSAR*-1**	.070	[1.78]
MCSAR*-2**	.120	[3.05]
MCSAR*-3**	.170	[4.32]
MCSAR*-4**	.220	[5.59]
MCSAR*-5**	.270	[6.86]
MCSAR*-6**	.320	[8.13]
MCSAR*-7**	.420	[10.67]
MCSAR*-8**	.420	[10.67]
MCSAR*-9**	.470	[11.94]
MCSAR*-10**	.520	[13.21]
MCSAR*-11**	.570	[14.48]
MCSAR*-12**	.620	[15.75]
MCSAR*-13**	.670	[17.02]
MCSAR*-14**	.720	[18.29]
MCSAR*-15**	.770	[19.56]
MCSAR*-16**	.820	[20.83]
MCSAR*-17**	.870	[22.10]
MCSAR*-18**	.920	[23.37]
MCSAR*-19**	.970	[24.64]
MCSAR*-20**	1.020	[25.91]
MCSAR*-21**	1.070	[27.18]
MCSAR*-22**	1.120	[28.45]
MCSAR*-23**	1.170	[29.72]
MCSAR*-24**	1.220	[30.99]
MCSAR*-25**	1.270	[32.26]
MCSAR*-26**	1.320	[33.53]
MCSAR*-27**	1.370	[34.80]
MCSAR*-28**	1.420	[36.07]
MCSAR*-29**	1.470	[37.34]
MCSAR*-30**	1.520	[38.61]

Part No.	By Size	C Max.
MCSAR*-31**	1.570	[39.88]
MCSAR*-32**	1.620	[41.15]
MCSAR*-33**	1.670	[42.42]
MCSAR*-34**	1.720	[43.69]
MCSAR*-35**	1.770	[44.96]
MCSAR*-36**	1.820	[46.23]
MCSAR*-37**	1.870	[47.50]
MCSAR*-38**	1.920	[48.77]
MCSAR*-39**	1.970	[50.04]
MCSAR*-40**	2.020	[51.31]
MCSAR*-41**	2.070	[52.58]
MCSAR*-42**	2.120	[53.85]
MCSAR*-43**	2.170	[55.12]
MCSAR*-44**	2.220	[56.39]
MCSAR*-45**	2.270	[57.66]
MCSAR*-46**	2.320	[58.93]
MCSAR*-47**	2.370	[60.20]
MCSAR*-48**	2.420	[61.47]
MCSAR*-49**	2.470	[62.74]
MCSAR*-50**	2.520	[64.01]
MCSAR*-51**	2.570	[65.28]
MCSAR*-52**	2.620	[66.55]
MCSAR*-53**	2.670	[67.82]
MCSAR*-54**	2.720	[69.09]
MCSAR*-55**	2.770	[70.36]
MCSAR*-56**	2.820	[71.63]
MCSAR*-57**	2.870	[72.90]
MCSAR*-58**	2.920	[74.17]
MCSAR*-59**	2.970	[75.44]
MCSAR*-60**	3.020	[76.71]

Part No.	By Size	C Max.
MCSAR*-61**	3.070	[77.98]
MCSAR*-62**	3.120	[79.25]
MCSAR*-63**	3.170	[80.52]
MCSAR*-64**	3.220	[81.79]
MCSAR*-65**	3.270	[83.06]
MCSAR*-66**	3.320	[84.33]
MCSAR*-67**	3.370	[85.60]
MCSAR*-68**	3.420	[86.87]
MCSAR*-69**	3.470	[88.14]
MCSAR*-70**	3.520	[89.41]
MCSAR*-71**	3.570	[90.68]
MCSAR*-72**	3.620	[91.95]
MCSAR*-73**	3.670	[93.22]
MCSAR*-74**	3.720	[94.49]
MCSAR*-75**	3.770	[95.76]
MCSAR*-76**	3.820	[97.03]
MCSAR*-77**	3.870	[98.30]
MCSAR*-78**	3.920	[99.57]
MCSAR*-79**	3.970	[100.84]
MCSAR*-80**	4.020	[102.11]
MCSAR*-81**	4.070	[103.38]
MCSAR*-82**	4.120	[104.65]
MCSAR*-83**	4.170	[105.92]
MCSAR*-84**	4.220	[107.19]
MCSAR*-85**	4.270	[108.46]
MCSAR*-86**	4.320	[109.73]
MCSAR*-87**	4.370	[111.00]
MCSAR*-88**	4.420	[112.27]
MCSAR*-89**	4.470	[113.54]
MCSAR*-90**	4.520	[114.81]

Part No.	By Size	C Max.
MCSAR*-91**	4.570	[116.08]
MCSAR*-92**	4.620	[117.35]
MCSAR*-93**	4.670	[118.62]
MCSAR*-94**	4.720	[119.89]
MCSAR*-95**	4.770	[121.16]
MCSAR*-96**	4.820	[122.43]
MCSAR*-97**	4.870	[123.70]
MCSAR*-98**	4.920	[124.97]
MCSAR*-99**	4.970	[126.24]
MCSAR*-100**	5.020	[127.51]
MCSAR*-101**	5.070	[128.78]
MCSAR*-102**	5.120	[130.05]
MCSAR*-103**	5.170	[131.32]
MCSAR*-104**	5.220	[132.59]
MCSAR*-105**	5.270	[133.86]
MCSAR*-106**	5.320	[135.13]
MCSAR*-107**	5.370	[136.40]
MCSAR*-108**	5.420	[137.67]
MCSAR*-109**	5.470	[138.94]
MCSAR*-110**	5.520	[140.21]
MCSAR*-111**	5.570	[141.48]
MCSAR*-112**	5.620	[142.75]
MCSAR*-113**	5.670	[144.02]
MCSAR*-114**	5.720	[145.29]
MCSAR*-115**	5.770	[146.56]
MCSAR*-116**	5.820	[147.83]
MCSAR*-117**	5.870	[149.10]
MCSAR*-118**	5.920	[150.37]
MCSAR*-119**	5.970	[151.64]
MCSAR*-120**	6.020	[152.91]

How To Specify

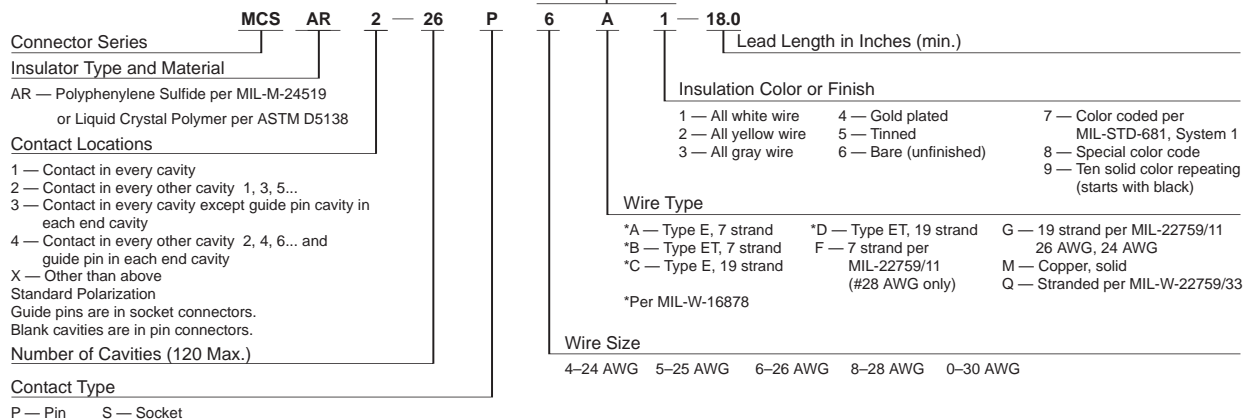

High Density Standard Module (HDSM) Connectors

Features

- Designed for surface mounting on both daughter board and mother board for increased circuit density
- Basic design offers 38, 78, 120, 152, 200, 304, and 400 contact designs
- High reliability twist pin and socket per MIL-DTL-83513 and MIL-DTL-55302
- Connector permits lateral movement of daughter board to accommodate clamping of the heatsink
- Plated through-hole mounting available
- Available with flying leads
- Extender card option available
- Typical mating force for 304 contacts is 38 pounds
- Designed to withstand vapor phase soldering
- Two rotatable (six position) polarizing keys are provided accommodating 36 possible combinations
- Jackscrew hardware available; consult Tyco Electronics
- Different modular inserts may be specified to include coax (Pixi/Con), fiber optic or other special contacts
- Inserts may be partially or fully loaded and installed in the connector shell in various configurations

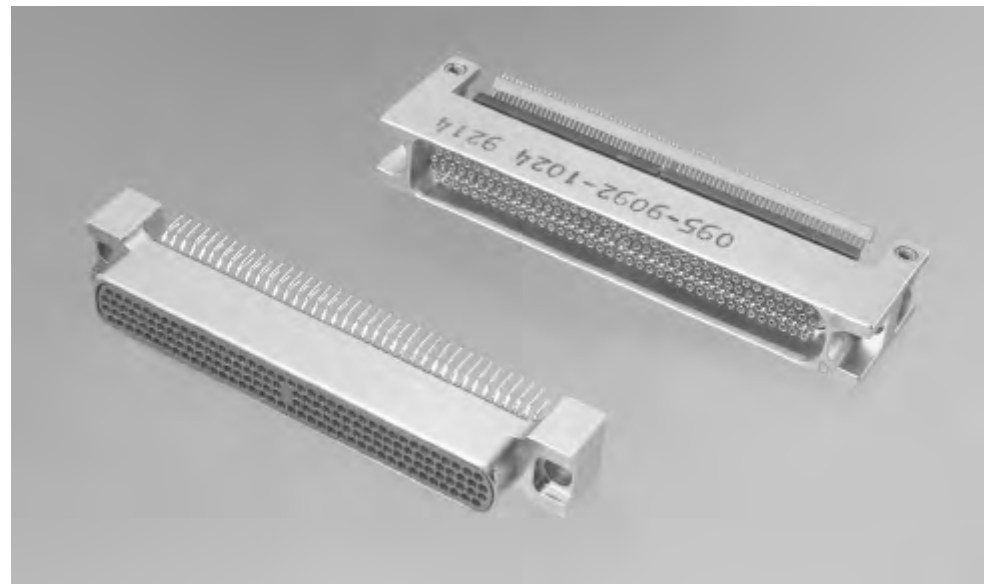

The MICRODOT HDSM connector is designed for 4 row .050 [1.27] pitch density with a special low force twist pin that meets all requirements of MIL-DTL-55302 and MIL-DTL-83513. This high density connector allows the use of construction to double the packaging density with surface mount capability.

Performance Data Summary

Electrical

Contacts — Pin 24 AWG twist pin, Socket #24 AWG, Wire range 24 AWG to 32 AWG solid and stranded.

Contact Resistance (voltage drop) — 25 millivolts max. at 3 amps, 25° ± 3° C.

Current Rating — 3 amps max. per contact

Dielectric Withstanding Voltage — Volts RMS 60 Hz at room ambient: 600 V for solder pots at sea level. 150 V for solder pots at 70,000 ft. [21,336m] 500 V for wire terminations at sea level. 200 V for wire terminations at 70,000 ft.

Insulation Resistance — 5,000 megohms min. at room ambient.

Magnetic Permeability — 2 μm max.

Mechanical

Contact Spacing — .050 [1.27] centers

Contact Engagement & Separation — 5.0 oz max. [1.39N] (eng.) 0.5 oz. min. [.14N] 3.5 oz. typ. [.97N] (sep.) force.

Materials and Finishes

Contacts — Copper alloy plated with .000050 [0.00127] gold over copper flash per MIL-G-45204, Type II.

Metal Shell — Insulator — Liquid Crystal Polymer (LCP) per ASTM D5138 or Polyphenylene Sulfide per MIL-M-24519 Body Shell — Aluminum alloy plated Nickel, electroless per MIL-C-26074.

Environmental

Temperature Range — -67°F to 257°F [-55° C to +125° C].

Vibration — No discontinuity in excess of 1 micro sec. when tested in accordance with MIL-STD-1344, Method 2005, test Condition IV.

Insulator Retention — Inserts will withstand a 50 lb. per square inch load in either direction.

Shock — No discontinuity in excess of 1 micro sec. when tested in accordance with MIL-STD-1344, Method 2004, test Condition E.

Durability — No mechanical or electrical defects detrimental to the function of the connectors after 500 cycles of mating and unmating. (Caution: Mating force increases during durability cycling may be noted).

Humidity — After exposure to humidity as specified by MIL-STD-1344, Method 1002, Type II, IR shall be 1 megohm min. immediately following step 7a of Method 1002 and 1000 megohms min. after 24 hours of conditioning per Method 1002.

Salt Spray — Connectors shall meet the performance requirements of contact resistance, mating and unmating forces, and contact retention after being subjected to the 48-hour 5% solution salt spray test per MIL-STD-1344, Method 1001, Condition B.

Crimp Termination Tensile Strength — *Unassembled contacts with crimped stranded wire terminations. Wires will not pull out of contacts when the following axial loads are applied: 24 AWG, 5 lbs., 26 AWG, 4 lbs., 28 AWG, 3 lbs.

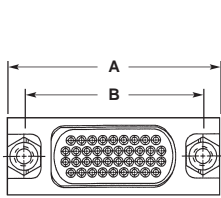

38 & 78 Position Plug

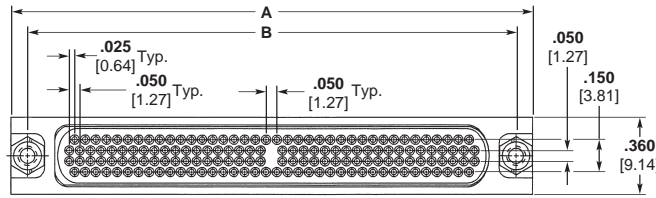

120, 152 & 200 Position Plug

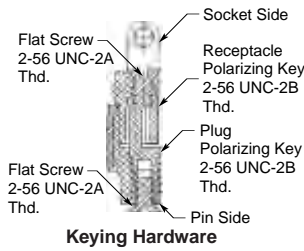

Keying Hardware

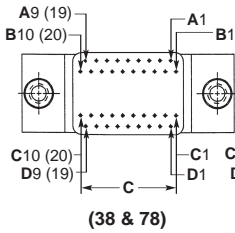
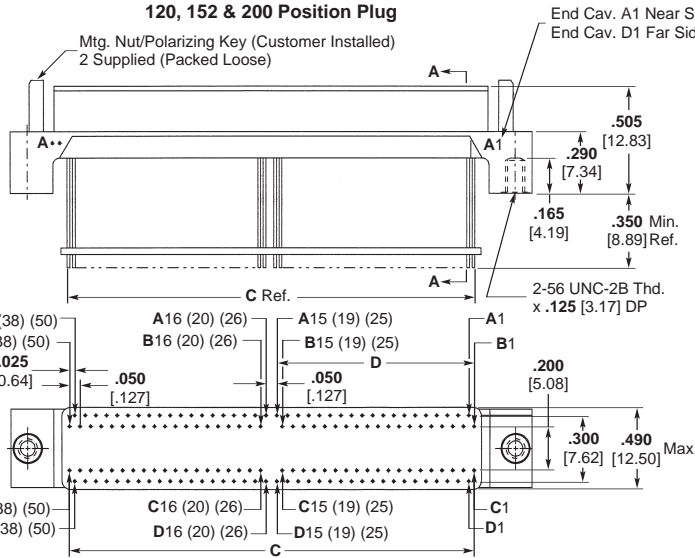

(38 & 78)

(120, 152 & 200)

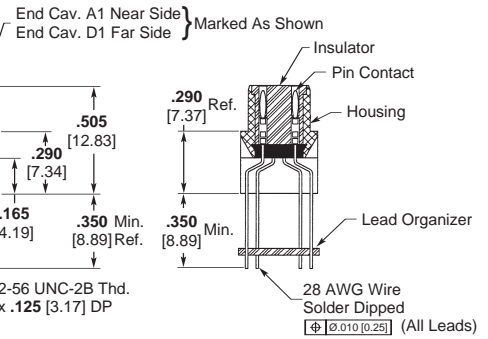

Section A-A

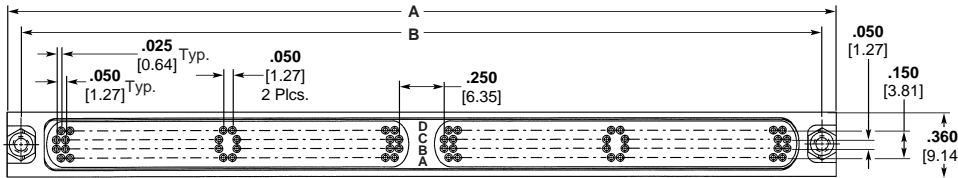

304 & 400 Position Plug

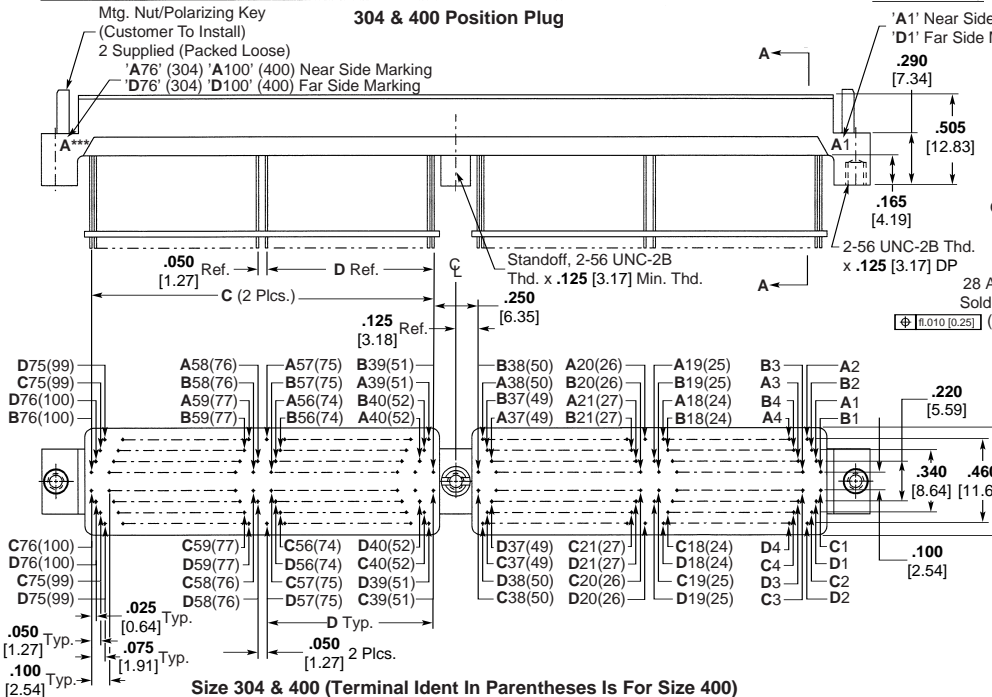

Size 304 & 400 (Terminal Ident In Parentheses Is For Size 400)

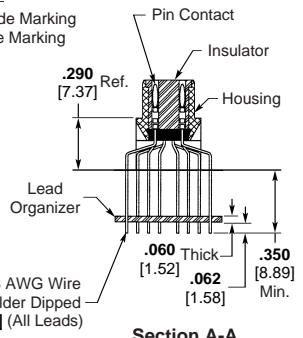

Section A-A

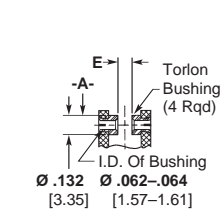
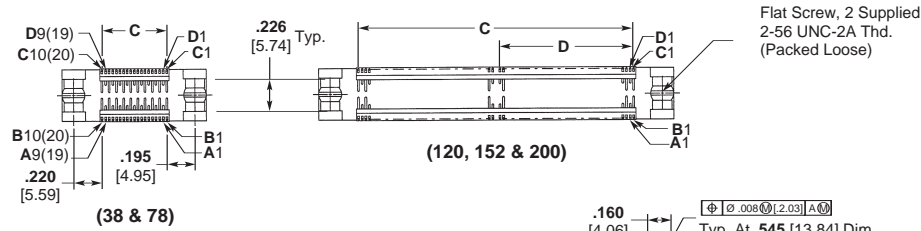

Section B-B

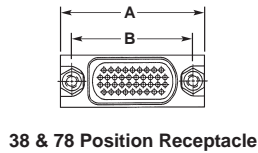
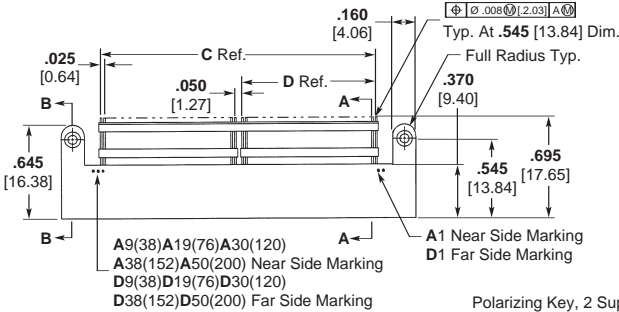

38 & 78 Position Receptacle

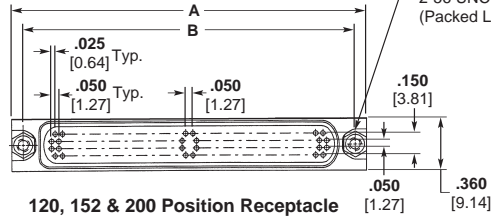

120, 152 & 200 Position Receptacle

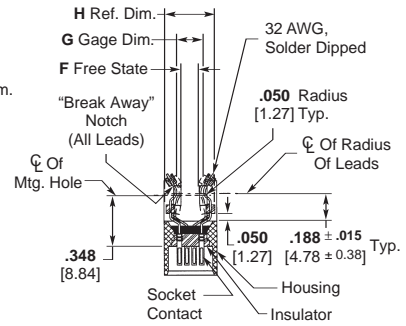

Section A-A

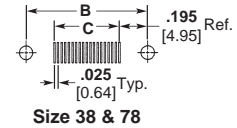

Size 38 & 78

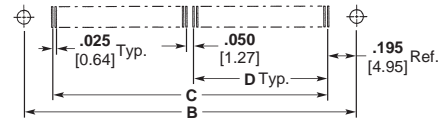

Size 120, 152 & 200
Recommended PCB Footprint Pattern

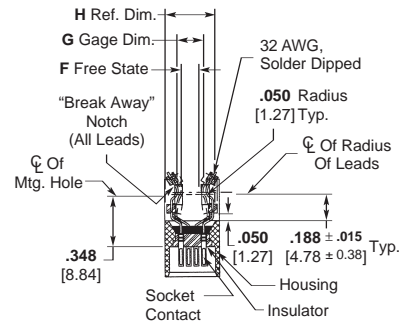
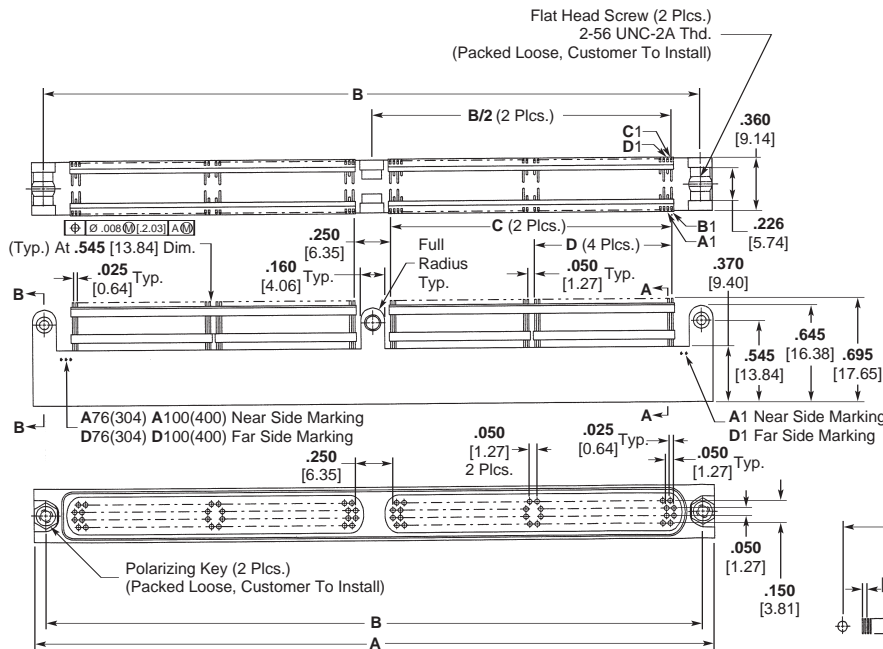

Section A-A

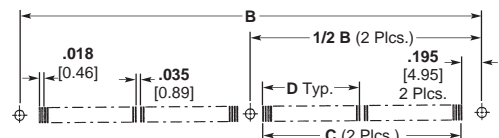

Size 304 & 400
Recommended PCB Footprint Pattern

High Density Standard Module (HDSM) Connectors (Continued)

No. of Cavities	A Dim.	B Dim.	C Dim.	D Dim.
Single Bay				
38	1.000 25.40	.840 21.34	.450 11.43	—
78	1.500 38.10	1.340 34.04	.950 24.13	—
120	2.050 52.07	1.890 48.01	1.500 38.10	.725 18.42
152	2.450 62.23	2.290 58.17	1.900 48.26	.925 23.50
200	3.050 77.47	2.890 73.41	2.500 63.50	1.225 31.12
Double Bay				
304	4.600 116.84	4.440 112.78	1.900 48.26	.925 23.50
400	5.800 147.32	5.640 143.26	2.500 63.50	1.225 31.12

How To Specify

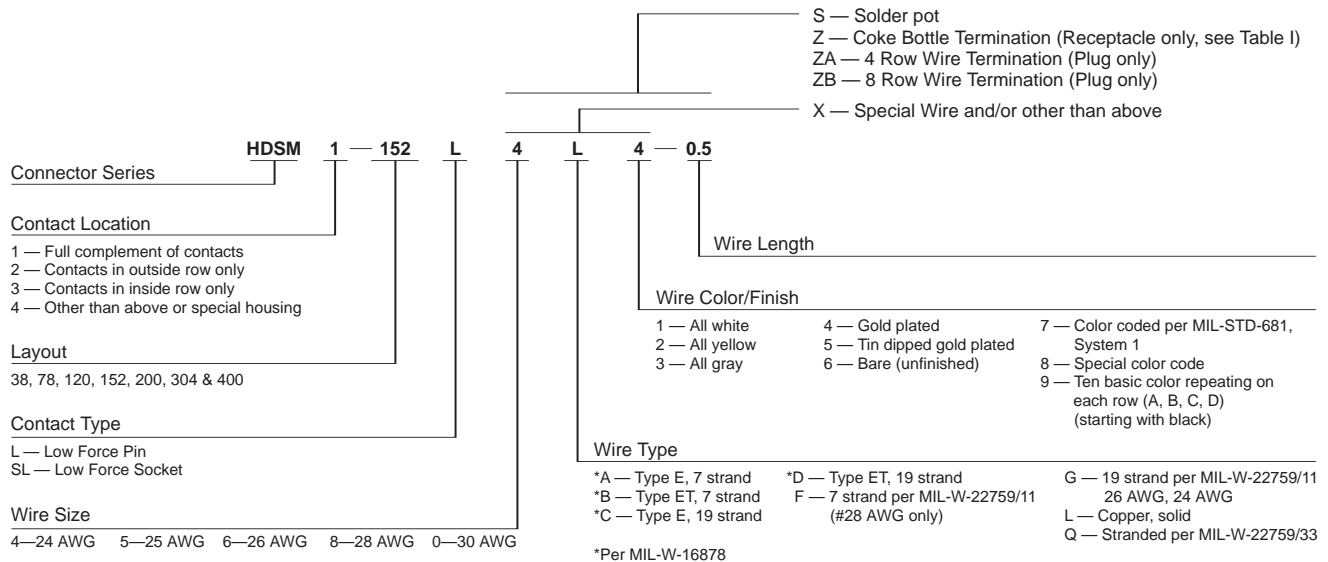

Table I

Dash No.	Gap Between Bushing "E"	F Dim.	G Dim.	H Dim. (Ref.)
1	.100 2.54	.120 3.05	.180 4.57	.330 8.38
2	.093 2.36	.060 1.52	.150 3.81	.330 8.38
3	.118 2.99	.235 5.97	.260 6.60	.483 12.27
4	.145 3.68	.120 3.05	.180 4.57	.330 8.38

Introduction

High Density Circular Connectors

Product Facts

- High density, light-weight Multi-Pin Circular Connectors feature a crimp contact retention method, requiring no insertion or removal tools
- Reverse gender available
- Ideal for harsh environment
- Sealed — Silicon rubber grommet/o-ring
- Unsealed — No grommet/o-ring
- Meets MIL Standards (high quality) but is not QPL qualified
- Ideally suited to applications where many conductors must be accommodated in a minimum of space with minimum weight
- MARC Series Connectors are non-magnetic
- Contact rating 2.5A



Our high density, light-weight Multi-Pin Circular Connectors are the industry's most advanced and are ideally suited to applications where many conductors must be accommodated in a minimum of space with minimum weight.

All series of connectors feature a crimp contact retention method, requiring no insertion or removal tools.

The MARC 43 Series Connectors conform to applicable performance requirements of MIL-C-26482 and has seen extensive service on many leading aerospace and ground support equipment programs.

The MARC 53 Series Connectors, designed to conform to the USAF high reliability specification MIL-C-38300, as offers high density connector performance. The positive lock coupling mechanism, combined with our exclusive floating interfacial seal, offers outstanding performance under rigorous service conditions.

The MARC 63 Series Connectors, our Bayonet Coupling Series, accommodates all insert patterns and layouts available in the MARC 43 Series Connectors, MARC 53 Series Connectors, and RMD Series Connectors. All insert assemblies are

completely interchangeable. Lighter in weight and smaller in size than any comparable connector on the market, it requires up to 50% less engagement/separation force. Conversion to bayonet coupling shell from MARC 43 Series Connectors or MARC 53 Series Connectors is done without tools by merely transferring the contacts and insert assemblies into the MARC 63 Series Connectors shell.

The newest addition to the Multi-Pin product line is the MARC 73 Series Connectors. The twist pin Circular Connector combines the lightweight, bayonet

Introduction (Continued)

coupling feature of the MARC 63 Series Connectors with the twist pin high density, center-to-center contact spacing of 0.065 [1.65] inch. The utilization of 22 AWG twist pin and socket contacts provide for 50% greater contact densities

than presently offered in the MARC 43 Series Connectors, MARC 53 Series Connectors, or MARC 63 Series Connectors.

The MQR Series is a line of circular quick disconnect connectors for rugged environmental use.

Consult Tyco Electronics for detailed information.



SHM Receptacle
MARC 43 Series Connectors &
MARC 53 Series Connectors



Mated MARC 53
Series Connectors



SHM Receptacle
MARC 43 Series Connectors &
MARC 53 Series Connectors



Mated MARC 63 Series Connectors



Mated MARC 43 Series Connectors

Electronics

MARC 43 Series Connectors

General Information

A high density (.080 [2.03] contact centers), lightweight, subminiature, cylindrical connector series featuring crimp contacts and fingertip, push-pull, quick disconnect coupling. This series conforms to the applicable performance requirements of MIL-C-26482 and is available in unsealed, environmentally sealed, and hermetic types.

A large assortment in insert arrangements — accommodating AWG 12 through 32 gauge wire and miniature coaxial cables — is available for the design engineer's choice. The contacts are

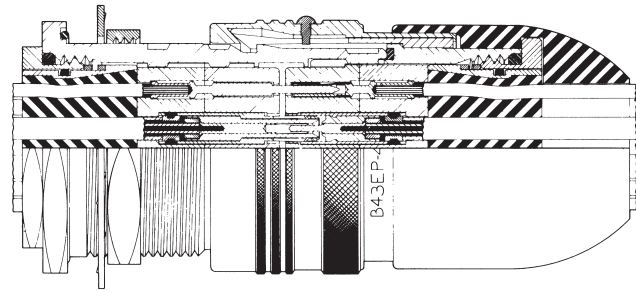

retained by shoulder entrapment and can be crimped with the standard M22520 tools, using appropriate locators. This proven series of connectors has a long history of outstanding performance

on many military and aerospace programs. MARC 43 Series Connectors are ideal for applications where high performance must be achieved at low cost.

Materials and Finishes

MARC 43 Series Connector housings and quick disconnect couplings are machined from bar stock aluminum to combine maximum strength with minimum weight. Threaded couplings are machined from non-magnetic, stainless steel bar stock for durability of the coupling threads. Contacts are manufactured from high conductivity copper alloys which have been selected for low contact resistance over the operating range of the

connectors. Inserts are molded from flame-resistant, glass-filled diallyl phthalate, meeting ASTM D5948 requirements. All resilient parts are made of high temperature, silicone rubbers. Fuel resistant compounds are used where swelling affects the performance of the connector. All materials are carefully selected for their non-magnetic properties. The standard finish is clear, non-conductive anodize on

connector housings and quick disconnect couplings. For threaded coupling applications, aluminum components are hard, black anodized, and stainless steel plug coupling is passivated with black oxide finish. Conductive finish modifications include gold, cadmium, and iridite finishes. Contacts are gold plated per MIL-G-45204 requirements. See page 63 for modification information.

Service and Performance Data

I. Electrical — Electrical Ratings

Contact Size	Current Rating Amperes, Max., +27°C ¹	Dielectric Withstanding Voltage (RMS)	Working Voltage	
			Sea Level	70,000 ft. [21,336 m] Alt.
22 AWG	5 amps	1000	750	300
16 AWG	20 amps	1000	750	300
12 AWG	50 amps	1000	750	300
50 ohm	3 amps	1000	750	300
75 ohm	3 amps	1250	1000	300
95 ohm	3 amps	1500	1250	300

¹ Consult nomograph.

II. Mechanical — Durability: 500 Cycles Mate/Unmate. Coupling/Uncoupling Forces and Tightening Torques:

Shell Size	Coupling/ Uncoupling Force (In-Lbs.) Max.	Tightening Torque (In-Lbs.)	
		Retaining Nut	Mounting Nut
A	13 [57.8 N]	20, Max. [2.26 Nm]	30-45 [3.39 Nm – 5.08 Nm]
B	17 [75.6 N]	20, Max. [2.26 Nm]	40-55 [4.52 Nm – 6.21 Nm]
C	21 [93.4 N]	20, Max. [2.26 Nm]	55-70 [6.21 Nm – 7.91 Nm]

Operating Temperature: -85°F to 257°F [-65°C to +125°C].

Contact Size	Wire Size	Conductor Dia. (Stranded) ¹	Dielectric Dia. (Teflon)	Shield Dia.	Jacket Dia. ²
22	22, 24, 26	.019-.032 .482-.813	—	—	.039-.054 .990-1.37
16 ³	16, 18, 20	.038-.061 .965-1.55	—	—	.065-.081 1.65-2.06
12	12 AWG	.071-.093 1.80-2.36	—	—	.096-.120 2.44-3.05
50 ohm	50 ohm	.013 .330 Max.	.032-.036 .813-.914	.048-.054 1.22-1.37	.065-.087 1.65-2.21
75 ohm	75 ohm	.013 .330 Max.	.060-.066 1.52-1.68	.078-.084 1.98-2.13	.096-.109 2.44-2.77
95 ohm	95 ohm	.013 .330 Max.	.100-.104 2.54-2.64	.115-.123 2.92-3.12	.137-.154 3.48-3.91

¹ Tolerance of conductor diameters required for a reliable crimp. Smaller sizes readily accommodated — consult Tyco Electronics.

² Smaller jacketed cable can be accommodated but environmental seal may be impaired. Smooth extruded jacket should be used for consistent wire sealing.

³ Size 16 AWG Contact for size 20 AWG Wire — Use Tool 010-0080-0000.

Test Data

MARC 43 Series Connectors meet the applicable performance requirements of specification MIL-C-26482 (Navy) to include the following selected test parameters listed below:

DESCRIPTION

MIL-C-26482 Test Para

TEST REQUIREMENTS

Insulation Resistance, Room and High Temp.,
Para. 4.7.3

Insulation resistance of unmated connectors shall be 5000 megohms, minimum at room temperature and 2000 megohms, minimum, at 257°F [+125°C] when measured per MIL-STD-202, Method 302, Test Condition B.

Dielectric Withstanding Voltage,
Para. 4.7.4

No evidence of dielectric breakdown or flashover when mated and unmated plugs are subjected to 1000 volts, rms, per MIL-STD-202, Method 301.

Durability,
Para. 4.7.9

Plugs and receptacles designed to withstand up to 500 cycles of engagement and separation without detrimental electrical or mechanical damage to the connectors.

Corrosion,
Para. 4.7.10

Unmated plugs and receptacles shall show no exposure of basis metal due to corrosion which would affect electrical or mechanical performance of the connectors after subjection to 24 hours exposure to salt spray atmosphere per MIL-STD 202, Method 101.

Sweep Vibration,
Mated, Para. 4.7.11

Mated connectors shall show no circuit interruptions greater than 10 microseconds during 12 hours vibration to include six sweeps in two axes at -67°F [-55°C], room temperature, and 257°F [+125°C] per MIL-STD-202, Method 204, Test Condition B. Post inspection shall show no detrimental cracking, breaking, or loosening of parts.

Moisture Resistance,
Para. 4.7.13 and 4.7.13.1

The insulation resistance of mated connectors shall exceed 100 megohms after subjection to moisture resistance testing per MIL-STD-202, Method 106.

Contact Retention,
Para. 4.7.16

Contacts shall withstand 15 lbs [66.7 N] axial load without axial displacement in excess of 0.012 [0.305] or damage to contacts or inserts when the axial load is applied to the mating end of the contacts in unmated plugs and receptacles at a rate of approximately 1 lb/sec.

Contact Arrangements¹

"A Size" Insert Layouts
(A =) Shell Size 9

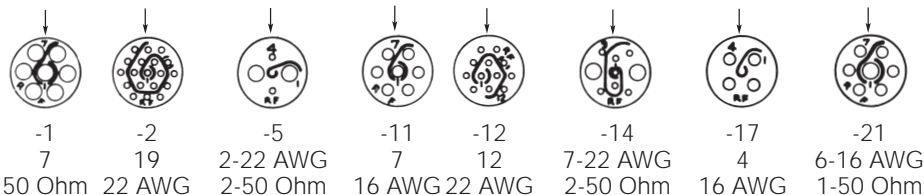

Insert Arrangement²
Number of Contacts
Contact Size

"B Size" Insert Layouts
(B =) Shell Size 12

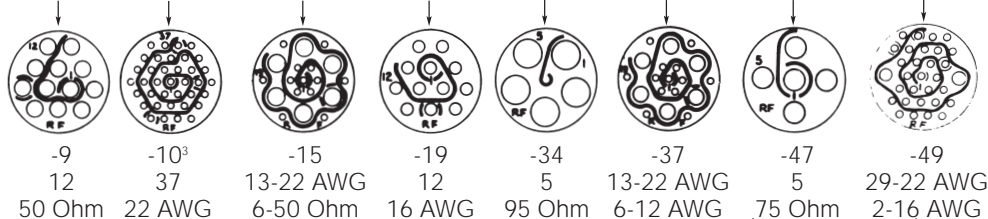

Insert Arrangement²
Number of Contacts
Contact Size

"C Size" Insert Layouts
(C =) Shell Size 15

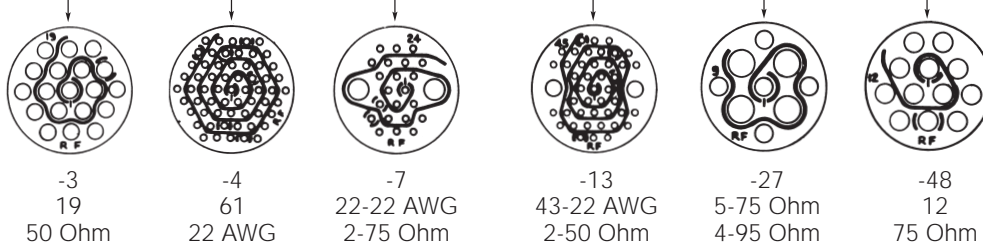

Insert Arrangement²
Number of Contacts
Contact Size

Notes: ¹ Views shown are front face view of receptacles. Front face view of plugs is mirror image of that shown.
² Arrow (Y) indicates insert top or vertical position in relation to top or vertical position of connector housings.
³ Arrangement also available in hermetic seal receptacles.

Part Number and Ordering Information

MARC 43 Series Connectors (Continued)

MARC 43 Series Connector part numbers indicate size, shape, insert layout, type of seal, style of contact and polarization. **Note:** Pin or socket (power or coaxial) contacts may be used in either plugs or receptacles. However, it is recommended that pins be placed in the receptacle when possi-

ble to take advantage of our "scoop-proof" design. (The style—pin or socket—of a coaxial contact refers to the outer contact body.)

Alternate Keying. Standard alternate polarizing key positions are shown below. Additional polarizing keyways are available upon request.

Supplemental Accessory Hardware. We also manufacture supplemental accessory hardware (protective covers, cable clamps, etc.) to adapt these connectors to almost any application. For modifications to fit your requirements, contact Tyco Electronics.

Typical Part Number

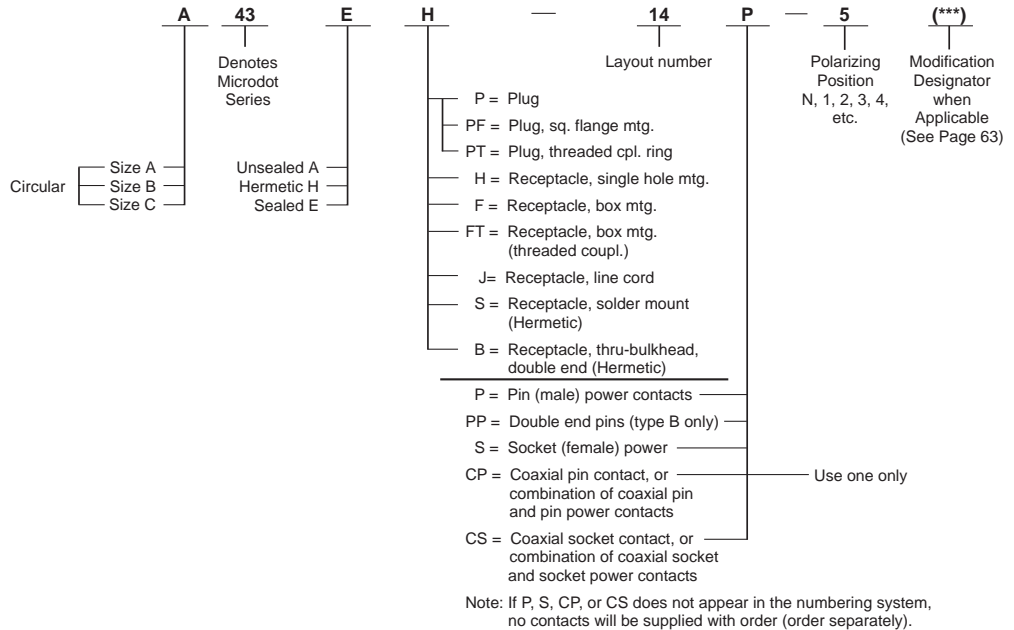

Polarizing Key Positions

All MARC 43 Series Connector multi-pin plugs and receptacles are available in alternate polarizing positions as listed below:

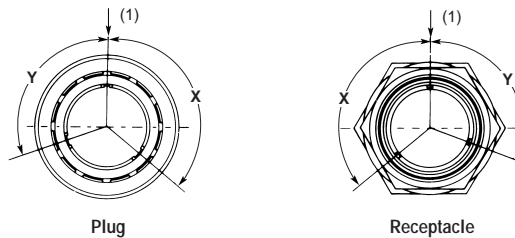

(1) Arrow (↑) indicates top or vertical position (master key-keyway) and coincides with top or vertical position of insert. This relationship remains constant with alternate polarizing key positions.

N—for Normal

Size A			Size B			Size C		
Part No.	X°	Y°	Part No.	X°	Y°	Part No.	X°	Y°
A43****N	130	110	B43****N	130	110	C43****N	130	110
A43****-1	130	150	B43****-1	130	90	C43****-1	130	90
A43****-2	90	110	B43****-2	130	145	C43****-2	130	150
A43****-3	210	110	B43****-3	105	110	C43****-3	130	170
A43****-4	130	35	B43****-4	155	110	C43****-4	190	110
A43****-5	90	230	B43****-5	80	110	C43****-5	150	110
			B43****-6	190	110	C43****-6	90	110
			B43****-7	130	170	C43****-7	70	110
			B43****-8	215	110	C43****-8	70	230
			B43****-9	80	230	C43****-9	90	230
			B43****-10	130	30	C43****-10	210	110
						C43****-11	30	110
						C43****-12	250	30
						C43****-13	130	30
						C43****-14	30	230

MARC 43 Series Connectors (Continued)

Configurations

Type P

Straight Plug, Push-Pull Coupling, Sealed or Unsealed (Mates with Receptacles, All Types)

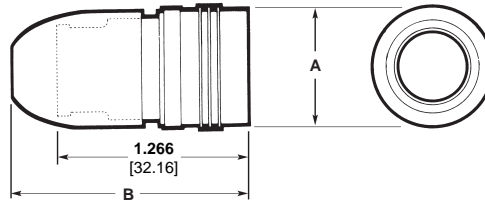

Shell Size	Dimensions	
	A	B
A	.766 19.46	1.578 40.08
B	.953 24.21	1.656 42.06
C	1.141 28.98	1.75 44.45

Type PF

Straight Plug, Square Flange Mounting, Push-Pull Coupling, Sealed or Unsealed (Mates with Receptacles, all Types.)

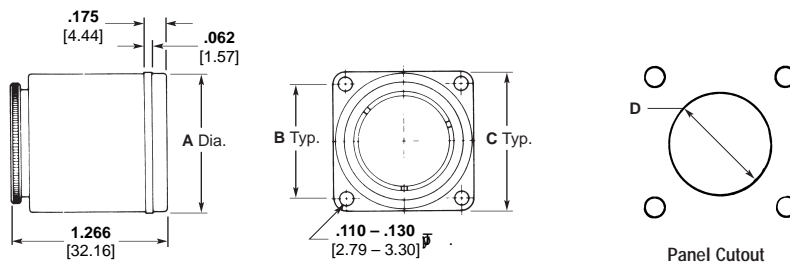

Shell Size	Dimensions			
	A	B	C	D
A	.730 18.54	.664 16.86	.875 22.23	.750 19.05
B	.920 23.37	.786 19.96	1.000 25.40	.940 23.88
C	1.110 28.19	.924 23.47	1.125 28.58	1.130 28.70

Type PT

Straight Plug, Threaded Coupling, Sealed or Unsealed (Mates with Receptacles, Types H, HH, and FT)

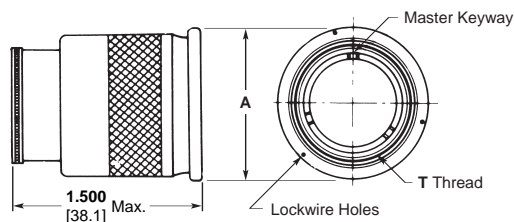

Shell Size	Dimensions	
	A	T (Class 2B)
A	.813 20.65	5/8-32 UN
B	1.000 25.40	13/16-28 UN
C	1.19 30.23	1-28 UN

MARC 43 Series Connectors (Continued)

Configurations (Continued)

Type H

Receptacle, Single Hole Mounting
Sealed or Unsealed
(Mates with Plugs, Types P, PF and PT)

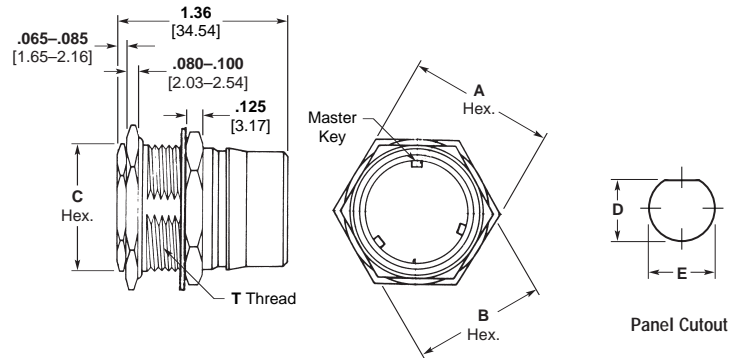

Shell Size	Dimensions					T (Class 2A)
	A	B	C	D	E	
A	.75 19.05	.687 17.45	.562 14.27	.607-.611 15.42-15.52	.625-.629 15.8-15.97	5/8-32 UN
B	.937 23.80	.875 22.23	.75 19.05	.794-.798 20.17-20.27	.812-.816 20.62-20.72	13/16-28 UN
C	1.125 28.58	1.062 26.97	.875 22.23	.975-.979 24.77-24.87	.999-1.003 25.37-25.47	1-28 UN

.313 [7.95] max. panel for P & PF
.109 [2.77] max. panel for PT

Type 43F

Receptacle, Box Mounting,
Sealed or Unsealed (Mates with Plugs, Types P and PF)

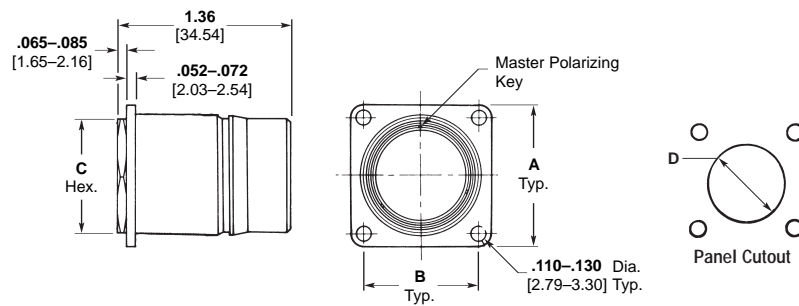

Shell Size	Dimensions			
	A	B	C	D
A	.875 22.23	.594 15.08	.562 14.27	.595 15.11
B	1.000 25.40	.786 19.96	.75 19.05	.783 19.89
C	1.125 28.58	.906 23.01	.875 22.23	.960 24.38

Note: Unless otherwise shown, tolerances are: Decimals ±.015 [±.381], fractions ±1/32.

MARC 43 Series Connectors (Continued)

Configurations (Continued)

Type FT

Receptacle, Box Mounting, Threaded Coupling, Sealed or Unsealed (Mates with Plugs, Types PT, P and PF)

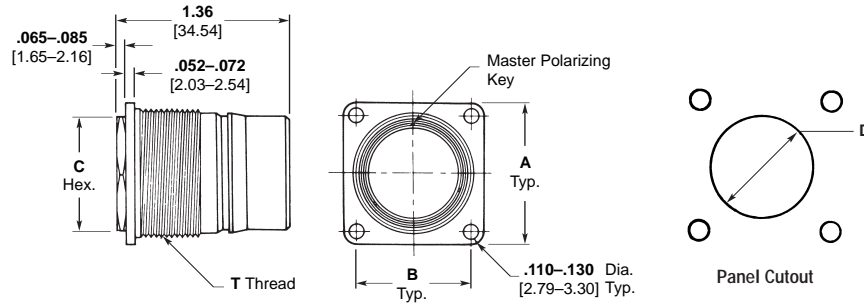

Shell Size	Dimensions			
	A	B	C	T (Class 2A)
A	.875 22.23	.594 15.08	.562 14.27	5/8-32 UN 16.38
B	1.000 25.40	.786 19.96	.75 19.05	13/16-28 UN 21.13
C	1.125 28.58	.906 23.01	.875 22.23	1-28 UN 25.90

Max. panel thickness is .125 [3.18].

Type J

Receptacle, Line Cord, Sealed or Unsealed (Mates with Plugs, Types P and PF)

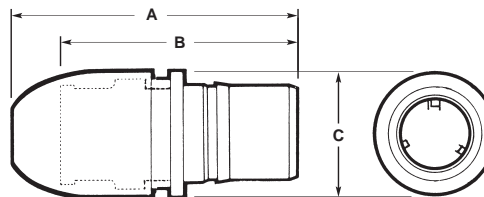

Shell Size	Dimensions		
	A	B	C
A	1.703 43.26	1.36 34.54	.766 19.46
B	1.781 45.24	1.36 34.54	.953 24.21
C	1.875 47.63	1.36 34.54	1.141 28.98

Note: Unless otherwise shown, tolerances are: Decimals ± 0.015 [± 0.381], fractions $\pm 1/32$.

Accessories

Cable Clamps

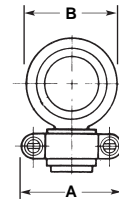
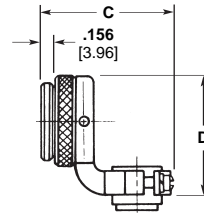
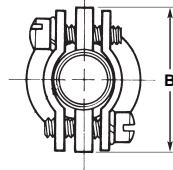
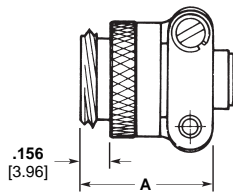

Straight

Right-Angle

Shell Size	Part No.	A [Max.]	B [Max.]
A	086-0099-00X1	.704 17.88	.750 19.05
B	086-0100-00X1	.773 19.63	.932 23.67
C	086-0101-00X1	.829 21.05	1.078 27.38

Shell Size	Part No.	A [Max.]	B [Max.]	C [Max.]	D [Max.]
A	086-0103-00X1	.737 18.72	.600 15.24	1.100 27.94	.879 22.33
B	086-0104-00X1	.913 23.19	.770 19.55	1.250 31.75	1.067 27.10
C	086-0105-00X1	1.048 26.62	.962 24.43	1.469 37.31	1.233 31.32

Contacts (see pages 78 and 79)

Contact Size	Pin Part No.	Socket Part No.
22 AWG	083-0009-00R4	082-0464-00Y9
16 AWG	083-0158-00R4	082-0113-00T1
12 AWG	083-0173-00R4	082-0132-00T1
50 ohm Coaxial (Solder Type)	084-0024-00T2	084-0027-00T2
50 ohm Coaxial (Crimp Type)	141-1500-0001	142-1500-0001
75 ohm Coaxial	084-0025-00T2	084-0028-00T2
95 ohm Coaxial	084-0026-00T2	084-0029-00T2

Contact Cavity Sealing Plugs (see page 80)

Contact Size	Sealed Connector Part No.	Unsealed Connector Part No.
22 AWG	086-0055-0000	086-0001-0000
16 AWG	086-0056-0000	086-0014-0000
12 AWG	086-0057-0000	086-0015-0000
50 ohm Coaxial	086-0058-0000	086-0061-0000
75 ohm Coaxial	086-0059-0000	086-0062-0000
95 ohm Coaxial	086-0060-0000	086-0063-0000

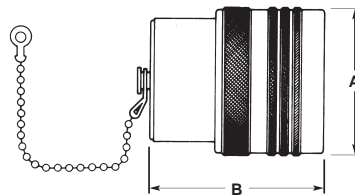

Receptacle Cover

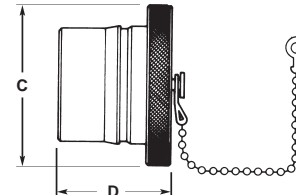

Plug Cover

Protective Covers

Shell Size	Receptacle Cover Part No. ¹		Plug Cover Part No. ¹		Dimensions (Max.)			
	With Chain	Without Chain	With Chain	Without Chain	A	B	C	D
A	086-0049-00J2	086-0073-00P1	086-0052-00J2	086-0076-00P1	.766 19.46	.950 24.13	.969 24.62	.913 23.19
B	086-0050-00J2	086-0074-00P1	086-0053-00J2	086-0077-00P1	.953 24.21	.950 24.13	1.156 29.36	.913 23.19
C	086-0051-00J2	086-0075-00P1	086-0054-00J2	086-0078-00P1	1.141 28.98	.950 24.13	1.344 34.14	.913 23.19

¹ For threaded plug (PT) and receptacle (FT) covers, consult Tyco Electronics. Wire rope/laneyard attachments and plastic protective caps also available, consult Tyco Electronics.

Modifications

The MARC 43 Series Connector modification identification system provides alteration of standard MARC 43 Series Connectors to include special finishes, accessories, MARC 53 Series Connector housings, and custom quality assurance provisions — processing, testing, serialization, traceability. Consult your sales representative or Tyco Electronics for additional modification information.

Standard modifications include:

- (009): MARC 43 Series Connector, anodized finish — black.
- (048): MARC 43 Series Connector, iridite finish — gold.
- (056): MARC 43 Series Connector, cadmium plated — clear.
- (057): MARC 43 Series Connector including cable clamp, straight type.
- (078): MARC 43 Series Connector insert arrangement plus MARC 53 Series Connector positive lock coupling.
- (094): MARC 43 Series Connector coaxial insert arrangement to include all-crimp coaxial contacts plus MARC 53 Series Connector positive lock coupling.
- (098): MARC 43 Series Connector connector including cable clamp, right-angle type.

General Information

The MARC 53 Series Connector family represents a major advancement in the design of high density (.080 [2.03] contact centers), sub-miniature, power and coaxial contact connectors. The MARC 53 Series Connectors consists of two connector styles — the Military approved MD53 featuring shoulder entrapped contacts, and the new RMD53 utilizing rear insertable/removable contacts. MARC 53 Series Connectors combine positive lock — the rugged, push-pull, lock-coupling mechanism — with the unique positive seal multiple sealing system.

Positive lock is our new finger-tip, push-pull coupling with the safety lock feature, and is the only connector made with positive "blind mating" indication. When the plug is fully engaged, the coupling ring can be rotated 45° to the safety lock position; if the plug is not

completely engaged, the coupling ring cannot be turned to the safety lock position. Consequently, under "blindmating" conditions, it is always possible to determine if the plug is properly engaged without visual reference, damage, or accidental disengagement.

The environmental integrity is guaranteed by multiple seal construction using silicone rubber "O" rings and a floating, voidless insert construction. The floating insert design allows the inserts to move within the connector housing to control interfacial sealing pressure in spite of tolerance accumulation, and a compression interfacial seal with minimum engaging force. Both the primary "O" ring system and the continuous dielectric construction withstand the MIL-C-38300A altitude breathing test. The sealing system meets the air leakage requirements of not more than 1 cubic inch

of air per hour at a 30 P.S.I. pressure differential. This redundant sealing method is indicative of the inherent reliability built into our connectors.

MARC 53 Series Connector power contacts are manufactured from high grade copper alloys, and are designed to be crimped with standard M22520 tooling using subminiature contact locators.

MARC 53 Series Connectors incorporate hard insulators in both the plug and receptacle inserts for exceptional contact stability. Shoulder entrapment positively retains the front insertable MD53 contacts between the front and rear insulators. The new RMD53 contacts are rear insertable and removable and are retained within the connector insulators by clips which can be visually inspected. No insertion or extraction tools are

required for either the MD53 or RMD53 contacts using nominal size wire.

MARC 53 Series Connectors are truly field serviceable... no special tools are required for maintainability. In addition, connector subcomponents damaged through handling or misuse can be procured separately generally without the need to scrap entire connector units.

Weight reductions as high as 67% are achieved without loss of performance.

MARC 53 Series Connectors are available in both environmental and hermetic styles. In addition to the positive lock plug, a threaded coupling plug is also available. Part numbers for configurations offering various finishes and accessories plus other design variations to satisfy special requirements are also available.

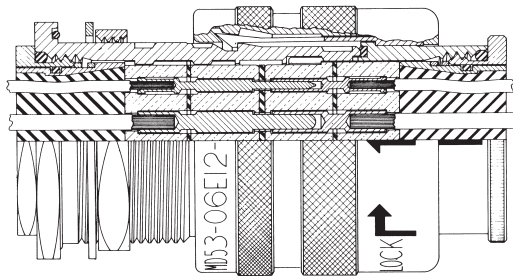

MD53
shoulder entrapped contacts

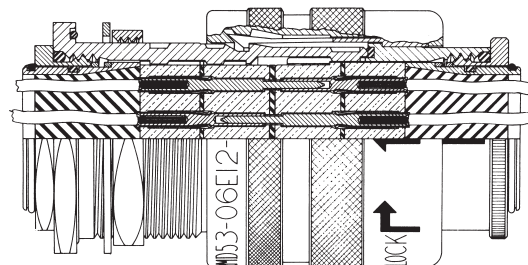

RMD53
rear insertable contacts

Materials and Finishes

Housings and quick disconnect couplings are machined from bar stock aluminum to combine maximum strength with minimum weight. Threaded couplings are machined from non-magnetic, stainless steel bar stock for durability of the coupling threads. Contacts are manufactured from high conductivity copper alloys which have been selected

for low contact resistance over the operating range of the connectors. Inserts are molded from flame-resistant, glass-filled diallyl phthalate, meeting ASTM D5948 requirements. All resilient parts are made of high-temperature, silicone elastomers. Fuel resistant compounds are used where swelling affects the performance of the

connector. All materials are selected for their non-magnetic properties. The standard finish is hard black, non-conductive, anodized finish on connector housings and quick disconnect couplings; stainless steel threaded coupling is passivated with black oxide finish. Conductive finish modifications include gold

finish and electroless nickel finish. Multi-finish modifications for connector plugs include black anodized disconnect coupling with conductive finish on shell grounding members. Contacts are gold plated per MIL-G-45204 requirements. See Page 73 for modification information.

MARC 53 Series Connectors (Continued)

I. Electrical — Electrical Ratings

Contact Size	Current Rating (Amperes, Max., 81°F [+27°C])	Dielectric Withstanding Voltage (RMS)	Working Voltage		Contact Resistance (Millivolts, Max.)
			Sea Level	110,000 ¹ Ft. Alt.	
22 AWG	5	1000	750	300	15
16 AWG	20	1000	750	300	20

¹ 10,000 ft equals 33,528 m altitude.

Wire Sizes Accommodated

Contact Size	Cond. Dia. (Stranded) ¹	Jacket Size ²
22 AWG	.019-.032 [.483-.813]	.039-.054 [.991-1.37]
16 AWG	.038-.061 [.965-1.55]	.065-.081 [1.65-2.05]

¹ Tolerance of conductor diameters required for a reliable crimp. Smaller sizes readily accommodated — consult Tyco Electronics.

² Smaller jacketed cable can be accommodated but environmental seal may be impaired. Smooth extruded jacket should be used for consistent wire sealing.

Insulation Resistance: 5000 megohms, minimum, at room ambient conditions.

II. Mechanical — Durability: 500 Cycles Mate/Unmate.
Coupling/Uncoupling Forces and Tightening Torques:

Shell Size	Coupling/Uncoupling Force (In-Lbs.) Max.	Tightening Torque (In-Lbs.)	
		Retaining Nut	Mounting Nut
9	18 [80.07 N]	20 [2.26 Nm], Max.	30-45 [3.39 – 5.08 Nm]
12	22 [97.86 N]	20 [2.26 Nm], Max.	40-55 [4.52 – 6.21 Nm]
15	27 [120.10 N]	20 [2.26 Nm], Max.	55-70 [6.21 – 7.91 Nm]
18	32 [142.34 N]	20 [2.26 Nm], Max.	70-85 [7.91 – 9.60 Nm]

Operating Temperature: -67°F to 257°F [-55°C to +125°C]
Connector Mated Length: MD Plug (06) mated to MD Receptacles (00) (01) (02) (12): 2.031 [51.58], max. RMD Plug (06) mated to RMD Receptacles: 2.217 [56.31], max.

Test Data

MARC 53 Series Connectors exceed the requirements of specification MIL-C-38300A (USAF) as detailed in the applicable M38300A (USAF) military specification sheets.

MARC 53 Series Connectors meet the following selected test parameters as specified below:

DESCRIPTION MIL-C-38300 Test Para	TEST REQUIREMENTS
Contact Retention Para. 4.10.3	MD Contacts shall withstand 15 lbs [66.72 N] axial load and RMD contacts 10 lbs [44.48 N] axial load without axial displacement in excess of 0.012 [.305] or damage to contacts or inserts when the axial load is applied to the mating end of the contacts in unmated plugs and receptacles at a rate of approximately 1 lb/sec. [4.45 N].
Contact Resistance Para. 4.10.8	The potential drop across normally mated contacts shall not exceed 25 mv under room ambient and high temperature service conditions when measured as specified in MIL-C-26636, Fig. 2, with maximum rated current.
Dielectric Withstanding Voltage, Altitude and Sea Level Para. 4.10.10	No evidence of dielectric breakdown or flashover when mated and unmated plugs are subjected to 645 and 180 volts RMS, respectively, at altitudes up to 110,000 feet [33,528 m] and 1000 volts RMS at sea level.
Insulation Resistance, Room and High Temp. Para. 4.10.13 and 4.10.13.1	Insulation resistance of mated plugs and receptacles shall be 5000 megohms, minimum, at room temperature and 1000 megohms, minimum, at 257°F [+125°C] when measured per MIL-STD-202, Method 302, Test Condition B.
Coupling and Uncoupling Para. 4.11.3	Plugs and receptacles shall withstand up to 500 cycles of engagement and separation (locking mechanism actuated with each cycle) without detrimental damage to plugs or receptacles or not satisfying subsequent tests of MIL-C-38300.
Fluid Immersion Para. 4.11.5	Mating and unmating forces shall not exceed 27 lbs, [120.10 N] maximum, (15 shell size) after fully wired plugs and receptacles are immersed for 20 hours, each, in hydraulic fluid (MIL-H-5606) and high temperature lubricating oil (MIL-L-9236) followed by a one-hour dry.
Sweep Vibration, Mated Para. 4.11.6	Mated connectors shall show no circuit interruptions greater than one microsecond during 12 hours vibration to include six sweeps in each axis at extreme temperatures of -85°F [-65°C] and 257°F [+125°C] per MIL-STD-202, Method 204, Test Condition D. Post inspection shall show no detrimental cracking, breaking, or loosening of parts.
Moisture Resistance Para. 4.11.8	The insulation resistance of mated connectors shall exceed 1000 megohms after subjection to moisture resistance testing per MIL-STD-202, Method 106, as amended by MIL-C-38300.
Altitude Breathing Para. 4.11.12	The insulation resistance of wired and mated connectors shall be 5000 megohms, minimum, and there shall be no flashover or breakdown at a test voltage of 1000 volts RMS after the third cycle and while immersed in 5% salt water solution at 68°F [20°C] and room ambient pressure pressure at 68°F [20°C].
Salt Spray Para. 4.11.13	Unmated plugs and receptacles shall show no excessive corrosion which would detrimentally affect the electrical and mechanical performance of the connectors after subjection to 24 hours exposure to salt spray atmosphere per MIL-STD-202, Method 101.

MARC 53 Series Connectors (Continued)

Contact Arrangements ^{1,2}

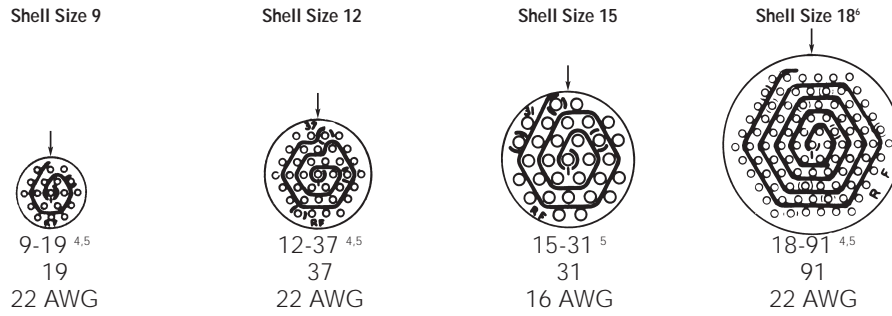

Insert Arrangement ³
Number of Contacts
Contact Size

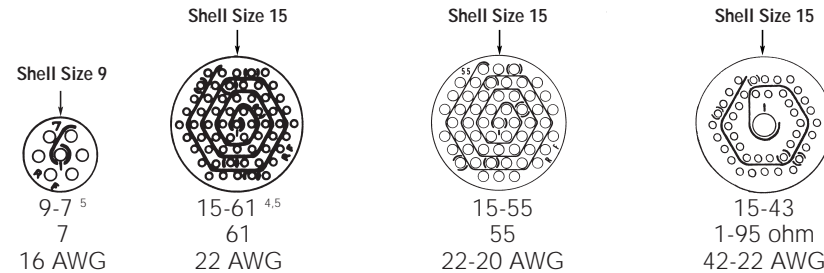

Insert Arrangement ³
Number of Contacts
Contact Size

¹ Views shown are front face view of receptacles. Front face view of plugs is mirror image of that shown.
² In addition to those inserts shown, MARC 43 Series Connector inserts may be utilized in MARC 53 Series Connector housings. See page 63, MARC 43 Series Connector modifications.
³ Arrow (↑) indicates insert top or vertical position in relation to top or vertical position of connector housings.
⁴ Arrangement also available in RMD style.
⁵ Arrangement also available in hermetic seal receptacles.
⁶ Arrangement available in 06, 00, 01.

Part Number and Ordering Information

MARC 53 Series Connector part numbers indicate size, shape, insert layout, type of seal, style of contact and polarization.

Note: Pin or socket (power or coaxial) contacts may be used in either plugs or receptacles. However, it is recommended that pins be placed in the receptacles when possible to take advantage of our "scoop-proof" design.

Alternate Keying — Standard alternate polarizing key positions are shown below. Additional polarizing keyways are available upon request.

Supplemental Accessory Hardware — We also manu-

facture supplemental accessory hardware (protective covers, shield adapters, etc.) to adapt these connectors to almost any application. For modifications to fit your requirements, contact Tyco Electronics.

Typical Part Number

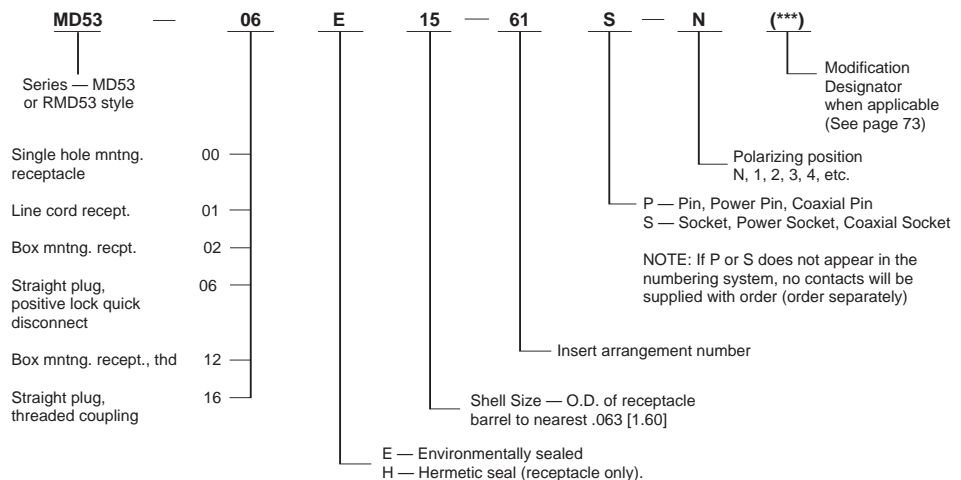

MARC 53 Series Connectors (Continued)

Polarizing Key Positions

All of our multi-pin plugs and receptacles are available in alternate polarizing positions as listed below:

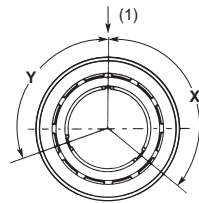

Plug
(Shell sizes 9, 12, 15 only)

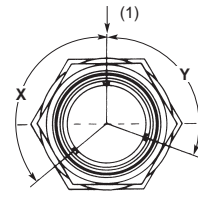

Receptacle
(Shell sizes 9, 12, 15 only)

Shell Size 9		
Part No.	X°	Y°
(R) MD53-***9-***-N	130	110
(R) MD53-***9-***-1	130	150
(R) MD53-***9-***-2	90	110
(R) MD53-***9-***-3	210	110
(R) MD53-***9-***-4	130	35
(R) MD53-***9-***-5	90	230

Shell Size 12		
Part No.	X°	Y°
(R) MD53-***12-***-N	130	110
(R) MD53-***12-***-1	130	90
(R) MD53-***12-***-2	130	145
(R) MD53-***12-***-3	105	110
(R) MD53-***12-***-4	155	110
(R) MD53-***12-***-5	80	110
(R) MD53-***12-***-6	190	110
(R) MD53-***12-***-7	130	170
(R) MD53-***12-***-8	215	110
(R) MD53-***12-***-9	80	230
(R) MD53-***12-***-10	130	30

Shell Size 15		
Part No.	X°	Y°
(R) MD53-***15-***-N	130	110
(R) MD53-***15-***-1	130	90
(R) MD53-***15-***-2	130	150
(R) MD53-***15-***-3	130	170
(R) MD53-***15-***-4	190	110
(R) MD53-***15-***-5	150	110
(R) MD53-***15-***-6	90	110
(R) MD53-***15-***-7	70	110
(R) MD53-***15-***-8	70	230
(R) MD53-***15-***-9	90	230
(R) MD53-***15-***-10	210	110
(R) MD53-***15-***-11	30	110
(R) MD53-***15-***-12	250	30
(R) MD53-***15-***-13	130	30
(R) MD53-***15-***-14	30	230

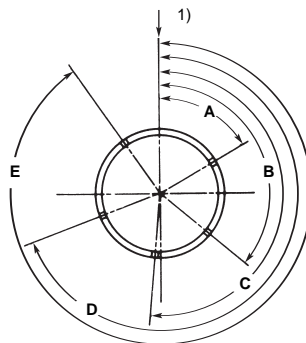

Plug
(Shell size 18 only)

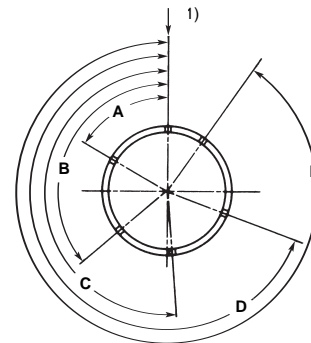

Receptacle
(Shell size 18 only)

Shell Size 18					
Part No.	A°	B°	C°	D°	E°
(R) MD53-***18-***-N	60	130	185	250	325
(R) MD53-***18-***-1	70	130	205	270	320
(R) MD53-***18-***-2	55	130	210	250	310
(R) MD53-***18-***-3	50	130	190	235	305
(R) MD53-***18-***-4	75	125	190	250	320
(R) MD53-***18-***-5	80	150	205	250	300
(R) MD53-***18-***-6	50	90	175	250	315
(R) MD53-***18-***-7	70	120	175	250	295
(R) MD53-***18-***-8	70	130	205	260	325
(R) MD53-***18-***-9	35	90	130	215	285
(R) MD53-***18-***-10	75	140	210	250	310

⁽¹⁾ Arrow (↑) indicates top or vertical position (master key/keyway) and coincides with top or vertical position of insert shown on page 59. This relationship remains constant with alternate polarizing key positions.
(R) Rear insertable and removable.

MARC 53 Series Connectors (Continued)

Configurations

MD53-06E/RMD53-06E

Straight Plug, positive lock
Coupling, Environmental
(Mates with Receptacles,
All Types)

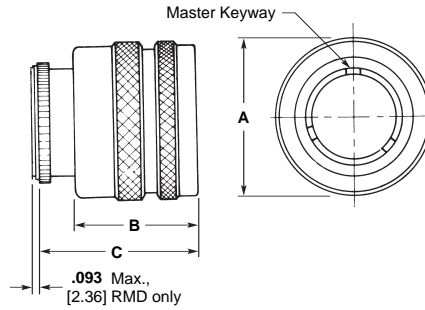

Shell Size	Dimensions		
	A	B (Max.)	C (Max.)
9	.890	1.000	1.281
	22.60	25.4	32.54
12	1.078	1.000	1.281
	27.38	25.4	32.54
15	1.262	1.000	1.281
	32.05	25.4	32.54
18	1.577	1.000	1.281
	40.06	25.4	32.54

MD53-16E/RMD53-16E

Straight Plug, Threaded
Coupling, Environmental
(Mates with Receptacles,
Types 00 and 12; Not avail-
able in 18 Shell Size)

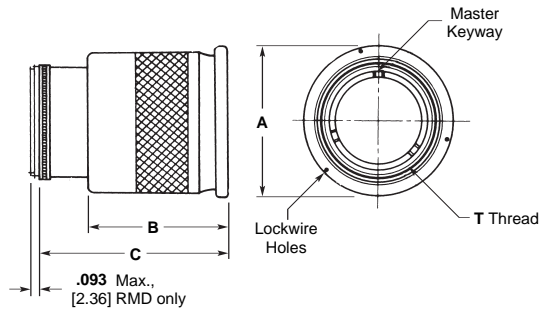

Shell Size	Dimensions			
	A	B (Max.)	C (Max.)	T (Class 2B)
9	.812	1.125	1.500	5/8-32UN
	20.62	28.57	38.1	
12	1.000	1.125	1.500	13/16-28UN
	25.4	28.57	38.1	
15	1.187	1.125	1.500	1-28UN
	30.15	28.57	38.1	
18	1.437	1.125	1.437	1-1/4-28UN
	36.50	28.57	36.50	

MARC 53 Series Connectors (Continued)

Configurations (Continued)

MD53-00E/RMD53-00E

Receptacle, Single Hole Mounting, Environmental (Mates with Plugs, Type 06 and 16)

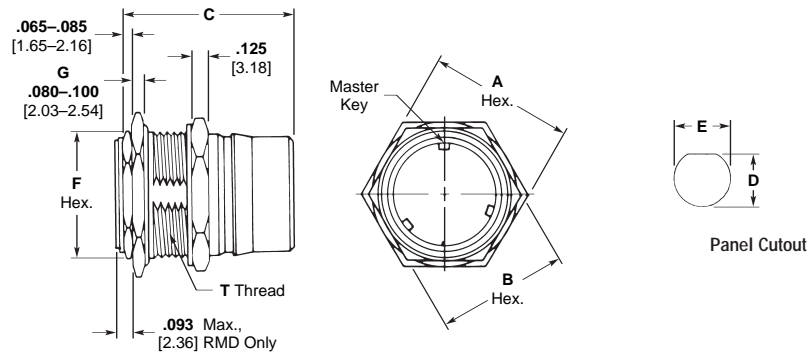

Shell Size	Dimensions							T (Class 2A)
	A	B	C	D	E	F	G	
9	.75 19.05	.687 17.45	1.360 34.54	.607-.611 15.42-15.52	.625-.629 15.87-15.97	.563 14.30	.090 2.29	5/8-32NS
12	.937 23.80	.875 22.23	1.360 34.54	.794-.798 20.17-20.27	.812-.816 20.62-20.73	.75 19.05	.090 2.29	13/16-28NS
15	1.125 28.58	1.062 26.97	1.360 34.54	.975-.979 24.76-24.86	.999-1.003 25.37-25.48	.875 22.23	.090 2.29	1-28UNS
18	1.625 41.28	1.375 34.93	1.360 34.54	1.214-1.218 30.83-30.94	1.251-1.255 31.77-31.87	1.125 28.58	.125 3.18	1-1/4-28UN

Note: .313 [7.95] Maximum Panel Thickness when mated with a positive lock 06 Plug.
.109 [2.77] Maximum Panel Thickness when mated with threaded 16 Plug.

MD53-01E/RMD53-01E

Receptacle, Line Cord, Environmental (Mates with Plug, Type 06)

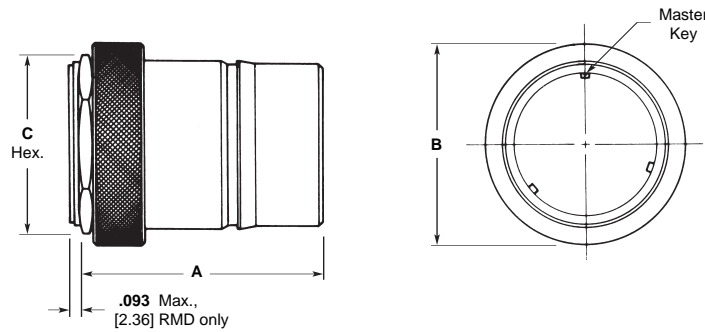

Shell Size	Dimensions		
	A (Max.)	B (Max.)	C
9	1.360 34.54	.766 19.46	.562 14.27
12	1.360 34.54	.953 24.21	.75 19.05
15	1.360 34.54	1.141 28.98	.875 22.23
18	1.360 34.54	1.578 40.08	1.125 28.58

Note: Unless otherwise shown, tolerances are: decimals $\pm .015$ [$\pm .381$]; fractions $\pm 1/32$.

MARC 53 Series Connectors (Continued)

Configurations (Continued)

MD53-02E/RMD53-02E

Receptacle, Box Mounting, Environmental (Mates with Plug, Type 06)

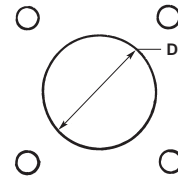
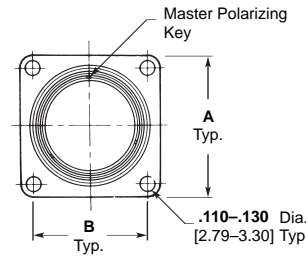
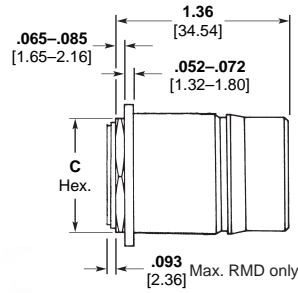

Panel Cutout

.375 [9.53] Max. Panel Thickness for rear-mount applications.

Shell Size	Dimensions			
	A	B	C	D
9	.875 22.23	.594 15.09	.563 14.30	.595 15.11
12	1.000 25.40	.786 19.96	.75 19.05	.783 19.89
15	1.125 28.58	.906 23.01	.875 22.23	.960 24.38
18	1.344 34.14	1.062 26.97	1.125 28.58	1.212 30.78

MD53-12E/RMD53-12E Threaded Coupling

Receptacle, Box Mounting, Environmental (Mates with Plugs, Type 06 and 16; not available in 18 Shell Size)

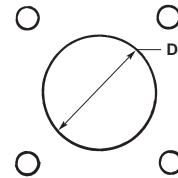
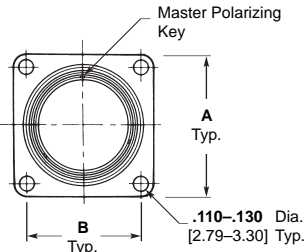
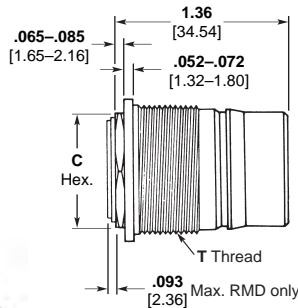

Panel Cutout

.125 [3.18] Max. Panel Thickness when mated with threaded 16 Plug for rear mount applications.

Shell Size	Dimensions				
	A	B	C	T (Class 2A)	D
9	.875 22.23	.594 15.09	.563 14.30	5/8-32UN	.645 16.38
12	1.000 25.40	.786 19.96	.75 19.05	13/16-28UN	.832 21.13
15	1.125 28.58	.906 23.01	.875 22.23	1-28UN	1.020 25.91

Note: Unless otherwise shown, tolerances are: decimals ± .015 [±.381]; fractions ± 1/32.

MARC 53 Series Connectors (Continued)

Accessories

Test Adapter

The test adapter accessory is utilized primarily as a connector simulator to preserve the end-use connector where this connector would be subjected to extensive testing, matings, or probings. The test adapter, when mated, provides the exact mating interface as that of the end-use connector and is completely field serviceable.

Test Adapter Product Part Number System

How to Specify

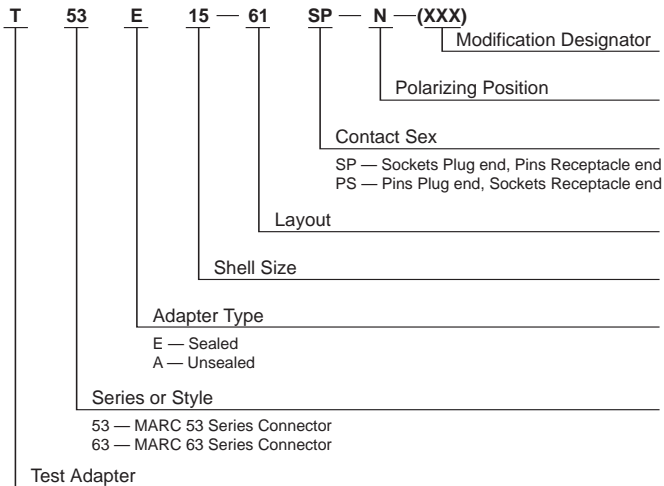

Shell Size	Dimension	
	A (Max.)	B (Max.)
9	.906 23.01	2.670 67.82
12	1.094 27.79	2.670 67.82
15	1.281 32.54	2.670 67.82
18	1.594 40.49	2.670 67.82

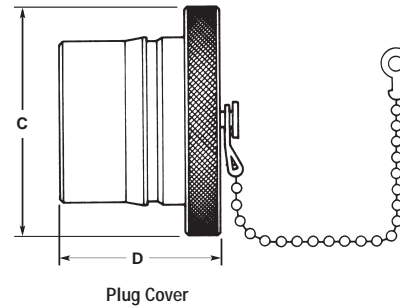
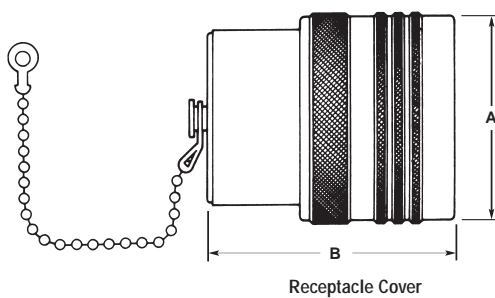
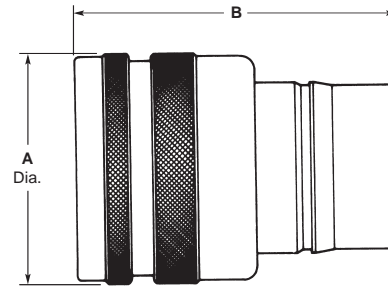

Protective Covers

Shell Size	Receptacle Cover Part No. ¹		Plug Cover Part No. ¹		Dimensions (Max.)			
	With Chain	Without Chain	With Chain	Without Chain	A	B	C	D
9	086-0049-00AL	086-0073-00W3	086-0052-00L6	086-0076-00P2	.766 19.46	.950 24.13	.969 24.61	.913 23.19
12	086-0050-00AL	086-0074-00W3	086-0053-00L6	086-0077-00P2	.953 24.21	.950 24.13	1.156 29.36	.913 23.19
15	086-0051-00AL	086-0075-00W3	086-0054-00L6	086-0078-00P2	1.141 28.98	.950 24.13	1.344 34.14	.913 23.19
18	086-0146-00AL	086-0139-00W3	086-0147-00L6	086-0140-00P2	1.578 40.08	1.000 25.4	1.781 45.24	.913 23.19

¹ For threaded plug (PT) cover, consult Tyco Electronics. Wire rope/lanyard attachments and plastic protective caps also available, consult Tyco Electronics.

Accessories (Continued)

Cable Clamps

Shell Size	Clamp Part No.		A	B	T Thd. 2A
	MD	RMD			
9	086-0099-00F5	086-0175-00F3	.704 17.88	.750 19.05	1/2-20 UNF
12	086-0100-00F5	086-0176-00F3	.773 19.63	.932 23.67	11/16-24 UNEF
15	086-0101-00F5	086-0177-00F3	.829 21.06	1.078 27.38	13/16-24 UNEF
18	086-0142-00F5	086-0178-00F3	.890 22.61	1.250 31.75	1-28 UN

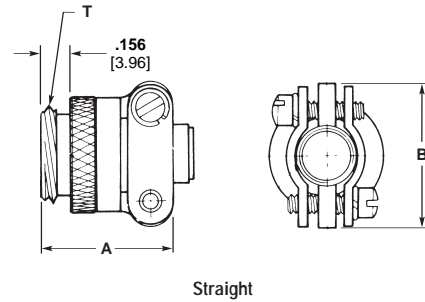

Straight

Shell Size	Clamp Part No.		A	B (Max.)	C (Max.)	D	T Thd. 2A
	MD	RMD					
9	086-0103-00F5	086-0179-00F3	.737 18.72	.600 15.24	1.100 27.94	.879 22.32	1/2-20 UNF
12	086-0104-00F5	086-0180-00F3	.913 23.19	.775 19.68	1.250 31.75	1.067 27.10	11/16-24 UNEF
15	086-0105-00F5	086-0181-00F3	1.048 26.62	.962 24.43	1.469 37.31	1.233 31.32	13/16-20 UNEF
18	086-0143-00F5	086-0182-00F3	1.225 31.12	1.185 30.01	1.550 39.37	1.550 39.37	1-28 UN

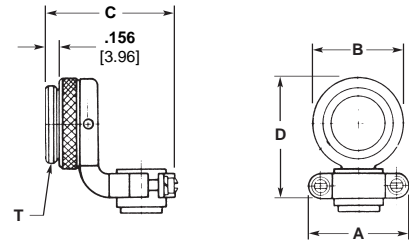

Right-Angle

Contacts (see pages 78 and 79)

Contact Size	Pin Part No.		Socket Part No.	
	MD	RMD	MD	RMD
22 AWG	083-0009-00R4	083-1200-00R4	082-0464-00Y9	082-0462-00Y9
16 AWG	083-0158-00R4	—	082-0113-00T1	—

Note: Standard packaging includes same quantity of contacts as contact cavities in insert.

Contact Cavity Sealing Plugs (see page 80)

Contact Size	Standard Length Part No.		Short Length Part No.	
	MD	RMD	MD	RMD
22 AWG	086-0055-0000	086-0148-0000	082-0009-0000	086-0009-0000
16 AWG	086-0056-0000	—	082-0010-0000	—

Note: Standard length plug occupies contact cavity and wire sealing grommet. Short length plug occupies wire sealing grommet only (to be used behind non-wired contacts and in plugs which mate to hermetic receptacles).

Modifications

We offer a unique modification identification system which provides alteration of standard MARC 53 Series Connectors to include special finishes, accessories, MARC 43 Series Connector contact arrangements, and custom quality assurance provisions — processing, testing, serialization, traceability. Consult Tyco Electronics for additional modification information.

Standard modifications include:

- (503): MARC 53 Series Connector including cable clamp, straight type
- (504): MARC 53 Series Connector including cable clamp, right-angle type
- (506): MARC 53 Series Connector, gold finish

- (507): MARC 53 Series Connector, electroless nickel finish
- (508): MARC 53 Series Connector, black anodized coupling ring, gold over electroless nickel housings, retaining nuts and hardware.

MARC 63 Series Connectors RMD63 Performance Data

MARC 63 Series Connectors, RMD63 Series meet or exceed the performance requirements of specification MIL-C-38300A (USAF) as detailed in the M38300A (USAF) military specification sheets covering the MARC 63 Series Connectors. Tyco Electronics can supply detailed, cross reference information. MARC 63 Series Connectors, RMD63 Series meet the following selected test parameters as specified below:

DESCRIPTION	TEST REQUIREMENTS
Contact Retention	Contacts are to withstand 15 lbs. [66.72 N] axial load and RMD contacts 10 lbs. [44.48 N] axial load without axial displacement in excess of 0.012 [.305] or damage to contacts or inserts when the axial load is applied to the mating end of the contacts in unmated plugs and receptacles at a rate of approximately 1 lb/sec. [4.45 N].
Contact Resistance	The potential drop across normally mated contacts shall not exceed 25 mv under room ambient and high temperature service conditions when measured as specified in MIL-C-26636, Fig. 2, with maximum rated current.
Dielectric Withstanding Voltage, Altitude and Sea Level	No evidence of dielectric breakdown or flashover when mated and unmated plugs are subjected to 645 and 180 volts RMS, respectively, at altitudes up to 110,000 [33,528 m] feet and 1000 volts RMS at sea level.
Insulation Resistance, Room and High Temp.	Insulation resistance of mated plugs and receptacles shall be 5000 megohms, minimum, at room temperature and 1000 megohms, minimum, at 257°F [+125°C] when measured per MIL-STD-202, Method 302, Test Condition B.
Coupling and Uncoupling	Plugs and receptacles shall withstand up to 500 cycles of engagement and separation without detrimental damage to plugs or receptacles or not satisfying subsequent tests of MIL-C-38300.
Fluid Immersion	Mating and unmating forces shall not exceed 27 lbs. [120.10 N], maximum, (15 shell size) after fully wired plugs and receptacles are immersed for 20 hours, each, in hydraulic fluid (MIL-H-5606) and high temperature lubricating oil (MIL-L-9236) followed by a one-hour dry.
Sweep Vibration, Mated	Mated connectors shall show no circuit interruptions greater than one microsecond during 12 hours vibration to include six sweeps in each axis at extreme temperatures of -85°F [-65°C] and 257°F [+125°C] per MIL-STD-202, Method 204, Test Condition D. Post inspection shall show no detrimental cracking, breaking, or loosening of parts.
Moisture Resistance	The insulation resistance of mated connectors shall exceed 1000 megohms after subjection to moisture resistance testing per MIL-STD-202, Method 106, as amended by MIL-C-38300.
Altitude Breathing	The insulation resistance of wired and mated connectors shall be 5000 megohms, minimum, and there shall be no flashover or breakdown at test voltage of 1000 volts RMS after the third cycle and while immersed in 5% salt water solution at 68°F [20°C] and room ambient pressure at 68°F [20°C].
Salt Spray	Unmated plugs and receptacles shall show no excessive corrosion which would detrimentally affect the electrical and mechanical performance of the connectors after subjection to 24 hours exposure to salt spray atmosphere per MIL-STD-202, Method 101.

MARC 63 Series Connectors (Continued)

Part Number and Ordering Information

Connector part numbers indicate size, shape, insert layout, type of seal, style of contact and polarization.

Note: Pin or socket (power or coaxial) contacts may be used in either plugs or receptacles. However, it is recommended that pins be placed in the receptacle when possible to take advantage of our "scoop-proof" design.

Typical Part Number

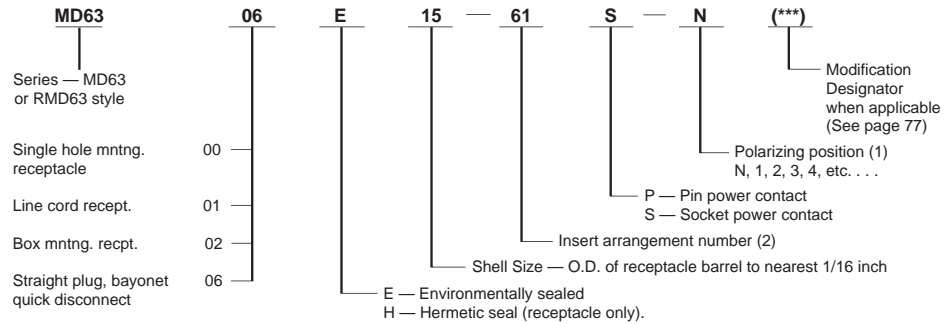

(1) For polarizing key positions see MARC 53 Series Connectors.
 (2) For contact arrangements see MARC 53 Series Connectors.
Note: If P or S does not appear in the numbering system, no contacts will be supplied with order (order separately).

Configurations

MD63-06E/RMD63-06E

Straight Plug, Bayonet Coupling, Environmental and Non-Environmental (Mates with Receptacles 02, 00 and 01)

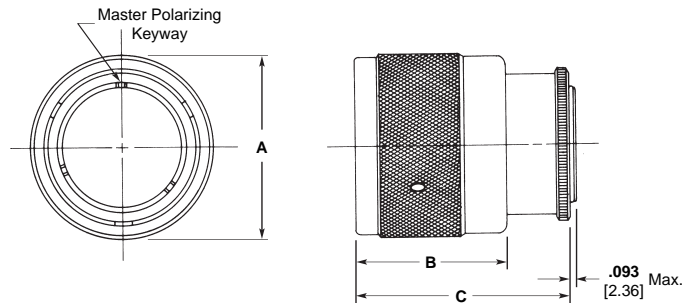

Shell Size	Dimensions		
	A	B (Max.)	C (Max.)
9	.813 20.65	1.000 25.4	1.288 32.72
12	1.000 25.40	1.000 25.4	1.288 32.72
15	1.125 28.58	1.000 25.4	1.288 32.72
18	1.594 40.49	1.000 25.4	1.288 32.72

Electronics

MARC 63 Series Connectors (Continued)

Configurations (Continued)

MD63-02E/RMD63-02E

Receptacle, Box Mounting, Environmental and Non-Environmental (Mates with Plug, Type 06)

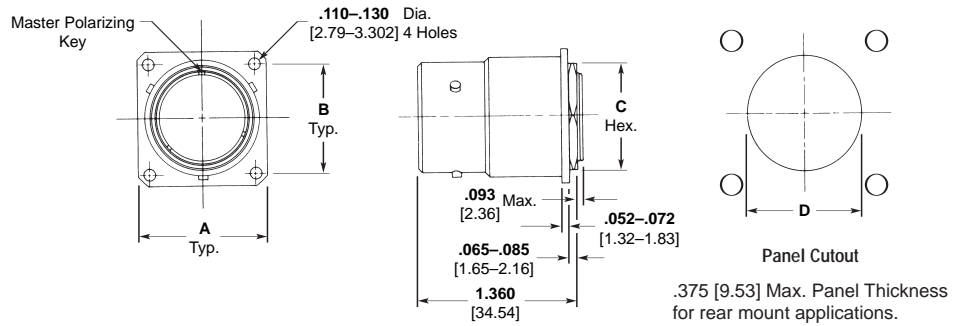

Shell Size	Dimensions			
	A	B	C	D
9	.875 22.23	.662 16.81	.562 14.27	.693-.697 17.60-17.70
12	1.000 25.40	.786 19.96	.75 19.05	.881-.885 22.38-22.48
15	1.125 28.58	.906 23.01	.875 22.23	1.006-1.011 25.55-25.68
18	1.344 34.14	1.062 26.97	1.125 28.58	1.250-1.260 30.48-32.00

MD63-00E/RMD63-00E

Receptacle, Single Hole Mounting, Environmental and Non-Environmental (Mates with Plug, Type 06)

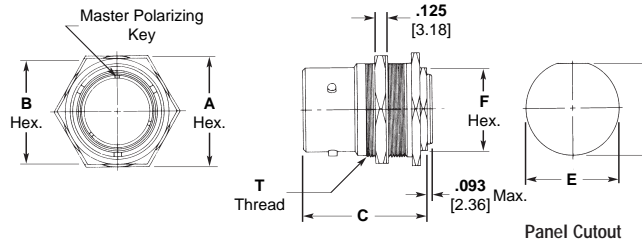

Shell Size	Dimensions						
	A	B	C	D	E	F	T (Class 2A)
9	.813 20.65	.75 19.05	1.360 34.54	.669-.673 16.99-17.09	.693-.697 17.60-17.70	.562 14.27	11/16-32UN
12	1.000 25.40	.937 23.80	1.360 34.54	.850-.856 21.59-21.74	.881-.885 22.38-22.48	.75 19.05	7/8-28UN
15	1.125 28.58	1.062 26.97	1.360 34.54	.975-.979 24.76-24.87	1.006-1.010 25.55-25.65	.875 22.23	1-28UN
18	1.625 41.28	1.375 34.93	1.360 34.54	1.212-1.216 30.78-30.88	1.251-1.255 31.78-31.88	1.125 28.58	1-1/4-28UN

MD63-01E/RMD63-01E

Receptacle, Line Cord, Environmental (Mates with Plug, Type 06)

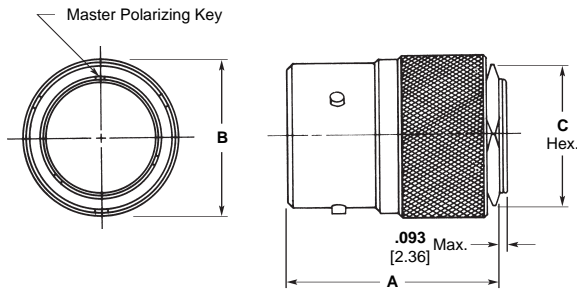

Shell Size	Dimensions		
	A	B (Max.)	C
9	1.360 34.54	.703 17.86	.562 14.27
12	1.360 34.54	.891 22.63	.75 19.05
15	1.360 34.54	1.016 25.81	.875 22.23
18	1.360 34.54	1.203 30.56	1.125 28.58

Accessories
Cable Clamps

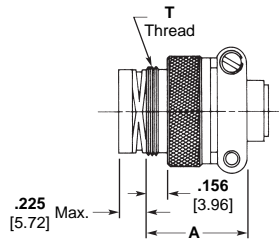

Straight

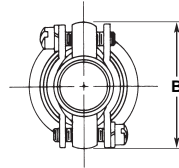

Shell Size	Part No.	A	B	T Thread
9	086-0175-00N1	.704 17.88	.750 19.05	1/2-20UNF-2A
12	086-0176-00N1	.773 19.63	.932 23.67	11/16-24UNEF-2A
15	086-0177-00N1	.829 21.06	1.078 27.38	13/16-20UNEF-2A
18	086-0178-00N1	.890 22.61	1.250 31.75	1-28UN-2A

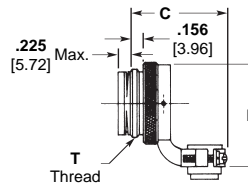

Angle

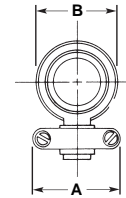

Shell Size	Part No.	A	B (Max.)	C (Max.)	D	T Thread
9	086-0179-00N1	.737 18.72	.600 15.24	1.100 27.94	.879 22.32	1/2-20UNF-2A
12	086-0180-00N1	.913 23.19	.785 19.94	1.250 31.75	1.067 27.10	11/16-24UNEF-2A
15	086-0181-00N1	1.048 26.62	.962 24.43	1.469 37.31	1.233 31.21	13/16-20UNEF-2A
18	086-0182-00N1	1.225 31.12	1.185 30.10	1.550 39.37	1.550 39.37	1-28UN-2A

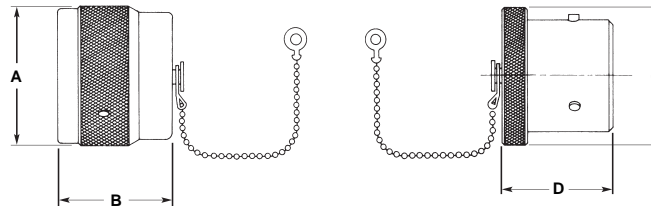

Protective Covers

Shell Size	Receptacle Part No.		Plug Part No.		Dimensions			
	Without Chain	With Chain	Without Chain	With Chain	A	B	C	D
9	086-0253-00P2	086-0257-00L6	086-0261-00F5	086-0265-00L6	.813 20.65	.950 24.13	.813 20.65	.913 23.19
12	086-0254-00P2	086-0258-00L6	086-0262-00F5	086-0266-00L6	1.000 25.40	.950 24.13	1.000 25.40	.913 23.19
15	086-0255-00P2	086-0259-00L6	086-0263-00F5	086-0267-00L6	1.125 28.58	.950 24.13	1.125 28.58	.913 23.19
18	086-0256-00P2	086-0260-00L6	086-0264-00F5	086-0268-00L6	1.594 40.49	.950 24.13	1.594 40.49	.913 23.19

Plastic Protective Covers also available; consult Tyco Electronics.

Modifications

We offer a unique modification system which provides alteration of standard MARC 63 Series Connectors to include special finishes, accessories, and custom

quality assurance provisions — processing, testing, serialization, traceability. Consult your sales representative or Tyco Electronics for additional modification information.

Standard modifications include:

(801): MARC 63 Series Connector, electroless nickel finish

(803): MARC 63 Series Connector including cable clamp, straight type

(804): MARC 63 Series Connector including cable clamp, right-angle type

MARC 43, MD53, MD63 Series

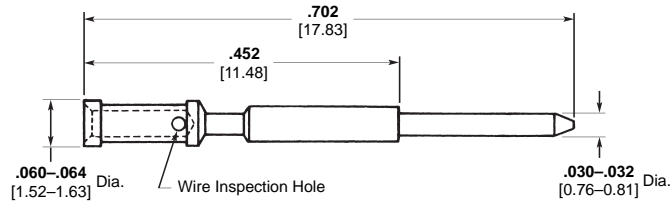

Part Number 083-0009-00R4
(6-1532030-1) 22 AWG Pin

MARC RMD53, RMD63 Series

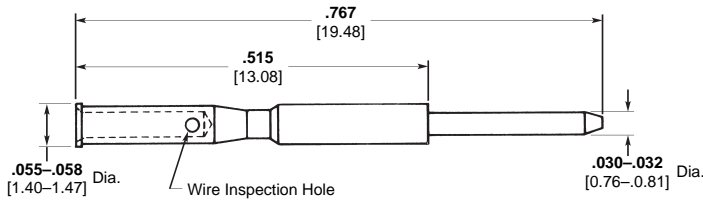

Part Number 083-1200-00R4
(4-1532036-8) 22 AWG Pin

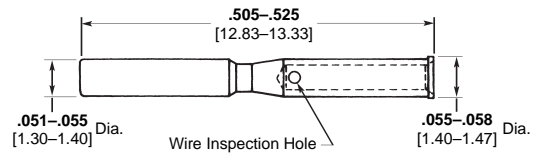

Part Number 082-0461-00Y9
(5-1532030-6) 22 AWG Socket

MARC 43, MD53, MD63 Series

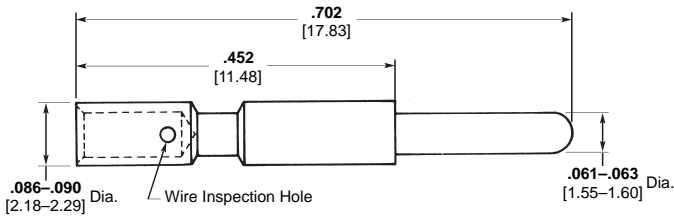

Part Number 083-0158-00R4
(8-1532030-1) 16 AWG Pin

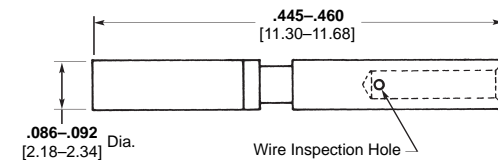

Part Number 082-0113-00T1
(3-1532030-3) 16 AWG Socket

MARC 43 Series

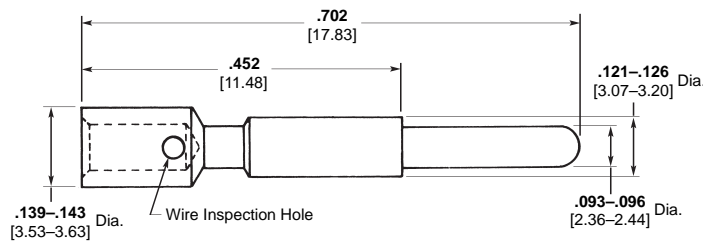

Part Number 083-0173-00R4
12 AWG Pin

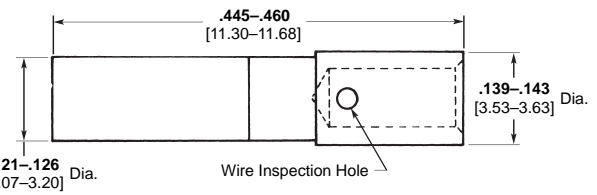

Part Number 082-0132-00T1
(3-1532030-4) 12 AWG Socket

MARC MD53, MD63 Series

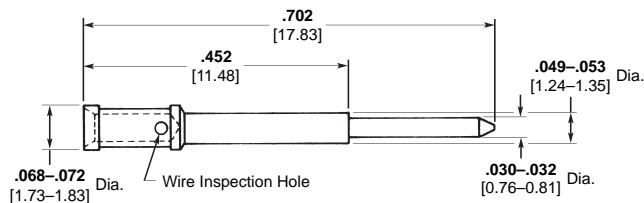

Part Number 083-1435-00R4
(7-1532037-3) 22-20 AWG Pin

MARC 43, MD53, MD63 Series

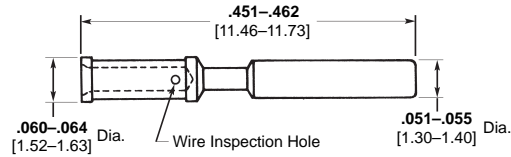

Part Number 082-0464-00Y9
(5-1532030-7) 22 AWG Socket

MARC MD53, MD63 Series

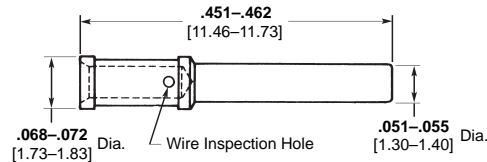

Part Number 082-0466-00Y9
22-20 AWG Socket

Coaxial Contacts

MARC 43, MD53, MD63 Series

Solder Type Coaxial Contacts

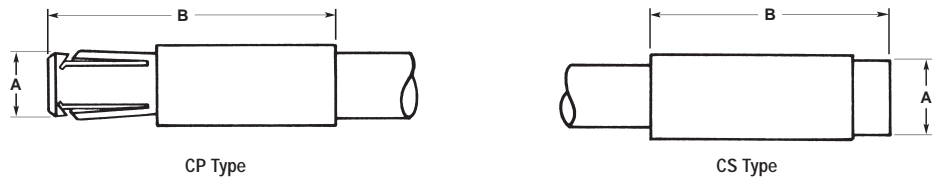

Contact	Part No.	Type	A Dia.	B
50 Ω	084-0027-00T2 (5-1532129-8)	CS	.109 2.77	.452 11.48
	084-0024-00T2 (5-1532129-7)	CP	.093 2.36	.600 15.24
75 Ω	084-0028-00T2 (5-1532129-9)	CS	.123 3.12	.452 11.48
	084-0025-00T2 (7-1532155-0)	CP	.106 2.69	.600 15.24
95 Ω	084-0029-00T2 (5-1532168-1)	CS	.168 4.27	.452 11.48
	084-0026-00T2	CP	.149 3.78	.600 15.24

MARC 43 Series

LEPRA/CON Crimp Type,
50 Ohm Coaxial Contacts

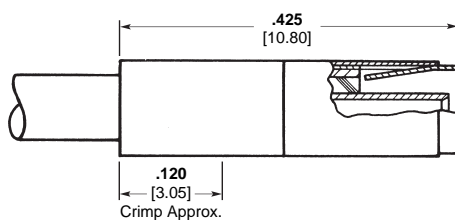

Part Number 142-1500-0001
CS Socket

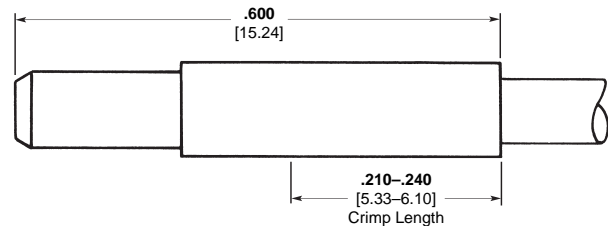

Part Number 141-1500-0001
CP Pin

Contact Cavity Sealing Plugs

Size	Part No.	Application	Description
	086-0001-0000	Unsealed 43 Series	
22 AWG	086-0009-0000	Sealed 43 Series MD53, RMD53 MD63, RMD63	
	086-0148-0000	RMD53, RMD63	
	086-0056-0000	Sealed 43 Series MD53, MD63	
16 AWG	086-0010-0000	Sealed 43 Series MD53, MD63	
	086-0014-0000	Unsealed 43 Series	
12 AWG	086-0057-0000	Sealed 43 Series	
	086-0015-0000	Unsealed 43 Series	
22/20 AWG	086-0251-0000	MD53, MD63	

Size	Part No.	Application	A Dia.	B Dia.	Description
5052	086-0061-0000	Unsealed 43 Series	.112-.120 2.84-3.05	—	
7552	086-0062-0000		.135-.143 3.43-3.63	—	
9552	086-0063-0000		.178-.186 4.52-4.72	—	
5052	086-0058-0000	Sealed 43 Series	.081-.089 2.06-2.26	.112-.120 2.84-3.05	
7552	086-0059-0000		.106-.114 2.69-2.90	.135-.143 3.43-3.63	
9552	086-0060-0000		.151-.159 3.84-4.04	.178-.186 4.52-4.72	

Assembly Tools

MARC 43, 53 and 63 Series Connectors

Removal Tool — None required.
Crimp Tools — Turret style tool (M22520/1-01 and TH88) MICRODOT Part Number 010-0080-0000 — Crimps all power contacts.
Locator Style Tool — MICRODOT Part Number 010-0070-0000 with locators.



Contact Size	Wire Size	Locator
22	22, 24	010-0072-0000
22	26	010-0087-0000
16	16, 18	010-0075-0000

For MARC 43 Series Connector Crimp Coax Contacts Use 010-0132-0000 & 010-0169-0000.

MARC 73 Series Connectors



Description	Part No.
Crimp Tool w/ Locator	010-3008-0000
Crimp Tool Only	010-3009-0000 M22520/2-01
Locator Only	010-3010-0000



Description	Part No.
Crimp Tool w/ Locator	010-3002-0000
Crimp Tool Only	010-0190-0000
Locator Only	010-3007-0000

Service and Performance Data

MARC 73 Series Connectors meet or exceed the performance requirements of specification MIL-C-38999. Your sales representative or field engineer can supply detailed, cross-reference information. MARC 73 Series Connectors meet the following selected test parameters as specified below:

DESCRIPTION	TEST REQUIREMENTS
Contact Retention	Contacts are to withstand 10 lbs [44.48 N] axial load without axial displacement in excess of 0.012 [0.30] or damage to contacts or inserts when the axial load is applied to the mating end of the contacts in unmated plugs and receptacles at a rate of approximately 1 lb/sec. [4.45 N].
Contact Resistance	The potential drop across normally mated contacts shall not exceed 25 mv under room ambient and high temperature service conditions when measured as specified in MIL C-39029 with maximum rated current.
Dielectric Withstanding Voltage, Altitude and Sea Level	No evidence of dielectric breakdown or flashover when mated and unmated plugs are subjected to 645 and 180 volts RMS, respectively, at altitudes up to 70,000 feet [21,336 m] and 1000 volts RMS at sea level.
Insulation Resistance, Room and High Temp.	Insulation resistance of mated plugs and receptacles shall be 5000 megohms, minimum, at room temperature and 1000 megohms, minimum, at 257°F [+125°C] when measured per MIL-STD 202, Method 302, Test Condition B.
Coupling and Uncoupling	Plugs and receptacles shall withstand up to 500 cycles of engagement and separation without detrimental damage to plugs or receptacles or not satisfying subsequent tests.
Fluid Immersion	Mating and unmating forces shall not exceed 27 lbs [120.10 N] maximum, (15 shell size) after fully wired plugs and receptacles are immersed for 20 hours, each, in hydraulic fluid (MIL-H-5606) and high temperature lubricating oil (MIL-L-9236) followed by a one-hour dry.
Sweep Vibration, Mated	Mated connectors shall show no circuit interruptions greater than one microsecond during 12 hours vibration to include six sweeps in each axis at extreme temperatures of -85°F [-65°C] and 257°F [+125°C] per MIL-STD-202, Method 204, Test Condition D. Post inspection shall show no detrimental cracking, breaking, or loosening of parts.
Moisture Resistance	The insulation resistance of mated connectors shall exceed 1000 megohms after subjection to moisture resistance testing per MIL-STD-202, Method 106.
Altitude Breathing	The insulation resistance of wired and mated connectors shall be 5000 megohms, minimum, and there shall be no flashover or breakdown at test voltage of 1000 volts RMS after the third cycle and while immersed in 5% salt water solution at 68°F [20°C] and room ambient pressure at 68°F [20°C].
Salt Spray	Unmated plugs and receptacles shall show no excessive corrosion which would detrimentally affect the electrical and mechanical performance of the connectors after subjection to 24 hours exposure to salt spray atmosphere per MIL-STD-202, Method 101.

Service and Performance Data

I. Electrical — Electrical Ratings

Contact Size	Current Rating (Amperes, Max., 81°F [+27°C])	Dielectric Withstanding Voltage (RMS)	Working Voltage		Contact Resistance (Millivolts, Max.)
			Sea Level	110,000 Ft. Alt. ¹	
22 AWG	5	1000	750	300	8

¹ 110,000 ft = 33,528 m

Wire Range Accommodations

Wire Barrel Size	Wire Size (AWG)	O.D. of Finished Wire Range		Wire Spec. MIL-W-16878
22 AWG	26	.029 Min.	.031 Max.	Type "E" or "ET"
	24	—	.036 Nom.	Type "ET"
	22	.044 Max.	.042 Nom.	Type "ET"

II. Mechanical — Durability: 500 Cycles Mate/Unmate. Coupling/Uncoupling Forces and Tightening Torques:

Shell Size	Coupling/Uncoupling Force (In-Lbs.) Max.	Tightening Torque (In-Lbs.)	
		Retaining Nut	Mounting Nut
9	10 [44.48]	20 [2.26 N] Max.	30-45 [3.39 Nm – 5.08 Nm]
12	15 [66.72]	20 [2.26 N] Max.	40-55 [4.52 Nm – 6.21 Nm]
15	22 [97.86]	20 [2.26 N] Max.	55-70 [6.21 Nm – 7.91 Nm]
18	28 [124.55]	20 [2.26 N] Max.	70-85 [7.91 Nm – 9.60 Nm]

Operating Temperature: -67°F to 257°F [-55°C to +125°C].
Connector Mated Length: 2.217 [56.31] Max.

Part Number and Ordering Information

MARC 73 Series Connector part numbers indicate size, shape, insert layout, type of seal, style of contact and polarization.

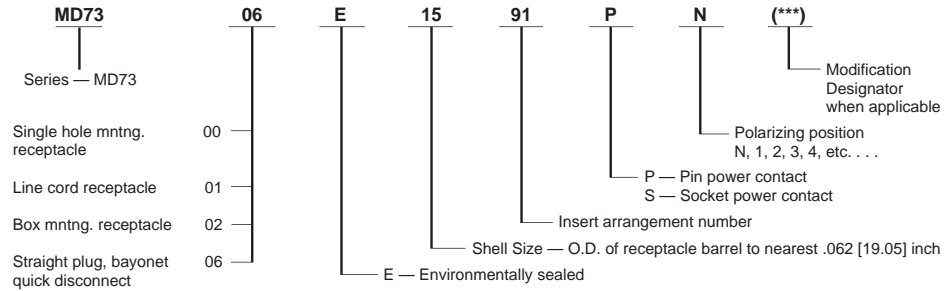

Notes: Pin contacts in plug; socket contacts in receptacle.
If P or S does not appear in the numbering system, no contacts will be supplied with order (order separately).

Contact Arrangements¹

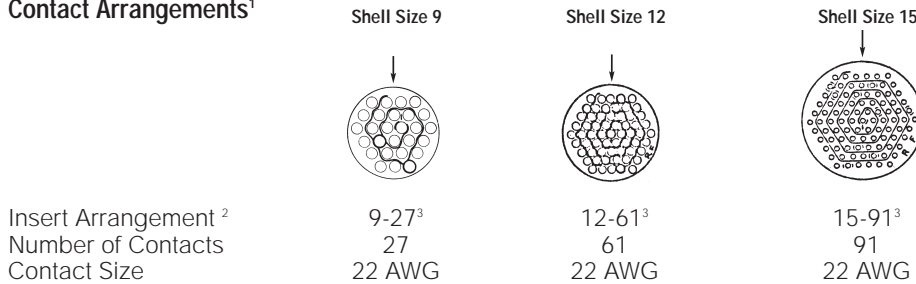

¹ Views shown are front face views of receptacles. Front face view of plug is mirror image of that shown.
² Arrow (†) indicates insert top or vertical position in relation to top or vertical position of housing.
³ The 22 AWG contact arrangements will accommodate MIL-W-16878 Type ET, 22, 24, 26 AWG wire. Contact spacing is on 0.065 [1.65] centers.

MARC 73 Series Connectors (Continued)

Configurations

MD73-06E

Straight Plug, Bayonet Coupling, Environmental and Non-Environmental (Mates with Receptacles 02, 00 and 01)

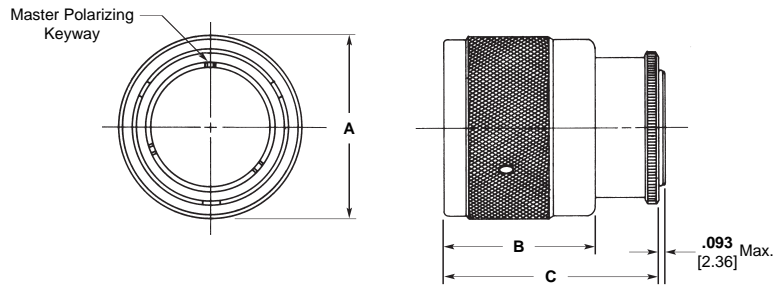

Shell Size	Dimensions		
	A	B (Max.)	C (Max.)
9	.813 20.65	1.000 25.40	1.288 32.72
12	1.000 25.40	1.000 25.40	1.288 32.72
15	1.125 28.58	1.000 25.40	1.288 32.72
18	1.594 40.49	1.000 25.40	1.288 32.72

MD73-02E

Receptacle, Box Mounting, Environmental and Non-Environmental (Mates with Plug, Type 06)

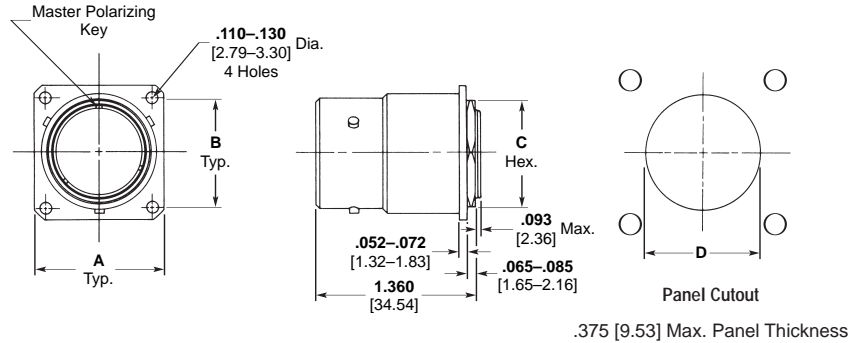

Shell Size	Dimensions			
	A	B	C	D
9	.875 22.23	.662 16.81	.562 14.27	.693-.697 17.60-17.70
12	1.000 25.40	.786 19.96	.75 19.05	.881-.885 22.38-22.48
15	1.125 28.58	.906 23.01	.875 22.23	1.006-1.011 25.55-25.68
18	1.344 34.14	1.062 26.97	1.125 28.58	1.250-1.260 31.75-32.00

MD73-00E

Receptacle, Single Hole Mounting, Environmental and Non-Environmental (Mates with Plug, Type 06)

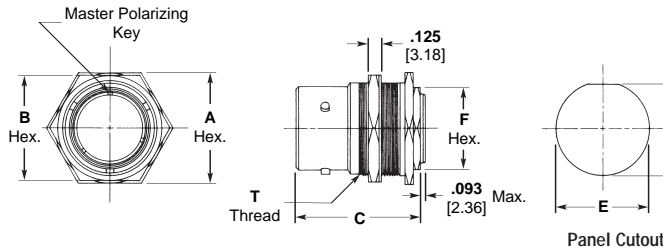

Shell Size	Dimensions						
	A	B	C	D	E	F	T (Class 2A)
9	.813 20.65	.75 19.05	1.360 34.54	.669-.673 16.99-17.09	.693-.697 17.60-17.70	.562 14.27	11/16-32UN
12	1.000 25.40	.937 23.80	1.360 34.54	.850-.856 21.59-21.74	.881-.885 22.38-22.48	.75 19.05	7/8-28UN
15	1.125 28.58	1.062 26.97	1.360 34.54	.975-.979 24.77-24.87	1.006-1.010 25.55-25.65	.875 22.23	1-28UN
18	1.625 41.28	1.375 34.93	1.360 34.54	1.212-1.216 30.78-30.89	1.251-1.255 31.78-31.88	1.125 28.58	1-1/4-28UN

Electronics

MARC 73 Series Connectors (Continued)

Configurations (Continued)

MD73-01E

Receptacle, Line Cord,
Environmental (Mates with
Plug, Type 06)

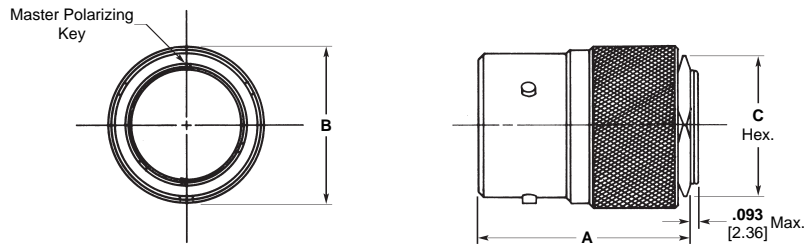

Shell Size	Dimensions		
	A	B (Max.)	C
9	1.360	.703	.562
	34.54	17.86	14.27
12	1.360	.891	.75
	34.54	20.57	19.05
15	1.360	1.016	.875
	34.54	25.81	22.23
18	1.360	1.203	1.125
	34.54	30.56	28.58

Accessories
Cable Clamps

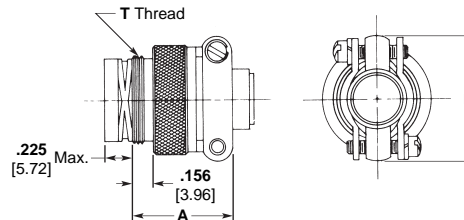

Shell Size	Clamp Part No.	A	B	T Thd. 2A
9	086-0341-00N1	.704 17.88	.750 19.05	1/2-20 UNF
12	086-0342-00N1	.773 19.63	.932 23.67	11/16-24 UNEF
15	086-0343-00N1	.829 21.06	1.078 27.38	13/16-20 UNEF
18	086-0344-00N1	.890 22.61	1.250 31.75	1-28 UN

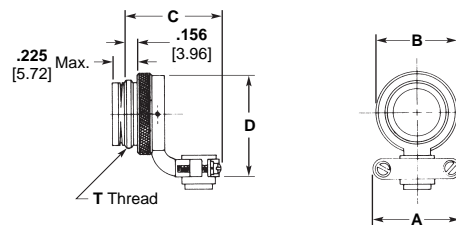

Shell Size	Clamp Part No.	A	B (Max.)	C (Max.)	D	T Thd. 2A
9	086-0337-00N1	.737	.600	1.100	.879	1/2-20 UNF
		18.72	15.24	27.94	22.33	
12	086-0338-00N1	.913	.785	1.250	1.067	11/16-24 UNEF
		23.19	19.94	31.75	27.10	
15	086-0339-00N1	1.048	.962	1.469	1.233	13/16-20 UNEF
		26.62	24.43	37.31	31.32	
18	086-0340-00N1	1.225	1.185	1.550	1.550	1-28 UN
		31.12	30.10	39.37	39.37	

Accessories (Continued)

Contacts

Twist pin — 22 Pins and Sockets

Copper alloy plated .000050 [0.00127]
gold over copper flash per MIL-G-45204,
Type II

Rating — 5 amps

Contact Resistance — .008 ohms
max.

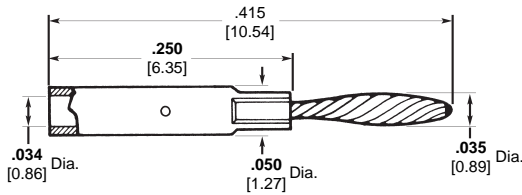

Part Number 096-0526-0000

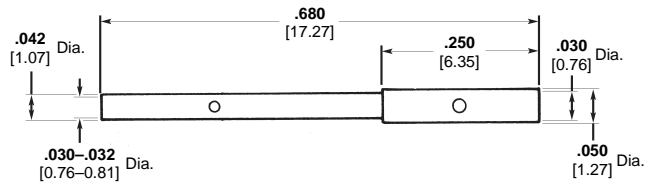

Part Number 096-0626-0001

Engineering/Separation Forces —
6 oz. [1.67 N] max. / .502 [1.139 N] min.

Durability — 2000 cycles

Contact Cavity Sealing Plugs

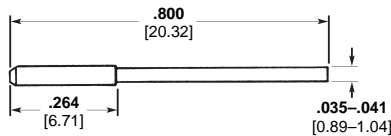

Part Number 086-0331-0000

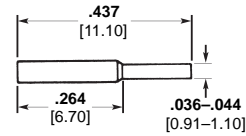

Part Number 086-0330-0000

Contact Size	Sealing Plug	Filler Plug
22 AWG	086-0331-0000	086-0330-0000

Note: Sealing plug occupies insert and grommet cavities.
Filler plug occupies insert cavity only.

MQR Series — Microminiature Circular Connectors



MQR stands for MICRODOT Quick Release. This line of circular quick disconnect connectors has metal shells with push-pull couplings which provide a positive connection for rugged environmental use. The MQR series is specified for cable-to-cable and cable-to-panel applications.

The plug connector side contains socket contacts. The receptacle connector side contains pin contacts. Because the pin contact is

“active” or “live”, the pins require the physical protection that the receptacle side offers. (Similar to a “protected” or “shrouded” header.)

While there is no optional hardware for the MQR series, the receptacles incorporate a standard jam nut to tighten the connector down to the board or panel.

MQR connectors are manufactured to the performance specifications of MIL-DTL-83513.

How to Specify/ Ordering Code

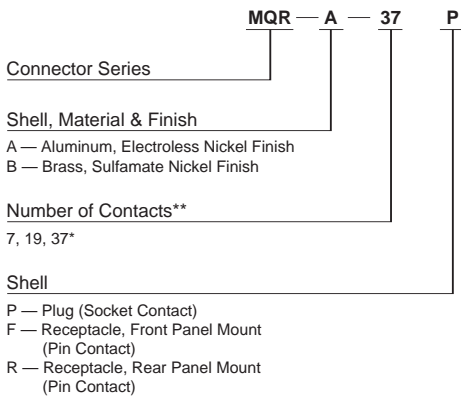

*uses twist pin contacts
 ** Other non-standard sizes are also available, contact Tyco Electronics for details.

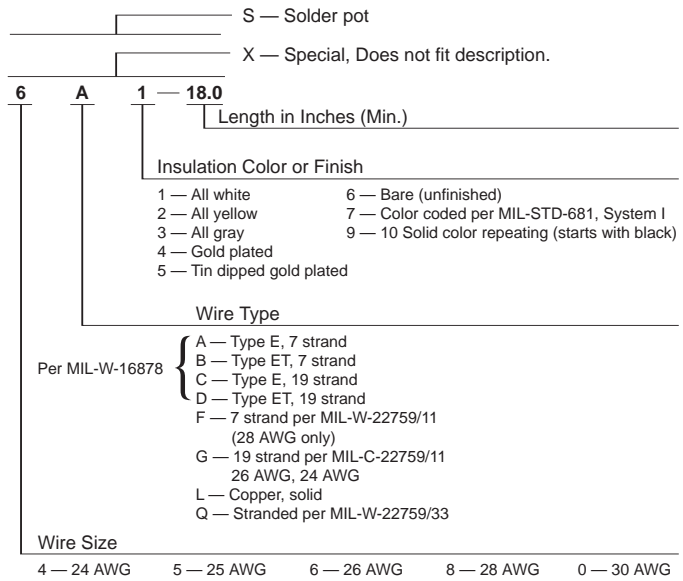

Front Panel Mount (MQR Receptacle)

Size	Dimensions			
	A (Hex)	B (Min.)	Ø C (Min.)	D Thd.
7	.500 12.7	.361 9.17	.376 9.55	3/8-32 UNEF-2A
19	.625 15.88	.477 12.16	.501 12.73	1/2-28 UNEF-2A
37	.812 20.62	.722 18.39	.751 19.07	3/4-20 UNEF-2A

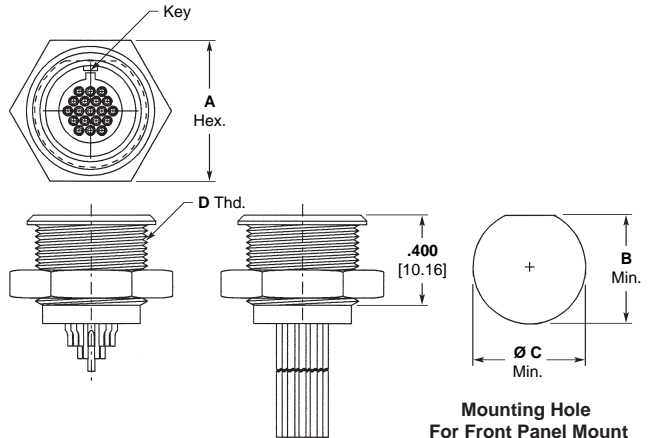

Front Panel Mount (19 Position Shown)

Rear Panel Mount (MQR Receptacle)

Size	Dimensions			
	A (Hex)	B (Min.)	Ø C (Min.)	D Thd.
7	.500 12.7	.422 10.72	.440 11.18	7/16-28 UNEF-2A
19	.687 17.45	.531 13.49	.564 14.33	9/16-24 UNEF-2A
37	.812 20.62	.722 18.39	.751 19.07	3/4-20 UNEF-2A

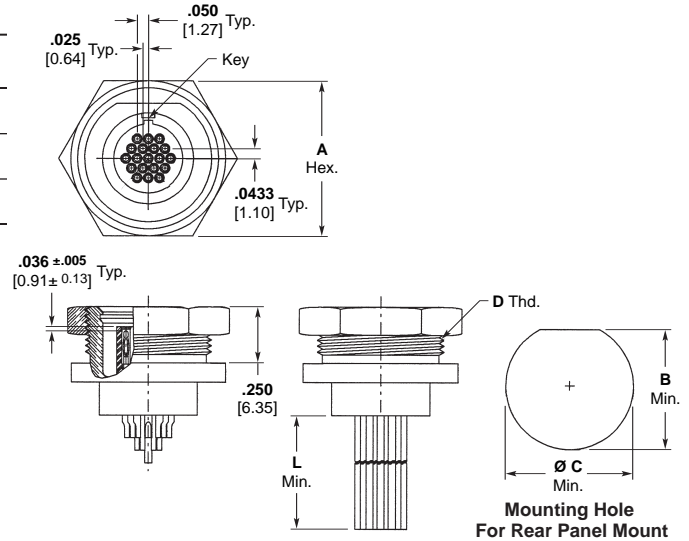

Rear Panel Mount (19 Position Shown)

Circular MQR Series Quick Release Receptacle

7 Position (Stamped Pin)

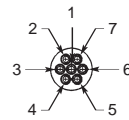

19 Position (Stamped Pin)

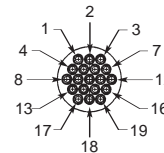

37 Position (Twist Pin)

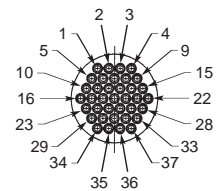

Circular MQR Series Quick Release Plug

MQR Plug

Size	Dimensions	
	Ø A	Ø B
7	.375 9.53	.300 7.62
19	.475 12.07	.400 10.16
37	.750 19.05	.630 16.00

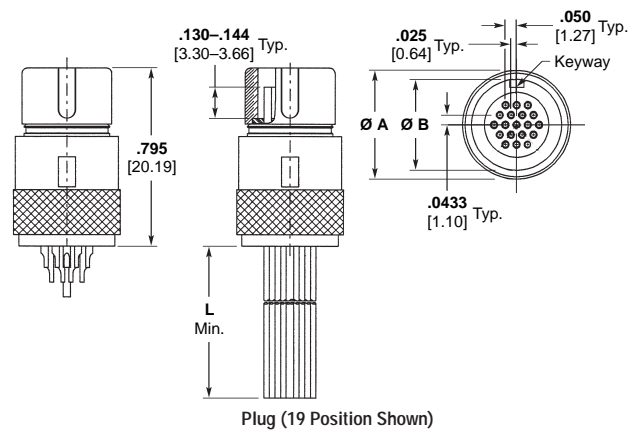

Plug (19 Position Shown)

7 Position

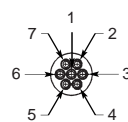

19 Position

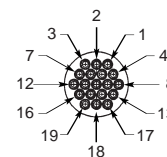

37 Position

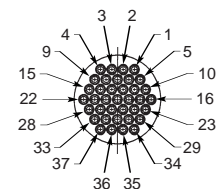

**How to Specify/
Ordering Code**

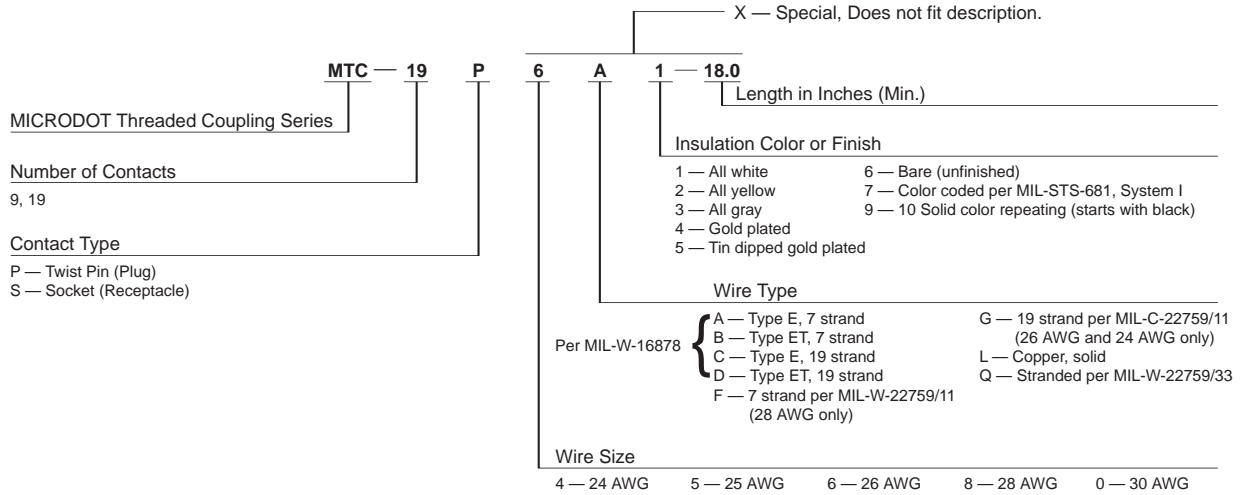

Material and Finish

Shell — Aluminum, nickel plated
 Contact — Copper alloy, gold plated
 Insulator — RYTON

MTC Series Plug

Size	Dimensions		
	Ø A	Ø B	C Thd.
9	.227	.456	M10 x 0.75
	5.77	11.58	19.05
19	.308	.545	M12 x 1
	7.82	13.84	25.40

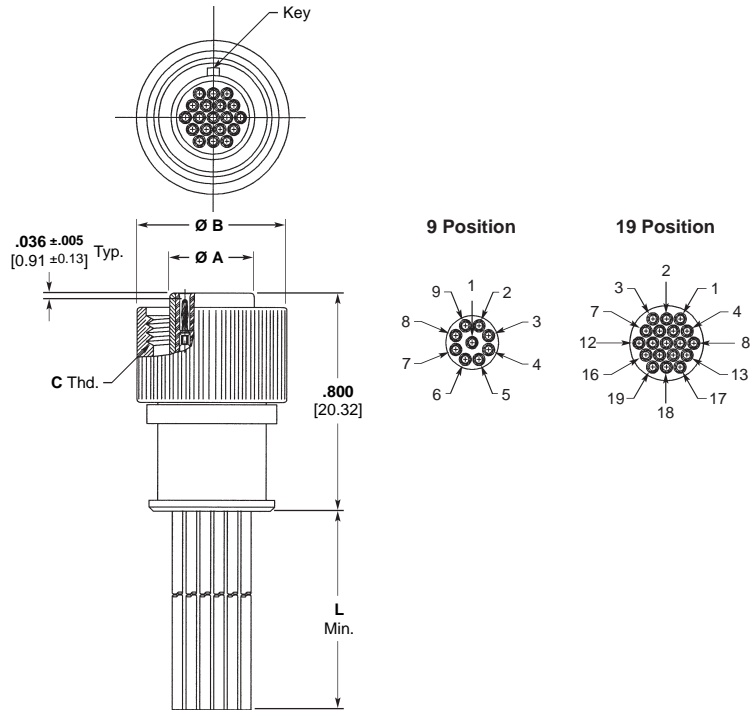

MTC Series Plug (19 Position Shown)

MTC Series — Microminiature Circular Connectors (Continued)

MTC Series Receptacle

Size	Dimensions				
	Ø A	B Hex.	C Thd.	D Min.	Ø E Min.
9	.562	.500	M10 x 0.75	.370	.394
	14.27	12.70	19.05	9.40	10.01
19	.625	.625	M12 x 1	.445	.474
	15.88	15.88	25.40	11.30	12.04

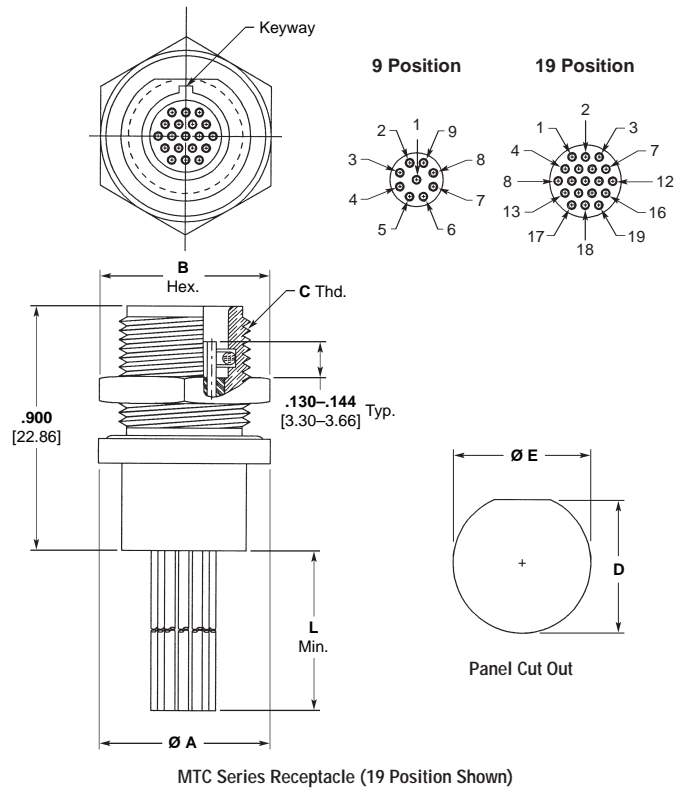

Introduction

Product Facts

- Designed to accept 50, 70 and 93 ohm miniature coaxial cables
- Three types of connectors: Screw-on Series, Slide-on Series and Quick-Connect Series
- Temperature range —
-85°F to +257°F [-65°C to +125°C] (with neoprene gasket or bend relief cap)
-80°F to 392°F [-62°C to +200°C] (with silicone gasket or bend relief cap)
- Dielectric Withstanding Voltage — 1000 volts RMS at sea level
- Contact Resistance — 3 milliohms max., D.C.
- Captive Contacts — Terminated connector contacts captivated from movement in both directions



MICRODOT Standard Coaxial Connectors are designed to accept 50, 70, and 93 Ohm miniature coaxial cables. These connectors are available as Screw-On Series, Slide-On Series, or Quick-Connect Series. The Screw-On Series is interchangeable with

the Gold Plated Crimp Style Coaxial Connector Series and offers the dependability of a threaded coupling. For enhanced safety, choose connectors with wire holes. Choose Slide-On Series for the fastest, most convenient mating and unmating.

The Quick-Connect Series offers the convenience of Slide-On coupling with added retention provided by a snap ring located on the jack/receptacle side. Consult Tyco Electronics for special cable accommodations and mounting features.

Performance Data Summary For Standard Connectors

Standard Connectors

Mechanical

Captive Contacts — Terminated connector contacts captivated from movement in both directions.

Cable Retention —
50 Ohm connectors, 15 lb. min.¹
70 Ohm connectors, 25 lb. min.¹
93 Ohm connectors, 35 lb. min.¹

Recommended Coupling Torque (Threaded Interface) —
8 inch/pounds max.

Recommended Receptacle Mounting Torque (All Series) —
8 inch/pounds max.

Unmating Force (Slide-On Series) —
1-7 pounds.

Contact Protection (Unmated) —
Pin contact protected by coupling nut (threaded series)² or by housing (Quick-Connect and Slide-On Series). Socket protected by insulator and housing.

Assembly Methods

Straight Plugs & Jacks — Cable Inner Conductor: Soldered to contact. Cable Shield: Crimped to jerk ring (solder optional).

Angle Plugs — Cable Inner Conductor: Soldered to contact. Cable Shield: Soldered to ring & housing.

Environmental

Temperature Range (Continuous Service) — -85°F to +257°F [-65°C to +125°C] (with Neoprene gasket or bend relief cap). -80°F to 392°F [-62°C to +200°C] (with Silicone gasket or bend relief cap).

Vibration^{3,4} — MIL-STD-202, Method 204, Test condition B (15 G peak). No physical damage or electrical discontinuities in excess of 1 microsecond.

Shock^{3,4} — MIL-STD-202, Method 213, Test Condition H. No physical damage or electrical discontinuity after shock.

Thermal Shock — MIL-STD-202, Method 107, Test Condition B.

Moisture Resistance³ — MIL-STD-202, Method 106.

Salt Spray³ — MIL-STD-202, Method 101, Test Condition B (48 hours).

Electrical

Impedance — Designed to be compatible with 50, 70, or 93 Ohm miniature coaxial cable.

Dielectric Withstanding Voltage — 1000 volts RMS at sea level.

Contact Resistance — 3 milliohms max., D.C.

Current Capacity — 3 amps, D.C.

Insulation Resistance — 5×10^3 Megohms min. @ 500 volts D.C.

Voltage Standing Wave Ratio⁵ (VSWR) — Typical 50 Ohm series, 1.2 max. to 2 GHz.

Materials

Housing, Nut, Jerk Ring — Brass per ASTM-B-16.

Insulator — TEFLON per ASTM-D-1710.

Pin Contact (Plugs) — Brass per ASTM-B-16.

Socket Contact (Jacks & Receptacles) — Beryllium Copper per ASTM-B-196.

Bend Relief Caps (Plugs & Jacks) — Neoprene or Silicone Rubber per ZZ-R-765.

Gaskets (Jacks & Receptacles) — Neoprene or Silicone Rubber per ZZ-R-765.

Lockwasher — #425 Bronze Alloy.

Plating

Contacts — Gold per MIL-G-45204, Type II, Grade C, Class 1.

Housing, Nut, Jerk Ring, Lockwasher — Silver per QQ-S-365, Type II, Grade A, .0002 [.005] min.

Notes:

¹Termination to cables with foamed dielectrics excluded. Straight connector jerk rings must be soldered to cable shield.

²Pin protector required. See individual connector specifications.

³Screw-On Series, threaded interface.

⁴Tyco Electronics recommends the use of safety wired connectors in vibration and shock environment.

See individual specifications for connectors with safety wire holes.

⁵VSWR is a system specification. Where performance is critical, purchase Tyco Electronics cable assemblies with Screw-On or Quick-Connect Series connectors and specify VSWR testing and mating connector part number.

See page 128 for mating options.



Plug

S-50 Ohm Series	S-70 Ohm Series	S-93 Ohm Series
032-0021-0001	032-0010-0001	032-0011-0001
032-0023-0001	032-0022-0001	032-0017-0001
032-0025-0001	032-0067-0001	032-0066-0001
032-0033-0001	032-0078-0001	032-0071-0001
032-0097-0001	032-0222-0001	032-0092-0001
032-0098-0001	052-0092-0001	032-0099-0001
032-0155-0001		052-0200-0001
032-0156-0001		
052-0213-0001		
052-0235-0001		
052-0235-0003		
052-0370-0001		
052-0542-0001		

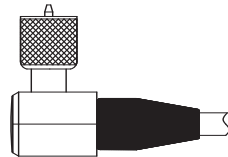

Right-Angle Plug

S-50 Ohm Series	S-70 Ohm Series	S-93 Ohm Series
032-0015-0001	032-0013-0001	032-0014-0001
052-0204-0001	052-0299-0001	032-0068-0001
052-0215-0001	052-0379-0001	032-0153-0001
052-0337-0001		052-0207-0001
		052-0298-0001
		052-0304-0022

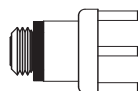

Printed Circuit Receptacle

S-50 Ohm Series	S-70 Ohm Series	S-93 Ohm Series
031-0059-0001	031-0069-0001	031-0067-0001
031-0062-0001		031-0080-0001
051-0450-0001		



Jack

S-50 Ohm Series	S-70 Ohm Series	S-93 Ohm Series
031-0034-0001	031-0036-0001	031-0037-0001
051-0467-0001	031-0090-0001	031-0088-0001

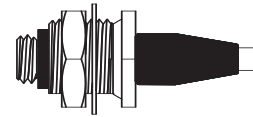

Bulkhead Jack

S-50 Ohm Series	S-70 Ohm Series	S-93 Ohm Series
031-0033-0001	031-0048-0001	031-0032-0001
		031-0089-0001

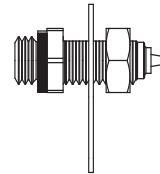

Receptacle

S-50 Ohm Series	S-70 Ohm Series	S-93 Ohm Series
031-0050-0001	031-0051-0001	031-0052-0001
051-0318-0001		

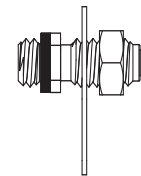

Receptacle

S-50 Ohm Series	S-70 Ohm Series	S-93 Ohm Series
031-0001-0001	031-0017-0001	031-0016-0001
031-0001-0003	031-0018-0001	031-0019-0001
031-0002-0001		031-0046-0001
031-0003-0001		
031-0024-0001		
051-0125-0001		

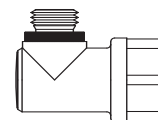

Right-Angle Printed Circuit Receptacle

S-50 Ohm Series	S-70 Ohm Series	S-93 Ohm Series
031-0061-0001	031-0072-0001	031-0073-0001
051-0459-0001		

Plugs

S-50, 70 & 93

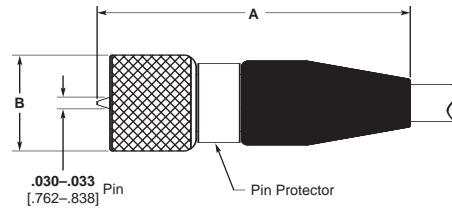

Part No.	Dim. A	Dim. B	Cable Jacket Max.	Special Features	Instruction Sheet No.	Former MICRODOT I.S. No.	Assembly Tool
S-50 Series (50 Ohm) .190 [4.83] -32 UNF-2B Thread							
032-0021-0001	.745 18.92	.230 5.84	Dia.	.087 2.21	'Solderless Assembly	408-08521	RF-ASMB-88 010-0003-0000
032-0023-0001	.745 18.92	.230 5.84	Dia.	.087 2.21	¹	408-08522	RF-ASMB-89 010-0003-0000
032-0025-0001	.745 18.92	.230 5.84	Dia.	.093 2.36	'Solderless Assembly	408-08521	RF-ASMB-88 010-0003-0000
032-0033-0001	.745 18.92	.230 5.84	Dia.	.093 2.36	¹	408-08522	RF-ASMB-89 010-0003-0000
032-0097-0001	.745 18.92	.250 6.35	Hex.	.087 2.21	'Solderless Assembly, Hex Nut	408-08521	RF-ASMB-88 010-0003-0000
032-0098-0001	.745 18.92	.250 6.35	Hex.	.087 2.21	Hex Nut	408-08522	RF-ASMB-89 010-0003-0000
032-0155-0001	.700 17.78	.250 6.35	Hex.	.088 2.24	^{1,2} Hex Nut, .187 [4.75] Hex Cable Clamp Nut	408-08522	RF-ASMB-89 010-0003-0000
032-0156-0001	.700 17.78	.250 6.35	Dia.	.088 2.24	^{1,2} .187 [4.75] Hex Cable Clamp Nut	408-08522	RF-ASMB-89 010-0003-0000
052-0213-0001	.745 18.92	.250 6.35	Hex.	.087 2.21	'Solderless, Hex Nut w/ Safety Wire Holes, .021 [0.53] Wire Max.	408-08521	RF-ASMB-88 010-0003-0000
052-0235-0001	.745 18.92	.250 6.35	Hex.	.087 2.21	^{1,2} Hex Nut	408-08522	RF-ASMB-89 010-0003-0000
052-0235-0003	.745 18.92	.250 6.35	Hex.	.087 2.21	^{1,2} Hex Nut w/ Safety Wire Holes, .021 [0.53] Wire Max.	408-08522	RF-ASMB-89 010-0003-0000
052-0370-0001	.745 18.92	.250 6.35	Hex.	.093 2.36	'Hex Nut, Designed for Dual Shield Cable	408-08522	RF-ASMB-89 010-0003-0000
052-0542-0001	.745 18.92	.250 6.35	Hex.	.087 2.21	'Hex Nut	408-08522	RF-ASMB-89 010-0003-0000
S-70 Series (70 Ohm) .216 [5.49] -32 UNEF-2B Thread							
032-0010-0001	.760 19.30	.255 6.48	Dia.	.093 2.36	'Solderless Assembly	408-08521	RF-ASMB-88 010-0004-0000
032-0022-0001	.760 19.30	.255 6.48	Dia.	.093 2.36	¹	408-08525	RF-ASMB-95 010-0004-0000
032-0067-0001	.755 19.18	.255 6.48	Dia.	.108 2.74	¹	408-08522	RF-ASMB-89 010-0035-0000
032-0078-0001	.755 19.18	.255 6.48	Dia.	.108 2.74	'Solderless Assembly	408-08521	RF-ASMB-88 010-0035-0000
032-0222-0001	.760 19.30	.281 7.14	Hex.	.093 2.36	'Hex Nut w/ Safety Wire Holes, .014 [0.35] Wire Max.	408-08525	RF-ASMB-95 010-0004-0000
052-0092-0001	.760 19.30	.255 6.48	Dia.	.093 2.36	²	408-08525	RF-ASMB-95 010-0004-0000
S-93 Series (93 Ohm) .250 [6.35] -32 UNEF-2B Thread							
032-0011-0001	.760 19.30	.320 8.13	Dia.	.134 3.40	'Solderless Assembly	408-08521	RF-ASMB-88 010-0005-0000
032-0017-0001	.760 19.30	.320 8.13	Dia.	.134 3.40	¹	408-08525	RF-ASMB-95 010-0005-0000
032-0066-0001	.950 24.13	.350 8.89	Dia.	.154 3.91	'Silicone Bend Relief Cap	408-08523	RF-ASMB-90 —
032-0071-0001	.760 19.30	.320 8.13	Dia.	.134 3.40	'Cable Inner Conductor, .031 [0.78] Max.	408-08525	RF-ASMB-95 010-0005-0000
032-0092-0001	.760 19.30	.320 8.13	Dia.	.155 3.94	¹	408-08525	RF-ASMB-95 010-0044-0000
032-0099-0001	.760 19.30	.312 7.92	Hex.	.134 3.40	'Hex Nut	408-08525	RF-ASMB-95 010-0005-0000
052-0200-0001	.760 19.30	.312 7.92	Hex.	.134 3.40	'Hex Nut w/ Safety Wire Holes, .015 [0.38] Wire Max.	408-08525	RF-ASMB-95 010-0005-0000

¹Pin protected.

²Hole in ferrule permits soldering to clamp ring and shield for increased cable pullout strength.

Standard Connectors — Screw-On Series (Continued)

Right-Angle Plugs
S-50, 70 & 93

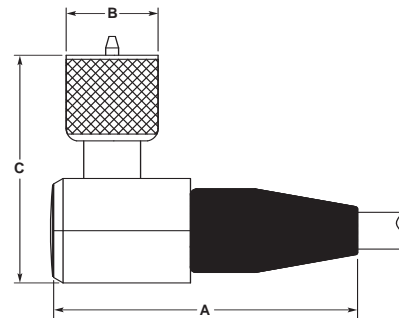

Part No.	Dim. A	Dim. B	Dim. C	Cable Jacket Max.	Special Features	Instruction Sheet No.	Former MICRODOT I.S. No.	Assembly Tool
S-50 Series (50 Ohm) .190 [4.83] -32 UNF-2B Thread								
032-0015-0001	.735 18.67	.225 5.72	Dia.	.570 14.48	.092 2.34		RF-ASMB-87	010-0016-0000
052-0204-0001	.735 18.67	.250 6.35	Hex.	.570 14.48	.092 2.34	Hex Nut	RF-ASMB-87	010-0016-0000
052-0215-0001	.735 18.67	.250 6.35	Hex.	.570 14.48	.092 2.34	Hex Nut w/ Safety Wire Holes, .021 [.533] Wire Max.	RF-ASMB-87	010-0016-0000
052-0337-0001	.745 18.92	.225 5.72	Dia.	.570 14.48	.111 2.82	Dual Shield Cable	RF-ASMB-87	010-0016-0000
S-70 Series (70 Ohm) .216 [5.49] -32 UNEF-2B Thread								
032-0013-0001	.745 18.92	.255 6.48	Dia.	.570 14.48	.111 2.82		RF-ASMB-87	010-0016-0000
052-0299-0001	.745 18.92	.281 7.14	Hex.	.570 14.48	.111 2.82	Hex Nut w/ Safety Wire Holes, .014 [.355] Wire Max.	RF-ASMB-87	010-0016-0000
052-0379-0001	.745 18.92	.281 7.14	Hex.	.570 14.48	.111 2.82	Hex Nut	RF-ASMB-87	010-0016-0000
S-93 Series (93 Ohm) .250 [6.35] -32 UNEF-2B Thread								
032-0014-0001	.745 18.92	.320 8.13	Dia.	.630 16.00	.134 3.40		RF-ASMB-87	010-0017-0000
032-0068-0001	.745 18.92	.320 8.13	Dia.	.630 16.00	.155 3.94		RF-ASMB-87	010-0017-0000
032-0153-0001	.745 18.92	.312 7.92	Hex.	.630 16.00	.155 3.94	Hex Nut	RF-ASMB-87	010-0017-0000
052-0207-0001	.745 18.92	.312 7.92	Hex.	.630 16.00	.134 3.40	Hex Nut	RF-ASMB-87	010-0017-0000
052-0298-0001	.745 18.92	.312 7.92	Hex.	.630 16.00	.134 3.40	Hex Nut w/ Safety Wire Holes, .015 [.381] Wire Max.	RF-ASMB-87	010-0017-0000
052-0304-0022	.745 18.92	.312 7.92	Hex.	.630 16.00	.155 3.94	Hex Nut w/ Safety Wire Holes, .015 [.381] Wire Max., Silicone Bend Relief Cap	RF-ASMB-87	010-0017-0000

Jacks

S-50, 70 & 93

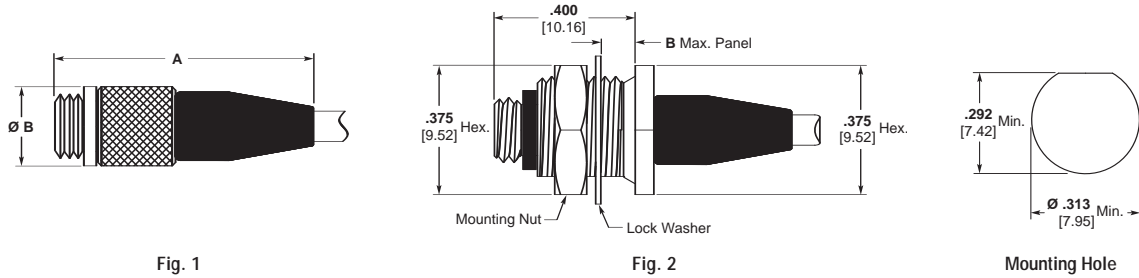

Part No.	Fig.	Dim. A	Dim. B	Cable Jacket Max.	Special Features	Instruction Sheet No.	Former MICRODOT I.S. No.	Assembly Tool
S-50 Series (50 Ohm) .190 [4.83] -32 UNF-2A Thread								
031-0033-0001	2	.870 22.10	.140 3.56	.088 2.24		408-08522	RF-ASMB-89	010-0003-0000
031-0034-0001	1	.750 19.05	.235 5.97	.087 2.21		408-08522	RF-ASMB-89	010-0003-0000
051-0467-0001	1	.720 18.30	.235 5.97	.079 2.01	Hex Collet Cable Clamp	408-08522	RF-ASMB-89	010-0003-0000
S-70 Series (70 Ohm) .216 [5.49] -32 UNEF-2A Thread								
031-0036-0001	1	.760 19.30	.255 6.48	.093 2.36		408-08522	RF-ASMB-89	010-0004-0000
031-0048-0001	2	.880 22.35	.140 3.56	.093 2.36		408-08525	RF-ASMB-95	010-0004-0000
031-0090-0001	1	.760 19.30	.255 6.48	.109 2.77		408-08522	RF-ASMB-89	010-0035-0000
S-93 Series (93 Ohm) .250 [6.35] -32 UNEF-2A Thread								
031-0032-0001	2	.880 22.35	.155 3.94	.134 3.40		408-08525	RF-ASMB-95	010-0005-0000
031-0037-0001	1	.760 19.30	.320 8.13	.134 3.40		408-08525	RF-ASMB-95	010-0005-0000
031-0088-0001	1	1.000 25.40	.320 8.13	.154 3.91		408-08533	RF-ASMB-106	—
031-0089-0001	2	.750 19.05	.140 3.56	.154 3.91	No Mounting Flat, Hex Nut Cable Clamp	408-08524	RF-ASMB-92	—

Receptacles

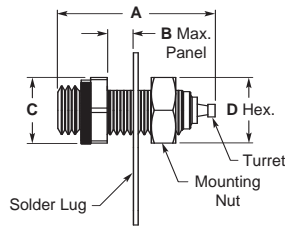

Fig. 1

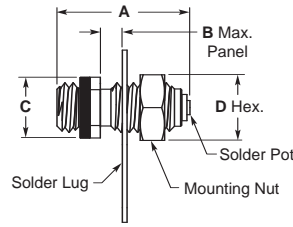
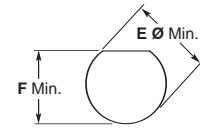

Fig. 2



Mounting Hole for Fig. 1 & 2

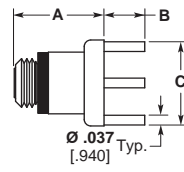

Fig. 3

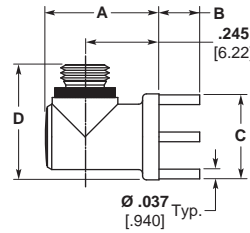
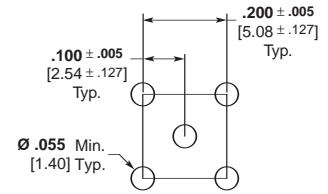

Fig. 4



Mounting Pattern for Fig. 3 & 4

Part No.	Fig.	Dim. A	Dim. B	Dim. C	Dim. D	Dim. E	Dim. F	Special Features	
S-50 Series (50 Ohm) .190 [4.83] -32 UNF-2A Thread									
031-0001-0001	2	.515 13.08	.080 2.03	.187 4.75	Wrench Flats	.250 6.35	.191 4.85	— No Mounting Flat	
031-0001-0003	2	.510 12.95	.110 2.80	.187 4.75	Wrench Flats	.250 6.35	.191 4.85	— No Mounting Flat	
031-0002-0001	2	.515 13.08	.150 3.81	.187 4.75	Wrench Flats	.250 6.35	.191 4.85	— No Mounting Flat	
031-0003-0001	2	.255 6.48	—	.187 4.75	Wrench Flats	—	.190 4.83	-32 — No Nut or Solder Lug, Threads into Panel	
031-0024-0001	2	.555 14.10	.120 3.05	.344 8.74	Wrench Flats	.438 11.13	.345 8.76	— Housing Isolated by Nylon Insulator	
031-0050-0001	1	.605 15.37	.160 4.06	.250 6.35	Hex.	.250 4.75	.191 4.85	.173 4.39	
031-0059-0001	3	.340 8.64	.155 3.93	.330 8.38	Dia.	—	—	—	
031-0061-0001	4	.425 10.80	.155 3.93	.330 8.38	Dia.	.480 12.20	—	—	
031-0062-0001	3	.345 8.76	.250 6.35	.330 8.38	Dia.	—	—	—	
051-0125-0001	2	.315 8.00	.125 3.18	.187 4.75	Wrench Flats	—	.138 3.50	— No Mounting Thread, Solder or Press into Panel	
051-0318-0001	1	.605 15.37	.160 4.06	.250 6.35	Hex.	.250 4.75	.191 4.85	.173 4.39	w/ Safety Wire Holes, .014 [.355] Wire Max.
051-0450-0001	3	.340 8.64	.050 1.27	.330 8.38	Dia.	—	—	—	
051-0459-0001	4	.425 10.80	.155 3.93	.330 8.38	Dia.	.480 12.20	—	—	3 Outer Legs
S-70 Series (70 Ohm) .216 [5.49] -32 UNEF-2A Thread									
031-0017-0001	2	.555 14.10	.100 2.54	.250 6.35	Hex.	.281 7.14	.217 5.51	— No Mounting Flat	
031-0018-0001	2	.555 14.10	.160 4.06	.250 6.35	Hex.	.281 7.14	.217 5.51	— No Mounting Flat	
031-0051-0001	1	.605 15.37	.160 4.06	.250 6.35	Hex.	.281 7.14	.217 5.51	.197 5.00	
031-0069-0001	3	.340 8.64	.155 3.94	.330 8.38	Dia.	—	—	—	
031-0072-0001	4	.425 10.80	.155 3.94	.330 8.38	Dia.	.480 12.20	—	—	

Receptacles (Continued)

Part No.	Fig.	Dim. A	Dim. B	Dim. C	Dim. D	Dim. E	Dim. F	Special Features
S-93 Series (93 Ohm) .250 [6.35] -32 UNEF-2A Thread								
031-0016-0001	2	.555 14.10	.100 2.54	.312 7.92	Hex.	.312 7.92	.251 6.38	— No Mounting Flat
031-0019-0001	2	.555 14.10	.160 2.54	.312 7.92	Hex.	.312 7.92	.251 6.38	— No Mounting Flat
031-0046-0001	2	.555 3.05	.120 3.05	.345 8.76	Wrench Flats	.438 11.13	.345 8.76	— Housing Isolated by Nylon Insulator
031-0052-0001	1	.605 15.37	.160 2.54	.312 7.92	Hex.	.312 7.92	.251 6.38	.232 5.89
031-0067-0001	3	.340 8.64	.155 3.94	.330 8.38	Dia.	—	—	—
031-0073-0001	4	.425 10.80	.155 3.94	.330 8.38	Dia.	.480 12.20	—	—
031-0080-0001	3	.345 8.76	.250 6.35	.330 8.38	Dia.	—	—	—

All plugs shown below mate with all jacks/receptacles shown below.



Plug

SOS-50 Ohm Series	SOS-70 Ohm Series	SOS-93 Ohm Series
032-0055-0001	032-0060-0001	032-0077-0001
	032-0087-0001	032-0084-0001

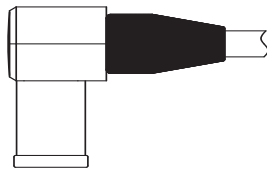

Right-Angle Plug

SOS-50 Ohm Series	SOS-70 Ohm Series	SOS-93 Ohm Series
032-0063-0001	032-0062-0001	032-0059-0001
		032-0083-0001

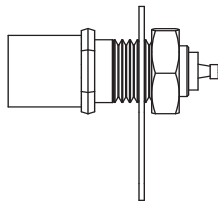

Plug Receptacle

SOS-50 Ohm Series	SOS-70 Ohm Series	SOS-93 Ohm Series
032-0042-0001	032-0042-0001	032-0042-0001
052-0061-0001	052-0061-0001	052-0061-0001
052-0471-0001	052-0471-0001	052-0471-0001

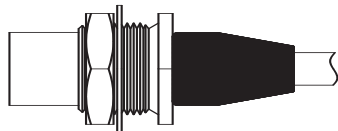

Bulkhead Plug

SOS-50 Ohm Series	SOS-70 Ohm Series	SOS-93 Ohm Series
032-0056-0001	032-0061-0001	032-0058-0001



Jack

SOS-50 Ohm Series	SOS-70 Ohm Series	SOS-93 Ohm Series
031-0053-0001	031-0095-0001	031-0063-0001
		031-0093-0001

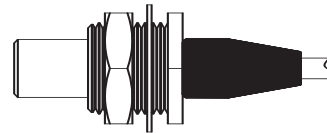

Bulkhead Jack

SOS-50 Ohm Series	SOS-70 Ohm Series	SOS-93 Ohm Series
031-0054-0001		031-0064-0001
		031-0094-0001

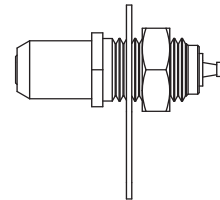

Receptacle

SOS-50 Ohm Series	SOS-70 Ohm Series	SOS-93 Ohm Series
031-0049-0001	031-0049-0001	031-0049-0001
051-0258-0001	051-0258-0001	051-0258-0001
051-0325-0001	051-0325-0001	051-0325-0001

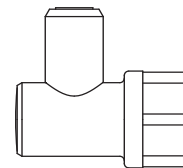

Right-Angle Printed Circuit Receptacle

SOS-50 Ohm Series	SOS-70 Ohm Series	SOS-93 Ohm Series
031-0070-0001	031-0070-0001	031-0070-0001

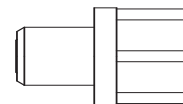

Printed Circuit Receptacle

SOS-50 Ohm Series	SOS-70 Ohm Series	SOS-93 Ohm Series
031-0060-0001	031-0060-0001	031-0060-0001
031-0065-0001	031-0065-0001	031-0065-0001

Standard Connectors — Slide-On Series (Continued)

Straight Plugs



Fig. 1

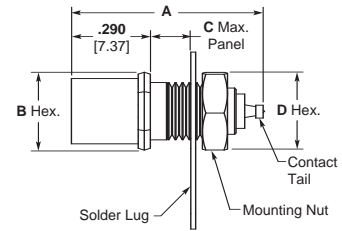

Fig. 2
Plug Receptacle

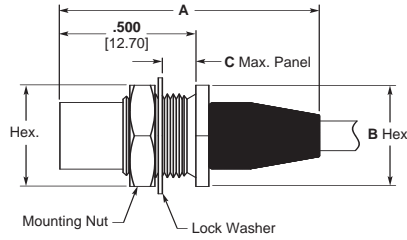
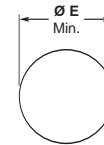

Fig. 3
Bulkhead Plug



Mounting Hole
for Fig. 2 & 3

Part No.	Fig.	Dim. A	Dim. B	Dim. C	Dim. D	Dim. E	Cable Max. Jacket	Special Features	Instruction Sheet No.	Former MICRODOT I.S. No.	Assembly Tool
SOS-50 Series (50 Ohm)											
032-0042-0001	2	.705 17.91	.250 6.35	.160 4.06	.281 7.14	.217 5.51	—	Turret Pin Contact Tail	—	—	—
032-0055-0001	1	.870 22.10	.250 6.35	—	—	—	.088 2.24	—	408-08526	RF-ASMB-97	010-0007-0000
032-0056-0001	3	.950 24.13	.375 9.53	.145 3.68	.375 9.53	.313 7.95	.088 2.24	—	408-08526	RF-ASMB-97	010-0007-0000
052-0061-0001	2	.750 19.05	.250 6.35	.160 4.06	.281 7.14	.217 5.51	—	Solder Pot Contact Tail	—	—	—
052-0471-0001	2	.590 14.99	.250 6.35	.095 2.41	.281 7.14	.217 5.51	—	Straight Pin Contact Tail ¹	—	—	—
SOS-70 Series (70 Ohm)											
032-0042-0001	2	.705 17.91	.250 6.35	.160 4.06	.281 7.14	.217 5.51	—	Turret Pin Contact Tail	—	—	—
032-0060-0001	1	.880 22.35	.250 6.35	—	—	—	.093 2.36	—	408-08529	RF-ASMB-102	010-0007-0000
032-0061-0001	3	.960 24.38	.375 9.53	.145 3.68	.375 9.53	.313 7.95	.093 2.36	—	408-08526	RF-ASMB-97	010-0007-0000
032-0087-0001	1	.880 22.35	.250 6.35	—	—	—	.108 2.24	—	408-08526	RF-ASMB-97	010-0036-0000
052-0061-0001	2	.750 19.05	.250 6.35	.160 4.06	.281 7.14	.217 5.51	—	Solder Pot Contact Tail	—	—	—
052-0471-0001	2	.590 14.99	.250 6.35	.095 2.41	.281 7.14	.217 5.51	—	Straight Pin Contact Tail ¹	—	—	—
SOS-93 Series (93 Ohm)											
032-0042-0001	2	.705 17.91	.250 6.35	.160 4.06	.281 7.14	.217 5.51	—	Turret Pin Contact Tail	—	—	—
032-0058-0001	3	.960 24.38	.375 9.53	.145 3.68	.375 9.53	.313 7.95	.134 3.40	—	408-08529	RF-ASMB-102	010-1008-0000
032-0077-0001	1	.880 22.35	.250 6.35	—	—	—	.134 3.40	—	408-08529	RF-ASMB-102	010-1008-0000
032-0084-0001	1	1.06 26.92	.250 6.35	—	—	—	.154 3.91	—	408-08523	RF-ASMB-90	—
052-0061-0001	2	.750 19.05	.250 6.35	.160 4.06	.281 7.14	.217 5.51	—	Solder Pot Contact Tail	—	—	—
052-0471-0001	2	.590 14.99	.250 6.35	.095 2.41	.281 7.14	.217 5.51	—	Straight Pin Contact Tail ¹	—	—	—

¹Lockwasher supplied in place of solder lug.

Standard Connectors — Slide-On Series (Continued)

Jacks

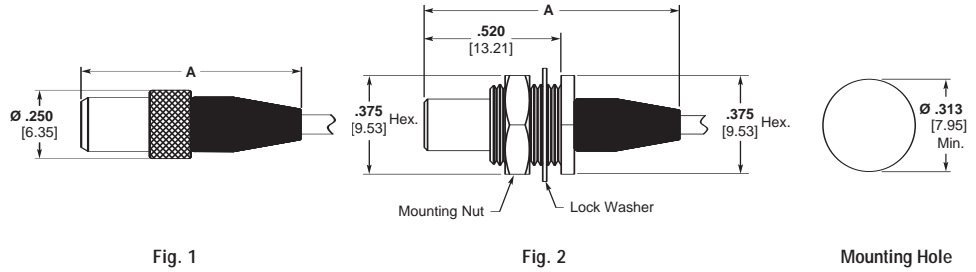

Part No.	Fig.	Dim. A	Cable Jacket Max.	Special Features	Instruction Sheet No.	Former MICRODOT I.S. No.	Assembly Tool
SOS-50 Series (50 Ohm)							
031-0053-0001	1	.800 20.32	.088 2.24		408-08531	RF-ASMB-104	010-0007-0000
031-0054-0001	2	.970 24.64	.088 2.24		408-08531	RF-ASMB-104	010-0007-0000
SOS-70 Series (70 Ohm)							
031-0095-0001	1	.810 20.57	.108 2.74		408-08531	RF-ASMB-104	010-0036-0000
SOS-93 Series (93 Ohm)							
031-0063-0001	1	.810 20.57	.134 3.40		408-08530	RF-ASMB-103	010-1008-0000
031-0064-0001	2	.980 24.89	.134 3.40		408-08530	RF-ASMB-103	010-1008-0000
031-0093-0001	1	1.100 27.94	.154 3.91	.305 [7.75] Dia. Over B.R. Cap	408-08532	RF-ASMB-105	—
031-0094-0001	2	.750 19.05	.154 3.91	Hex Nut Cable Clamp	408-08524	RF-ASMB-92	—

Right-Angle Plugs

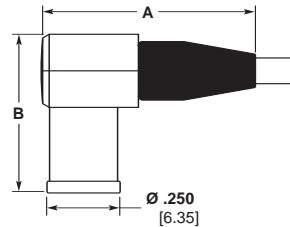

Part No.	Dim. A	Dim. B	Cable Max. O.D.	Special Features	Instruction Sheet No.	Former MICRODOT I.S. No.	Assembly Tool
SOS-50 Series (50 Ohm)							
032-0063-0001	.735 18.67	.545 13.84	.092 2.34		408-08520	RF-ASMB-87	010-0016-0000
SOS-70 Series (70 Ohm)							
032-0062-0001	.745 18.92	.545 13.84	.111 2.82		408-08520	RF-ASMB-87	010-0016-0000
SOS-93 Series (93 Ohm)							
032-0059-0001	.745 18.92	.605 15.37	.134 3.40		408-08520	RF-ASMB-87	010-0017-0000
032-0083-0001	.745 18.92	.605 15.37	.155 3.94		408-08520	RF-ASMB-87	010-0017-0000

Standard Connectors — Slide-On Series (Continued)

Receptacles

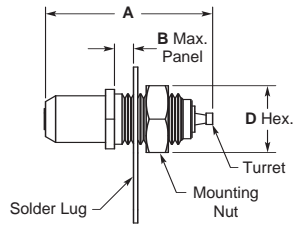

Fig. 1

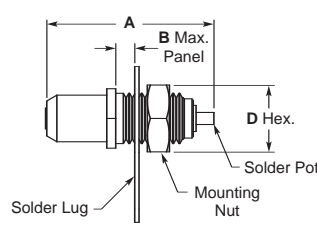
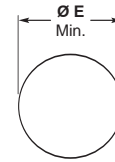

Fig. 2



Mounting Hole for Fig. 1 & 2

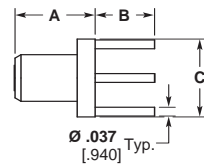

Fig. 3

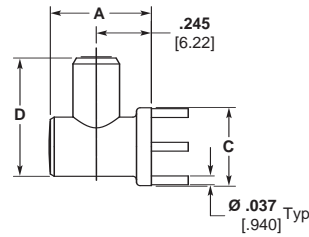
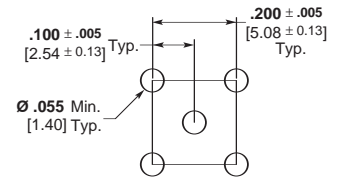

Fig. 4



Mounting Pattern for Fig. 3 & 4

Part No.	Fig.	Dim. A	Dim. B	Dim. C	Dim. D	Dim. E	Special Features
SOS-50 (50 Ohm), SOS-70 (70 Ohm), & SOS-93 (93 Ohm) Series							
031-0049-0001	1	.715 18.16	.160 4.06	.250 Hex. 6.35	.281 7.14	.217 5.51	
031-0060-0001	3	.340 8.64	.155 3.94	.330 Dia. 8.38	—	—	
031-0065-0001	3	.340 8.64	.250 6.35	.330 Dia. 8.38	—	—	
031-0070-0001	4	.425 10.79	.155 3.94	.330 Dia. 8.38	.540 13.72	—	
051-0258-0001	2	.715 18.16	.160 4.06	.250 Hex. 6.35	.281 7.14	.217 5.51	
051-0325-0001	1	.570 14.48	.140 3.56	.250 Hex. 6.35	—	.216-32 5.49 Thd.	No Nut or Lockwasher, Threads into Panel

Standard Connectors — Quick-Connect Series



Plug

QC-50 Ohm Series	QC-70 Ohm Series	QC-93 Ohm Series
032-0002-0001	032-0016-0001	032-0012-0001
032-0030-0001	032-0031-0001	032-0032-0001
	032-0079-0001	032-0072-0001



Jack

QC-50 Ohm Series	QC-70 Ohm Series	QC-93 Ohm Series
031-0038-0001		031-0040-0001

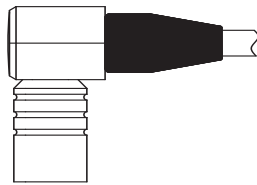

Right-Angle Plug

QC-50 Ohm Series	QC-70 Ohm Series	QC-93 Ohm Series
032-0026-0001	032-0027-0001	032-0020-0001
		052-0228-0001

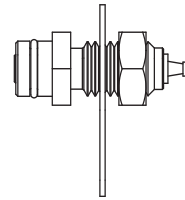

Receptacle

QC-50 Ohm Series	QC-70 Ohm Series	QC-93 Ohm Series
031-0057-0001	031-0057-0001	031-0058-0001
		031-0085-0001

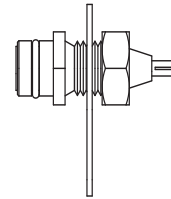

Receptacle

QC-50 Ohm Series	QC-70 Ohm Series	QC-93 Ohm Series
031-0004-0001	031-0004-0001	031-0020-0001
031-0005-0001	031-0005-0001	031-0021-0001
031-0006-0001	031-0006-0001	
051-0586-0001	051-0586-0001	

Straight Plugs

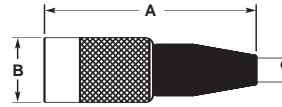

Part No.	Dim. A	Dim. B	Cable Jacket Max.	Special Features	Instruction Sheet No.	Former MICRODOT I.S. No.	Assembly Tool
QC-50 Series (50 Ohm)							
032-0002-0001	.820 20.83	.250 6.35	.093 2.36	Solderless Assembly	408-08527	RF-ASMB-100	010-0007-0000
032-0030-0001	.820 20.83	.250 6.35	.093 2.36		408-08526	RF-ASMB-97	010-0007-0000
QC-70 Series (70 Ohm)							
032-0016-0001	.830 21.08	.250 6.35	.093 2.36	Solderless Assembly	408-08527	RF-ASMB-100	010-0007-0000
032-0031-0001	.830 21.08	.250 6.35	.093 2.36		408-08529	RF-ASMB-102	010-0007-0000
032-0079-0001	.840 21.34	.250 6.35	.108 2.74		408-08526	RF-ASMB-97	010-0036-0000
QC-93 Series (93 Ohm)							
032-0012-0001	.845 21.46	.312 7.92	.134 3.40	Solderless Assembly	408-08527	RF-ASMB-100	010-0008-0000
032-0032-0001	.845 21.46	.312 7.92	.134 3.40		408-08529	RF-ASMB-102	010-0008-0000
032-0072-0001	1.050 26.67	.312 7.92	.154 3.91	Mates with 031-0085-0001 Only	408-08523	RF-ASMB-90	—

Right-Angle Plugs

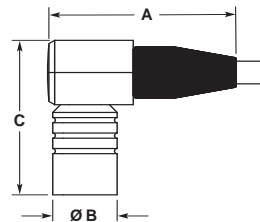

Part No.	Dim. A	Dim. B	Dim. C	Cable Jacket Max.	Special Features	Instruction Sheet No.	Former MICRODOT I.S. No.	Assembly Tool
QC-50 Series (50 Ohm)								
032-0026-0001	.735 18.67	.250 6.35	.605 15.37	.092 2.34		408-08520	RF-ASMB-87	010-0016-0000
QC-70 Series (70 Ohm)								
032-0027-0001	.745 18.92	.250 6.35	.605 15.37	.111 2.82		408-08520	RF-ASMB-87	010-0016-0000
QC-93 Series (93 Ohm)								
032-0020-0001	.745 18.92	.312 7.92	.635 16.13	.134 3.40		408-08520	RF-ASMB-87	010-0017-0000
052-0228-0001	.745 18.92	.312 7.92	.720 18.29	.155 3.94	Mates with 031-0085-0001 Only	408-08520	RF-ASMB-87	010-0017-0000

Standard Connectors — Quick-Connect Series (Continued)

Jacks

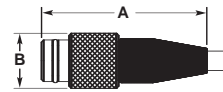

Part No.	Dim. A	Dim. B	Cable Jacket Max.	Special Features	Instruction Sheet No.	Former MICRODOT I.S. No.	Assembly Tool
QC-50 Series (50 Ohm)							
031-0038-0001	.750 19.05	.250 6.35	.093 2.36		408-08531	RF-ASMB-104	010-0007-0000
QC-93 Series (93 Ohm)							
031-0040-0001	.760 19.30	.320 8.13	.134 3.40		408-08530	RF-ASMB-103	010-1009-0000

Receptacles

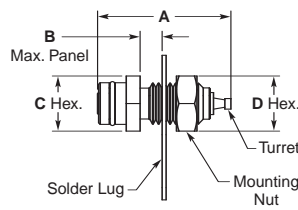

Fig. 1

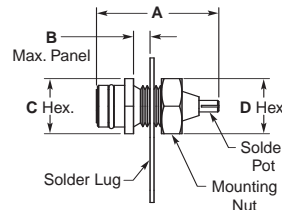
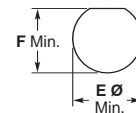

Fig. 2



Mounting Hole

Part No.	Fig.	Dim. A	Dim. B	Dim. C	Dim. D	Dim. E	Dim. F	Special Features
QC-50 Series (50 Ohm) & QC-70 Series (70 Ohm)								
031-0004-0001	2	.555 14.10	.095 2.41	.250 6.35	.250 6.35	.191 4.85	—	No Mounting Flat
031-0005-0001	2	.555 14.10	.165 4.19	.250 6.35	.250 6.35	.191 4.85	—	No Mounting Flat
031-0006-0001	2	.250 6.35	—	.250 6.35	—	.190-32 4.83 Thd	—	No Nut or Solder Lug, Threads into Panel
031-0057-0001	1	.605 15.37	.165 4.19	.250 6.35	.250 6.35	.191 4.85	.173 4.39	
051-0586-0001	2	.555 14.10	.165 4.19	.250 6.35	.250 6.35	.191 4.85	—	No Mounting Flat, Split Solder Lug
QC-93 Series (93 Ohm)								
031-0020-0001	2	.555 14.10	.095 2.41	.312 7.92	.312 7.92	.251 6.38	—	No Mounting Flat
031-0021-0001	2	.555 14.10	.165 4.19	.312 7.92	.312 7.92	.251 6.38	—	No Mounting Flat
031-0058-0001	1	.605 15.37	.160 4.06	.312 7.92	.312 7.92	.251 6.38	.232 5.89	
031-0085-0001	1	.715 18.16	.165 4.19	.312 7.92	.312 7.92	.251 6.38	—	No Mounting Flat, Mates with 032-0072-0001 & 052-0228-0001 Only

Standard Connectors — Twinax Series

Twinax Plugs: ☺
 For cables with two inner conductors and one shield

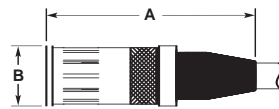

Fig. 1
Slide-On Series

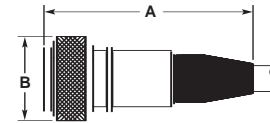

Fig. 2
Screw-On Series

Part No.	Fig.	Dim. A	Dim. B	Cable Jacket Max.	Special Features	Instruction Sheet No.	Former MICRODOT I.S. No.	Assembly Tool
032-0088-0001	1	1.085 27.56	.312 7.92	.167 4.24		408-08528	RF-ASMB-101	010-0031-0000
032-0093-0001	1	1.085 27.56	.312 7.92	.123 3.12		408-08528	RF-ASMB-101	010-0031-0000
052-0229-0001	2	1.085 27.56	.440 11.18	.123 3.12		408-08517	RF-ASMB-61	010-0172-0000
052-0324-0001	2	1.095 27.81	.440 11.18	.167 4.24		408-08517	RF-ASMB-61	010-0172-0000

Twinax Receptacles and Jacks: ☹

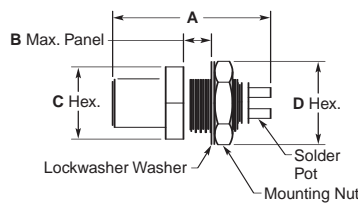

Fig. 1
Slide-On Series

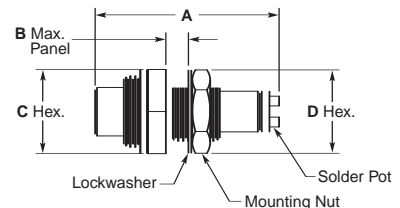

Fig. 2
Slide-On Series or Screw-On Series

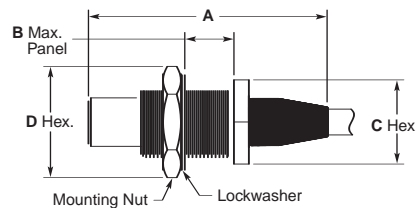
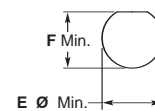

Fig. 3
Slide-On Series or Screw-On Series



Mounting Hole

Part No.	Fig.	Dim. A	Dim. B	Dim. C	Dim. D	Dim. E	Dim. F	Cable Max. Jacket	Special Features	Instruction Sheet No.	Former MICRODOT I.S. No.	Assembly Tool
031-0098-0001	1	.812 20.62	.155 3.94	.375 9.53	.375 9.53	.313 7.95	.292 7.42	—		—	—	—
051-0248-0001	2	.960 24.38	.155 3.94	.437 11.10	.375 9.53	.313 7.95	.292 7.42	—		—	—	—
051-0358-0001	3	1.060 26.92	.075 ¹ 1.91	.437 11.10	.500 12.7	.376 9.55	.351 8.92	.167 4.24	Lockwasher not included	408-08516	RF-ASMB-44	010-0186-0000
051-0389-0001	3	1.255 31.88	.255 ² 6.48	.437 11.10	.500 12.7	.376 9.55	.351 8.92	.167 4.24		408-08516	RF-ASMB-44	010-0186-0000

¹.075 [1.91] Max. Panel when mated with a Screw-On plug, .180 [4.57] Max. Panel when mated with a Slide-On plug.

².255 [6.48] Max. Panel when mated with a Screw-On plug, .360 [9.14] Max. Panel when mated with a Slide-On plug.

Triax Plugs: 

For cables with one inner conductor and two isolated shields

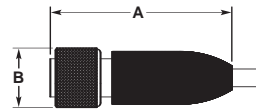

Part No.	Dim. A	Dim. B	Cable Jacket Max.	Special Features	Instruction Sheet No.	Former MICRODOT I.S. No.	Assembly Tool
052-0130-0001	1.37 34.80	.440 11.18	Dia. .124 3.15		408-08514	RF-ASMB-20	—
052-0138-0001	1.37 34.80	.440 11.18	Dia. .183 4.65		408-08515	RF-ASMB-21	—
052-0593-0001	1.37 34.80	.438 11.13	Hex. .214 5.44	Hex Nut w/ Safety Wire Holes, .027 [.686] Wire Max.	408-08518	RF-ASMB-73	—

Triax Receptacle: 

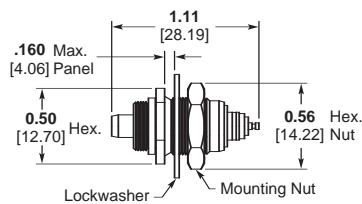

Part Number 051-0618-0001

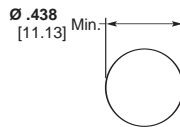

Mounting Hole

Triax Adapter: 

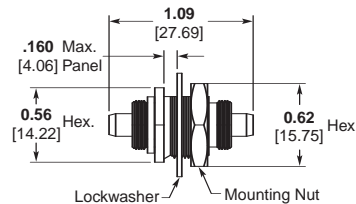

Part Number 053-0161-0001
Mates with Triax Plug, Both Ends

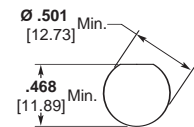

Mounting Hole

Terminals

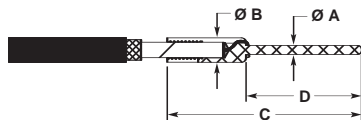

Fig. 1



Fig. 2

Part No.	Fig.	Dim. A	Dim. B	Dim. C	Dim. D	Cable Max. Dielectric	Cable Max. Inner Conductor
053-0354-0003	1	.030 .762	.080 2.03	.630 16.00	.375 9.53	.050 1.27	.015 .381
053-0249-0001	1	.030 .762	.105 2.67	.630 16.00	.375 9.53	.071 1.80	.021 .533
053-0495-0001	1	.030 .762	.125 3.18	.880 22.35	.610 15.49	.083 2.11	.022 .559
053-0656-0001	1	.030 .762	.145 3.68	.880 22.35	.375 9.53	.108 2.74	.023 .584
053-0294-0002	1	.030 .762	.145 3.68	.880 22.35	.625 15.88	.108 2.74	.023 .584
033-0115-0002	2	.040 1.02	.063 1.60	.255 6.48	.100 2.54	.042 1.07	.023 .584
033-0116-0001	2	.040 1.02	.094 2.39	.300 7.62	.100 2.54	.068 1.73	.023 .584
033-0117-0001	2	.040 1.02	.140 3.56	.350 8.89	.200 5.08	.108 2.74	.023 .584
053-0154-0001	1	.041 1.04	.080 2.03	.430 10.92	.175 4.45	.050 1.27	.019 .483
053-0250-0001	1	.041 1.04	.080 2.03	.505 12.83	.250 6.35	.050 1.27	.019 .483
053-0020-0003	1	.041 1.04	.080 2.03	.630 16.00	.375 9.53	.050 1.27	.015 .381
053-0021-0003	1	.041 1.04	.105 2.67	.630 16.00	.375 9.53	.071 1.80	.023 .584
053-0267-0003	1	.041 1.04	.105 2.67	.875 22.23	.625 15.88	.071 1.80	.023 .584
053-0265-0001	2	.041 1.04	.128 3.25	.505 12.83	.250 6.35	.102 2.59	.021 .533
053-0230-0001	2	.041 1.04	.128 3.25	.630 16.00	.375 9.53	.102 2.59	.018 .457
053-0155-0001	1	.041 1.04	.145 3.68	.430 10.82	.175 4.45	.108 2.74	.023 .584
053-0022-0003	1	.041 1.04	.145 3.68	.630 16.00	.375 9.53	.108 2.74	.023 .584
053-0388-0001	2	.042 1.07	.098 2.49	.500 12.70	.250 6.35	.065 1.65	.021 .533
053-0251-0001	2	.042 1.07	.098 2.49	.630 16.00	.375 9.53	.065 1.65	.021 .533

Terminals are gold plated. See applicable MICRODOT drawing for solder and crimp instructions.

Electronics

Standard Connectors — Module Blocks

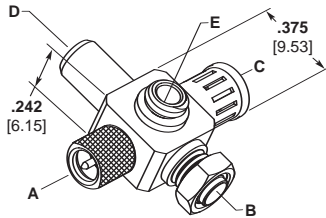

The five faces of basic block can be used to mount any one of 10 different terminations. The 5 faces are coded with letters as shown above. The 10 terminations are coded with Nos. 1–10. Part number, to be complete, must show face location and termination Nos.

desired. (Ex: illustration shows 033-0042—A2—B7—C6—D5—E1) Ordering part number will be converted to a MICRODOT assigned number at time of ordering.

We do not stock complete assemblies.

Size	Part No.	Dim. H
50 Ohm	033-0042*	.250 6.35
70 Ohm	033-0043*	.250 6.35
93 Ohm	033-0044*	.300 7.62

*Part number to be completed by customer. A Computer Part Number will be assigned by Tyco Electronics.

Interfaces/Terminations

Termination Number	1	2	3	4	5	6
Mating Type	S	S	QC	QC	SOS	SOS
Description	Receptacle	Plug with Knurl Nut	Receptacle	Plug	Receptacle	Plug
	Thread	Thread Dia.		Dia.		Dia.
50 Series	.190-32 UNF 4.83	.190-32 UNF 4.83	.230 5.84	.250 6.35		.250 6.35
70 Series	.216-32 UNEF 5.49	.216-32 UNEF 5.49	.255 6.48	.250 6.35		.250 6.35
93 Series	.250-32 UNEF 6.35	.250-32 UNEF 6.35	.320 8.13	.312 7.92		.250 6.35

Interfaces/Terminations (Continued)

Termination Number	7	8	9	10
Mating Type	—	—	S	S
Description	Bulkhead Stud	Bulkhead Receptacle	Plug with Hex. Nut	Plug, Hex. Nut With Wire Holes
	Thread	Thread Hex. Min. Hole Dia. Min. Hole Height	Thread Hex.	Thread Hex.
50 Series	.190-32 UNF 4.83	.190-32 UNF .250 4.83 6.35	.190-32 UNF .250 4.83 6.35	.190-32 UNF .250 4.83 6.35
70 Series	.190-32 UNF 4.83	.216-32 UNEF .281 5.49 7.14	.216-32 UNEF .281 5.49 7.14	.216-32 UNEF .281 5.49 7.14
93 Series	.190-32 UNF 4.83	.250-32 UNEF .312 6.35 7.92	.250-32 UNEF .312 6.35 7.92	.250-32 UNEF .312 6.35 7.92

Caps, Screw-On Series
For Receptacles and Jacks

Standard Connectors — Caps, Hoods

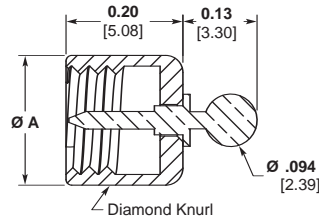

Fig. 1
With Grounding Pin

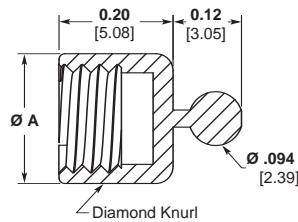

Fig. 2
Without Grounding Pin

Part No.	Fig.	Dim. A
S-50 Series		
033-0046-0001	1	.235 5.97
033-0056-0001	2	.235 5.97
S-70 Series		
033-0047-0001	1	.255 6.48
033-0057-0001	2	.255 6.48
S-93 Series		
033-0048-0001	1	.315 8.00
033-0058-0001	2	.315 8.00

Material — Brass per QQ-B-626

Finish — Silver plate per QQ-S-365, .0002 [.005] min.

Note: All caps can be supplied with .094 [2.39] Dia. bead chain and end ring. When ordering, specify chain length and end ring hole size (.130 [3.30], .140 [3.56], .167 [4.24], or .193 [4.90] Dia.)

Receptacle Hoods

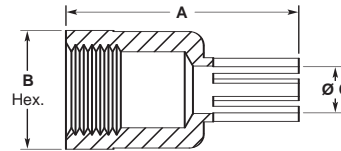

Part No.	Dim. A	Dim. B	Dim. C	Thread	For Receptacle Series
033-0067-0001	.490 12.45	.250 6.35	.098 2.49	.190-32 UNF 4.83	S-50, QC-50, QC-70
033-0068-0001	.490 12.45	.250 6.35	.114 2.90	.216-32 UNEF 5.49	S-70, SOS-50, SOS-70, SOS-93
033-0069-0001	.490 12.45	.312 7.92	.156 3.96	.250-32 UNEF 6.35	S-93, QC-93
033-0084-0001	.490 12.45	.250 6.35	.156 3.96	.216-32 UNEF 5.49	S-70, SOS-50, SOS-70, SOS-93
053-0147-0001	.840 21.34	.437 11.10	.156 3.96	.375-32 UNEF 9.53	Twinax/Triax Receptacle

Material — Brass per QQ-B-626

Finish — Silver plate per QQ-S-365, .0002 [.005] min.

Standard Connectors — Adapters

Feed-Thru Adapters for Screw-On Series

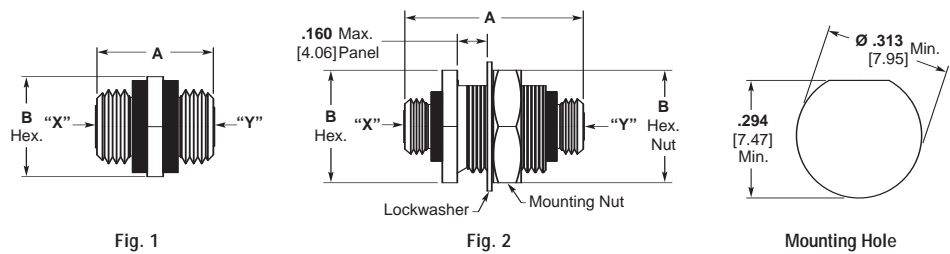

Part No.	Fig.	Dim. A	Dim. B	End "X" Is	End "Y" Is
033-0001-0001	1	.300 7.62	.250 6.35	S-50 Receptacle	S-50 Receptacle
033-0053-0001	2	.600 15.24	.375 9.53	S-50 Receptacle	S-50 Receptacle
033-0023-0001	1	.400 10.16	.250 6.35	S-70 Receptacle	S-70 Receptacle
033-0054-0001	2	.600 15.24	.375 9.53	S-70 Receptacle	S-70 Receptacle
033-0036-0001	1	.410 10.41	.312 7.92	S-93 Receptacle	S-93 Receptacle
033-0055-0001	2	.600 15.24	.375 9.53	S-93 Receptacle	S-93 Receptacle

BNC and TNC/MICRODOT Adapters for Screw-On, Slide-On, and Quick-Connect Series

For mating BNC/TNC connectors to MICRODOT standard connectors.

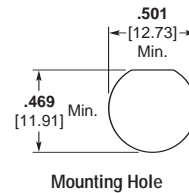

End "A" Is:	Configuration	End "B" Is:	50 Series Part No.	70 Series Part No.	93 Series Part No.
BNC Plug		Screw-On (S) Type Plug	033-0103-0001	033-0107-0001	033-0111-0001
BNC Plug		Screw-On Type Receptacle	033-0101-0001	033-0105-0001	033-0109-0001
BNC Receptacle		Screw-On (S) Type Plug	033-0104-0001	053-0108-0001	033-0112-0001
BNC Receptacle		Screw-On (S) Type Receptacle	033-0102-0001	033-0106-0001	033-0110-0001
BNC Bulkhead Receptacle		Screw-On (S) Type Plug	033-0127-0001 ¹	—	033-0129-0001 ¹

¹Mounting information: Housing Hex. .688 [17.48], Mtg. Nut Hex. .625 [15.88], Max. Panel .090 [2.29].

BNC and TNC/MICRODOT Adapters for Screw-On, Slide-On, and Quick-Connect Series (Continued)

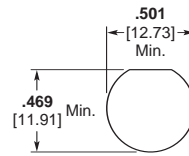

Mounting Hole

End "A" Is:	Configuration	End "B" Is:	50 Series Part No.	70 Series Part No.	93 Series Part No.
BNC Bulkhead Receptacle		Screw-On (S) Type Receptacle	033-0090-0001 ¹	033-0125-0001 ¹	033-0126-0001 ¹
TNC Plug		Screw-On (S) Type Receptacle	033-0141-0001	033-0143-0001	033-0145-0001
TNC Receptacle		Screw-On (S) Type Receptacle	033-0153-0001	—	—
BNC Plug		Slide-On (SOS) Type Plug	053-0339-0001	053-0339-0001	053-0339-0001
BNC Plug		Slide-On (SOS) Type Receptacle	033-0081-0001	033-0081-0001	033-0081-0001
BNC Receptacle		Slide-On (SOS) Type Plug	033-0092-0001	033-0092-0001	033-0092-0001
BNC Receptacle		Slide-On (SOS) Type Receptacle	033-0082-0001	033-0082-0001	033-0082-0001
BNC Bulkhead Receptacle		Slide-On (SOS) Type Receptacle	033-0124-0001 ¹	033-0124-0001 ¹	033-0124-0001 ¹
BNC Plug		Quick-Connect (QC) Type Receptacle	033-0093-0001	033-0093-0001	033-0097-0001
BNC Receptacle		Quick-Connect (QC) Type Receptacle	033-0094-0001	033-0094-0001	—

¹Mounting information: Housing Hex. .688 [17.48], Mtg. Nut Hex. .625 [15.88], Max. Panel .090 [2.29].

Performance Data Summary
For Gold Plated Crimp Style Coaxial Connectors

Gold Plated Crimp Style Coaxial Connectors

Mechanical

Captive Contacts — Terminated connector contacts captivated from movement in both directions.

Cable Retention —
50 Ohm connectors, 15 lb. min.
70 Ohm connectors, 25 lb. min.
93 Ohm connectors, 25 lb. min.

Recommended Coupling Torque (Threaded Interface) —
8 inch/pounds max. [.904 Nm]

Recommended Receptacle Mounting Torque (Threaded Interface) — 8 inch/pounds max. [.904 Nm]

Contact Protection (Unmated) —
Pin contact protected by coupling nut.
Socket protected by insulator and housing.

Assembly Methods

Straight Plugs & Jacks — Cable Inner Conductor: Crimped to contact. Cable Shield: Crimped under housing.

Right-Angle Plugs — Cable Inner Conductor: Crimped to contact. Cable Shield: Crimped under housing.

Environmental

Temperature Range (Continuous Service) — -80°F to +392°F. [-62°C to +200°C].

Vibration^{1,2} — MIL-STD-202, Method 204, Test condition B (15 G peak). No physical damage or electrical discontinuities in excess of 1 microsecond.

Shock^{1,2} — MIL-STD-202, Method 213, Test Condition H. No physical damage or electrical discontinuity after shock.

Thermal Shock — MIL-STD-202, Method 107, Test Condition C.

Moisture Resistance¹ — MIL-STD-202, Method 106.

Salt Spray¹ — MIL-STD-202, Method 101, Test Condition B (48 hours).

Electrical

Impedance — Designed to be compatible with 50, 70, or 93 Ohm miniature coaxial cable.

Dielectric Withstanding Voltage — 1000 volts RMS at sea level.

Contact Resistance — 4 milliohms max., D.C.

Contact Capacity — 3 amps, D.C.

Insulation Resistance — 5 x 10³ Megohms min. @ 500 volts D.C.

Voltage Standing Wave Ratio³ (VSWR) — Typical 50 Ohm series, 1.2 max. to 2 GHz.

Materials

Housing, Nut, Inner Sleeve — Brass per ASTM-B-16, 35% Zinc.

Insulator — TEFLON per ASTM-D-1710.

Pin & Socket Contacts — Beryllium Copper per ASTM-B-196.

Middle Sleeve — Copper Alloy.

Facial Seal⁴, Sealing Sleeve & Gasket — Silicone Rubber per ZZ-R-765.

Lockwasher — #425 Bronze Alloy.

Plating

Contacts, Housing, Nut, Inner Sleeve, Middle Sleeve, Lockwasher — Gold per MIL-G-45204, Type II, Grade C, Class 1.

NOTES:

¹Screw-On Series threaded interface.

²Tyco Electronics recommends the use of wired connectors in vibration and shock environments. See individual specifications for connectors with wire holes.

³VSWR is a system specification. Where performance is critical, purchase Tyco Electronics cable assemblies (See page 127) and specify VSWR testing and mating connector part numbers.



Gold Plated Crimp Style Coaxial Connectors — Screw-On Series

Straight Plugs

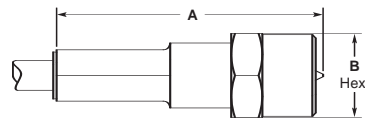

Fig. 1
Partial Hex. Nut

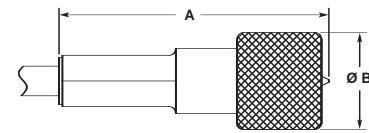

Fig. 2
Knurl Nut

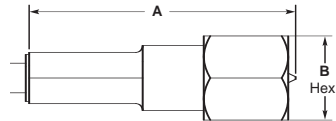

Fig. 3
Full Hex. Nut

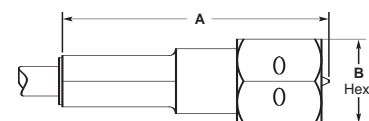

Fig. 4
Hex. Nut w/ 3 Safety Wire Holes

Part No.	Fig.	Dim. A	Dim. B	Cable Max.	Special Features	Instruction Sheet No.	Former MICRODOT I.S. No.
50 Ohm Series .190 [4.83] -32 UNF-2B Thread							
132-0112-0001	1	.800 20.32	.250 6.35	.088 2.24		408-08508	RF-ASMB-8
132-0112-0002	2	.800 20.32	.250 6.35	.088 2.24		408-08508	RF-ASMB-8
132-0112-0003	3	.800 20.32	.250 6.35	.088 2.24		408-08508	RF-ASMB-8
132-0112-0004	4	.800 20.32	.250 6.35	.088 2.24		408-08508	RF-ASMB-8
132-0113-0001	1	.800 20.32	.250 6.35	.088 2.24	With environmental seal	408-08508	RF-ASMB-8
132-0113-0002	2	.800 20.32	.250 6.35	.088 2.24	With environmental seal	408-08508	RF-ASMB-8
132-0113-0003	3	.800 20.32	.250 6.35	.088 2.24	With environmental seal	408-08508	RF-ASMB-8
132-0113-0004	4	.800 20.32	.250 6.35	.088 2.24	With environmental seal	408-08508	RF-ASMB-8
132-0114-0001	1	.800 20.32	.250 6.35	.110 2.79		408-08508	RF-ASMB-8
132-0114-0002	2	.800 20.32	.250 6.35	.110 2.79		408-08508	RF-ASMB-8
132-0114-0003	3	.800 20.32	.250 6.35	.110 2.79		408-08508	RF-ASMB-8
132-0114-0004	4	.800 20.32	.250 6.35	.110 2.79		408-08508	RF-ASMB-8
132-0115-0001	1	.800 20.32	.250 6.35	.110 2.79	With environmental seal	408-08508	RF-ASMB-8
132-0115-0002	2	.800 20.32	.250 6.35	.110 2.79	With environmental seal	408-08508	RF-ASMB-8
132-0115-0003	3	.800 20.32	.250 6.35	.110 2.79	With environmental seal	408-08508	RF-ASMB-8
132-0115-0004	4	.800 20.32	.250 6.35	.110 2.79	With environmental seal	408-08508	RF-ASMB-8
132-0509-0002	2	.800 20.32	.250 6.35	.116 2.95	Dual shield cable version of RG 188 & 316	408-08508	RF-ASMB-8
70 Ohm Series .216 [5.49] -32 UNEF-2B Thread							
132-0200-0001	1	.800 20.32	.281 7.14	.110 2.79		408-08508	RF-ASMB-8
132-0200-0002	2	.800 20.32	.290 7.37	.110 2.79		408-08508	RF-ASMB-8
132-0200-0003	3	.800 20.32	.281 7.14	.110 2.79		408-08508	RF-ASMB-8
132-0200-0004	4	.800 20.32	.281 7.14	.110 2.79		408-08508	RF-ASMB-8
132-0201-0001	1	.800 20.32	.281 7.14	.110 2.79	With environmental seal	408-08508	RF-ASMB-8
132-0201-0002	2	.800 20.32	.290 7.37	.110 2.79	With environmental seal	408-08508	RF-ASMB-8
132-0201-0003	3	.800 20.32	.281 7.14	.110 2.79	With environmental seal	408-08508	RF-ASMB-8
132-0201-0004	4	.800 20.32	.281 7.14	.110 2.79	With environmental seal	408-08508	RF-ASMB-8

Straight Plugs (Continued)

Part No.	Fig.	Dim. A	Dim. B	Cable Max.	Special Features	Instruction Sheet No.	Former MICRODOT I.S. No.
93 Ohm Series .250 [6.35] -32 UNEF-2B Thread							
132-0300-0001	1	.795 20.19	.312 7.92	.155 3.94		408-08508	RF-ASMB-8
132-0300-0002	2	.795 20.19	.320 8.13	.155 3.94		408-08508	RF-ASMB-8
132-0300-0003	3	.795 20.19	.312 7.92	.155 3.94		408-08508	RF-ASMB-8
132-0300-0004	4	.795 20.19	.312 7.92	.155 3.94		408-08508	RF-ASMB-8
132-0301-0001	1	.795 20.19	.312 7.92	.155 3.94	With environmental seal	408-08508	RF-ASMB-8
132-0301-0002	2	.795 20.19	.320 8.13	.155 3.94	With environmental seal	408-08508	RF-ASMB-8
132-0301-0003	3	.795 20.19	.312 7.92	.155 3.94	With environmental seal	408-08508	RF-ASMB-8
132-0301-0004	4	.795 20.19	.312 7.92	.155 3.94	With environmental seal	408-08508	RF-ASMB-8

Right-Angle Plugs

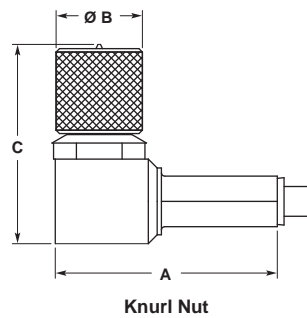

Part No.	Dim. A	Dim. B	Dim. C	Cable Jacket Max.	Special Features	Instruction Sheet No.	Former MICRODOT I.S. No.
50 Ohm Series .190 [4.83] -32 UNF-2B Thread							
132-0116-0002	.660 16.76	.250 6.35	.620 15.75	.088 2.24		408-08509	RF-ASMB-11
132-0117-0002	.660 16.76	.250 6.35	.620 15.75	.088 2.24	With environmental seal	408-08509	RF-ASMB-11
132-0118-0002	.695 17.65	.250 6.35	.650 16.51	.110 2.79		408-08509	RF-ASMB-11
132-0119-0002	.695 17.65	.250 6.35	.650 16.51	.110 2.79	With environmental seal	408-08509	RF-ASMB-11
70 Ohm Series .216 [5.49] -32 UNEF-2B Thread							
132-0202-0002	.695 17.65	.290 7.37	.650 16.51	.110 2.79		408-08509	RF-ASMB-11
132-0203-0002	.695 17.65	.290 7.37	.650 16.51	.110 2.79	With environmental seal	408-08509	RF-ASMB-11
93 Ohm Series .250 [6.35] -32 UNEF-2B Thread							
132-0302-0002	.710 18.03	.320 8.13	.680 17.27	.155 3.94		408-08509	RF-ASMB-11
132-0303-0002	.710 18.03	.320 8.13	.680 17.27	.155 3.94	With environmental seal	408-08509	RF-ASMB-11

Gold Plated Crimp Style Coaxial Connectors — Screw-On Series (Continued)

Jacks

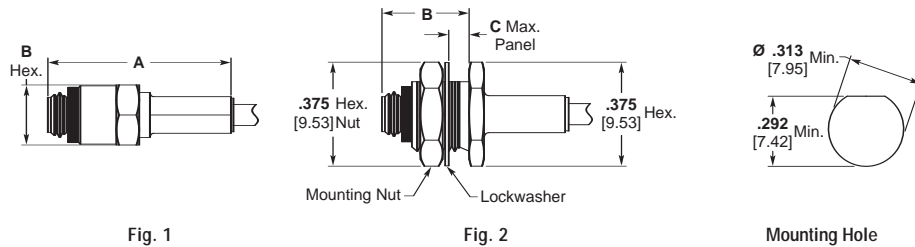

Part No.	Fig.	Dim. A	Dim. B	Dim. C	Cable Jacket Max.	Special Features	Instruction Sheet No.	Former MICRODOT I.S. No.
50 Ohm Series .190 [4.83] -32 UNF-2B Thread								
131-0134-0001	1	.770 19.56	.250 6.35	—	.088 2.24		408-08508	RF-ASMB-8
131-0135-0001	2	.770 19.56	.360 9.14	.105 2.67	.088 2.24		408-08508	RF-ASMB-8
131-0136-0001	1	.770 19.56	.250 6.35	—	.110 2.79		408-08508	RF-ASMB-8
131-0137-0001	2	.770 19.56	.360 9.14	.105 2.67	.110 2.79		408-08508	RF-ASMB-8
131-0150-0001	1	.770 19.56	.250 6.35	—	.116 2.95	Dual Shield Cable Version of RG 188 & 316	408-08508	RF-ASMB-8
131-0151-0001	2	.770 19.56	.360 9.14	.105 2.67	.116 2.95	Dual Shield Cable Version of RG 188 & 316	408-08508	RF-ASMB-8
70 Ohm Series .216 [5.49] -32 UNEF-2B Thread								
131-0200-0001	1	.770 19.56	.281 7.14	—	.110 2.79		408-08508	RF-ASMB-8
131-0201-0001	2	.770 19.56	.360 9.14	.100 2.54	.110 2.79		408-08508	RF-ASMB-8
93 Ohm Series .250 [6.35] -32 UNEF-2B Thread								
131-0300-0001	1	.760 19.30	.312 7.92	—	.155 3.94		408-08508	RF-ASMB-8
131-0301-0001	2	.760 19.30	.350 8.89	.095 2.41	.155 3.94		408-08508	RF-ASMB-8

Gold Plated Crimp Style Coaxial Connectors — Screw-On Series (Continued)

Receptacles

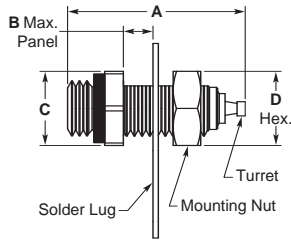

Fig. 1

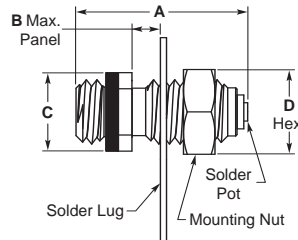
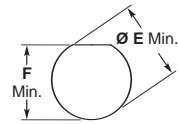

Fig. 2



Mounting Hole for Fig. 1 & 2

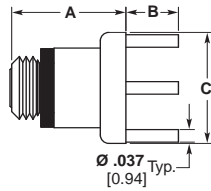

Fig. 3

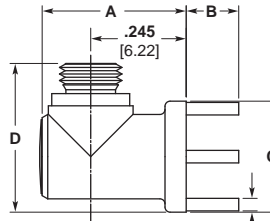
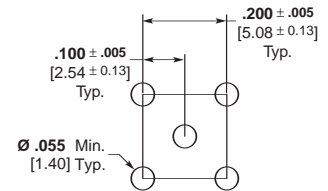

Fig. 4



Mounting Pattern for Fig. 3 & 4

Part No.	Fig.	Dim. A	Dim. B	Dim. C	Dim. D	Dim. E	Dim. F	Special Features
50 Ohm Series .190 [4.83] -32 UNF-2A Thread								
131-0138-0002	1	.605 15.37	.160 4.06	.250 6.35 Hex.	.250 6.35	.191 4.85	.173 4.39	
131-0139-0002	2	.515 13.08	.150 3.81	.187 4.75 Wrench Flats	.250 6.35	.191 4.85	—	No Mounting Flat
131-0140-0001	2	.255 6.48	—	.187 4.75 Wrench Flats	—	.190 4.83 -32 Thd.	—	No Nut or Solder Lug, Threads into Panel
131-0141-0002	3	.340 8.64	.155 3.94	.330 8.38 Dia.	—	—	—	
131-0142-0002	4	.425 10.80	.155 3.94	.330 8.38 Dia.	.480 12.19	—	—	
70 Ohm Series .216 [5.49] -32 UNEF-2A Thread								
131-0202-0002	1	.605 15.37	.160 4.06	.250 6.35 Hex.	.281 7.14	.217 5.51	.197 5.00	
131-0705-0001	3	.340 8.64	.155 3.94	.330 8.38 Dia.	—	—	—	
93 Ohm Series .250 [6.35] -32 UNEF-2A Thread								
131-0303-0002	3	.340 8.64	.155 3.94	.330 8.38 Dia.	—	—	—	
131-0304-0001	4	.425 10.80	.155 3.94	.330 8.38 Dia.	.480 12.19	—	—	
131-0904-0001	1	.605 15.37	.160 4.06	.312 7.92 Hex.	.312 7.92	.251 6.38	.232 5.89	

Gold Plated Crimp Style Coaxial Connectors Assembly Tools

Table 1. Contact Crimp Tools

MICRODOT Part No.	Manufacturers Part No.
010-0065-0000	Astro Tool A-810-3

Table 2. Housing Crimp Tools

MICRODOT Part No.	Thomas & Betts Part No.	Max. Cable Diameter
010-0081-0000	WT-400	.088 [2.24]
010-0082-0000	WT-402	.110 [2.79]
010-0083-0000	WT-406	.155 [3.94]

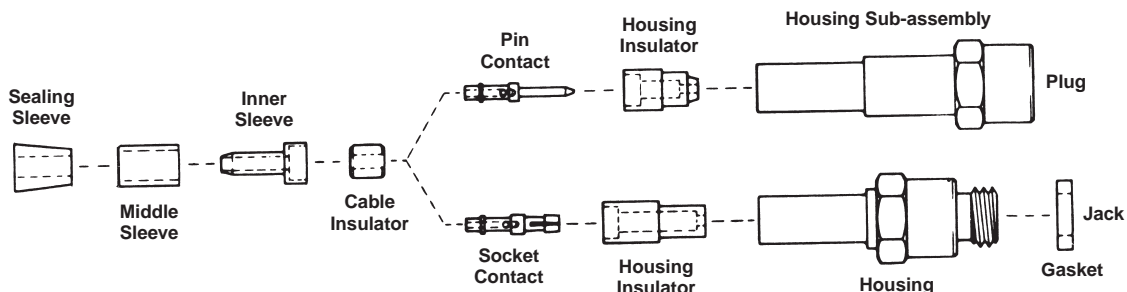

LEPRA/CON Ultra-Miniature Connectors

Performance Data Summary
For LEPRA/CON Connectors

Mechanical

Captive Contacts — Terminated connector contacts captivated from movement in both directions.

Cable Retention — 10 lb. min. when properly assembled to RG196/U and RG178/U cable.

Recommended Coupling Torque (Threaded Interface) — 24 inch/ounces max.

Recommended Receptacle Mounting Torque (All Series) — 24 inch/ounces max.

Typical Cable Acceptance Dimensions — Inner conductor: .012 [0.31] nom. Dielectric: .039 [0.99] max. Shield: .059 [1.50] max. Jacket: .081 [2.06] max.

Contact Protection (Unmated) — Twist pin contact protected from damage by insulator. Tube socket protected by connector housing.

Assembly Methods

Straight Plugs & Jacks — Cable Inner Conductor: Crimped to contact. Cable Shield: Crimped under housing.

Right-Angle Plugs — Cable Inner Conductor: Soldered to contact. Cable Shield: Crimped under housing.

Environmental

Temperature Range (Continuous Service) — -85°F to +392°F [-65°C to +200°C].

Vibration^{1,2} — MIL-STD-202, Method 204, Test Condition B (15 G peaks). No physical damage or electrical discontinuities in excess of 1 microsecond.

Shock^{1,2} — MIL-STD-202, Method 213, Test Condition H. No physical damage or electrical discontinuity after shock.

Thermal Shock — MIL-STD-202, Method 107, Test Condition C.

Moisture Resistance¹ — MIL-STD-202, Method 106.

Salt Spray¹ — MIL-STD-202, Method 101, Test Condition B (48 hours).

Electrical

Impedance — Designed to be compatible with 50 Ohm coaxial cable RG178/U.

Dielectric Withstanding Voltage — 450 volts RMS at sea level, 250 volts RMS at 50,000 ft [15,240 m], 150 volts RMS at 70,000 ft. [21,336 m]

Contact Resistance — 8 milliohms max., D.C.

Contact Capacity — 3 amps, D.C.

Insulation Resistance — 10⁹ Megohms min. @ 500 volts D.C.

Voltage Standing Wave Ratio³ (VSWR) — Typical 50 Ohm Series, 1.2 Maximum to 2 GHz.

Materials

Housing, Nut, Ferrule — Brass per ASTM-B-16.

Insulator — TEFLON per ASTM-D-1710.

Pin & Socket Contact — Copper Alloy.

Crimp Sleeve — Copper Alloy.

Lockwasher — #425 Bronze Alloy.

Plating

Contacts, Housing, Nut, Ferrule, Crimp Sleeve, Lockwasher — Gold per MIL-G-45204, Type II, Grade C, Class 1.

Notes:

¹Screw-On Series, threaded interface.

²Tyco Electronics recommends the use of safety wired connectors in vibration and shock environments. See individual specifications with wire holes.

³VSWR is a system specification. Where performance is critical, purchase Tyco Electronics cable assemblies with Screw-On connectors (See page 129) and specify VSWR testing and mating connector part numbers.

Electronics

LEPRA/CON Ultra-Miniature Connectors — Screw-On Series

Featuring Twist Pin, Pin and Socket Contacts, Standard Interface



MICRODOT twist pin, pin and socket contacts are used in LEPRA/CON connectors. Twist pin contact pins are produced from beryllium copper material with a gold-plated finish and constructed with helically-wound stress free cable of spring copper around a highly conductive soft copper core, terminated with a hemispherical weld. Twist pin

contacts contain seven self-wiping spring surfaces, designed for consistent continuity and very low noise level. Twist pin contacts are self-aligning because of the contact-engaging-end configuration. The sockets are a closed entry tubular-type contact, made of gold-plated copper alloy.

The connectors are designed to be used with coaxial cables RG196/U and RG178/U.

The connectors are designed with the contacts completely protected for reliability. The use of twist pin contacts makes the connectors very rugged for their size.

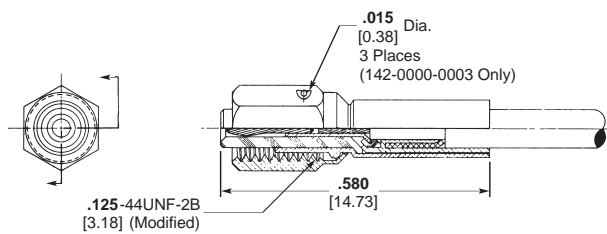

Straight Plugs¹

Part No.	Nut Style
142-0000-0001	.156 [3.96] Hex.
142-0000-0002	.160 [4.06] Dia. Knurl
142-0000-0003	.156 [3.96] Hex. w/ Safety Wire Holes

Assembly instructions: RF-ASMB-12

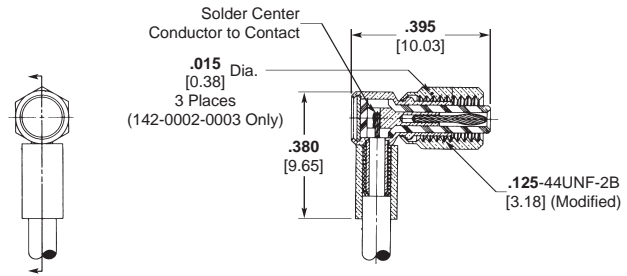

Right-Angle Plug¹

Part No.	Nut Style
142-0002-0001	.156 [3.96] Hex.
142-0002-0002	.160 [4.06] Dia. Knurl
142-0002-0003	.156 [3.96] Hex. w/ Safety Wire Holes

Assembly instructions: RF-ASMB-13

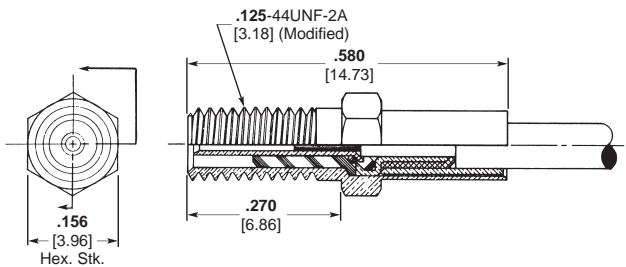

Jack¹

Part Number 141-0000-0001
Instruction Sheet Number 408-08510
Former MICRODOT I.S. Number RF-ASMB-12

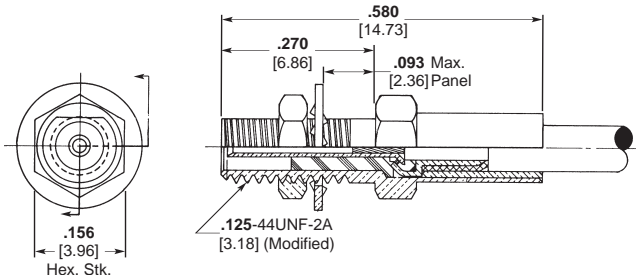

Bulkhead Jack¹

Part Number 141-0001-0001
Instruction Sheet Number 408-08510
Former MICRODOT I.S. Number RF-ASMB-12

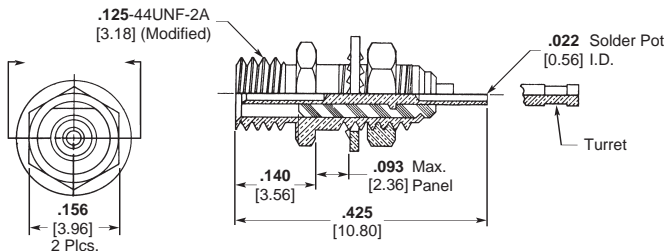

Front Mount Receptacle¹

Part No.	Contact Tail
141-0002-0001	Turret
141-0002-0002	Solder Pot

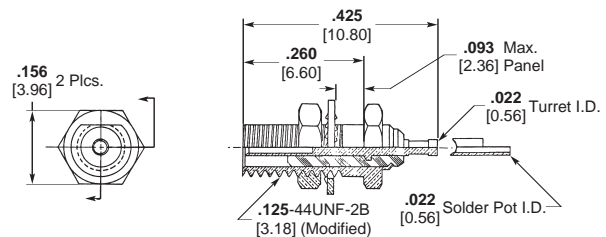

Rear Mount Receptacle¹

Part No.	Contact Tail
141-0003-0001	Turret
141-0003-0002	Solder Pot

¹Mounting hole pattern and assembly tools shown on page 123.

Featuring Twist Pin,
Pin and Socket Contacts,
Standard Interface (Continued)

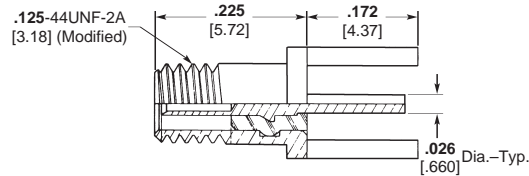

Straight Printed Circuit Receptacle¹
Part No. 141-0004-0001

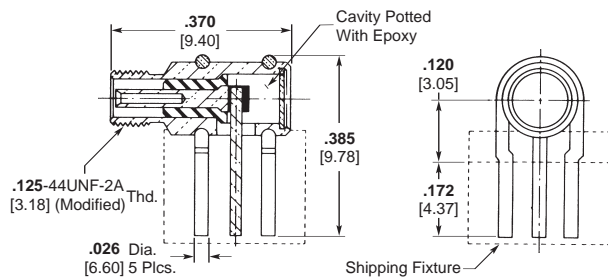

Right-Angle Printed Circuit Receptacle¹
(Small Mounting Pattern)
Part Number 141-0019-0001

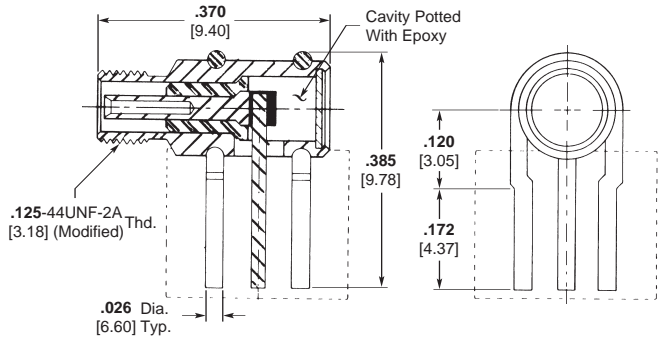

Right-Angle Printed Circuit Receptacle¹
(Standard Mounting Pattern)
Part Number 141-0010-0001

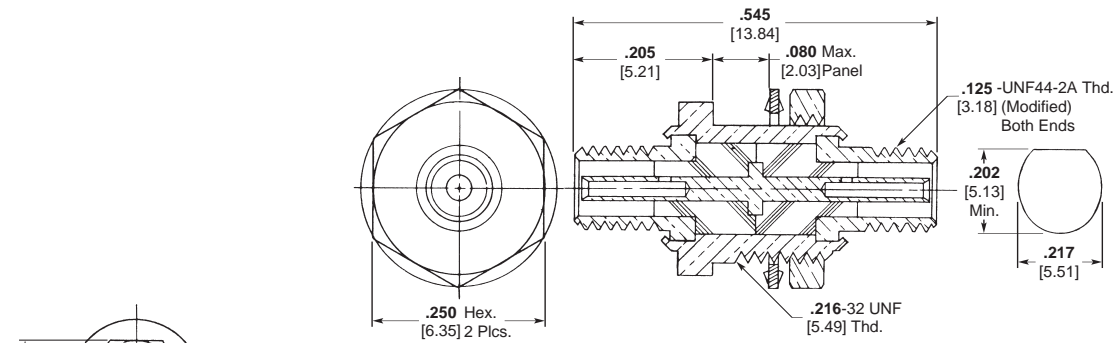

Feed-Thru Bulkhead Adapter
(Both Ends are Receptacle Interface)
Part Number 143-0005-0001

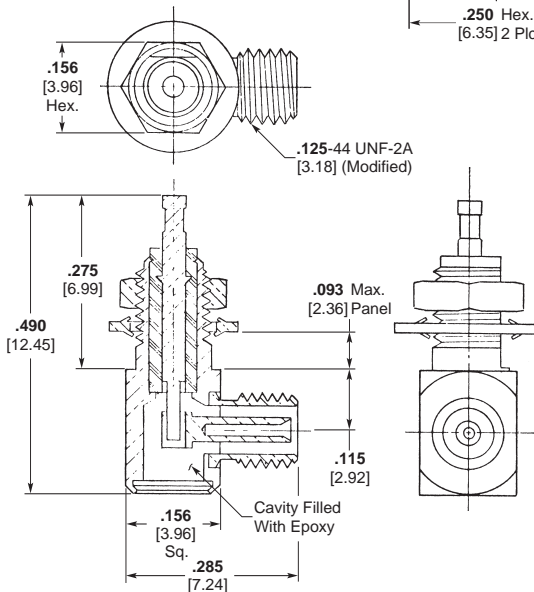

Right-Angle Receptacle¹
Part Number 141-0013-0001



Straight Plug

¹Mounting hole pattern and assembly tools shown on page 123.

LEPRA/CON Ultra-Miniature Connectors — Screw-On Series (Continued)

Featuring Twist Pin, Pin and Socket Contacts with Locking Interface

The MICRODOT LEPRA/CON coaxial connector series is now offered with a unique locking interface feature. This new coupling design permits the user to lock the coaxial plug, when mated to its receptacle, preventing any axial rotation. This

adaptation is especially popular on connector installations requiring straight or 90° cable terminations firmly held in a fixed position. The locking interface is especially suited for telecommunications and instrumentation applications. This

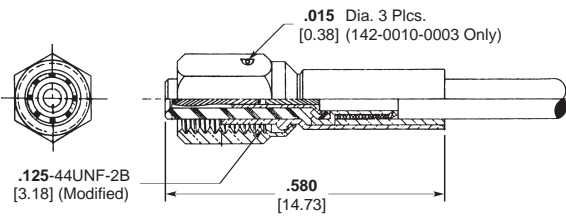

Straight Plug¹

Part No.	Nut Style
142-0010-0001	.156 [3.96] Hex.
142-0010-0002	.160 [4.06] Dia. Knurl
142-0010-0003	.156 [3.96] Hex. w/ Safety Wire Holes

Assembly instructions: RF-ASMB-12, 142-0010-0001

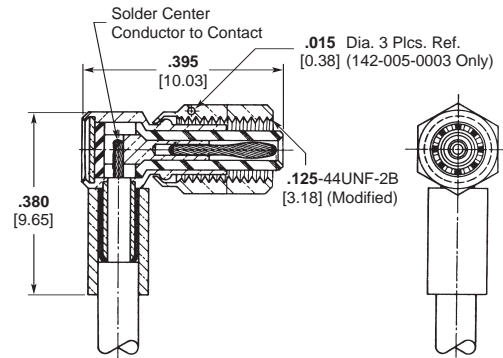

Right-Angle Plug¹

Part No.	Nut Style
142-0005-0001	.156 [3.96] Hex.
142-0005-0002	.160 [4.06] Dia. Knurl
142-0005-0003	.156 [3.96] Hex. w/ Safety Wire Holes

Assembly instructions: RF-ASMB-13, 142-0005-0001

¹Assembly tools; page 123.

Featuring Twist Pin,
Pin and Socket Contacts
with Locking Interface

(Continued)

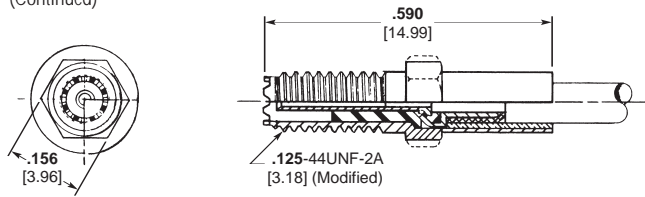

Straight Jack¹
Part Number 141-0017-0001
Instruction Sheet Number 408-08510
Former MICRODOT I.S. Number RF-ASMB-12

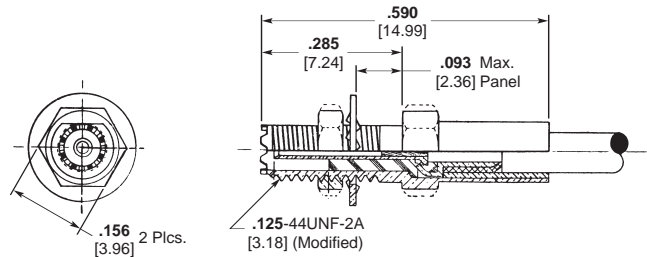

Bulkhead Jack¹
Part Number 141-0014-0001
Instruction Sheet Number 408-08510
Former MICRODOT I.S. Number RF-ASMB-12

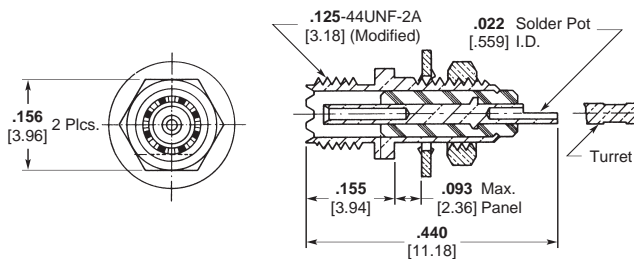

Front Mount Receptacle¹

Part No.	Contact Tail
141-0012-0001	Solder Pot
141-0012-0002	Turret

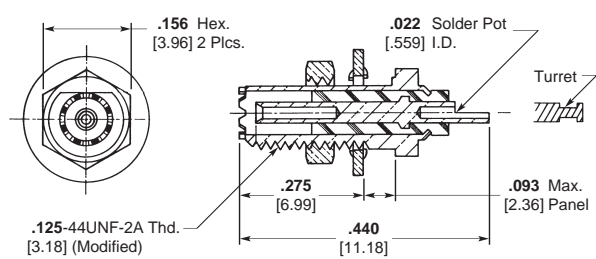

Rear Mount Receptacle w/ Locking Interface¹

Part No.	Contact Tail
141-0011-0001	Turret
141-0011-0002	Solder Pot

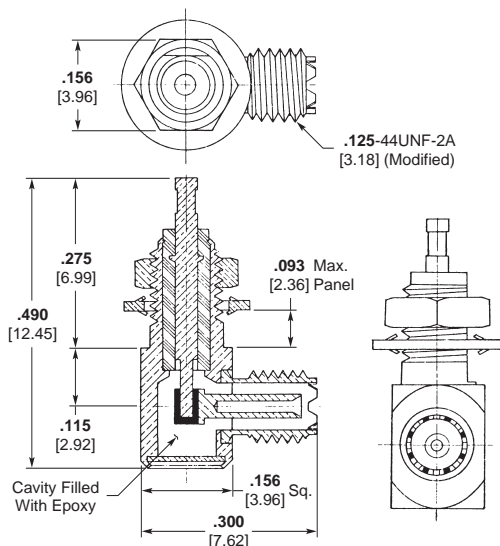

Right-Angle Receptacle¹
Part Number 141-0020-0001

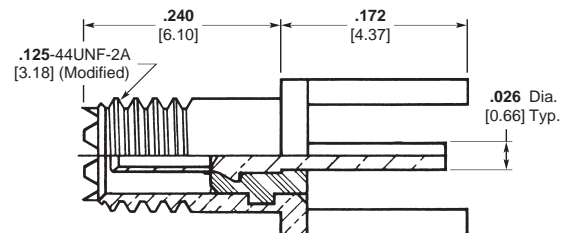

Straight Printed Circuit Receptacle¹
Part Number 141-0015-0001

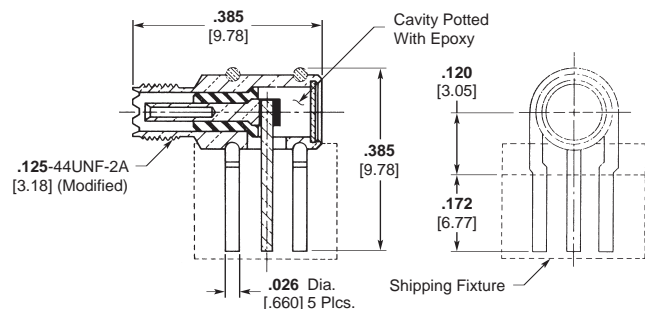

Right-Angle Printed Circuit Receptacle¹
Part Number 141-0023-0001

¹Mounting hole pattern and assembly tools shown on page 123.

Featuring Twist Pin,
Pin and Socket Contacts



LEPRA/CON Slide-On Connectors offer a convenient mating style along with Ultra-miniature size. Inner contacts are twist pin tubular sockets in plugs and twist pin contacts for jacks and receptacles. Positive housing contact is provided by a three finger contact in the plug housing.

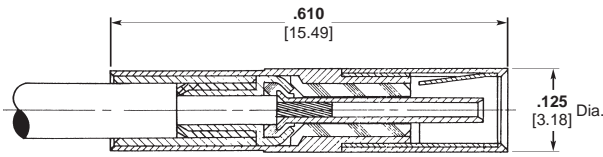

Straight Plug¹
Part Number 142-1000-0001
Instruction Sheet Number 408-08512
Former MICRODOT I.S. Number RF-ASMB-15

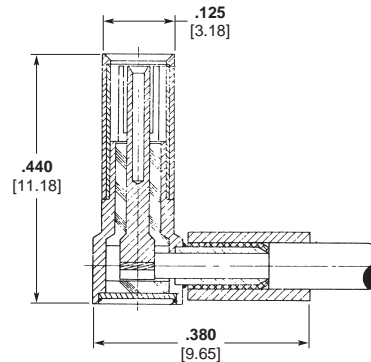
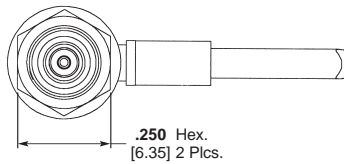

Right-Angle Plug¹
Part Number 142-1002-0001
Instruction Sheet Number 408-08513
Former MICRODOT I.S. Number RF-ASMB-16

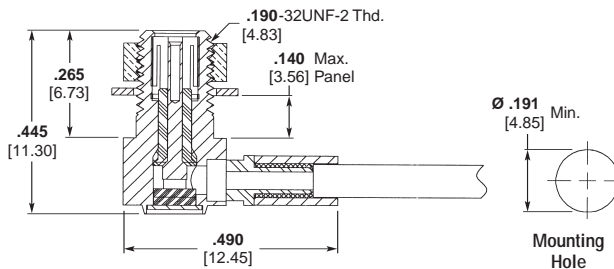

Right-Angle Bulkhead Mount Plug¹
Part Number 142-1021-0001
Instruction Sheet Number 408-08519
Former MICRODOT I.S. Number RF-ASMB-76

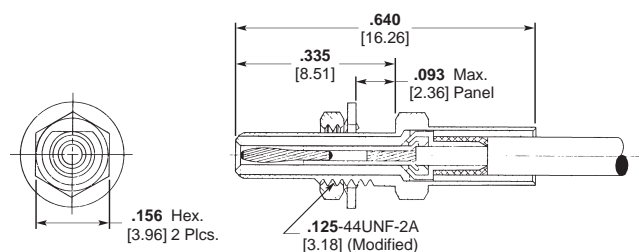

Straight Bulkhead Jack¹
Part Number 141-1001-0001
Instruction Sheet Number 408-08512
Former MICRODOT I.S. Number RF-ASMB-15

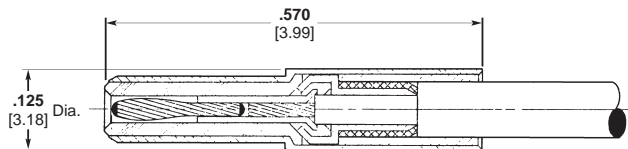

Straight Jack¹
Part Number 141-1000-0001
Instruction Sheet Number 408-08512
Former MICRODOT I.S. Number RF-ASMB-15

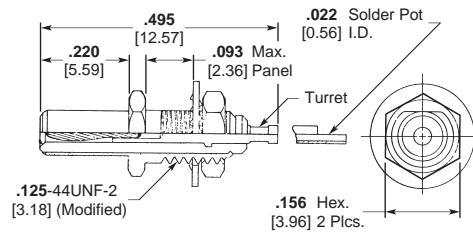

Front Mount Receptacle¹

Part No.	Contact Tail
141-1002-0001	Turret
141-1002-0002	Solder Pot

¹Mounting hole and assembly tools shown on page 123.

Featuring Twist Pin, Pin and Socket Contacts

(Continued)

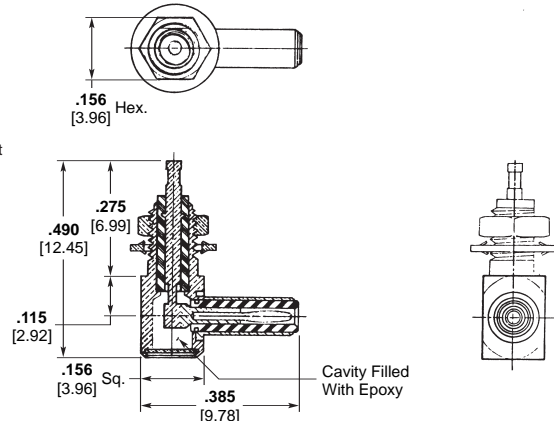
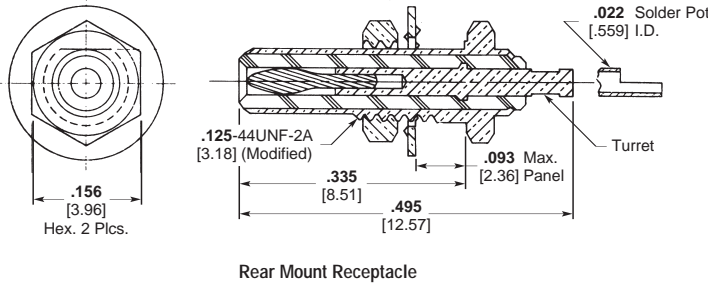

Part No.	Contact Tail
141-1003-0001	Turret
141-1003-0002	Solder Pot

Mounting Hole shown below.

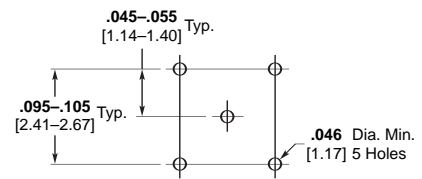
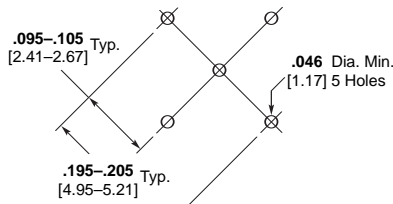
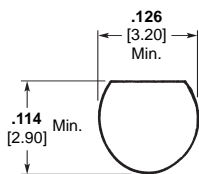
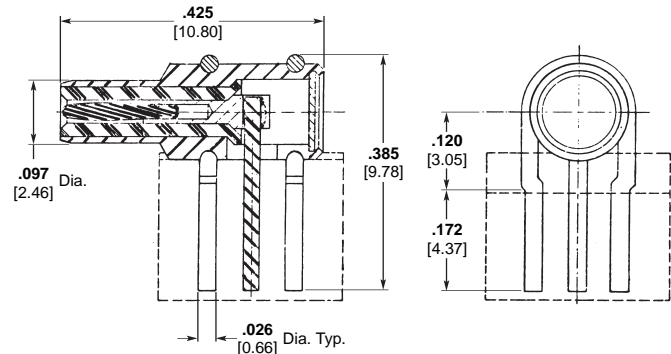
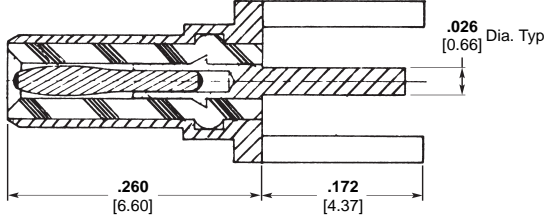

Printed Circuit Receptacle Mounting Hole Pattern

LEPRA/CON Connector Assembly Tools



Housing Crimp Tool



Contact Crimp Tool

MICRODOT Part No.	Thomas & Betts Part No.
010-0132-0000	WT-419

Connector	Contact Crimp No.	Astro Tool Part No.
Straight Connector Only	010-0150-0000	A-826-1
141-1001-0001	010-0161-0000	827

BNC / LEPRA/CON Connector Adapters

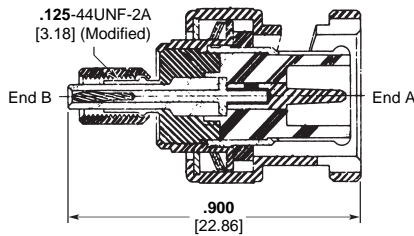

End "B" is MICRODOT Screw-On Plug
End "A" is BNC Plug
Part Number 143-0001-0001

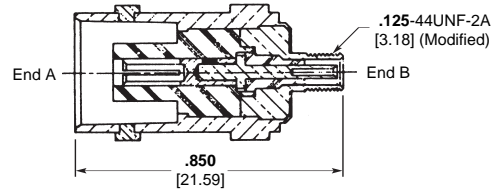

End "A" is BNC Receptacle
End "B" is MICRODOT Screw-On Receptacle
Part Number 143-0003-0001

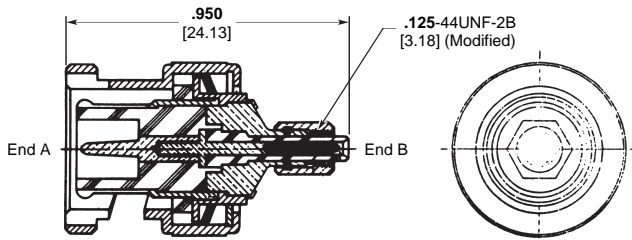

End "A" is BNC Plug
End "B" is MICRODOT Screw-On Plug with Locking Interface
Part Number 143-0029-0001

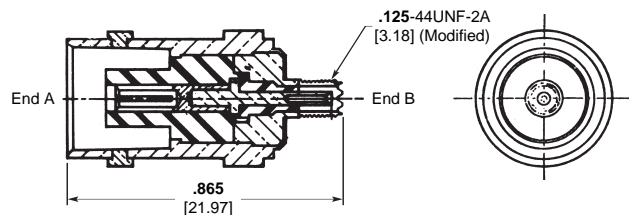

End "A" is BNC Receptacle
End "B" is MICRODOT Screw-On Receptacle with Locking Interface
Part Number 143-0032-0001

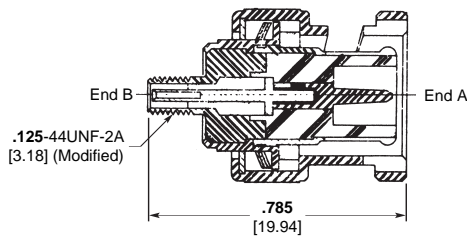

End "B" is Screw-On Receptacle
End "A" is BNC Plug
Part Number 143-0002-0001

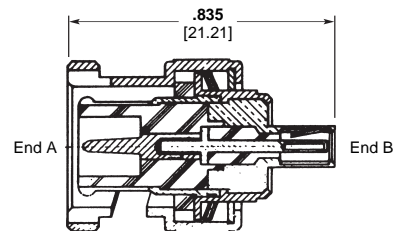

End "A" is BNC Plug
End "B" is MICRODOT Slide-On Plug
Part Number 143-1000-0001

BNC / LEPRA/CON Connector Adapters

(Continued)

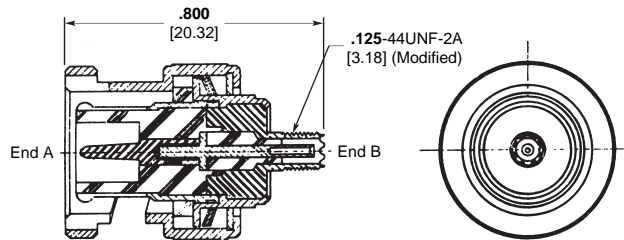

End "A" is BNC Plug End "B" is MICRODOT Receptacle with Locking Interface
Part Number 143-0031-0001

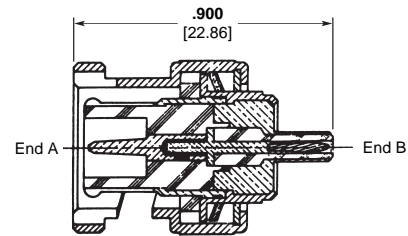

End "A" is BNC Plug End "B" is MICRODOT Slide-On Receptacle
Part Number 143-1002-0001

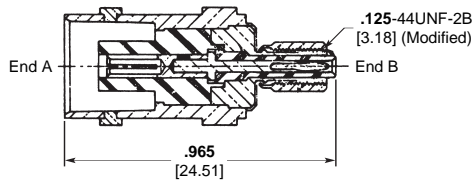

End "A" is BNC Receptacle End "B" is MICRODOT Screw-On Plug
Part Number 143-0004-0001

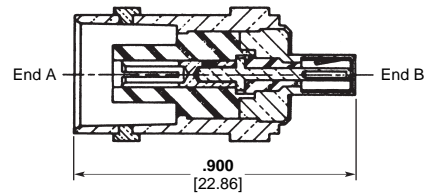

End "A" is BNC Receptacle End "B" is MICRODOT Slide-On Plug
Part Number 143-1001-0001

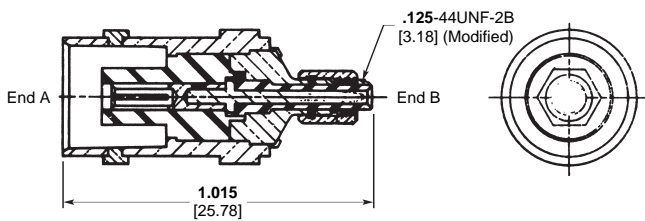

End "A" is BNC Receptacle End "B" is MICRODOT Screw-On Plug with Locking Interface
Part Number 143-0030-0001

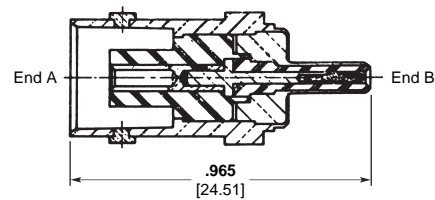

End "A" is BNC Receptacle End "B" is MICRODOT Slide-On Receptacle
Part Number 143-1003-0001

Electronics

LEPRA/CON Ultra-Miniature Connectors — Snap-Lock Series

Product Facts

- Simple coupling design eliminates the need for tools and saves assembly time
- Positive locking mechanism provides its own fail-safe features
- Inspection of the mated connector is fast, simple and effective
- Push-Pull design allows higher panel density
- Quick-connect and disconnect features

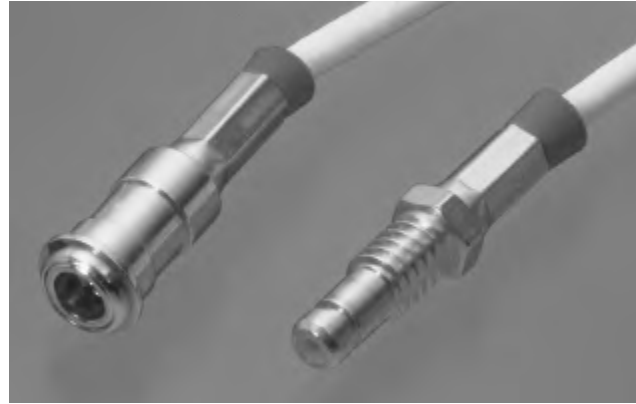

Performance Data Summary
For Snap-Lock Connectors

Electrical

Impedance — Designed to be compatible with 50 Ohm coaxial cables (Dual Shield RG 196).
Dielectric Withstanding Voltage — 450 volts RMS at sea level (Operating).
Contact Resistance — 8 milliohms max. at 3 amps. Average resistance: 4 milliohms
Insulation Resistance — 10⁴ megohms min.
Voltage Standing Wave Ratio (VSWR) — 3.4 max., 1.3 min. to 12 GHz.

Environmental

Temperature Range — -85°F to +257°F [-65°C to +125°C].
Vibration — MIL-STD-202, Method 204, Test condition D. No change in electrical discontinuity in excess of 1 microsecond.
Shock — MIL-STD-202, Method 213A, Test Condition C. No electrical discontinuity or evidence of physical damage.
Mechanical
Cable Acceptance Dimensions — Center conductor: .012 [0.31] nom. Dielectric: .040 [1.02] max. Shield: .080 [2.03] max. Jacket: .090 [2.29] max..

All-Crimp Assembly —

Center contacts and shield are crimped individually.
Durability — 500 mating cycles.
Materials
Body and Body Components — Brass per QQ-B-626 Comp 360.
Contact Material — Copper Alloy.
Crimp Sleeves — Leaded Copper.
Insulators — TEFLON per ASTM-D-1710.
Lockwashers — #425 Bronze Alloy.
Plating — Gold per MIL-G-45204, Type II, Grade C, Class 1.

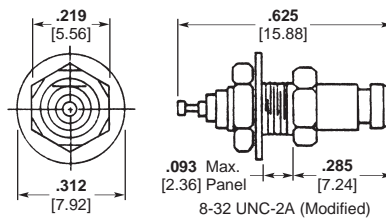
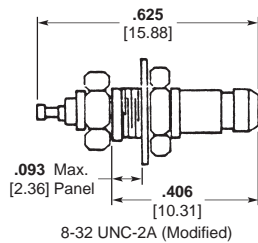
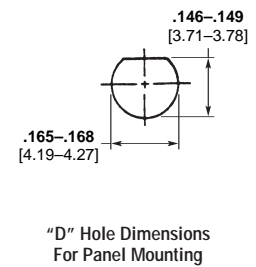
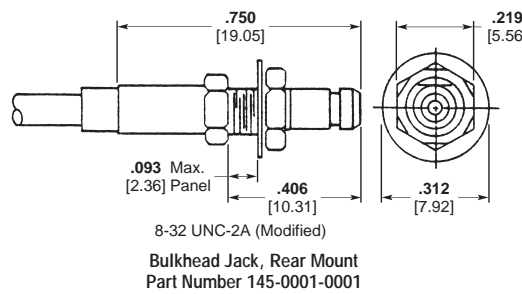
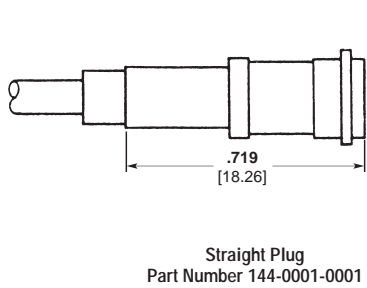

Connector/Cable Assembly Crimp Tools — Center Contact and Shield

Tool	Part No.
SKT & Pin Crimp	010-1004-0000
Housing Crimp	010-0081-0000

Cable Assemblies

Capability

The experience Tyco Electronics has gained through years of pioneering efforts in the development of MICRODOT miniaturized cable and connectors is available to customers in the assembly of complex cable/connector combinations. This experience offers the customer low cost and

no tooling charges, precision construction, thorough inspection and prompt delivery. The capability also makes it possible for the designer to specify a complete assembly or harness with the understanding that Tyco Electronics will deliver a custom fabrication equal in quality to the MICRODOT

components it contains. These assemblies are made to the customer's specifications or are designed by the Company's experienced engineers to fit particular requirements. Special features are light weight, reduced size, high operating temperatures and comprehensive layouts.

How To Order

1. Specify MICRODOT part numbers
 - A. Connector, one end
 - B. Connector, other end
 - C. Cable

2. Specify normal length
 - A. Overall length

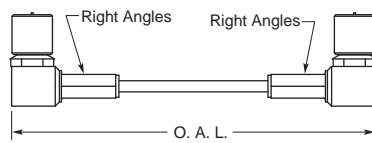
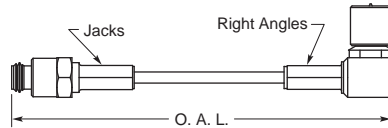

- B. Or length between connectors

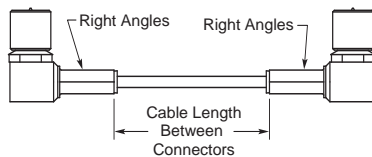
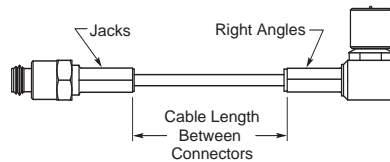
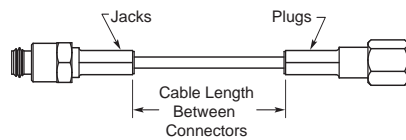

3. Specify length tolerance

- A. Standard tolerance

Assembly Length	Tolerance
0 thru 12-1/2"	±1/8"
Over 12-1/2" thru 1000"	±1% rounded to nearest 1/4"
Over 1000"	±1% rounded to nearest 1"

- B. Special tolerance

Tolerances as close as ±.5% are available for most cable assemblies at a premium rate. Consult Tyco Electronics for details.

4. Specify cable strip (Applies to cable assemblies with only one connector)

- A. Not stripped
- B. Standard strip

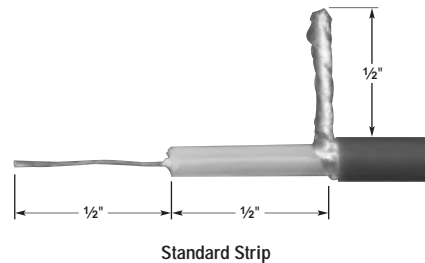

- C. Special strip - specify style

Example:

Connector:
142-1000-0001 one end
142-1002-0001 other end

Length:
36" overall, standard tolerance

Mating Interface Chart

Plugs			Jacks and Receptacles		
Series	Description	Page	Series	Description	Page
S50	Standard	94, 95	S50	Standard	96, 97
50 Ohm	Gold Plated Crimp Style	113, 114	50 Ohm	Gold Plated Crimp Style	115, 116
50 Ohm	Cap	109	50 Ohm	Feed Thru Adapter	110, 111
S70	Standard	94, 95	S70	Standard	96, 97
70 Ohm	Gold Plated Crimp Style	113, 114	70 Ohm	Gold Plated Crimp Style	115, 116
70 Ohm	Cap	109	70 Ohm	Feed Thru Adapter	110, 111
S93	Standard	94, 95	S93	Standard	96, 98
93 Ohm	Gold Plated Crimp Style	114	93 Ohm	Gold Plated Crimp Style	115, 116
93 Ohm	Cap	109	93 Ohm	Feed Thru Adapter	110, 111
SOS 50	Standard	99, 100	SOS 50	Standard	99, 102
SOS 70	Standard	100, 101	SOS 70	Standard	101, 102
SOS 93	Standard	100, 101	SOS 93	Standard	101, 102
QC 50	Standard	103, 104	QC 50	Standard	103
QC 70	Standard	104	QC 70	Standard	103
QC 93	Standard	104	QC 93	Standard	103
Screw-On	Twinax	106	Screw-On	Twinax	106
Slide-On	Twinax	106	Slide-On	Twinax	106
Screw-On	Triax	107	Screw-On	Triax	107
Screw-On	LEPRA/CON Connector	118	Screw-On	LEPRA/CON Connector	118, 119
Screw-On	LEPRA/CON Connector Interlocking Interface	120	Screw-On	LEPRA/CON Connector Interlocking Interface	121
Slide-On	LEPRA/CON Connector	122	Slide-On	LEPRA/CON Connector	122, 123

Cable Acceptance Dimensions

Connector Part No.	Max. Jacket	Max. Shield	Max. Dielectric	Max. Inner Conductor
S-50				
032-0021-0001	.087 2.21	.061 1.55	.050 1.27	.013 .330
032-0023-0001	.087 2.21	.061 1.55	.041 1.04	.015 .381
032-0025-0001	.093 2.36	.068 1.73	.050 1.27	.013 .330
032-0033-0001	.093 2.36	.077 1.96	.047 1.00	.015 .381
032-0097-0001	.087 2.21	.061 1.55	.050 1.27	.015 .381
032-0098-0001	.087 2.21	.061 1.55	.041 1.04	.015 .381
032-0155-0001	.088 2.24	.061 1.55	.041 1.04	.015 .381
032-0156-0001	.088 2.24	.061 1.55	.041 1.04	.015 .381
052-0213-0001	.087 2.21	.061 1.55	.050 1.27	.013 .330
052-0235-0001	.087 2.21	.061 1.55	.041 1.04	.015 .381
052-0235-0003	.087 2.21	.061 1.55	.041 1.04	.015 .381
052-0370-0001	.093 2.36	.068 1.73	.041 1.04	.015 .381
052-0542-0001	.087 2.21	.061 1.55	.041 1.04	.015 .381
S-70				
032-0010-0001	.093 2.36	.075 1.91	.061 1.55	.013 .330
032-0022-0001	.093 2.36	.075 1.91	.059 1.50	.015 .381
032-0067-0001	.108 2.74	.079 2.01	.059 1.50	.015 .381
032-0078-0001	.108 2.74	.079 2.01	.061 1.55	.013 .330
032-0222-0001	.093 2.36	.075 1.91	.059 1.50	.015 .381
052-0092-0001	.093 2.36	.075 1.91	.059 1.50	.015 .381
S-93				
032-0011-0001	.134 3.40	.118 2.99	.100 2.54	.013 .330
032-0017-0001	.134 3.40	.118 2.99	.100 2.54	.015 .381
032-0066-0001	.154 3.91	.118 2.99	.101 2.67	.015 .381
032-0071-0001	.134 3.40	.118 2.99	.097 2.446	.031 .787
032-0092-0001	.155 3.94	.125 3.18	.107 2.72	.015 .381
032-0099-0001	.134 3.40	.118 2.99	.100 2.54	.015 .381
052-0200-0001	.134 3.40	.118 2.99	.100 2.54	.015 .381

Cable Acceptance Dimensions (Continued)

Connector Part No.	Max. Jacket	Max. Shield	Max. Dielectric	Nom. Inner Conductor
S-50				
032-0015-0001	.092 2.34	.060 1.52	Any	.012 .305
052-0204-0001	.092 2.34	.060 1.52	Any	.012 .305
052-0215-0001	.092 2.34	.060 1.52	Any	.012 .305
052-0337-0001	.111 2.81	.074 1.88	Any	.012 .305
S-70				
032-0013-0001	.111 2.81	.074 1.88	Any	.012 .305
052-0299-0001	.111 2.81	.074 1.88	Any	.012 .305
052-0379-0001	.111 2.81	.074 1.88	Any	.012 .305
S-93				
032-0014-0001	.134 3.40	.123 3.12	Any	.012 .305
032-0068-0001	.155 3.94	.118 2.99	Any	.012 .305
032-0153-0001	.155 3.94	.118 2.99	Any	.012 .305
052-0207-0001	.134 3.40	.123 3.12	Any	.012 .305
052-0298-0001	.134 3.40	.123 3.12	Any	.012 .305
052-0304-0022	.155 3.94	.118 2.99	Any	.012 .305

Connector Part No.	Max. Jacket	Max. Shield	Max. Dielectric	Max. Inner Conductor
S-50				
031-0033-0001	.088 2.24	.061 1.55	.041 1.04	.021 .533
031-0034-0001	.087 2.21	.061 1.55	.041 1.04	.021 .533
051-0467-0001	.079 2.01	.061 1.55	.041 1.04	.021 .533
S-70				
031-0036-0001	.093 2.36	.075 1.91	.059 1.50	.021 .533
031-0048-0001	.093 2.36	.075 1.91	.059 1.50	.021 .533
031-0090-0001	.109 2.77	.079 2.01	.059 1.50	.021 .533
S-93				
031-0032-0001	.134 3.40	.118 2.99	.100 2.54	.021 .533
031-0037-0001	.134 3.40	.118 2.99	.100 2.54	.021 .533
031-0088-0001	.154 3.91	.118 2.99	.101 2.57	.021 .533
031-0089-0001	.154 3.91	.118 2.99	.101 2.57	.021 .533

Slide-On Series
Straight Plugs — Page 100

Cable Acceptance Dimensions (Continued)

Connector Part No.	Max. Jacket	Max. Shield	Max. Dielectric	Max. Inner Conductor
SOS-50				
032-0055-0001	.088 2.24	.058 1.47	.041 1.04	.015 .381
032-0056-0001	.088 2.24	.058 1.47	.041 1.04	.015 .381
SOS-70				
032-0060-0001	.093 2.36	.075 1.71	.059 1.50	.015 .381
032-0061-0001	.093 2.36	.075 1.71	.059 1.50	.015 .381
032-0087-0001	.108 2.74	.079 2.01	.059 1.50	.015 .381
SOS-93				
032-0058-0001	.134 3.40	.118 2.99	.100 2.54	.015 .381
032-0077-0001	.134 3.40	.118 2.99	.100 2.54	.015 .381
032-0084-0001	.154 3.91	.118 2.99	.101 2.57	.015 .381

Right-Angle Plugs — Page 101

Connector Part No.	Max. Jacket	Max. Shield	Max. Dielectric	Nom. Inner Conductor
SOS-50				
032-0063-0001	.092 2.34	.060 1.52	Any	.012 .305
SOS-70				
032-0062-0001	.111 2.82	.074 1.88	Any	.012 .305
SOS-93				
032-0059-0001	.134 3.40	.123 3.12	Any	.012 .305
032-0083-0001	.155 3.94	.118 2.99	Any	.012 .305

Jacks — Page 101

Connector Part No.	Max. Jacket	Max. Shield	Max. Dielectric	Max. Inner Conductor
SOS-50				
031-0053-0001	.088 2.24	.061 1.55	.041 1.04	.021 .533
031-0054-0001	.088 2.24	.061 1.55	.041 1.04	.021 .533
SOS-70				
031-0095-0001	.108 2.74	.079 2.01	.059 1.50	.021 .533
SOS-93				
031-0063-0001	.134 3.40	.118 2.99	.100 2.54	.021 .533
031-0064-0001	.134 3.40	.118 2.99	.100 2.54	.021 .533
031-0093-0001	.154 3.91	.118 2.99	.101 2.57	.021 .533
031-0094-0001	.154 3.91	.118 2.99	.101 2.57	.021 .533

Quick-Connect Series
Straight Plugs — Page 104

Cable Acceptance Dimensions (Continued)

Connector Part No.	Max. Jacket	Max. Shield	Max. Dielectric	Max. Inner Conductor
QC-50				
032-0002-0001	.093 2.36	.058 1.47	Any	.013 .330
032-0030-0001	.093 2.36	.058 1.47	.041 1.04	.015 .381
QC-70				
032-0016-0001	.093 2.36	.075 1.91	.061 1.55	.013 .330
032-0031-0001	.093 2.36	.075 1.71	.059 1.50	.015 .381
032-0079-0001	.108 2.74	.079 2.01	.059 1.50	.015 .381
QC-93				
032-0012-0001	.134 3.40	.118 2.99	.100 2.54	.013 .330
032-0032-0001	.134 3.40	.118 2.99	.100 2.54	.015 .381
032-0072-0001	.154 3.91	.118 2.99	.101 2.57	.015 .381

Right-Angle Plugs — Page 104

Connector Part No.	Max. Jacket	Max. Shield	Max. Dielectric	Nom. Inner Conductor
QC-50				
032-0026-0001	.092 2.34	.060 1.52	Any	.012 .305
QC-70				
032-0027-0001	.111 2.82	.074 1.88	Any	.012 .305
QC-93				
032-0020-0001	.134 5.40	.123 3.12	Any	.012 .305
052-0228-0001	.155 3.94	.118 2.99	Any	.012 .305

Jacks — Page 105

Connector Part No.	Max. Jacket	Max. Shield	Max. Dielectric	Max. Inner Conductor
QC-50				
031-0038-0001	.093 2.36	.061 1.55	.041 1.04	.021 .533
QC-93				
031-0040-0001	.134 3.40	.118 2.99	.100 2.54	.021 .533

Twinax Plugs — Page 106

Connector Part No.	Max. Jacket	Max. Shield	Max. Dielectric	Max. Inner Conductor
032-0088-0001	.167 4.24	.142 3.60	.061 1.55	.014 .356
032-0093-0001	.123 3.12	.092 2.34	.042 1.07	.014 .356
052-0229-0001	.123 3.12	.092 2.34	.042 1.07	.014 .356
052-0324-0001	.167 4.24	.142 3.61	.061 1.55	.014 .356

Jacks — Page 106

Connector Part No.	Max. Jacket	Max. Shield	Max. Dielectric	Max. Inner Conductor
051-0358-0001	.167 4.24	.142 3.60	.061 1.55	.020 .508
051-0389-0001	.167 4.24	.142 3.61	.061 1.55	.020 .508

Triax
Plugs — Page 107

Cable Acceptance Dimensions (Continued)

Connector Part No.	Max. Jacket	Max. Outer Shield	Max. Outer Dielectric	Max. Inner Shield	Max. Inner Dielectric	Max. Inner Conductor
052-0130-0001	.124 3.15	Single Shield	.085 2.26	Single Shield	.041 1.04	.014 .356
052-0138-0001	.183 4.65	Single Shield	.146 3.71	.118 2.99	.107 2.72	.014 .356
052-0593-0001	.214 5.44	Single Shield	.166 4.22	.161 4.09	.131 3.33	.020 .508

Gold Plated Crimp Style
Coaxial Connectors
Straight Plugs — Pages 113, 114

Connector Part No.	Max. Jacket	Max. Dielectric	Nom. Inner Conductor
50 Ohm Series			
132-0112-000*	.088 2.24	.039 .991	.012 .305
132-0113-000*	.088 2.24	.039 .991	.012 .305
132-0114-000*	.110 2.79	.070 1.78	.012 .305
132-0115-000*	.110 2.79	.070 1.78	.012 .305
132-0509-0002	.116 2.95	.070 1.78	.012 .305
70 Ohm Series			
132-0200-000*	.110 2.79	.070 1.78	.012 .305
132-0201-000*	.110 2.79	.070 1.78	.012 .305
93 Ohm Series			
132-0300-000*	.155 3.94	.107 2.72	.012 .305
132-0301-000*	.155 3.94	.107 2.72	.012 .305

Right-Angle Plugs — Page 114

Connector Part No.	Max. Jacket	Max. Dielectric	Nom. Inner Conductor
50 Ohm Series			
132-0116-0002	.088 2.24	.039 .991	.012 .305
132-0117-0002	.088 2.24	.039 .991	.012 .305
132-0118-0002	.110 2.79	.074 1.88	.012 .305
132-0119-0002	.110 2.79	.074 1.88	.012 .305
70 Ohm Series			
132-0202-0002	.110 2.79	.074 1.88	.012 .305
132-0203-0002	.110 2.79	.074 1.88	.012 .305
93 Ohm Series			
132-0302-0002	.155 3.94	.107 2.72	.012 .305
132-0303-0002	.155 3.94	.107 2.72	.012 .305

Gold Plated Crimp Style Coaxial Connectors (Continued)

Jacks — Page 115

LEPRA/CON Connectors

All — Pages 118-126

Cable Acceptance Dimensions (Continued)

Connector Part No.	Max. Jacket	Max. Dielectric	Nom. Inner Conductor
50 Ohm Series			
131-0134-0001	.088 2.24	.039 .991	.012 .305
131-0135-0001	.088 2.24	.039 .991	.012 .305
131-0136-0001	.110 2.79	.070 1.78	.012 .305
131-0137-0001	.110 2.79	.070 1.78	.012 .305
70 Ohm Series			
131-0200-0001	.110 2.79	.070 1.78	.012 .305
131-0201-0001	.110 2.79	.070 1.78	.012 .305
93 Ohm Series			
131-0300-0001	.155 3.94	.107 2.72	.012 .305
131-0301-0001	.155 3.94	.107 2.72	.012 .305

Connector Part No.	Max. Jacket	Max. Dielectric	Nom. Inner Conductor
All	.081 2.06	.040 1.02	.012 .305

Coaxial Screw-On, Slide-On Series

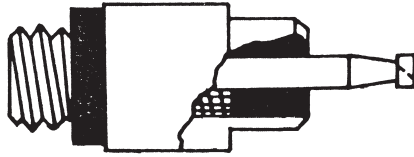

Material and Finish

50 Connector uses 10-32 thread.
 70 Connector uses 12-32 thread.
 93 Connector uses 1/4-32 thread.
Housing (1) — Cold rolled steel silver plate.
Gasket (2) — Neoprene or silicone rubber.
Insulator (3) — TEFLON.
Glass Seal (4)
Center Contact (5) — Nickel Iron alloy contact with slotted turret type solder pot (other terminations available).

Service and Performance Data

Temperature Range — -65°F to 450°F [-54°C to 232°C].
Electrical — 750 VAC working voltage.
Performance — 1200 VAC test at sea level.
Insulation Resistance — 5000 megohms at 500 VDC (room temperature).
Shock — 100 G's minimum.
Pressure — 100 PSI minimum.
Leak Rate Per Seal — Less than 1.04 x 10⁻⁸ cc/sec. (.001 Micron cubic ft/hr) of 100% helium tested at one atmosphere pressure differential far exceeding requirements of MIL-C-26500 and MIL-C-26482.
Plating — Silver unless otherwise specified.

Bulkhead Solder Mount

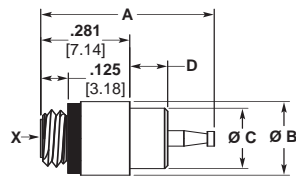

Fig. 1

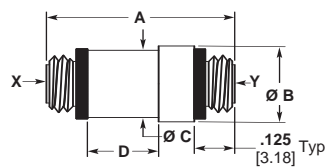

Fig. 2

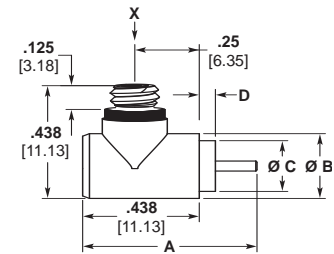

Fig. 3

Part No.	Fig.	A	B Dia.	C Dia. ±.015	D	X*	Y*
051-0049-0001	1	.563 14.30	.25 6.35	.200 5.08	.125 3.18	S-50	—
051-0056-0001	1	.563 14.30	.313 7.95	.251 6.38	.125 3.18	S-93	—
053-0228-0001	2	.594 15.09	.25 6.35	.227 5.77	.234 5.94	S-50	S-50
051-0315-0001	3	.656 16.66	.25 6.35	.195 4.95	.063 1.60	S-50	—

* "S" indicates Screw-On Series
 Dimensions are subject to change without notice.

Bulkhead Solder Mount, Panel Insulated

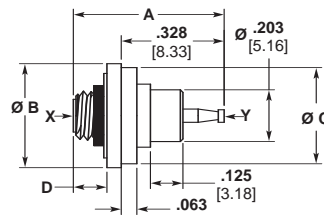

Fig. 1

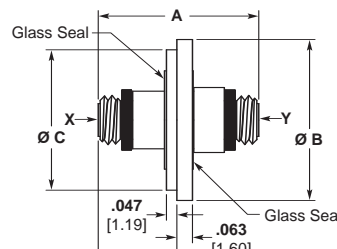

Fig. 2

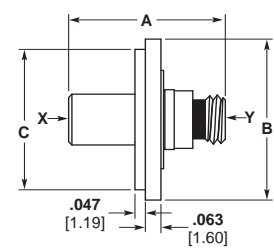

Fig. 3

Part No.	Fig.	A	B Dia.	C Dia.	D	X*	Y*
051-0232-0001	1	.563 14.30	.406 10.31	.370 9.40	.172 4.37	S-50	—
053-0227-0001	2	.609 15.47	.625 15.88	.540 13.72	.297 7.54	S-50	S-50
053-0412-0001	2	.609 15.47	.625 15.88	.540 13.72	.297 7.54	S-93	S-93
053-0028-0001	3	.609 15.47	.625 15.88	.540 13.72	.297 7.54	SOS-50	S-50

* "S" indicates Screw-On Series; "SOS" indicates Slide-On Series
 Dimensions are subject to change without notice.

Coaxial Screw-On, Slide-On Series

(Continued)

Microminiature Coaxial Receptacles

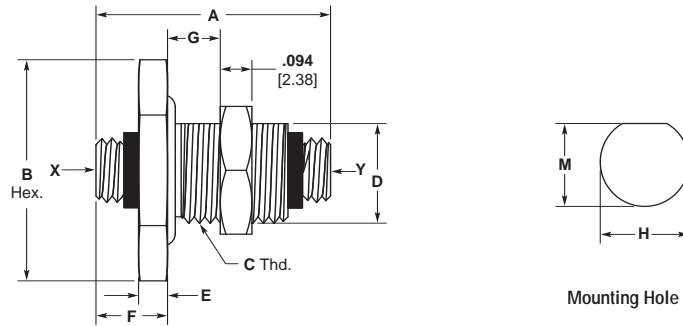

Part No.	A	B Hex.	C Thd.	D	E	F	G	H	M	X*	Y*
053-0455-0001	.688 17.46	.563 14.29	5/16-32 UNEF-2A	.297 7.54	.094 2.38	.203 5.16	.25 6.35	.312 7.92	.291 7.39	S-50	S-50
053-0636-0001	.922 23.42	.625 15.88	3/8-32 UNEF-2A	.344 8.73	.078 1.98	.203 5.16	.438 11.11	.375 9.53	.347 8.81	S-93	S-93

* "S" indicates Screw-On Series
Dimensions are subject to change without notice.

Solder Mount Slide-On Series Receptacles

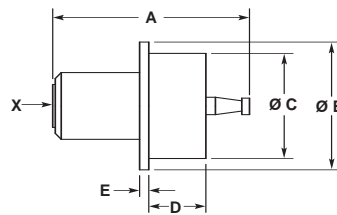

Part No.	A	B Dia.	C Dia. ±.015	D	E	X*
051-0134-0001	.563 14.29	.375 9.53	.309 7.85	.172 4.37	.031 .794	SOS-50, 70, 93
051-0158-0001	.563 14.29	.25 6.35	.200 5.08	.125 3.18	.047 1.19	SOS-50, 70, 93

* "SOS" indicates Slide-On Series
Dimensions are subject to change without notice.

Single Hole Mount Receptacles

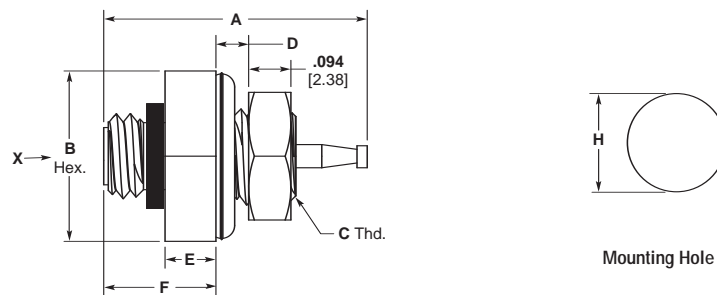

Part No.	A	B Hex.	C Thd.	D	E	F	H	X*
051-0249-0001	.563 14.29	.375 9.53	12-32 UNEF-2A	.078 1.98	.109 2.78	.234 5.95	.218 5.54	S-50
051-0154-0001	.656 16.67	.625 15.88	3/8-32 UNEF-2A	.156 3.97	.078 1.98	.203 5.16	.375 9.53	S-93

* "S" indicates Screw-On Series
Dimensions are subject to change without notice.