

IDMD-24-S-12.00-G

(2,54mm) .100"

IDSS, IDSD, IDMS, IDMD SERIES

SLIM BODY FLAT RIBBON IDC CABLES

SPECIFICATIONS

IDSS, IDSD

For complete specifications see www.samtec.com?IDSS or www.samtec.com?IDSD

Insulator Material:

Black Glass Filled Polyester



Plating:

Au over 50µ" (1,27µm) Ni or Sn over 100µ" (2,54µm) Cu or 50µ" (1,27µm) Ni

Wire:

28 AWG 7/36 stranded Tinned Copper

Temperature Range:

-20°C to +105°C (Rainbow Cable)
-40°C to +105°C (Gray Cable)

Contact:

BeCu

Current Rating:

1A

Contact Resistance:

15 mΩ max delta from initial

Lead Size Range:

(0,56mm) .022" SQ to (0,71mm) .028" SQ

Lead Insertion Depth:

(5,59mm) .220" to (6,22mm) .245"

Insertion Force:

(Single contact only)

4oz avg.

((0,64mm) .025" SQ probe)

Withdrawal Force:

(Single contact only)

3oz avg.

((0,64mm) .025" SQ probe)

RoHS Compliant: Yes

Mates with:

TSW, MTSW, TSM, EJH, PHT

IDSD Mates with:

TST, HTST, ZST

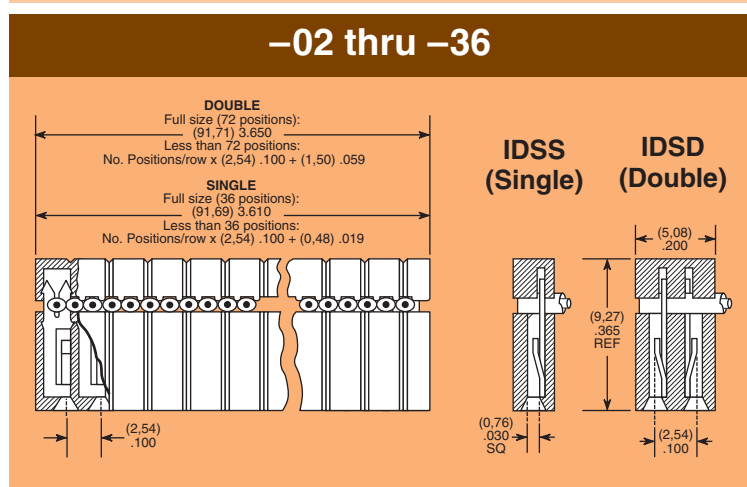
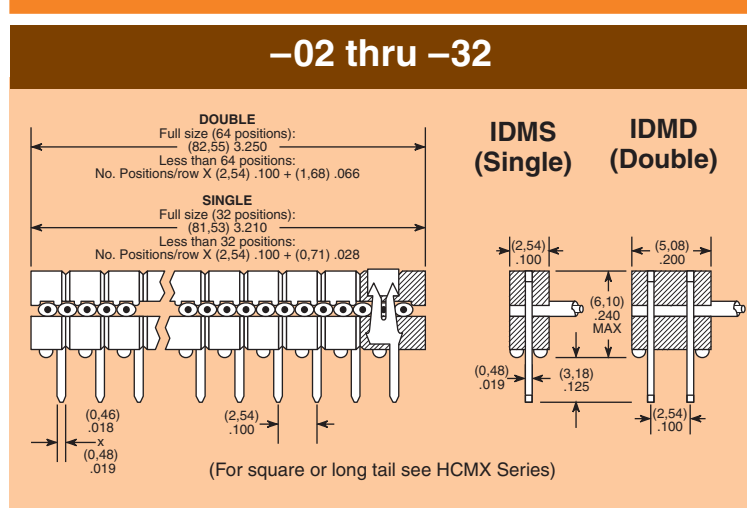
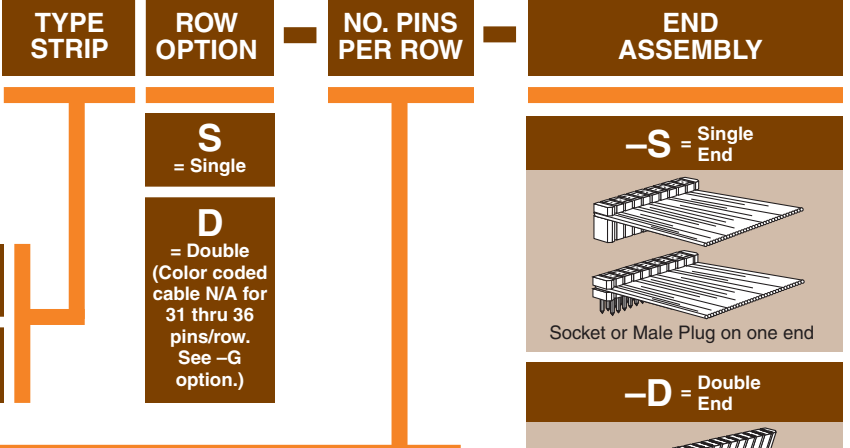

SPECIFICATIONS

IDMS, IDMD

For complete specifications see www.samtec.com?IDMS or www.samtec.com?IDMD

Insulator Material:

Black Glass Filled Polyester



Plating:

Au over 50µ" (1,27µm) Ni or Sn over 100µ" (2,54µm) Cu or 50µ" (1,27µm) Ni

Wire:

28 AWG 7/36 stranded Tinned Copper

Temperature Range:

-20°C to +105°C (Rainbow Cable)
-40°C to +105°C (Gray Cable)

Terminal:

Phosphor Bronze

Current Rating:

1A

RoHS Compliant: Yes

Note:

This Series is non-standard, non-returnable.

ALSO AVAILABLE

Molded-To-Position IDC Assemblies

- Low Profile
- Skinny side locks
- Dual beam contacts
- Single and double row
- (6,35mm) .025" square and (5,84mm) .230" length tail available

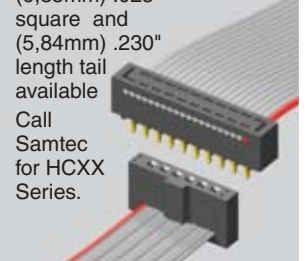

Call Samtec for HCXX Series.

Due to technical progress, all designs, specifications and components are subject to change without notice.

WWW.SAMTEC.COM



IDSD-24-S-05.00



IDSD-05-D-04.25-S02

ASSEMBLED LENGTH

— “XX.XX”
= Assembled Length



OPTION

POLARIZING KEY

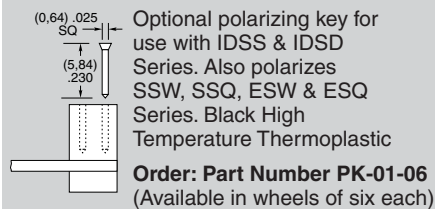

EJECTOR HEADERS & LOCKING CLIPS

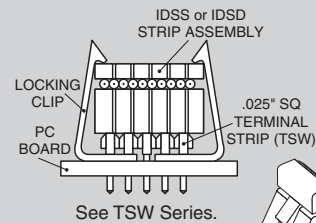

RUGGEDIZED
by SAMTEC
• Ejector headers
• Locking clips

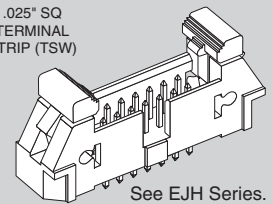

—T = Tin Plating (Both ends)

—C = Tin IDM = 10 μ (0,25 μ m) Gold IDS (-T End Assembly Required)

—A = 10 μ (0,25 μ m) Gold IDM = Tin IDS (-T End Assembly Required)

Standard plating is selective gold over BeCu contact for IDS; Selective gold over phosphor bronze for IDM.

—P “XX”
= Polarized

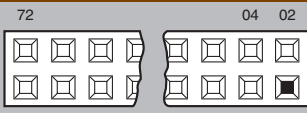

Specify “XX” as position. For Double the same position will be polarized on both ends. (Not available on IDM or EDM, unless transfer, then only the socket is polarized.)

—G
= Gray Cable

Specify -G for Gray cable. Gray cable has one red edge. IDSS and IDMS uses .100" centerline cable. IDSD and IDMD uses .050" centerline cable. Cable is 28 AWG 7/36 copper wire. Standard cable is same as above except color coded.

—ST “X”
= Stripped & Tinned

Specify Suffix from table. All dimensions are $\pm 1/16"$. Not available in 28 positions and higher.

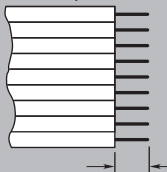

—B “XX”
= Breakout

Specify “XX” as number of conductors to be broken out.

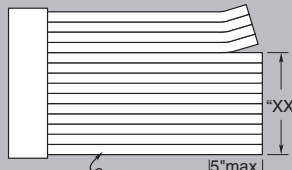

Breakout starts with Number 1 lead indicated by brown wire or red stripe. Shown on top side.

—RW
= Reversed Wiring

#1 wire opposite position #1.

—S “XX”
= Daisy Chain Single

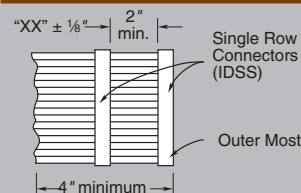

When mating double row connector with two single row connectors, the outer most single will be connected to Conductor #1 and the inside single to Conductor #2.

—D “XX”
= Daisy Chain, Double

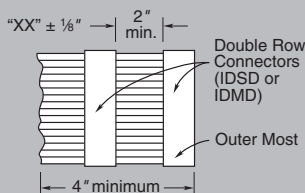

—W “XX”
= Wiring Reversed Daisy Chain, Single

Same as -S “XX” except outer strip connected to Conductor #2 and inside strip connected to Conductor #1.

—R
= Reversed

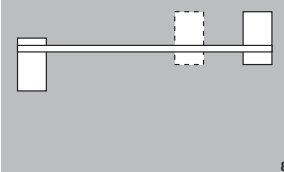

—M
= Middle Reversed

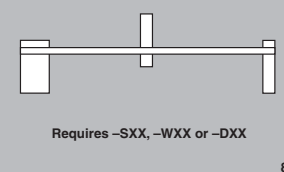

—O
= Outside Reversed

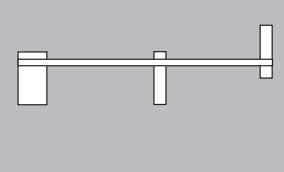

Due to technical progress, all designs, specifications and components are subject to change without notice.

WWW.SAMTEC.COM

SAMTEC USA • Tel: 1-800-SAMTEC-9 or 812-944-6733 SAMTEC SILICON VALLEY • Tel: 408-395-5900 SAMTEC SOUTHERN CALIFORNIA • Tel: 1-800-726-8329
SAMTEC AMERICA LATINA COMERCIO EXTERIOR LTDA • Tel: (+55 31) 3786 3227 SAMTEC UNITED KINGDOM • Tel: 44 01236 739292 SAMTEC GERMANY • Tel: +49 (0) 89 / 89460-0
SAMTEC FRANCE • Tel: 33 01 60 95 06 60 SAMTEC ITALY • Tel: 39 039 8890337 SAMTEC NORDIC/BALTIC • Tel: +46-84477280 SAMTEC BENELUX • Tel: 44 01236 739292 SAMTEC ISRAEL • Tel: 972-3-7526600
SAMTEC INDIA • Tel: +91-80-3272 1612 SAMTEC ASIA PACIFIC • Tel: 65 6745-5955 SAMTEC JAPAN • Tel: 045-475-1385 SAMTEC CHINA • Tel: 86-21-61103766 SAMTEC TAIWAN • Tel: 886-2-2735-6109
SAMTEC HONG KONG • Tel: 852-2600-9858 SAMTEC KOREA • Tel: 82-31-717-5685 SAMTEC ANZ • Tel: 613 9512 7747 SAMTEC SOUTH AFRICA • Tel: 27 11 452 8112