



(1,27mm) .050"

FFSD, FFMD SERIES

FFSD-20-S-10.00-01-N



FFMD-20-T-02.00-01-N-R

TIGER EYE™ FLAT IDC WIRE CABLES

SPECIFICATIONS

Mates with:

FTS, FTSH, EHF, SHF, ESHF

For complete specifications see www.samtec.com?FFSD

FFSD

Insulator Material: PBT



Contact:

BeCu

Plating:

10µ" (0,25µm) Au over 50µ" (1,27µm) Ni on contact area; Sn over 50µ" (1,27µm) Ni on balance

Wire:

30 AWG

Current Rating:

0.5A

Operating Temp Range:

-40°C to +105°C

Lead Size Accepted:

(0,41mm) .016" SQ

Contact Resistance:

15 mΩ maximum

delta from initial

Insertion Depth:

(2,64mm) .104" to

(3,17mm) .125"

Insertion Force:

(Single contact only)

5oz (1,39N) avg.

Withdrawal Force:

(Single contact only)

3oz (0,83N) avg.

RoHS Compliant:

Yes

Note: This Series is non-standard, non-returnable.

SPECIFICATIONS

Mates with:

FLE*, SFMC*

For complete specifications see www.samtec.com?FFMD

FFMD

Insulator Material: Black Glass Filled Polyester



Terminal:

BeCu

Plating:

Sn over 50µ" (1,27µm) Ni

Wire:

30 AWG

Current Rating:

0.5A

Operating Temp Range:

-40°C to +105°C

RoHS Compliant:

Yes

***Note:** Standard FFMD callout will not mate with FLE, SFMC. Must use gold plated callouts. (See drawing on web.)

When mated with a socket, Wire 1 mates with Pin 2; Wire 2 mates with Pin 1, etc.

Note: This Series is non-standard, non-returnable.

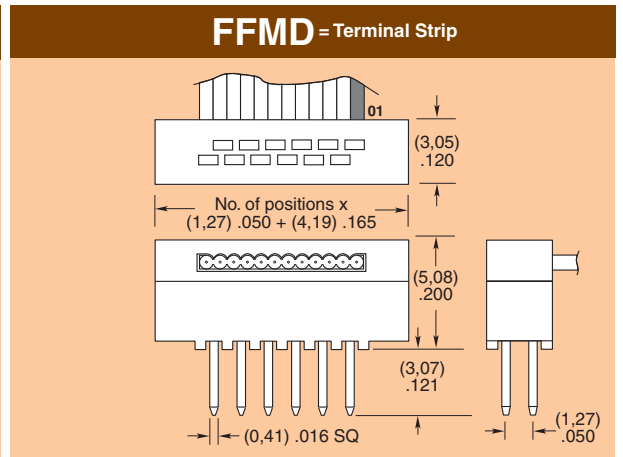
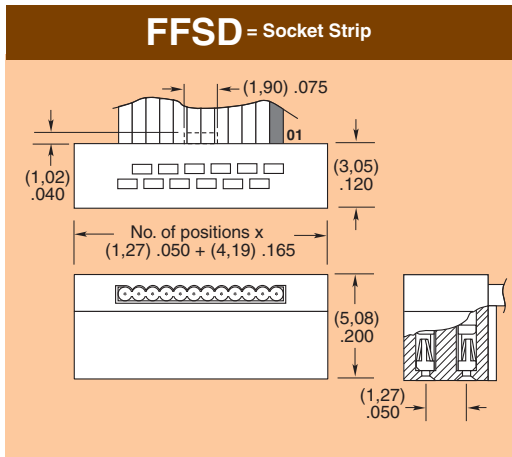
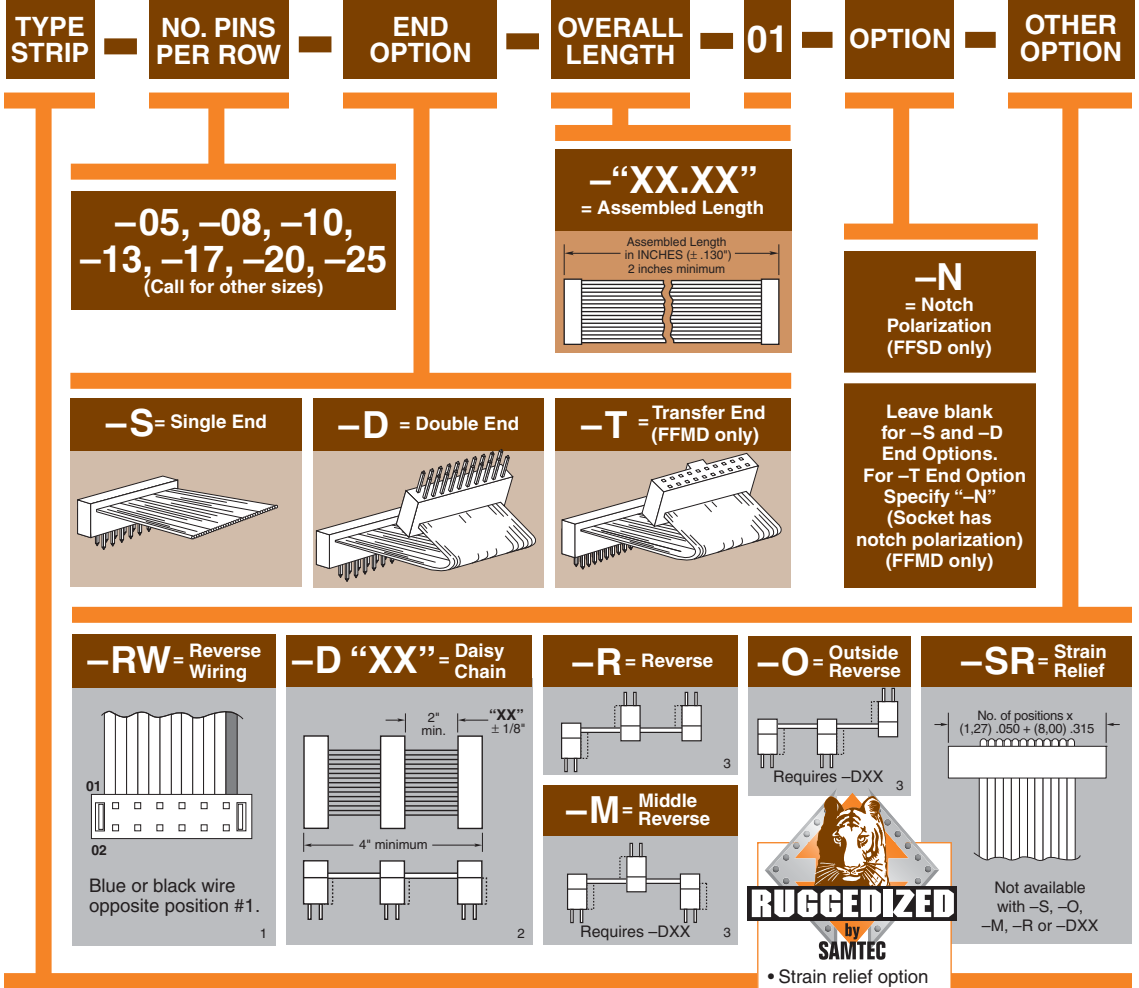

Due to technical progress, all designs, specifications and components are subject to change without notice.

WWW.SAMTEC.COM

SAMTEC USA • Tel: 1-800-SAMTEC-9 or 812-944-6733 SAMTEC SILICON VALLEY • Tel: 408-395-5900 SAMTEC SOUTHERN CALIFORNIA • Tel: 1-800-726-8329
 SAMTEC AMERICA LATINA COMERCIO EXTERIOR LTDA • Tel: (+55 31) 3786 3227 SAMTEC UNITED KINGDOM • Tel: 44 01236 739292 SAMTEC GERMANY • Tel: +49 (0) 89 / 89460-0
 SAMTEC FRANCE • Tel: 33 01 60 95 06 60 SAMTEC ITALY • Tel: 39 039 8690337 SAMTEC NORDIC/BALTIC • Tel: +46-84477280 SAMTEC BENELUX • Tel: 44 01236 739292 SAMTEC ISRAEL • Tel: 972-3-7526600
 SAMTEC INDIA • Tel: +91-90-3272 1612 SAMTEC ASIA PACIFIC • Tel: 65 6745-5955 SAMTEC JAPAN • Tel: 045-475-1385 SAMTEC CHINA • Tel: 86-21-61103766 SAMTEC TAIWAN • Tel: 886-2-2735-6109
 SAMTEC HONG KONG • Tel: 852-2600-9858 SAMTEC KOREA • Tel: 82-31-717-5685 SAMTEC ANZ • Tel: 613 9512 7747 SAMTEC SOUTH AFRICA • Tel: 27 11 452 8112