

For housing types and dim A and B see sheet 4

Partnumber:
10056101-IYZABCILF

- X = PLATING
 1 = TELCORDIA CO (see note 2 sheet 5)
 5 = TELCORDIA UE
- YZ = HOUSING TYPE
 01 = 2 wall narrow body
 04 = 4 wall narrow body
 05 = 2 wall wide body (STANDARD VERSION)
 08 = 4 wall wide body

- ABC = PINLAYOUT
 001 = standard layout (no detect pin)
 xxx = other versions see sheet 2

- LF = Lead Free
 LF = Lead free product (see note 8 sheet 5)
 no suffix = Non lead free: available upon special request

2 WALL WIDE BODY VERSION AS SHOWN

rev	ecn no	dr	date
A	H06-0057	EDB	2006-04-10
B	H06-0109	EDB	2006-06-23
C	S06-0370	MCH	2006-11-07
D	S07-0213	MCH	2006-06-20
E	S10-0149	MCH	2010-07-21
-	-	-	-
-	-	-	-

www.fciconnect.com		surface ISO 1302	tolerance std ISO 406 ISO 1101	projection mm
		TOLERANCES UNLESS OTHERWISE SPECIFIED		mm
Dr	P.K.Ramesh	2005-09-23	ANGULAR	size A3
Eng	R.de Bleeck	2005-09-23	LINEAR	Scale 1:1
Chr	M. Cheong	2010-07-21	0° ±°	ECN S10-0149
Appr	Joey Ng	2010-07-21	Product family	Spec ref RELEASE
FCI		AirMax VS VERTICAL HEADER		Rev. E
catalog no		3 Pair, 54 pos., 2mm, 6 IMLA		10056101
		CUSTOMER		sheet 1 of 5

Copyright FCI

REV - 2006-04-17

* Detection pin of 3.9mm possible on standard positions H3.
 For other detection pin and options please consult FCI.

Partnumber \ Pin layout	5.6mm Longpins (typ gnd)	3.9mm * Short pin (typ detect)	4.6mm Otherpins (typ sign)
10056101-XYZ0011(LF)	F1,F3,F5 G2,G4,G6	-	all other positions
10056101-XYZ0031(LF)	F1,F3,F5 G2,G4,G6	H3	all other positions

	title	AirMax VS VERTICAL HEADER	dwg no	10056101	Rev.
		3 Pair, 54 pos, 2mm, 6 IMLA			E
	catalog no	-	CUSTOMER	sheet 2 of 5	

REV F - 2006-04-11

FDM: Rev:E STATUS:Released Printed: Dec 01, 2010

NARROW BODY

WIDE BODY

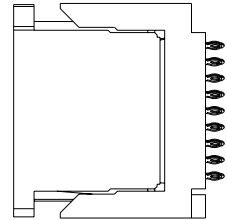
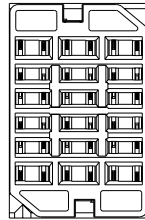
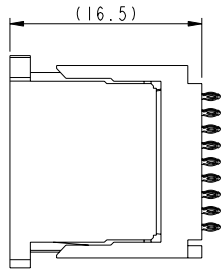
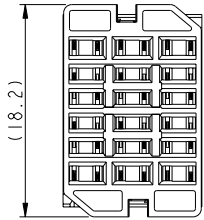

SCALE 3:1

Triangle indicates position A1.
SEE NOTE 12.

SEE NOTE 13.

Triangle indicates position A1.
SEE NOTE 12.

SEE NOTE 14.

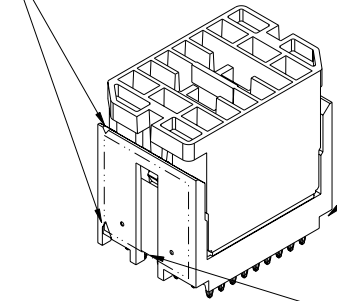

Cut-out at opposite side
of A1 indicator.
SEE NOTE 12.

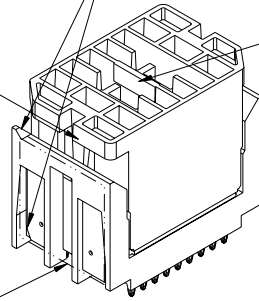

SCALE 3:1

NOTE 5 & 12

	title	AirMax VS VERTICAL HEADER	dwg no	10056101	Rev.
	3 Pair, 54 pos, 2mm, 6 IMLA				E
	catalog no		CUSTOMER	sheet 3 of 5	

REV F - 2006-04-11

FDM: Rev:E STATUS:Released Printed: Dec 01, 2010

Copyright FCI.
FCI

1 2 3 4

NARROW BODY

WIDE BODY

10056101 - X01ABC I

10056101 - X04ABC I

10056101 - X05ABC I

10056101 - X08ABC I

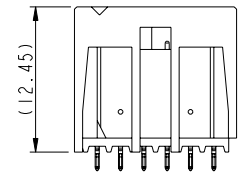
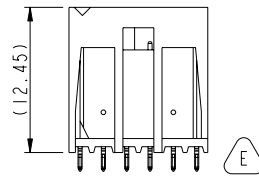
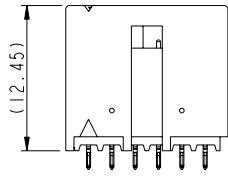
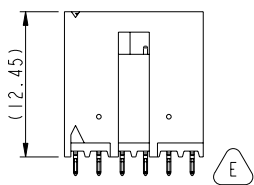
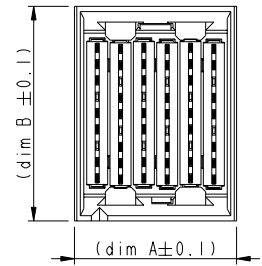
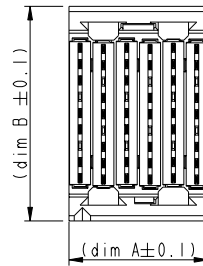
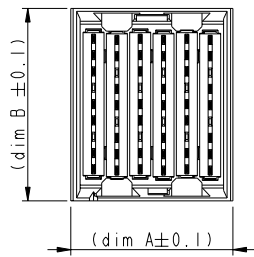
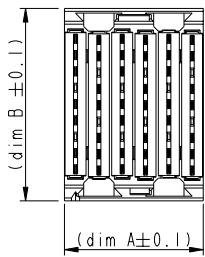

PN / dim	A	B
10056101-X01ABC I(LF)	11.9	16.5
10056101-X04ABC I(LF)	13.9	16.5
10056101-X05ABC I(LF)	11.9	18.4
10056101-X08ABC I(LF)	13.9	18.4

	title AirMax VS VERTICAL HEADER 3 Pair, 54 pos, 2mm, 6 IMLA	dwg no 10056101	Rev. E
	catalog no	CUSTOMER	sheet 4 of 5
	FDM: Rev:E STATUS:Released Printed: Dec 01, 2010		

1 2 3 4

Copyright FCI.

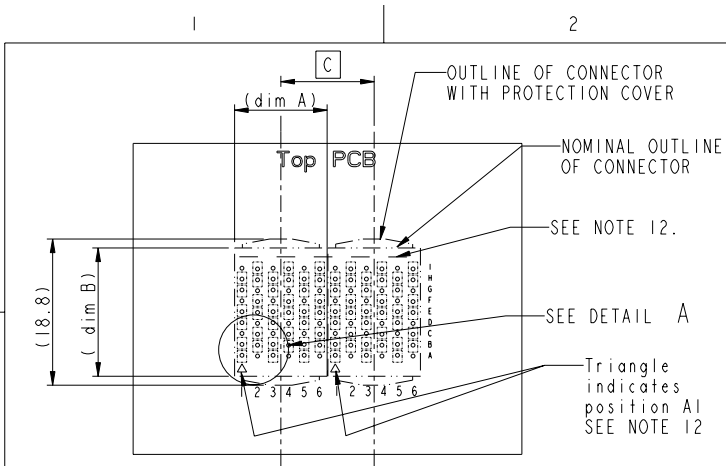

RECOMMENDED PCB LAYOUT FOR DIFFERENTIAL APPLICATIONS COMPONENT SIDE (TWO ADJACENT FOOTPRINTS SHOWN)

PN / dim	A	B	C
10056101-X01ABCI(LF)	11.9	16.5	12
10056101-X04ABCI(LF)	13.9	16.5	14
10056101-X05ABCI(LF)	11.9	18.4	12
10056101-X08ABCI(LF)	13.9	18.4	14

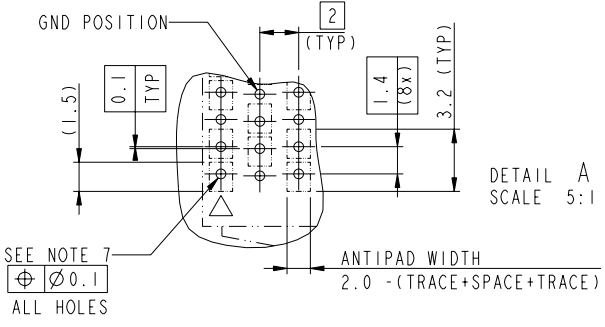

NOTES:

- CONNECTOR MATERIALS:
HOUSING : HIGH TEMP THERMOPLASTIC, NATURAL, UL94V-0
PROTECTION COVER : HIGH TEMP THERMOPLASTIC, BLACK, UL94V-0
IMLA PLASTIC: HIGH TEMP THERMOPLASTIC, BLACK UL94V-0
CONTACT: COPPER ALLOY
- CONTACT PLATING:
SEPARABLE INTERFACE: PERFORMANCE-BASED PLATING, QUALIFIED TO MEET THE REQUIREMENTS OF FCI PRODUCT SPECIFICATION GS-12-239, INCLUDING TELCORDIA GR-1217-CORE (NOV 1995) TEST SEQUENCE.
PRESS-FIT TAILS: TIN-LEAD (NON LEAD FREE) OR TIN OVER NICKEL (LEAD FREE)
- PRODUCT SPECIFICATION: GS-12-239.
- APPLICATION SPECIFICATION: GS-20-035. FLATROCK INSERTION INTO PCB BY PUSHING ON TOP OF SURFACE PROTECTION COVER
- PRODUCT MARKING, (PARTNUMBER & LOTCODE).
- PROTECTION COVER MUST BE REMOVED BEFORE MATING WITH RECEPTACLE CONNECTOR
- SEE CUSTOMER DRAWING 10045979 FOR INFORMATION ON PCB HOLE DIAMETER AND PLATING OPTIONS.
- LEAD FREE PRODUCT MEETS THE EUROPEAN UNION DIRECTIVE & OTHER COUNTRY REGULATIONS AS DESCRIBED IN GS-22-008.
- THE HOUSING SHOULD WITHSTAND EXPOSURE TO 260°C PEAK TEMPERATURE FOR 40 SECONDS IN A CONVECTION, INFRA-RED OR VAPOR PHASE REFLOW OVEN.
- PACKAGE PER GS-14-1086 AND GS-14-920 LEAD FREE LABELING SPEC.
- THERE IS NO GROUND BUSSING WITHIN THE CONNECTOR SYSTEM.
- IT IS RECOMMENDED TO PUT THIS VISIBLE LINE AND THE A1 INDICATION (TRIANGLE) ON THE PCB TO INDICATE PROPER ORIENTATION. OTHER VISIBLE POLARIZATION MARKS ARE A1 INDICATOR AND PRINTING SIDE. (SEE SHEET 3)
- GRIPPING FEATURE TO REMOVE PROTECTION COVER BY FINGERS.
- GRIPPING FEATURE TO REMOVE PROTECTION COVER BY STANDARD PLIERS.
- A \triangle SYMBOL WILL BE NEXT TO ANY DIMENSION, VIEW OR NOTE WHICH HAS BEEN MODIFIED WITH THE CURRENT DRAWING REVISION.

FCI	title	AirMax VS VERTICAL HEADER	dwg no	10056101	Rev.	E
	catalog no	3 Pair, 54 pos, 2mm, 6 IMLA	CUSTOMER	sheet 5 of 5		