

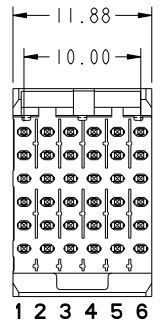

This document is the property of and embodies
 CONFIDENTIAL and PROPRIETARY information of FCJ.
 No part of the information shown on this
 document may be used in any way or disclosed
 to others without the written consent of FCJ.
 Copyright FCJ.

PRODUCT NUMBER	PLATING PERFORMANCE LEVEL	APPLICATION	FOR REAR PLUG-UP APPLICATIONS USE SHROUD
74817-1ZZZ	TELCORDIA CO	STANDARD	84818-104
74817-1ZZZLF		LEAD FREE	84818-104LF
74817-5ZZZ	TELCORDIA UE	STANDARD	84818-504
74817-5ZZZLF		LEAD FREE	84818-504LF
74817-9ZZZ	TELCORDIA CO	STANDARD	84818-104
74817-9ZZZLF		LEAD FREE	84818-104LF

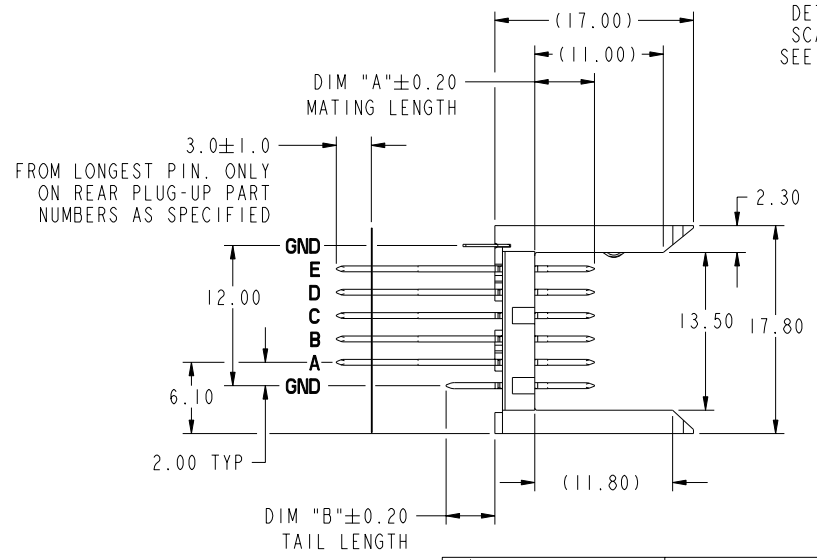
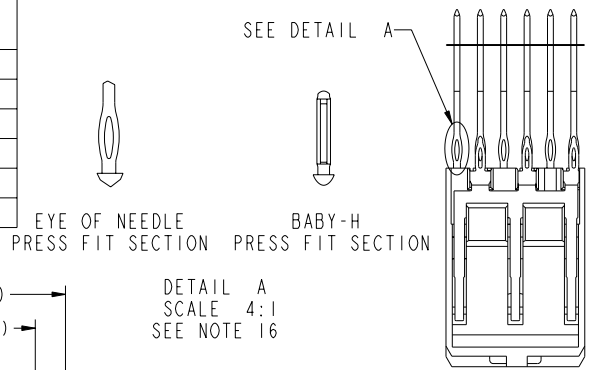

mat'l code: SEE NOTE 5				tolerances unless otherwise specified				CUSTOMER		FCJ	
ltr	ecm no.	dr	date	0.X ± 0.3				COPY		www.fcjconnect.com	
AW	V08-0141	LP	2008-03-28	0.XX ± 0.13				projection		title	
-	-	-	-	.XXX ± 0.051				MM		VERTICAL SIGNAL HDR 5 ROW	
AR	V07-0187	DCH	2007-04-24	0° $\pm 2^\circ$				scale		P.F. 30 POS. SELECT LOAD STD.	
AS	V07-0676	HTB	2007-11-07	dr	K. BELL	2000-03-29	2:1		product family		
AT	V07-0697	LP	2007-11-29	enr	M. HAHN	2000-03-29	A		METRAL 1000		
AU	V08-0002	HTB	2008-01-09	chr	M. HAHN	2000-03-29	A		code		
AV	V08-0048	LP	2008-2-1	oppd	M. HAHN	2000-03-29	A		213		
sheet index	revision	AW	AW	AW	AW	AW	AW	AW	AW	AW	sheet 1 of 9
	sheet	1	2	3	4	5	6	7	8	9	

Pro/E 3 cage code 22526 4

PDM: Rev:AW STATUS:Released Printed: Feb 20, 2010

PRODUCT NUMBER
SEE SHEET 1

PRESS-FIT HOLES	OPTION 1
HOLE DIAMETER AFTER PLATING	0.65-0.80
DRILLED HOLE	0.81-0.86 (0.85 DRILL)
COPPER PLATING	0.025 MIN
SnPb PLATING	0.005-0.015

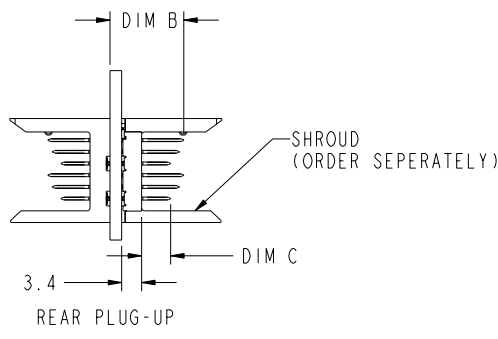

SEE PRINT 58351 FOR ADDITIONAL PCB INFORMATION

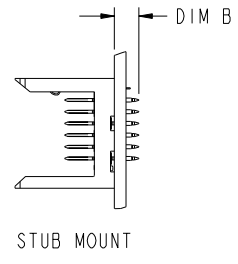
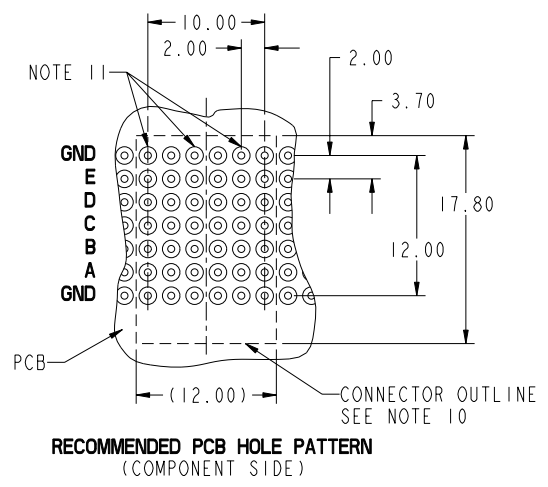

mat'l code: SEE NOTE 5				tolerances unless otherwise specified		CUSTOMER		FCJ	
litr	ecn no.	dr	date	linear	0.X ±0.3	COPY		www.fcjconnect.com	
AW					0.XX ±0.13	projection		title VERTICAL SIGNAL HDR 5 ROW	
				angles	.XXX ±.051	MM		P.F. 30 POS. SELECT LOAD STD.	
				dr	0° ±2°	scale		product family METRAL 1000	
				enr		2:1		size dwg no	
				chr	K. BELL 2000-03-29	A		74817	
				oppd	M. HAHN 2000-03-29			code 213	
					M. HAHN 2000-03-29			sheet 2	
sheet index	revision sheet								



This document is the property of and embodies CONFIDENTIAL and PROPRIETARY information of FCJ. No part of the information shown on this document may be used in any way or disclosed to others without the written consent of FCJ. Copyright FCJ.

REV E - 2006-04-18

Pro/E 3 cage code 22526 4

PDM: Rev:AW STATUS:Released Printed: Feb 20, 2010



This document is the property of and embodies
 CONFIDENTIAL and PROPRIETARY information of FCJ.
 No part of the information shown on this
 document may be used in any way or disclosed
 to others without the written consent of FCJ.
 Copyright FCJ.

PIN CODE NO.	DIM A MATING LENGTH	DIM B TAIL LENGTH	PCB THICKNESS RANGE ACCOMMODATED BY PIN'S TAIL LENGTH				
			WHEN MATING TO A 73981 OR 84688 SERIES METRAL 1000 RECEPTACLE		WHEN MATING TO A 52057 SERIES METRAL 4000 RECEPTACLE		
			ROWS A,B,C,D,E	GROUND ROW	ROWS:A,B,D,E	ROW C	GROUND ROW
01*	5.00	4.30	1.60 MIN	1.60 MIN	1.60 MIN	1.60 MIN	1.60 MIN
22		12.20	2.95 - 3.80	2.95 - 4.20	2.95 - 3.80	2.95 - 3.80	2.95 - 4.20
30		12.95	2.95 - 4.55	3.25 - 4.95	2.95 - 4.55	2.95 - 4.55	3.25 - 4.95
05		13.70	2.95 - 5.30	4.00 - 5.70	3.30 - 5.30	2.95 - 5.30	4.00 - 5.70
35		14.45	3.05 - 6.05	4.75 - 6.45	4.05 - 6.05	3.05 - 6.05	4.75 - 6.45
48		15.20	3.80 - 6.80	5.50 - 7.20	4.80 - 6.80	3.80 - 6.80	5.50 - 7.20
40		15.70	4.30 - 7.30	6.00 - 7.70	5.30 - 7.30	4.30 - 7.30	6.00 - 7.70
65		16.40	5.00 - 8.00	6.70 - 8.40	6.00 - 8.00	5.00 - 8.00	6.70 - 8.40
09		17.10	5.70 - 8.70	7.40 - 9.10	6.70 - 8.70	5.70 - 8.70	7.40 - 9.10
02*		5.75	4.30	1.60 MIN	1.60 MIN	1.60 MIN	1.60 MIN
44	12.20		2.95 - 3.80	2.95 - 4.20	2.95 - 3.80	2.95 - 3.80	2.95 - 4.20
31	12.95		2.95 - 4.55	3.25 - 4.95	2.95 - 4.55	2.95 - 4.55	3.25 - 4.95
06	13.70		2.95 - 5.30	4.00 - 5.70	3.30 - 5.30	2.95 - 5.30	4.00 - 5.70
36	14.45		3.05 - 6.05	4.75 - 6.45	4.05 - 6.05	3.05 - 6.05	4.75 - 6.45
49	15.20		3.80 - 6.80	5.50 - 7.20	4.80 - 6.80	3.80 - 6.80	5.50 - 7.20
25	15.70		4.30 - 7.30	6.00 - 7.70	5.30 - 7.30	4.30 - 7.30	6.00 - 7.70
66	16.40		5.00 - 8.00	6.70 - 8.40	6.00 - 8.00	5.00 - 8.00	6.70 - 8.40
10	17.10		5.70 - 8.70	7.40 - 9.10	6.70 - 8.70	5.70 - 8.70	7.40 - 9.10
03*	6.50		4.30	1.60 MIN	1.60 MIN	1.60 MIN	1.60 MIN
45		12.20	2.95 - 3.80	2.95 - 4.20	2.95 - 3.80	2.95 - 3.80	2.95 - 4.20
32		12.95	2.95 - 4.55	3.25 - 4.95	2.95 - 4.55	2.95 - 4.55	3.25 - 4.95
07		13.70	2.95 - 5.30	4.00 - 5.70	3.30 - 5.30	2.95 - 5.30	4.00 - 5.70
37		14.45	3.05 - 6.05	4.75 - 6.45	4.05 - 6.05	3.05 - 6.05	4.75 - 6.45
50		15.20	3.80 - 6.80	5.50 - 7.20	4.80 - 6.80	3.80 - 6.80	5.50 - 7.20
41		15.70	4.30 - 7.30	6.00 - 7.70	5.30 - 7.30	4.30 - 7.30	6.00 - 7.70
24		16.40	5.00 - 8.00	6.70 - 8.40	6.00 - 8.00	5.00 - 8.00	6.70 - 8.40
11		17.10	5.70 - 8.70	7.40 - 9.10	6.70 - 8.70	5.70 - 8.70	7.40 - 9.10

* STUB PINS - NO REAR PLUG-UP
 ** THE GREATEST RANGE OCCURS WHEN THE B DIMENSION OF PIN 'GND' IS ONE SIZE SHORTER THEN THE OTHER PINS.

mat'l code: SEE NOTE 5		tolerances unless otherwise specified		CUSTOMER	www.fcjconnect.com
lfr	ecr no.	dr	date	COPY	
AW				projection	
				linear	
				angles	.XXX ±.051
				dr	0° ±2°
				engr	K. BELL 2000-03-29
				chr	M. HAHN 2000-03-29
				oppd	M. HAHN 2000-03-29
sheet index	revision sheet			scale	MM
				2:1	product family METRAL 1000
				A	size dwg no 74817
					code 213
					sheet 3

REV E - 2006-04-18

PDM: Rev:AW

STATUS:Released

Printed: Feb 20, 2010

cage code 22526



This document is the property of and embodies CONFIDENTIAL and PROPRIETARY information of FCJ. No part of the information shown on this document may be used in any way or disclosed to others without the written consent of FCJ. Copyright FCJ.

PIN CODE NO.	DIM A MATING LENGTH	DIM B TAIL LENGTH	PCB THICKNESS RANGE ACCOMMODATED BY PIN LENGTH				
			WHEN MATING TO A 73981 OR 84688 SERIES RECEPTACLE		WHEN MATING TO A 52057 SERIES METRAL 4000 RECEPTACLE		
			ROWS A,B,C,D,E	GROUND ROW	ROWS:A,B,D,E	ROW C	GROUND ROW
04*	7.25	4.30	1.60 MIN	1.60 MIN	1.60 MIN	1.60 MIN	1.60 MIN
46		12.20	2.95 - 3.80	2.95 - 4.20	2.95 - 3.80	2.95 - 3.80	2.95 - 4.20
33		12.95	2.95 - 4.55	3.25 - 4.95	2.95 - 4.55	2.95 - 4.55	3.25 - 4.95
08		13.70	2.95 - 5.30	4.00 - 5.70	3.30 - 5.30	2.95 - 5.30	4.00 - 5.70
38		14.45	3.05 - 6.05	4.75 - 6.45	4.05 - 6.05	3.05 - 6.05	4.75 - 6.45
51		15.20	3.80 - 6.80	5.50 - 7.20	4.80 - 6.80	3.80 - 6.80	5.50 - 7.20
42		15.70	4.30 - 7.30	6.00 - 7.70	5.30 - 7.30	4.30 - 7.30	6.00 - 7.70
67		16.40	5.00 - 8.00	6.70 - 8.40	6.00 - 8.00	5.00 - 8.00	6.70 - 8.40
12		17.10	5.70 - 8.70	7.40 - 9.10	6.70 - 8.70	5.70 - 8.70	7.40 - 9.10
19*		8.00	4.30	1.60 MIN	1.60 MIN	1.60 MIN	1.60 MIN
47	12.20		2.95 - 3.80	2.95 - 4.20	2.95 - 3.80	2.95 - 3.80	2.95 - 4.20
34	12.95		2.95 - 4.55	3.25 - 4.95	2.95 - 4.55	2.95 - 4.55	3.25 - 4.95
20	13.70		2.95 - 5.30	4.00 - 5.70	3.30 - 5.30	2.95 - 5.30	4.00 - 5.70
39	14.45		3.05 - 6.05	4.75 - 6.45	4.05 - 6.05	3.05 - 6.05	4.75 - 6.45
52	15.20		3.80 - 6.80	5.50 - 7.20	4.80 - 6.80	3.80 - 6.80	5.50 - 7.20
43	15.70		4.30 - 7.30	6.00 - 7.70	5.30 - 7.30	4.30 - 7.30	6.00 - 7.70
68	16.40		5.00 - 8.00	6.70 - 8.40	6.00 - 8.00	5.00 - 8.00	6.70 - 8.40
21	17.10		5.70 - 8.70	7.40 - 9.10	6.70 - 8.70	5.70 - 8.70	7.40 - 9.10

* STUB PINS - NO REAR PLUG-UP
 ** THE GREATEST RANGE OCCURS WHEN THE B DIMENSION OF PIN 'GND' IS ONE SIZE SHORTER THEN THE OTHER PINS.

mat'l code		SEE NOTE 5		tolerances unless otherwise specified		CUSTOMER		FCJ		www.fcjconnect.com	
lfr	ecr no.	dr	date	linear	0.X ± 0.3	projection	COPY		title		
AW					.XXX ± 0.13				VERTICAL SIGNAL HDR 5 ROW		
				angles	0° ± 2°				P.F. 30 POS. SELECT LOAD STD.		
				dr	K. BELL 2000-03-29	scale	A		product family		code
				enr	M. HAHN 2000-03-29	1:1			METRAL 1000		213
				chr	M. HAHN 2000-03-29				size		sheet
				oppd	M. HAHN 2000-03-29				74817		4
sheet index	revision sheet								cage code		
									22526		4

PDM: Rev:AW

STATUS:Released

Printed: Feb 20, 2010



This document is the property of and embodies CONFIDENTIAL and PROPRIETARY information of FCI. No part of the information shown on this document may be used in any way or disclosed to others without the written consent of FCI. Copyright FCI.

METRAL P/N	ROW	CONTACT CODE					
		1	2	3	4	5	6
74817-X001 ** SEE NOTE 15 LEAD FREE OPTION	E	04	03	03	01	01	01
	D	04	03	03	01	01	01
	C	04	03	03	01	01	01
	B	04	03	03	01	01	01
	A	04	03	03	01	01	01
GND	01	01	01	01	01	01	

METRAL P/N	ROW	CONTACT CODE					
		1	2	3	4	5	6
74817-X002 ** SEE NOTE 15 LEAD FREE OPTION	E	01	01	01	01	03	04
	D	01	01	01	01	03	04
	C	01	01	01	01	03	04
	B	01	01	01	01	03	04
	A	01	01	01	01	03	04
GND	01	01	01	01	01	01	

METRAL P/N	ROW	CONTACT CODE					
		1	2	3	4	5	6
74817-X003 ** SEE NOTE 15 LEAD FREE OPTION	E	02	03	02	02	04	19
	D	02	03	02	02	04	19
	C	02	03	02	02	04	19
	B	02	03	02	02	04	19
	A	02	03	02	02	04	19
GND	01	01	01	01	01	01	

METRAL P/N	ROW	CONTACT CODE					
		1	2	3	4	5	6
74817-X004 ** SEE NOTE 15 LEAD FREE OPTION	E	03	02	02	04	19	02
	D	03	02	02	04	19	02
	C	03	02	02	04	19	02
	B	03	02	02	04	19	02
	A	03	02	02	04	19	02
GND	01	01	01	01	01	01	

METRAL P/N	ROW	CONTACT CODE					
		1	2	3	4	5	6
74817-X005 *RPU SEE NOTE 15 LEAD FREE OPTION	E	06	06	06	06	06	06
	D	06	06	06	06	06	06
	C	06	06	06	06	06	06
	B	06	06	06	06	06	06
	A	06	06	06	06	06	06
GND	30	30	30	30	30	30	

PCB THICKNESS RANGE FOR REAR PLUG UP APPLICATIONS: 3.25 - 4.55

METRAL P/N	ROW	CONTACT CODE					
		1	2	3	4	5	6
74817-X006 ** SEE NOTE 15 LEAD FREE OPTION	E	19	03	03	03	02	01
	D	19	03	03	03	02	01
	C	19	03	03	03	02	01
	B	19	03	03	03	02	01
	A	19	03	03	03	02	01
GND	01	01	01	01	01	01	

METRAL P/N	ROW	CONTACT CODE					
		1	2	3	4	5	6
74817-X007 *RPU ** SEE NOTE 15 LEAD FREE OPTION	E	20	07	07	07	06	05
	D	20	07	07	07	06	05
	C	20	07	07	07	06	05
	B	20	07	07	07	06	05
	A	20	07	07	07	06	05
GND	01	01	01	01	01	01	

PCB THICKNESS RANGE FOR REAR PLUG UP APPLICATIONS: 2.30 (2.95) - 5.30 (NOT A STANDARD METRAL 1000 APPL.). CANNOT BE MATED TO A METRAL 4000 RECEPTACLE

METRAL P/N	ROW	CONTACT CODE					
		1	2	3	4	5	6
74817-X008 ** SEE NOTE 15 LEAD FREE OPTION	E	19	03	03	03	03	03
	D	19	03	03	03	03	03
	C	19	03	03	03	03	03
	B	19	03	03	03	03	03
	A	19	03	03	03	03	03
GND	01	01	01	01	01	01	

METRAL P/N	ROW	CONTACT CODE					
		1	2	3	4	5	6
74817-X009 *RPU ** SEE NOTE 15 LEAD FREE OPTION	E	20	07	07	07	07	07
	D	20	07	07	07	07	07
	C	20	07	07	07	07	07
	B	20	07	07	07	07	07
	A	20	07	07	07	07	07
GND	01	01	01	01	01	01	

PCB THICKNESS RANGE FOR REAR PLUG UP APPLICATIONS: 2.30 (2.95) - 5.30 (NOT A STANDARD METRAL 1000 REAR PLUG UP APPL.). CANNOT BE MATED TO A METRAL 4000.

METRAL P/N	ROW	CONTACT CODE					
		1	2	3	4	5	6
74817-X010 SEE NOTE 15 LEAD FREE OPTION	E	03	03	03	03	03	03
	D	02	03	03	03	03	03
	C	03	03	03	03	03	03
	B	03	03	03	03	03	03
	A	03	03	03	03	03	03
GND	01	01	01	01	01	01	

METRAL P/N	ROW	CONTACT CODE					
		1	2	3	4	5	6
74817-X011 *RPU ** SEE NOTE 15 LEAD FREE OPTION	E	05	05	05	05	05	05
	D	05	05	05	05	05	05
	C	05	05	05	05	05	05
	B	05	05	05	05	05	05
	A	05	05	05	05	05	05
GND	01	01	01	01	01	01	

PCB THICKNESS RANGE FOR REAR PLUG UP APPL.: 2.30 (2.95) - 5.30 FOR METRAL 1000 RECEPTACLE (NOT A STANDARD METRAL 1000 APPL.) AND 2.30 (3.30) - 5.30 FOR METRAL 4000 APPL.

METRAL P/N	ROW	CONTACT CODE					
		1	2	3	4	5	6
74817-X012 *RPU ** SEE NOTE 15 LEAD FREE OPTION	E	02	02	06	06	06	06
	D	02	02	06	06	06	06
	C	02	02	06	06	06	06
	B	02	02	06	06	06	06
	A	02	02	06	06	06	06
GND	01	01	01	01	01	01	

PCB THICKNESS RANGE FOR REAR PLUG UP APPL.: 2.30 (2.95) - 5.30 FOR METRAL 1000 RECEPTACLE (NOT A STANDARD METRAL 1000 APPL.) AND 2.30 (3.30) - 5.30 FOR METRAL 4000 APPL.

METRAL P/N	ROW	CONTACT CODE					
		1	2	3	4	5	6
74817-X013 *RPU ** SEE NOTE 15 LEAD FREE OPTION	E	06	06	06	06	02	02
	D	06	06	06	06	02	02
	C	06	06	06	06	02	02
	B	06	06	06	06	02	02
	A	06	06	06	06	02	02
GND	01	01	01	01	01	01	

PCB THICKNESS RANGE FOR REAR PLUG UP APPL.: 2.30 (2.95) - 5.30 FOR METRAL 1000 RECEPTACLE (NOT A STANDARD METRAL 1000 APPL.) AND 2.30 (3.30) - 5.30 FOR METRAL 4000 APPL.

METRAL P/N	ROW	CONTACT CODE					
		1	2	3	4	5	6
74817-X014 *RPU ** SEE NOTE 15 LEAD FREE OPTION	E	10	10	10	10	10	10
	D	10	10	10	10	10	10
	C	10	10	10	10	10	10
	B	10	10	10	10	10	10
	A	10	10	10	10	10	10
GND	01	01	01	01	01	01	

PCB THICKNESS RANGE FOR REAR PLUG UP APPL.: 5.70 - 8.70 FOR METRAL 1000 APPL. (NOT A STANDARD METRAL 1000 APPL.) AND 6.70 - 8.70 FOR A METRAL 4000 APPLICATION.

METRAL P/N	ROW	CONTACT CODE					
		1	2	3	4	5	6
74817-X015 SEE NOTE 15 LEAD FREE OPTION	E	02	02	02	02	02	02
	D	02	02	02	02	02	02
	C	04	04	04	04	04	04
	B	02	02	02	02	02	02
	A	02	02	02	02	02	02
GND	02	02	02	02	02	02	

- * REAR PLUG-UP PART NUMBER WITH PIN ALIGNER
- ** CANNOT BE MATED TO A METRAL 4000 RECEPTACLE
- *** REAR PLUG-UP PART NUMBER WITHOUT PIN ALIGNER

mat'l code SEE NOTE 5				tolerances unless otherwise specified		CUSTOMER		FCI	
ltr	ecr no.	dr	date	linear	0.X ± 0.3	projection	www.fciconnect.com		title VERTICAL SIGNAL HDR 5 ROW P.F. 30 POS. SELECT LOAD STD.
AW				angles	.xxx ± .051		product family METRAL 1000		
				dr	0° ± 2°	MM	size	code	213
				enr	K. BELL 2000-03-29	scale	dwg no	sheet	5
				ctr	M. HAHN 2000-03-29	2:1	74817		
				oppd	M. HAHN 2000-03-29				
sheet index	revision	sheet							



This document is the property of and embodies CONFIDENTIAL and PROPRIETARY information of FCI. No part of the information shown on this document may be used in any way or disclosed to others without the written consent of FCI. Copyright FCI.

METRAL P/N	ROW	CONTACT CODE					
		1	2	3	4	5	6
74817-X016 SEE NOTE 15 LEAD FREE OPTION	E	02	02	02	02	02	02
	D	02	02	02	02	02	02
	C	04	04	04	04	04	04
	B	01	02	02	02	02	01
	A	02	02	02	02	02	02
GND	02	02	02	02	02	02	

METRAL P/N	ROW	CONTACT CODE					
		1	2	3	4	5	6
74817-X017 SEE NOTE 15 LEAD FREE OPTION	E	01	01	01	01	01	01
	D	01	01	01	01	01	01
	C	03	03	03	03	03	03
	B	01	01	01	01	01	01
	A	01	01	01	01	01	01
GND	01	01	01	01	01	01	

METRAL P/N	ROW	CONTACT CODE					
		1	2	3	4	5	6
74817-X018 SEE NOTE 15 LEAD FREE OPTION	E	03	02	02	01	01	01
	D	03	02	02	01	01	01
	C	03	02	02	03	03	03
	B	03	02	02	01	01	01
	A	03	02	02	01	01	01
GND	01	01	01	01	01	01	

METRAL P/N	ROW	CONTACT CODE					
		1	2	3	4	5	6
74817-X019 SEE NOTE 15 LEAD FREE OPTION	E	01	01	01	02	02	03
	D	01	01	01	02	02	03
	C	03	03	03	02	02	03
	B	01	01	01	02	02	03
	A	01	01	01	02	02	03
GND	01	01	01	01	01	01	

METRAL P/N	ROW	CONTACT CODE					
		1	2	3	4	5	6
74817-X023 ** SEE NOTE 15 LEAD FREE OPTION	E	01	03	03	03	01	01
	D	01	03	03	03	01	19
	C	01	01	01	01	01	19
	B	01	01	01	01	01	19
	A	01	01	01	19	19	19
GND	01	01	01	01	01	01	

* REAR PLUG-UP PART NUMBER WITH PIN ALIGNER
 ** CANNOT BE MATED TO A METRAL 4000 RECEPTACLE
 *** REAR PLUG-UP PART NUMBER WITHOUT PIN ALIGNER

METRAL P/N	ROW	CONTACT CODE						PCB THICKNESS RANGE FOR REAR PLUG UP APPL. : 2.30 (2.95) - 5.30 FOR METRAL 1000 APPL. (NOT A STANDARD METRAL 1000 APPL.) AND 2.30 (3.30) - 5.30 FOR METRAL 4000 RECEPTACLE APPLICATION
		1	2	3	4	5	6	
74817-X024 *RPU SEE NOTE 15 LEAD FREE OPTION	E	05	05	05	05	05	05	
	D	05	05	05	05	05	05	
	C	05	05	05	05	05	05	
	B	05	05	05	05	05	05	
	A	05	05	05	05	05	05	
GND	01	01	01	01	01	01		

METRAL P/N	ROW	CONTACT CODE					
		1	2	3	4	5	6
74817-X025 ** SEE NOTE 15 LEAD FREE OPTION	E	01	19	01	01	01	01
	D	01	19	01	01	01	01
	C	01	19	01	01	01	01
	B	01	19	01	01	01	01
	A	01	19	01	01	01	01
GND	01	01	01	01	01	01	

METRAL P/N	ROW	CONTACT CODE						PCB THICKNESS RANGE FOR REAR PLUG UP APPL. : 3.80 - 6.80 FOR METRAL 1000 RECEPTACLE APPL. (NOT A STANDARD METRAL 1000 APPL.) AND 2.30 (4.80) - 6.80 FOR METRAL 4000 APPLICATIONS
		1	2	3	4	5	6	
74817-X026 *RPU SEE NOTE 15 LEAD FREE OPTION	E	02	02	49	49	49	49	
	D	02	02	49	49	49	49	
	C	02	02	49	49	49	49	
	B	02	02	49	49	49	49	
	A	02	02	49	49	49	49	
GND	01	01	01	01	01	01		

METRAL P/N	ROW	CONTACT CODE						PCB THICKNESS RANGE FOR REAR PLUG UP APPL. : 3.80 - 6.80 FOR METRAL 1000 RECEPTACLE APPL. (NOT A STANDARD METRAL 1000 APPL.) AND 2.30 (4.80) - 6.80 FOR METRAL 4000 APPLICATIONS
		1	2	3	4	5	6	
74817-X027 *RPU SEE NOTE 15 LEAD FREE OPTION	E	49	49	49	49	02	02	
	D	49	49	49	49	02	02	
	C	49	49	49	49	02	02	
	B	49	49	49	49	02	02	
	A	49	49	49	49	02	02	
GND	01	01	01	01	01	01		

METRAL P/N	ROW	CONTACT CODE						PCB THICKNESS RANGE FOR REAR PLUG UP APPL. : 3.80 - 6.80 FOR METRAL 1000 APPLICATIONS. AND 4.80 - 6.80 FOR METRAL 4000 APPLICATIONS
		1	2	3	4	5	6	
74817-X028 *RPU SEE NOTE 15 LEAD FREE OPTION	E	49	49	49	49	49	49	
	D	49	49	49	49	49	49	
	C	49	49	49	49	49	49	
	B	49	49	49	49	49	49	
	A	49	49	49	49	49	49	
GND	01	01	01	01	01	01		

METRAL P/N	ROW	CONTACT CODE					
		1	2	3	4	5	6
74817-X029 SEE NOTE 15 LEAD FREE OPTION	E	01	01	01	01	01	01
	D	01	01	01	01	01	02
	C	01	01	01	01	01	01
	B	01	01	01	01	01	01
	A	01	01	03	01	01	03
GND	01	01	01	01	01	01	

METRAL P/N	ROW	CONTACT CODE					
		1	2	3	4	5	6
74817-X030 SEE NOTE 15 LEAD FREE OPTION	E	02	02	02	02	02	02
	D	02	02	02	02	02	02
	C	19	19	19	19	19	19
	B	02	02	02	02	02	02
	A	03	02	03	02	02	01
GND	01	01	01	01	01	01	

METRAL P/N	ROW	CONTACT CODE					
		1	2	3	4	5	6
74817-X031 SEE NOTE 15 LEAD FREE OPTION	E	02	02	02	02	02	02
	D	02	02	02	02	02	02
	C	19	19	19	19	19	19
	B	02	02	02	02	02	02
	A	01	03	02	03	02	02
GND	01	01	01	01	01	01	

METRAL P/N	ROW	CONTACT CODE					
		1	2	3	4	5	6
74817-X032 SEE NOTE 15 LEAD FREE OPTION	E	02	02	02	02	02	02
	D	02	02	02	02	02	02
	C	19	19	19	19	19	19
	B	02	02	02	02	02	02
	A	02	02	02	02	02	01
GND	01	01	01	01	01	01	

METRAL P/N	ROW	CONTACT CODE					
		1	2	3	4	5	6
74817-X033 SEE NOTE 15 LEAD FREE OPTION	E	02	02	02	02	02	02
	D	02	02	02	02	02	02
	C	19	19	19	19	19	19
	B	02	02	02	02	02	02
	A	01	02	02	02	02	03
GND	01	01	01	01	01	01	

mat'l code		SEE NOTE 5		tolerances unless otherwise specified		CUSTOMER		FCI		www.fciconnect.com	
lfr	ecr no.	dr	date	linear	0.X ± 0.3	projection	COPY	title	VERTICAL SIGNAL HDR 5 ROW P.F. 30 POS. SELECT LOAD STD.		
AW				angles	0.XX ± 0.13			product family	METRAL 1000		code
				dr	.XXX ± .051			size	dwg no		213
				enr	0° ± 2°	scale	2:1	A	74817		sheet
				ctr	K. BELL 2000-03-29						6
				oppd	M. HAHN 2000-03-29						
sheet index	revision	sheet									

PDM: Rev:AW

STATUS:Released

Printed: Feb 20, 2010

cage code 22526



This document is the property of and embodies CONFIDENTIAL and PROPRIETARY information of FCI. No part of the information shown on this document may be used in any way or disclosed to others without the written consent of FCI. Copyright FCI.

METRAL P/N	ROW	CONTACT CODE					
		1	2	3	4	5	6
74817-X034 *RPU ** SEE NOTE 15 LEAD FREE OPTION	E	05	20	05	05	05	05
	D	05	20	05	05	05	05
	C	05	20	05	05	05	05
	B	05	20	05	05	05	05
	A	05	20	05	05	05	05
GND	01	01	01	01	01	01	

PCB THICKNESS RANGE FOR REAR PLUG UP APPL.: 2.30 (2.95) - 5.30 (NOT A STANDARD METRAL 1000 APPLICATION). CANNOT BE MATED TO A METRAL 4000 RECEPTACLE.

METRAL P/N	ROW	CONTACT CODE					
		1	2	3	4	5	6
74817-X039 ** SEE NOTE 15 LEAD FREE OPTION	E	01	01	01	01	01	01
	D	01	01	01	01	01	01
	C	01	01	01	01	01	01
	B	01	01	01	01	01	01
	A	01	04	01	01	01	01
GND	01	01	01	01	01	01	

PCB THICKNESS RANGE FOR REAR PLUG UP APPLICATIONS: 4.00 - 5.30. CANNOT BE MATED TO A METRAL 4000 RECEPTACLE.

METRAL P/N	ROW	CONTACT CODE					
		1	2	3	4	5	6
74817-X044 *RPU ** SEE NOTE 15 LEAD FREE OPTION	E	45	45	45	45	45	45
	D	45	45	45	45	22	45
	C	45	45	45	45	45	45
	B	45	45	45	45	45	45
	A	47	47	47	47	47	47
GND	22	22	22	22	22	22	

PCB THICKNESS RANGE FOR REAR PLUG UP APPL.: 2.95 - 3.80 FOR MATING TO METRAL 1000 RECEPTACLE. CANNOT BE MATED TO METRAL 4000 RECEPTACLES.

- * REAR PLUG-UP PART NUMBER WITH PIN ALIGNER
- ** CANNOT BE MATED TO A METRAL 4000 RECEPTACLE
- *** REAR PLUG-UP PART NUMBER WITHOUT PIN ALIGNER

mat'l code		SEE NOTE 5		tolerances unless otherwise specified		CUSTOMER		FCI		www.fciconnect.com	
lfr	ecr no.	dr	date	linear	0.X ± 0.3	projection	COPY	title	VERTICAL SIGNAL HDR 5 ROW P.F. 30 POS. SELECT LOAD STD.		
AW				angles	.xxx ± .051			product family	METRAL 1000		code
				dr	0° ± 2°		MM	size	dwg no		213
				enr	K. BELL 2000-03-29	scale	2:1	A	74817		sheet
				ctr	M. HAHN 2000-03-29						7
				oppd	M. HAHN 2000-03-29						
sheet index	revision	sheet									



This document is the property of and embodies CONFIDENTIAL and PROPRIETARY information of FCI. No part of the information shown on this document may be used in any way or disclosed to others without the written consent of FCI. Copyright FCI.

METRAL P/N	ROW	CONTACT CODE					
		1	2	3	4	5	6
74817-X049 SEE NOTE 15 LEAD FREE OPTION	E	02	02	02	02	02	02
	D	02	02	02	02	02	02
	C	04	02	02	02	02	02
	B	02	02	02	02	02	02
	A	02	02	02	02	02	02
GND	02	02	02	02	02	02	

METRAL P/N	ROW	CONTACT CODE					
		1	2	3	4	5	6
74817-X050 ** SEE NOTE 15 LEAD FREE OPTION	E	02	02	02	02	02	04
	D	02	02	02	02	02	04
	C	02	02	02	02	02	04
	B	02	02	02	02	02	04
	A	02	01	02	02	02	04
GND	02	02	02	02	02	02	

METRAL P/N	ROW	CONTACT CODE					
		1	2	3	4	5	6
74817-X051 ** SEE NOTE 15 LEAD FREE OPTION	E	04	02	02	02	02	02
	D	04	02	02	02	02	02
	C	04	02	02	02	02	02
	B	04	02	02	02	02	02
	A	04	01	02	02	02	02
GND	02	02	02	02	02	02	

METRAL P/N	ROW	CONTACT CODE					
		1	2	3	4	5	6
74817-X052 ***RPU SEE NOTE 15 LEAD FREE OPTION	E	05	05	05	05	05	05
	D	05	05	05	05	05	05
	C	05	05	05	05	05	05
	B	05	05	05	05	05	05
	A	05	05	05	05	05	05
GND	01	01	01	01	01	01	

METRAL P/N	ROW	CONTACT CODE					
		1	2	3	4	5	6
74817-X053 ***RPU SEE NOTE 15 LEAD FREE OPTION	E	05	20	05	05	05	05
	D	05	20	05	05	05	05
	C	05	20	05	05	05	05
	B	05	20	05	05	05	05
	A	05	20	05	05	05	05
GND	01	01	01	01	01	01	

- * REAR PLUG-UP PART NUMBER WITH PIN ALIGNER
- ** CANNOT BE MATED TO A METRAL 4000 RECEPTACLE
- *** REAR PLUG-UP PART NUMBER WITHOUT PIN ALIGNER

METRAL P/N	ROW	CONTACT CODE					
		1	2	3	4	5	6
74817-X054 ***RPU SEE NOTE 15 LEAD FREE OPTION	E	22	22	22	22	22	22
	D	22	22	22	22	22	22
	C	45	45	45	45	45	45
	B	22	22	22	22	22	22
	A	22	22	22	22	22	22
GND	01	22	22	22	22	01	

METRAL P/N	ROW	CONTACT CODE					
		1	2	3	4	5	6
74817-X055 ** SEE NOTE 15 LEAD FREE OPTION	E	04	02	02	02	02	02
	D	04	02	02	02	02	02
	C	04	02	02	02	02	02
	B	04	02	02	02	02	02
	A	04	02	02	02	02	02
GND	-	02	02	02	02	-	

METRAL P/N	ROW	CONTACT CODE					
		1	2	3	4	5	6
74817-X056 SEE NOTE 15 LEAD FREE OPTION	E	02	02	02	02	02	02
	D	02	02	02	02	02	02
	C	04	02	02	02	02	02
	B	02	02	02	02	02	02
	A	02	02	02	02	02	02
GND	-	02	02	02	02	-	

METRAL P/N	ROW	CONTACT CODE					
		1	2	3	4	5	6
74817-X057 *RPU SEE NOTE 15 LEAD FREE OPTION	E	22	22	22	01	01	01
	D	22	22	22	01	01	01
	C	22	22	22	01	01	01
	B	22	22	22	01	01	01
	A	22	22	22	01	01	01
GND	22	22	22	22	22	22	

mat'l code: SEE NOTE 5		tolerances unless otherwise specified		CUSTOMER		FCI www.fciconnect.com	
lfr	ecm no.	dr	date	linear	projection	title	
AW				0.XX ±0.13	MM	VERTICAL SIGNAL HDR 5 ROW	
				.XXX ±.051	scale	P.F. 30 POS. SELECT LOAD STD.	
				angles	2:1	product family METRAL 1000	
				dr K. BELL 2000-03-29		code	
				engr J. VOLSTORF 2001-05-23		213	
				chr M. HAHN 2000-03-29		sheet	
				appd M. HAHN 2000-03-29		8	
sheet index	revision sheet					cage code	
						22526	

PDM: Rev:AW

STATUS:Released

Printed: Feb 20, 2010

PRODUCT NUMBER
SEE SHEET 1

NOTES:

- SEE APPLICATION SPECIFICATION GS-20-010 FOR INFORMATION ON AVAILABLE TOOLING, CIRCUIT BOARD DESIGN CONSIDERATIONS, REPAIR PROCEDURES AND PRODUCT OFFERINGS.
- SEE FC1 PUBLICATION 950511-028 FOR "ELECTRICAL PERFORMANCE DATA FOR DIFFERENTIAL APPLICATIONS."
- SEE FC1 PUBLICATION 950511-029 FOR "ELECTRICAL PERFORMANCE DATA FOR SINGLE-ENDED APPLICATION."
- UNLESS OTHERWISE SPECIFIED, ALL DIMENSIONS AND TOLERANCES ARE IN ACCORDANCE WITH ASME Y14.5, 1994
- HOUSING MATERIAL: LIQUID CRYSTAL POLYMER, 30% GLASS FILLED, FLAME RETARDANT PER UL 94-V0.
PIN MATERIAL: PHOSPHOR BRONZE
GROUND SPRING MATERIAL: PHOSPHOR BRONZE
- PLATING INFORMATION: PLATING ON CONTACT AREA MEETS THE PERFORMANCE LEVELS SHOWN IN TABLE ON SHEET 1. PLATING OF "LF" TAILS IS Sn. PLATING ON ALL OTHER TAILS IS SnPb.
- DIMENSIONAL RESTRICTIONS OF PINS IN HEADERS.
FOR MATING WITH METRAL 1000 RECEPTACLES
DIM A : 5.00mm MIN, 8.00mm MAX FOR ROWS A-E
DIM A : 5.00mm MIN, 5.75mm MAX FOR ROW GND NEXT TO ROW A
DIM C : 5.00mm MIN, 8.00mm MAX FOR ROWS A-E
DIM C : 4.60mm MIN, 6.30mm MAX FOR ROW GND NEXT TO ROW A
FOR MATING WITH METRAL 4000 RECEPTACLES
DIM A : 5.00mm MIN, 6.50mm MAX FOR ROWS A, B, D & E
DIM A : 5.00mm MIN, 8.00mm MAX FOR ROW C
DIM A : 5.00mm MIN, 5.75mm MAX FOR ROW GND NEXT TO ROW A
DIM C : 5.00mm MIN, 7.00mm MAX FOR ROWS A, B, D & E
DIM C : 5.00mm MIN, 8.00mm MAX FOR ROW C
DIM C : 4.60mm MIN, 6.30mm MAX FOR ROW GND NEXT TO ROW A

- THE MIN PCB THICKNESS FOR REAR PLUG-UP APPLICATIONS IS 2.9mm SINCE THE COMPLAINT SECTIONS OF THE GROUND SPRING OF THE HEADER DIRECTLY OPPOSE THE GROUND SPRING OF THE SHROUD. THE MIN PCB THICKNESS FOR FRONT PLUG-UP ONLY APPLICATIONS IS 1.6mm.
- THESE HOLES ARE NEEDED FOR REAR PLUG-UP DESIGNS USING A SHROUD AND MAY BE OMITTED FOR FRONT PLUG-UP ONLY DESIGNS.
- THE 'CONNECTOR OUTLINE' IS THE MIN OUTLINE REQUIRED. TO DETERMINE THE OUTLINE NECESSARY TO PERMIT THE VARIOUS TYPES OF REPAIR OPERATIONS, SEE APPLICATION SPECIFICATION GS-20-010.
- CURRENT RATING: 1 AMP PER PIN
- TEMPERATURE RANGE: -55°C TO +105°C
- P/N 74817-XZZZLF

 - LEAD FREE (OPTIONAL)
 - SELECT LOAD PATTERN
 - PLATING CODE
- THE PRODUCTS WHERE THE PART NUMBERS ENDS IN LF MEET EUROPEAN UNION DIRECTIVES AND OTHER COUNTRY REGULATIONS AS DESCRIBED IN GS-22-008. ALL PRODUCTS WILL WITHSTAND EXPOSURE TO 260°C FOR 60 SECONDS IN A CONVECTION, INFRA-RED OR VAPOR PHASE REFLOW OVEN.
- FOR LEAD FREE PART NUMBERS ADD 'LF' SUFFIX.
EXAMPLE: 74817-XYYYLF
- PIN TYPE IS AT THE MANUFACTURERS OPTION AND CAN BE EITHER BABY-H OR EYE OF THE NEEDLE STYLE

mat'l code SEE NOTE 5				tolerances unless otherwise specified		CUSTOMER		FCJ www.fciconnect.com	
ltr	ecm no.	dr	date	linear	0. XX ±0.13	COPY		title	
AW				angles	.XXX ±.051	projection		VERTICAL SIGNAL HDR 5 ROW	
				dr	0° ±2°	MM		P.F. 30 POS. SELECT LOAD STD.	
				engr	K. BELL 2000-03-29	product family		METRAL 1000	
				chr	M. HAHN 2000-03-29	size		code	
				appd	M. HAHN 2000-03-29	scale		213	
						A		sheet	
sheet index	revision sheet					74817		9	

This document is the property of and embodies CONFIDENTIAL and PROPRIETARY information of FCJ. No part of the information shown on this document may be used in any way or disclosed to others without the written consent of FCJ. Copyright FCJ.