

PRODUCT NUMBER  
SEE TABLE

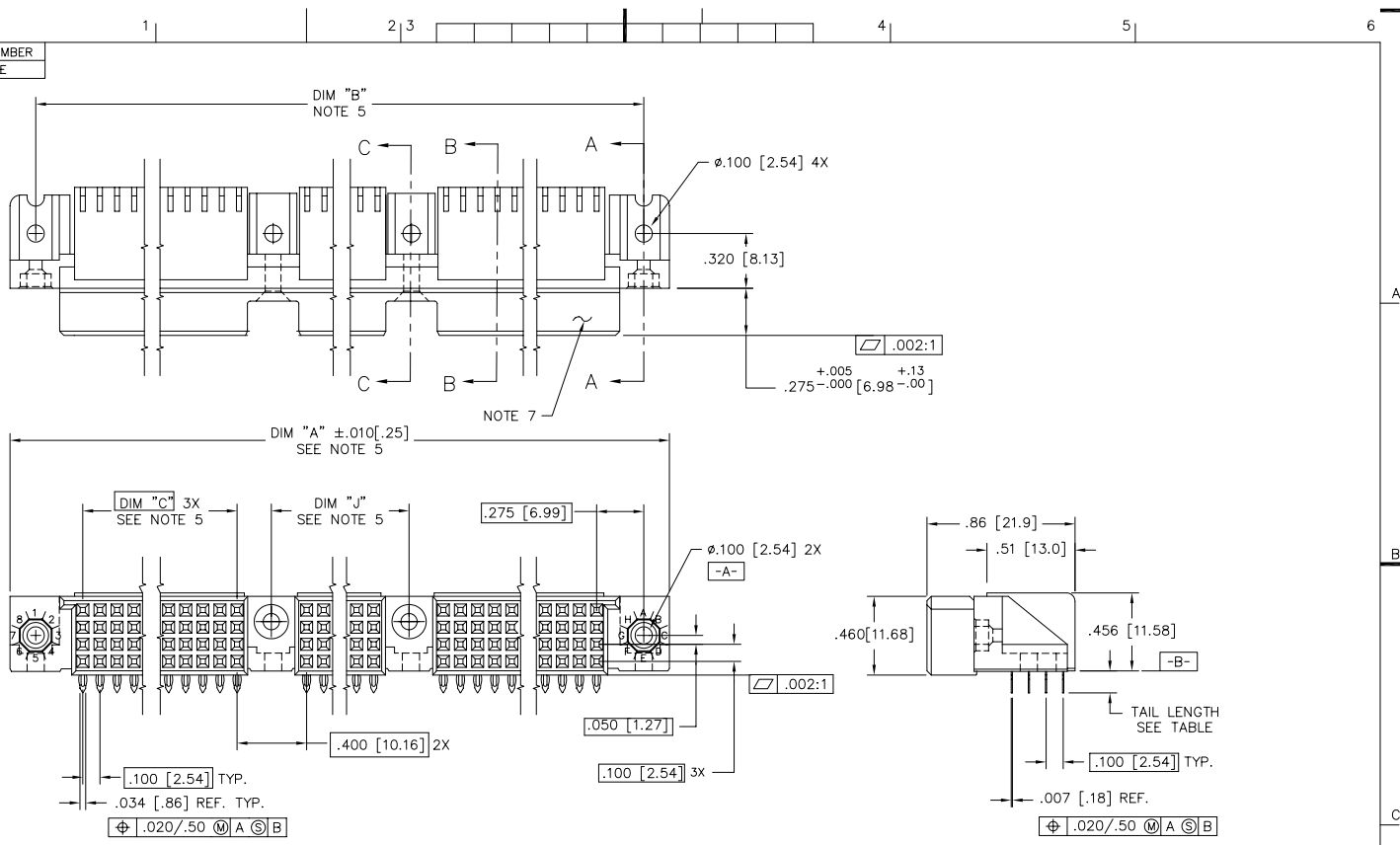

mat'l. code SEE NOTE 3	surface ISO 1302 ✓	tolerance ISO 406 ISO 1101	projection INCH/MM	product family HPC
itr N v10820 JRW 2/1/01	tolerances unless otherwise specified	angles linear .XXX±.005/.13	scale 1:1	title 4 ROW R/A RECEPTACLE PRESS FIT, 2 GUIDE PINS
P v10947 CGD 2/28/01	0'±2'	linear .XXXX±.0020/.005		sheet 1 of 6 size
R v10960 MEM 3/14/01				50644 A3
S v05-0512 DAL 8/01/05	dr G.PETERS 6/12/93			type Product Customer Drawing
T v05-1054 HTB 11/16/05	enrg S.CLARK 6/12/93			
U v06-0283 MHT 7/27/06	chr S.CLARK 6/12/93			
V v07-0099 AGS 2/08/07	appd S.CLARK 6/12/93			
sheet index	revision v v v v v v			
	sheet 1 2 3 4 5 6			

PDM: Rev:V STATUS:Released Printed: Feb 20, 2010

PRODUCT NUMBER  
SEE TABLE

NOTES:

- ① PRODUCT NUMBERING CODE:  
50644 - X YYY Z S LF  
  - LEAD FREE (OPTIONAL)
  - SPECIAL FEATURES (NOTE 10)
  - TAIL LENGTH (SEE TABLE)
  - NO. OF POSITIONS (NOTE 2)
  - PLATING SEE TABLE
  - BASE NUMBER
- PRODUCT NUMBERING CODE FOR SELECT LOAD  
50644- XX YYY LF  
  - LEAD FREE (OPTIONAL)
  - SEQUENCE NUMBER
  - ALWAYS "XX"
  - BASE NUMBER
- ② THIS PRODUCT IS CONFIGURED IN SIZES OF 30 thru 150 COLUMNS IN INCREMENTS OF THREE.  
i.e.: 30,33,36,.....147,150.
- ③ MATERIAL PRESS BLOCK: HIGH TEMP. THERMOPLASTIC  
MATERIAL HOUSING: GLASS AND MINERAL FILLED  
HIGH TEMP. THERMOPLASTIC, FLAME RETARDANT  
PER UL94V-0. COLOR: BLACK.  
CONTACT MATERIAL: BeCu.
4. PLATING:  
CONTACT AREA - SEE PRODUCT NUMBER TABLE  
TAILS-EITHER TIN OR TIN LEAD, SEE PRODUCT NUMBER TABLE
- ⑤ DIMENSION "A" CALCULATION =  $.100 (2.54) \times \text{NO. OF COLUMNS} + 1.35[34.3]$   
DIMENSION "B" CALCULATION =  $.100 (2.54) \times \text{NO. OF COLUMNS} + 1.05[26.67]$   
DIMENSION "C" CALCULATION =  $.100 (2.54) \times \text{NO. OF COLUMNS} - \text{DIVIDED BY } 3 - .100[2.54]$   
DIMENSION "J" CALCULATION =  $.100 (2.54) \times \text{NO. OF COLUMNS} - \text{DIVIDED BY } 3 + .300[7.62]$
- ⑥ DRILLED HOLE DIA. OF  $.0453 \pm .001$  FINISHED TO  $.0400 \pm .0030$   
BY PLATING SnPb(60/40),  $.0003 - .0006$  w/Cu  
UNDERPLATING AS NEEDED.
- ⑦ MANUFACTURE'S LOGO, P/N, AND LOT CODE TO APPEAR ON THIS SURFACE.
8. THIS HOUSING WILL WITHSTAND EXPOSURE TO 260°C PEAK TEMPERATURE FOR 10-30 SECONDS IN A CONVECTION, INFRA-RED OR VAPOR PHASE REFLOW OVEN.
- ⑨ FOR PCB STAY AWAY ZONE SEE TA-0954.
- ⑩ SPECIAL FEATURES:  
- = IF NO SPECIAL FEATURE CODE IS SELECTED, CONNECTOR WILL APPEAR AS SHOWN. PCB MOUNTING HOLE DIMENSION TO BE  $\phi.120 \pm .003 [3.05 \pm 0.07]$   
"A" = IF SPECIFIED, CONNECTOR WILL APPEAR AS SHOWN ON SHEET 3. PCB MOUNTING HOLE DIMENSION TO BE  $\phi.100 \pm .003 [2.54 \pm 0.07]$   
"B" = IF SPECIFIED, CONNECTOR WILL HAVE PRE-INSTALLED EYELET FOR P.C.B. ATTACHMENT IN A  $\phi.100 \pm .003 [2.54 \pm 0.07]$  MOUNTING HOLE. SEE SHEET 3. (AVAILABLE IN "E" TAIL LENGTH ONLY).  
"C" = IF SPECIFIED, CONNECTOR WILL HAVE PRE-INSTALLED EYELET FOR P.C.B. ATTACHMENT IN A  $\phi.120 \pm .003 [2.54 \pm 0.07]$  MOUNTING HOLE. SEE SHEET 3.  
"D" = IF SPECIFIED, CONNECTOR WILL HAVE PRE-INSTALLED EYELET WITH MOLDED GUIDE PINS FOR P.C.B. ATTACHMENT IN A  $\phi.120 \pm .003 [2.54 \pm 0.07]$  MOUNTING HOLE. SEE SHEET 3.
- ⑪ THIS PRODUCT (WITH "LF" SUFFIX) MEETS EUROPEAN UNION DIRECTIVES AND OTHER COUNTRY REGULATIONS AS DESCRIBED IN GS-22-008.

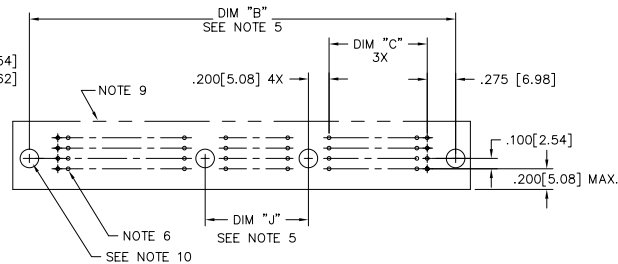
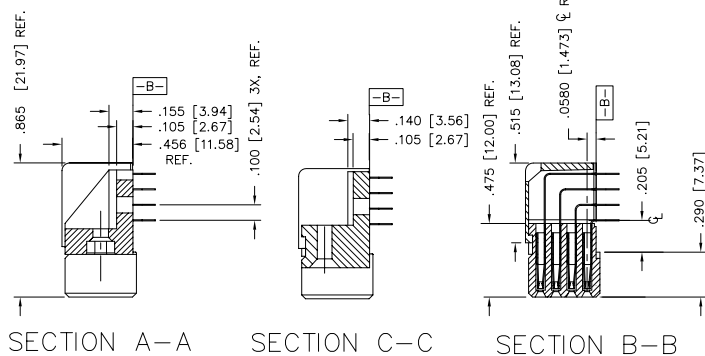

RECOMMENDED PCB LAYOUT  
(ALL HOLES LOCATED ON  $.100 [2.54]$  GRID UNLESS OTHERWISE SHOWN)

mat'l. code SEE NOTE 3	surface ISO 1302 ✓	tolerance ISO 406 ISO 1101	projection INCH/MM	product family HPC
ltr ecn no dr	date	tolerances unless otherwise specified angles linear XXX.01/3 .XXX±.005/.13 XXXX±.0020/.051	scale 1:1	title 4 ROW R/A RECEPTACLE PRESS FIT, 2 GUIDE PINS
dr	G.PETERS	6/12/93	FCJ	dwg no 50644
enrg	S.CLARK	6/12/93		sheet2 of 6 size A3
chr	S.CLARK	6/12/93		type Product Customer Drawing
appd	S.CLARK	6/12/93		
sheet index	revision sheet			

PRODUCT NUMBER  
SEE TABLE

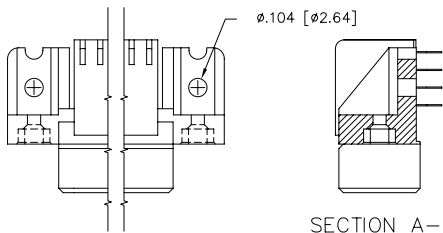

SPECIAL FEATURE OPTION A

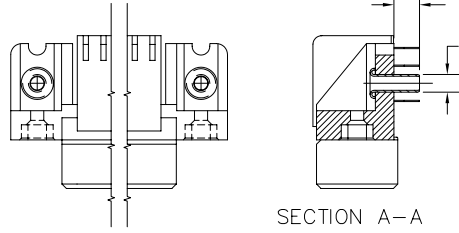

SPECIAL FEATURE OPTION B

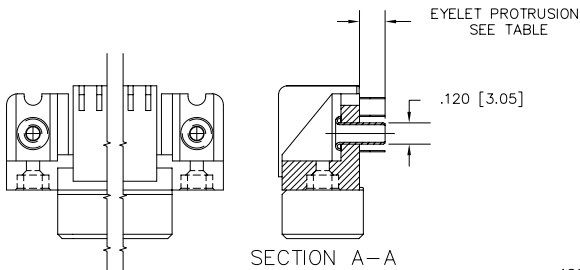

SPECIAL FEATURE OPTION C

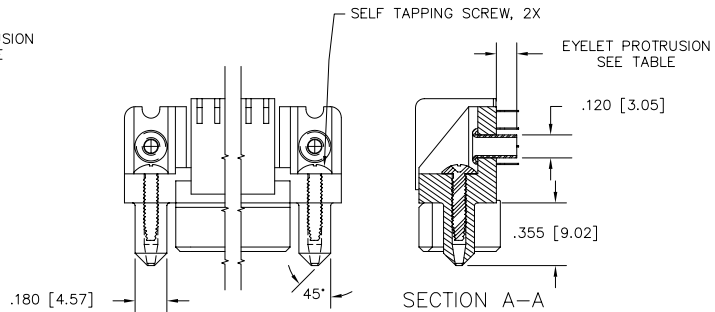

SPECIAL FEATURE OPTION D

mat'l. code		surface	tolerance	projection	product family
ISO 1302		ISO 1302	ISO 406		HPC
ISO 1101		ISO 1101	ISO 1101		
ltr	ecm	no	dr	date	title
v					4 ROW R/A RECEPTACLE PRESS FIT, 2 GUIDE PINS
angles		linear		INCH/MM	scale 1:1
0°±2'		.XXX±.01/3			
dr		G.PETERS	6/12/93	sheet 3 of 6 size	
enrg		S.CLARK	6/12/93	50644	
chr		S.CLARK	6/12/93	A3	
appd		S.CLARK	6/12/93	type Product Customer Drawing	
sheet	revision				
index	sheet				

PRODUCT NUMBER  
50644-XX001  
50644-XX001LF

50644-XX001 AND 50644-XX001LF ONLY

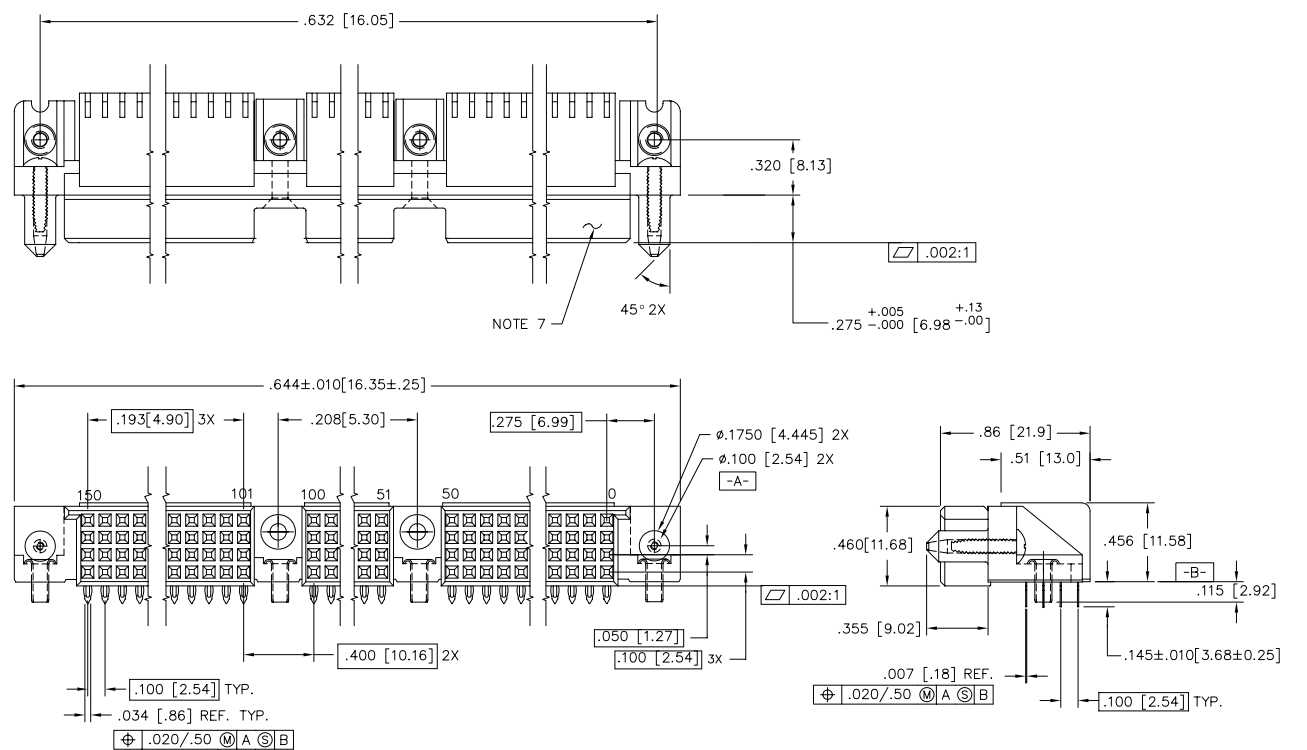

NOTES FOR -XX001 AND XX001LF ONLY:  
1. ALL POSITIONS LOADED WITH .145[3.68] TAIL LENGTH.  
2. SIZE 4 x 150  
TOTAL NUMBER OF POSITIONS - 600  
TOTAL NUMBER OF POSITIONS LOADED - 600

mat'l. code	SEE NOTE 3	surface	ISO 1302 ✓	tolerance	ISO 406	projection	product family
ltr	ecn	no	dr	date	ISO 1101		HPC
v					tolerances unless otherwise specified		title
					angles	INCH/MM	4 ROW R/A RECEPTACLE
					linear	scale 1:1	PRESS FIT, 2 GUIDE PINS
					dr	G.PETERS	6/12/93
					engr	S.CLARK	6/12/93
					chr	S.CLARK	6/12/93
					appd	S.CLARK	6/12/93
sheet	revision						
index	sheet						

PDM: Rev:V STATUS:Released Printed: Feb 20, 2010

PRODUCT NUMBER
50644-XX002
50644-XX002LF

50644-XX002 AND 50644-XX002LF ONLY

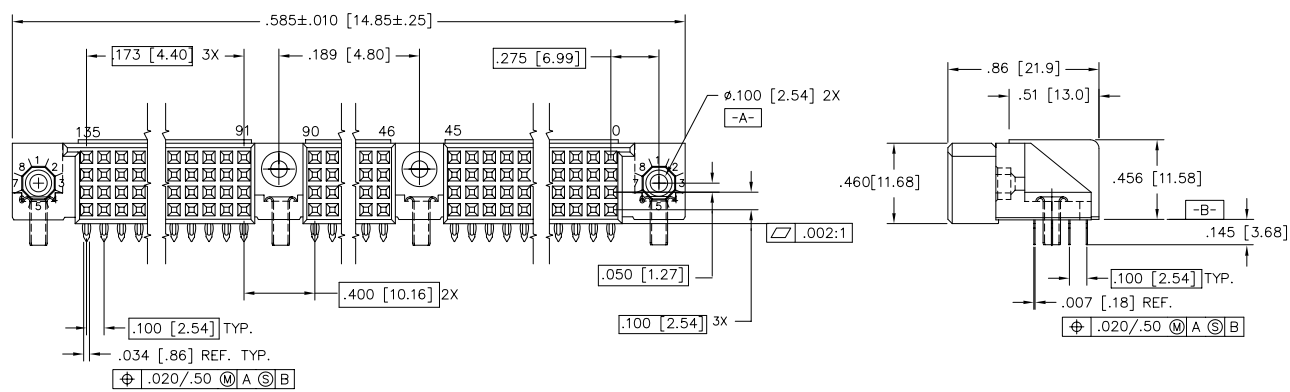
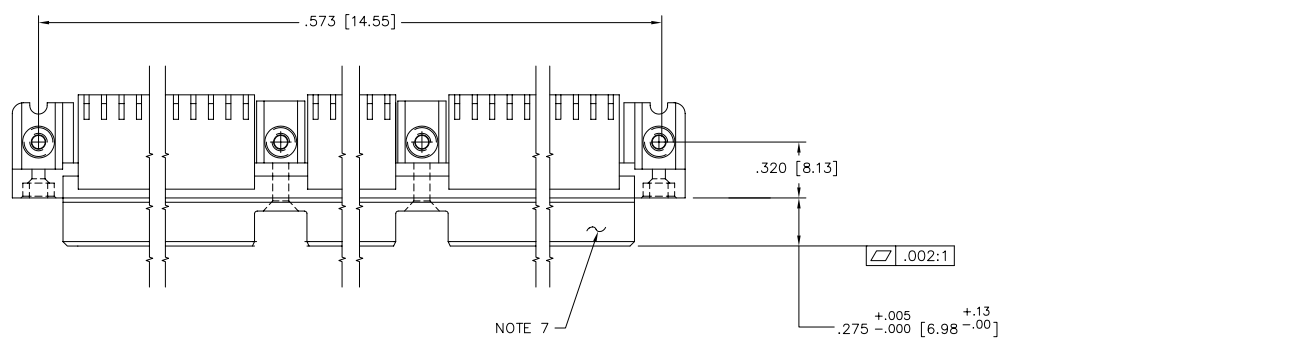

NOTES FOR -XX002 AND XX002LF ONLY:  
 1. ALL POSITIONS LOADED WITH .145[3.68] TAIL LENGTH.  
 2. SIZE 4 x 135  
 TOTAL NUMBER OF POSITIONS - 540  
 TOTAL NUMBER OF POSITIONS LOADED - 540

mat'l. code	surface ISO 1302	tolerance ISO 406 ISO 1101	projection 	product family HPC
ltr	ecn	no	dr	date
v	tolerances unless otherwise specified			
	angles	linear	.XX±.01/.3 .XXX±.005/.13 XXXX±.0020/.051	
	dr	G.PETERS	6/12/93	
	enrg	S.CLARK	6/12/93	
	chr	S.CLARK	6/12/93	
	appd	S.CLARK	6/12/93	
sheet index	revision sheet			
		scale 1:1	INCH/MM	title 4 ROW R/A RECEPTACLE PRESS FIT, 2 GUIDE PINS
				dwg no 50644
				sheet 5 of 6 size A3
				type Product Customer Drawing

PDM: Rev:V STATUS:Released Printed: Feb 20, 2010

