



Tous droits strictement réservés. Reproduction ou communication à des tiers sans autorisation écrite du propriétaire.  
 All rights strictly reserved. Reproduction or communication to third parties in any form without written authority from the proprietor.  
 Copyright BERG ELECTRONICS BV



All rights strictly reserved. Reproduction or communication to third parties in any form without written authority from the proprietor.  
 Copyright BERG ELECTRONICS BV

PRODUCT NO.
73725

(CONTINUED)

6. P/N'S WITH SUFFIX "LF" ARE LEAD FREE P/N'S
7. FOR LEAD FREE P/N, THE PRODUCT MEET EUROPEAN UNION DIRECTIVES AND OTHER COUNTRY REGULATION AS DESCRIBED IN GS-22-008
8. FOR THE PRODUCTS WITH THE METAL SHELL PLATING NICKEL AND MATTE SN CAN WITHSTAND EXPOSURE TO 260°C PEAK TEMPERATURE FOR 40 SECONDS IN A CONVECTION, INFRA-RED OR VAPOR PHASE REFLOW PROCESS; FOR THE PRODUCTS WITH METAL SHELL PLATING BRIGHT SN OR SEMI-BRIGHT SN CAN'T WITHSTAND REFLOW AND JUST CAN WITHSTAND EXPOSURE TO 260°C PEAK TEMPERATURE FOR 10 SECONDS IN WAVE SOLDERING PROCESS.
9. FOR ALL LEAD FREE P/N'S, CHANGE TIN/LEAD PLATING TO PURE TIN PLATING
10. THE PRODUCT CAN BE USED FOR PIP PROCESS
11. DATUM OF CUSTOMER'S PCB LAYOUT.

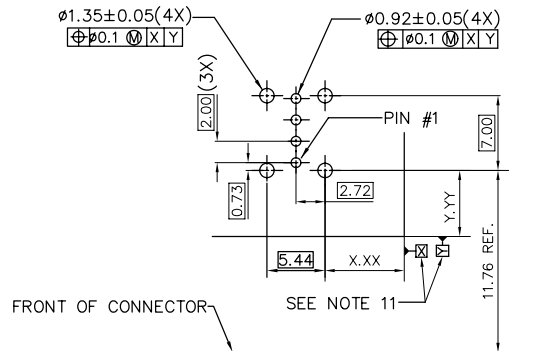
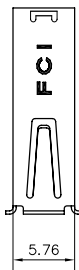

PC BOARD MOUNTING DIMENSIONS FOR 4 PIN

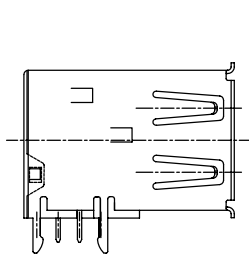

WITHOUT SENSOR CONTACT

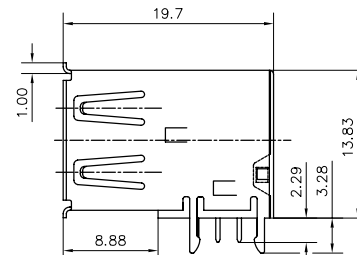
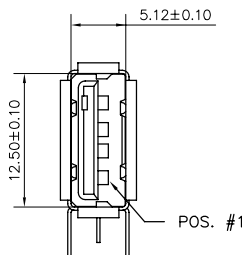

FOR 73725-X1X0B

mat'l code		tolerance unless otherwise specified		CUSTOMER COPY		FCJ www.fcjconnect.com	
rev.	ecn no.	dr	date	linear	0 ± .30	projection	title USB UP-RIGHT RECEIPT
AC	N10-0128	A.ZH	05/14/2010		.00 ± .20		
				angles	.000 ± .010	product family USB	code TWN
				dr	± 2°		
				enr	PETER PAM 9/4/97	size	sheet
				chr	R Y LIU 9/4/97	A3	2 OF 4
				appd	JENN TSAO 9/4/97	dwg no.	
sheet	revision					73725	
index	sheet						

Tous droits strictement réservés. Reproduction ou communication sans l'avis écrit du propriétaire. Toute réimpression sans autorisation écrite du propriétaire. Property of FCJ ELECTRONICS. Copyright FCJ ELECTRONICS. All rights strictly reserved. Reproduction or communication without the written authority of the proprietor. Copyright FCJ ELECTRONICS.



All rights strictly reserved. Reproduction or communication without the written authority of the proprietor. Property of FCJ ELECTRONICS. Copyright FCJ ELECTRONICS.

PRODUCT NO.  
73725

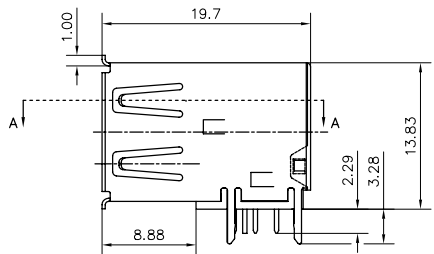
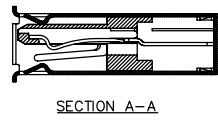
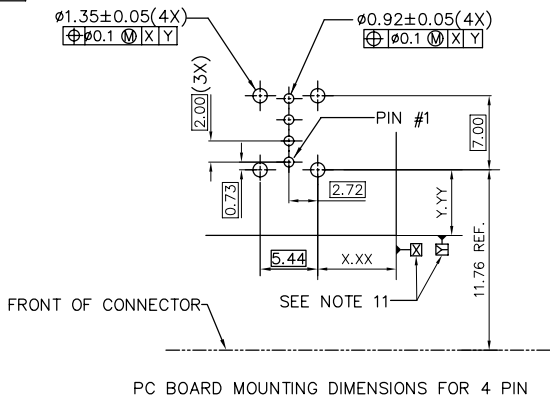

WITH SENSOR CONTACT  
FOR 73725-X0X0B  
HOLD DOWN STYLE "B"

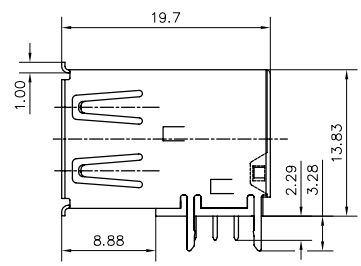

WITHOUT SENSOR CONTACT  
FOR 73725-X1X0B  
HOLD DOWN STYLE "B"

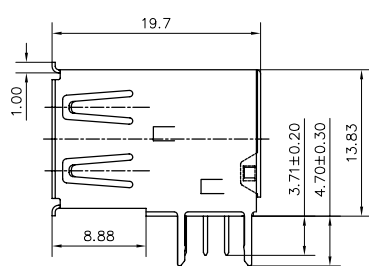

WITHOUT SENSOR CONTACT  
FOR 73725-X191XLF  
HOLD DOWN STYLE "D"

mat'l code		tolerance unless otherwise specified		CUSTOMER COPY		FCJ www.fcjconnect.com	
rev.	ecn no.	dr	date	linear	.0 ± .30	projection	title USB UP-RIGHT RECEPT
AC	N10-0128	A.ZH	05/14/2010		.00 ± .20		
				angles	.000± 0.10		product family USB
					± 2'		
		dr	PETER	5/20/97	unit		code TWN
		enagr	JOHN WEN	5/20/97	mm		
		chr	JOHN WEN	5/20/97	scale		sheet 3 OF 4
		appd	JENN TSAO	5/20/97			
sheet revision							
index sheet							

Tous droits strictement réservés. Reproduction ou communication sans autorisation écrite de BERG ELECTRONICS. Propriété de BERG ELECTRONICS. Droits de reproduction BERG ELECTRONICS by



All rights strictly reserved. Reproduction or issue to third parties in any form without the written authority from the proprietor. Property of BERG ELECTRONICS. Copyright BERG ELECTRONICS by

PRODUCT NO.  
73725

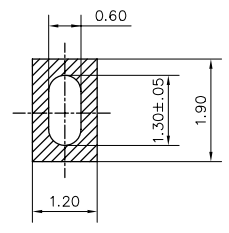
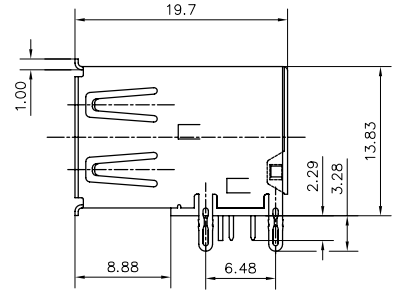
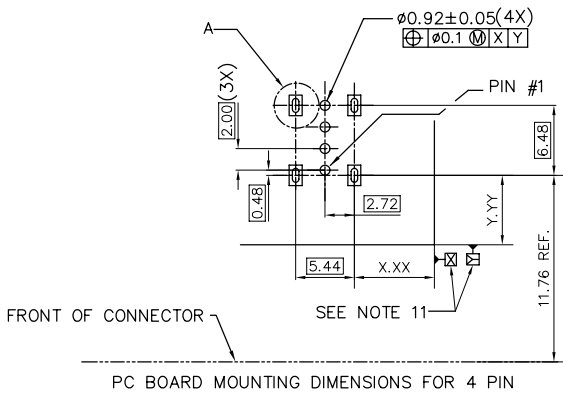

mat'l code		tolerance unless otherwise specified		CUSTOMER COPY		FCI www.fciconnect.com	
rev.	ecn no.	dr	date	linear	.0 ± .30	projection	title USB UP-RIGHT RECEPT
AC	N10-0128	A.ZH	05/14/2010		.00 ± .20		
				angles	.000 ± 0.10		product family USB
				dr	± 2°		
				engr	PETER 01/12/99	unit	code
				chr	R Y LIU 01/12/99	mm	TWN
				appd	JENN TSAO 01/12/99	scale	sheet
sheet	revision						4 OF 4
index	sheet						

PDM: Rev:AC STATUS: Released Printed: Jul 26, 2010