

Tous droits strictement réservés. Reproduction ou communication à des tiers interdite sous quelque forme que ce soit sans autorisation écrite du propriétaire. Propriété de FCI. Droits de reproduction FCI.

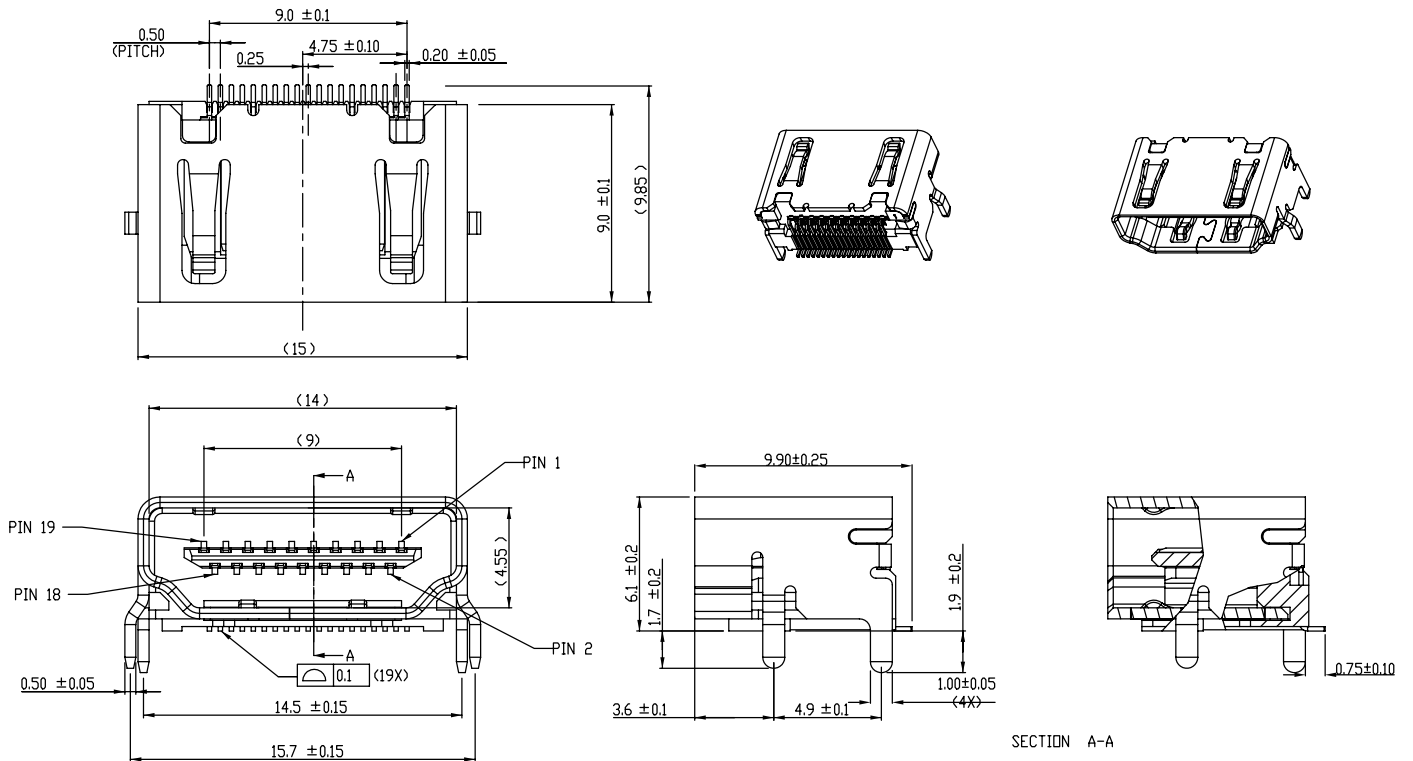

All rights strictly reserved. Reproduction or issue to third parties in any form whatever is not permitted without written authority from the proprietor. Property of FCI. Copyright FCI.

PRODUCT NO.
10029449-X01XLF



Mark with
10029449-001
REV. 1
in area indicated
by X.....

rev	ecn no	dr	date
L	N09-0159	SH	05/27/09
M	N09-0307	SH	10/21/09
N	N10-0033	SH	02/01/10

GENERAL TOLERANCE	ANGLE
±0.8	X°±
.x±0.4	X°±2°
.xx±0.2	

		www.fciconnect.com	tolerance	projection	size	Scale
Dr	LEIF SHEN	10/15/04	Product family	⊕	A4	1.000
Eng	LEIF SHEN	10/15/04	Spec ref	⊕	ECN	
Chr	PAUL WANG	10/15/04	Material	⊕		
Appr	JOSEPH HSIA	10/15/04	SEE NOTES	⊕		
title			HDMI TYPE A RECEPTACLE		10029449	Rev. N
catalog no			HDMI		CUSTOMER	sheet 1 of 4

3 PDM: Rev:N STATUS:Released 4 Printed: Aug 01, 2010

Tous droits strictement réservés. Reproduction ou communication à des tiers interdite sous quelque forme que ce soit sans autorisation écrite du propriétaire. Propriété de FCI. Droits de reproduction FCI.



All rights strictly reserved. Reproduction or issue to third parties in any form whatever is not permitted without written authority from the proprietor. Property of FCI. Copyright FCI.

PRODUCT NO.	CONTACT AREA PLATING	SHIELD FIGURE	PACKING
10029449-001TLF	30u" Au MINIMUM	WITHOUT FLANGE	TRAY
10029449-001RLF	30u" Au MINIMUM	WITHOUT FLANGE	TAPE AND REEL
10029449-101TLF	GOLD FLASH 3u" MIN	WITHOUT FLANGE	TRAY
10029449-101RLF	GOLD FLASH 3u" MIN	WITHOUT FLANGE	TAPE AND REEL
10029449-002TLF	30u" Au MINIMUM	WITH FLANGE	TRAY
10029449-002RLF	30u" Au MINIMUM	WITH FLANGE	TAPE AND REEL
10029449-002FLF	GOLD FLASH 3u" MIN	WITH FLANGE	TAPE AND REEL

NOTES:

1.MATERIAL

- 1-1 HOUSING: GLASS FIBER HIGH-TEMP. RESIN.(UL94V-0)
- 1-2 CONTACT: BRASS
- 1-3 SHELL : STEEL

2 FINISH

- 2-1 CONTACT : Ni UNDER PLATED ALL OVER 50u" MIN
CONTACT AREA SEE TABLE
- 2-2 SHELL : Ni 100u" MIN.

3 PACKAGING:

PACKAGING SPECIFICATION GS-14-939.

4.RoHS STANDARD SPECIFICATION ACCORDING TO FCI GS-22-008.

5. PARTS MEET REFLOW APPLICATION PEAK TEM. 260 DEGREE C, 10 SECONDS MAX.

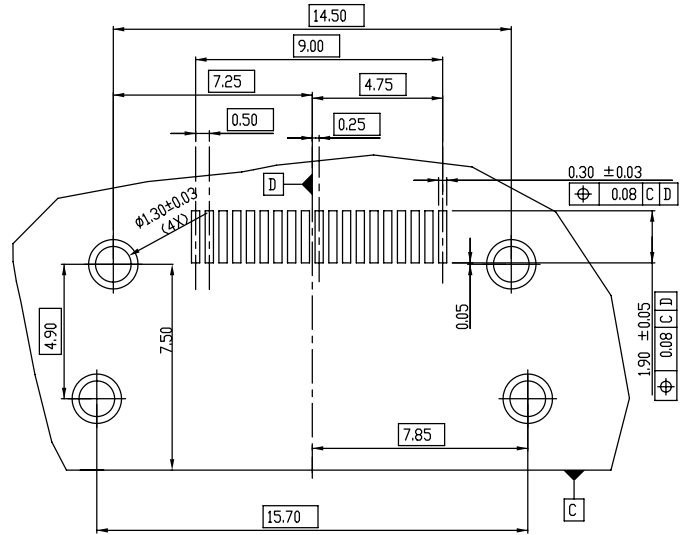

RECOMMENDED PCB PATTERN LAYOUT
(t=1.6mm)

title	HDMI TYPE A RECEPTACLE	dwg no	10029449	Rev.	N
catalog no	HDMI	*	CUSTOMER	sheet 3 of 4	

3 PDM: Rev:N

STATUS:Released

4 Printed: Aug 01, 2010

Tous droits strictement réservés. Reproduction ou communication à des tiers interdite sans quelque forme que ce soit sans autorisation écrite du propriétaire. Propriété de c FCI. Droits de reproduction FCI.



All rights strictly reserved. Reproduction or issue to third parties in any form or manner is not permitted without written authority from the proprietor. Property of FCI. Copyright FCI.

PRODUCT NO.	CONTACT AREA PLATING	SHIELD FIGURE	PACKING
10029449-111RLF	GOLD FLASH 3u" MIN	WITHOUT FLANGE	TAPE AND REEL

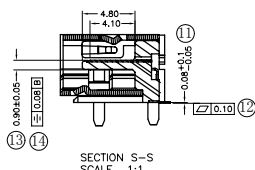
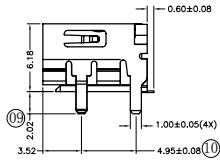
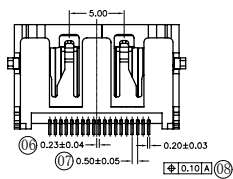
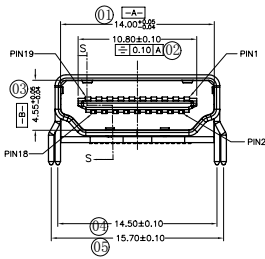
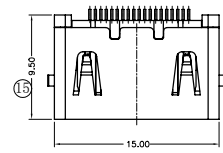

NOTE:
 1.MATERIAL:
 HOUSING: HIGH TEMP.THERMOPLASTIC, UL 94V-0
 COLOR: BLACK
 CONTACT: PHOSPHOR BRONZE
 SHIELD: BRASS
 2.FINISH:
 SEE NOTES.
 3.TERMINAL RETENTION FORCE TO BE 0.3kgf MIN.
 4.TERMINAL CUT-OFF BURR TO BE 0.05MAX.
 5.MARKED Ø DIMENSION SHOULD BE MEASURED BY QIP: * =1,2,3...

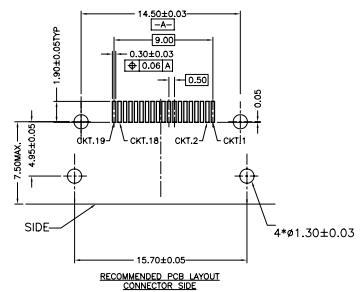

GENERAL TOLERANCE		Mark with 10029449-001 REV. 1 in area indicated		Dr LEIF SHEN 10/15/04		www.fciconnect.com		tolerance	projection	size A4	Scale 1.000
DIMENSION	ANGLE	Rev	Rev no	dr	date	Eng	LEIF SHEN 10/15/04	Product family	size A4	Scale 1.000	
.±0.8	X*±	L	N09-0159	SH	05/27/09	Chr	PAUL WANG 10/15/04	Spec ref	* ECN		
.x±0.4	X*±2°	M	N09-0307	SH	10/21/09	Appr	JOSEPH HSIA 10/15/04	Material	SEE NOTES		
.xx±0.2		N	N10-0033	SH	02/01/10						
Title HDMI TYPE A RECEPTACLE								DWG no 10029449		Rev N	
catalog no								CUSTOMER		sheet 4 of 4	