

Table of Contents

Military Qualified

Introduction 7003

N Series Connectors MIL-C-39012

 50 Ohm 7004, 7005

BNC Connectors MIL-C-39012

 50 Ohm 7006, 7007

TNC Connectors MIL-C-39012

 50 Ohm 7008, 7009

SMA Connectors MIL-C-39012

 Introduction 7010-7012

 For Flexible Cable 7013-7016

 Panel Mount 7017

 For Semi-Rigid Cable 7018-7020

 Printed Circuit Mount 7021

In-Series Adapters MIL-A-55339 7021

SMA Receptacles MIL-C-83517

 Panel Mount 7022-7024

 Surface Launch 7025

 End Launch 7026

 Field Replaceable Launchers 7027

DSCC Approved

SMA Series for Semi-Rigid Cable 7028

SSMA Connectors for Semi-Rigid and Flexible Cable 7029

BMA Blindmate Connectors for Semi-Rigid and Flexible Cable 7030

OSMP Microminiature Push-On Coaxial Connectors for Semi-Rigid Cable 7031

Between Series Adapters for Semi-Rigid and Flexible Cable 7032, 7033

Coaxial Cable Termination

One-Step BNC/TNC Connectors 7034-7039

OSMP Microminiature Push-On Coaxial Connectors

Introduction 7040, 7041

Jacks 7042

Shrouds 7043, 7044

Between Series Adapters 7044

OSMM Microminiature Connectors

Introduction 7045, 7046

For Flexible and Semi-Rigid Cables 7047

SSMA Subminiature Coaxial Connectors

Introduction 7048-7050

For Semi-Rigid Cable 7051

For Flexible Cable 7052

Panel Mount Receptacles 7053

Bulkhead Mount Receptacles 7053

Panel Mount Receptacles 7054

Printed Circuit Boards 7054

Microstrip Transmission Line Circuits 7054

Hermetically Sealed 7055, 7056

RF Connectors

Table of Contents (Continued)

SSMA Subminiature Coaxial Connectors (continued)

In-Series Adapters 7057
 High Frequency for Semi-Rigid Cable 7058

Application Tooling 7059-7064

Cross Reference 7065-7068

MICRODOT Coaxial Connectors

Introduction 7069

Standard Connectors

Performance Data Summary 7070
 Screw-On Series 7071-7076
 Slide-On Series 7077-7091
 Quick-Connect Series 7081-7083
 Twinax Series 7084
 Triax Series and Terminals 7085
 Module Blocks 7086
 Caps for Screw-On Series, Receptacle Hoods 7087
 Feed Thru Adapters for Screw-On Series 7088
 BNC and TNC Adapters for Screw-On, Slide-On, Quick-Connect Series .. 7088, 7089

Gold Plated Crimp Style Coaxial Connector Series

Performance Data Summary 7090
 Screw-On Series 7091-7094
 Assembly Tools 7094

LEPRA/CON Ultra-Miniature Connectors

Performance Data Summary 7095
 Screw-On Series — Standard Interface 7096, 7097
 Screw-On Series — Locking Interface 7098, 7099
 Slide-On Series 7100, 7101
 Assembly Tools 7101
 BNC / LEPRA/CON Adapters 7102, 7103
 Snap-Lock Series 7104

Cable Assemblies 7105, 7106

Cable Acceptance Dimensions 7107-7112

Hermetic Connectors

Coaxial Screw-On, Slide-On Series 7113, 7114

Appendix

A - Theory and Application 7115-7120
 B - Typical Coaxial Cable Specifications 7121-7123
 C - Maximum Power Handling Capabilities for Cables 7124
 D - Nominal Loss Characteristics for Cables 7125

MIL-C-39012

- Defines the general requirements and tests for radio frequency (RF) connectors used with flexible RF cables and certain other types of coaxial transmission lines. It includes the following series of connectors in this catalog: N, BNC, TNC, SMA

MIL-C-55339

- Defines the performance requirements and tests for between series and within series, RF coaxial connector adapters. The In-Series Adapters are shown in this catalog

MIL-C-83517

- Defines the general requirements and test for RF connectors used with coaxial, strip, or microstrip transmission line devices. It includes the SMA Receptacles as shown in this catalog



Definition of Categories for MIL-C-39012

Category A — Flexible Cable

Field serviceable, no special tools required to assemble. Standard wrenches, soldering equipment, pliers, etc., are not defined as special tools. Captured center contact.

Category B — Flexible & Semi-Rigid Cable

Non-field replaceable, special tools may be required. These connectors may be used for original installations. Field replacement is intended to be made by Category A or C Connectors. Will not be stocked or procured by the Government. Captured and non-captured center contacts.

Category C — Flexible Cable

Field replaceable. Requires crimp tool and specified cable stripping dimensions. Captured center contact. Recommended crimp tool kit: Part Number 1055236-1.

Category D — Flexible Cable

Field replaceable. Requires crimp tool for center contact and outer ferrule; specified cable stripping dimensions (same as Category C) and defined piece parts. Captured center contact. Recommended crimp tool kit: Part Number 1055236-1.

Category E — Semi-Rigid Cable

Field replaceable. Requires specified cable stripping dimensions. Captured and non-captured center contact. Uses standard tool kit: Part Number 1055420-1.

Category F — Semi-Rigid Cable

Field replaceable. Requires crimp tool and specified cable stripping dimensions. Captured center contact. Recommended crimp tool kit: Part Number 1055835-1.

N Series Connectors MIL-C-39012 — 50 Ohm

Product Facts

- Dual "O" Crimp connectors are MIL-C-39012, Class II, Category B qualified
- Captive center contacts
- Completely crimpable application – one hand tool crimps all cables with single or double braided shields of a given size
- Impedance matching crimps
- Broad band performance – low VSWR
- Superior cable retention
- TEFLON dielectric
- Silver finish

The AMP N MIL-C-39012 Connector, featuring a .625 [15.88] - 24 threaded coupling for optimum stability, is highly suited for critical applications and environments. This medium sized connector can withstand shock and vibration for a low noise level and has a constant impedance of 50 ohms. It also features a captive center contact and provides excellent performance at frequencies up to 11 GHz, with voltages to 1000 volts rms.

This connector offers the added benefits of low overall applied cost with a labor-saving two-crimp assembly. The contact is simply crimped to the cable's center conductor, then both braid and cable support are simultaneously crimped to complete the termination.

N Series Connectors are available in standard plug, jack, bulkhead jack and right-angle plug configurations.

Materials

- Brass** — QQ-B-626
- Beryllium Copper** — QQ-C-530
- Dielectric** — TEFLON
- TEFLON** — MIL-P-19468
- Copper, Annealed** — QQ-C-576
- Phosphor Bronze** — QQ-B-750
- Silicone Rubber** — ZZ-R-765

Plating

- Body** — Silver per QQ-S-365
- Center Contact** — Gold per ASTM B488, type 3, grade C

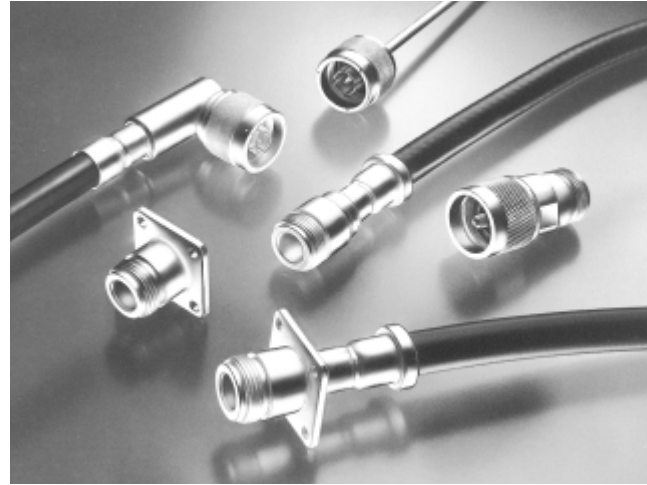

Electrical Characteristics

- Nominal Impedance** — 50 ohms
- Working Voltage** — 1000 volts, rms at sea level
- Frequency Range** — 0 to 11 GHz
- Voltage Standing Wave Ratio (VSWR)** — Straight Plug or Jack- 1.3:1 max.
Right-Angle Plug — 1.35 max. at 0 to 9.0 GHz
1.50 max. at 9.0 to 11.0 GHz
- Contact Resistance** — Outer Contact — 0.2 milliohms
Center Contact — 1.0 milliohms
Right-Angle — 2.5 milliohms
- Insulation Resistance** — 5000 megohms min.
- Dielectric Withstanding Voltage** — 2500 Volts, rms at sea level
- RF Leakage** — -90 dB min. at 2 to 3 GHz
- RF Insertion Loss** — 0.15 dB max. at 10 GHz; Right-Angle Plug, 0.3 dB max. at 10 GHz
- Corona Level** — 500 volts min. at 21 336 m [70,000 ft.]

Mechanical Characteristics

- Mating/Unmating** — Threaded coupling
- Cable Attachment** — Crimp type - center contact and braid
- Coupling Nut Retention** — 445 N [100 lbs.] min.
- Cable Retention** — 400 N [90 lbs.] min. RG 214/U Cable
- Durability** — 500 cycles per MIL-C-39012
- Captive Contact** — 27 N [6 lbs.] min. axial retention, either direction

Environmental Characteristics

- Temperature Range** — -85°F to +329°F [-65°C to +165°C]
 - Vibration** — MIL-STD-202, Method 204, Test Cond. B
 - Shock** — MIL-STD-202, Method 213, Test Cond. I
 - Moisture Resistance** — MIL-STD-202 Method 106
 - Salt Spray** — MIL-STD-202, Method 101, Test Cond B
 - Temperature Cycling** — MIL-STD-202, Method 107, Test Cond. B (except high temperature is +85°C)
- Note:** All data pertains to use with MIL-C-39012 specified cables only.

Termination Tooling

- Integral Die** — Hand Tool Part Number 220015-1

Dual Crimp Plugs
MIL-C-39012/01

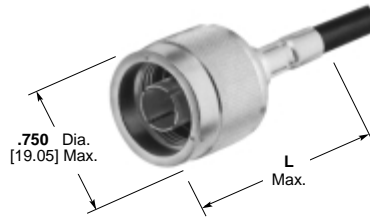

Military Part No.	AMP Part No.	Dim L	RG/U Cable
B0007 Weatherproof	225092-2	1.859 47.22	8, 8A, 213
B0007	51692-2	1.687 42.85	8,8A,213
B0013	51692-4	1.687 42.85	11, 11A, 216
B0012 Weatherproof	225092-7	1.859 47.22	225
B0008 Weatherproof	225092-1	1.859 47.22	9, 9A, 9B, 214
B0008	51692-1	1.687 42.85	9, 9A, 9B, 214

Crimp Jacks
MIL-C-39012/02



Military Part No.	AMP Part No.	RG/U Cable
B0008	225093-2	8, 8A, 213

Crimp Bulkhead Jacks
MIL-C-39012/03

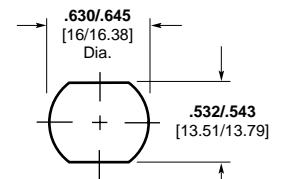
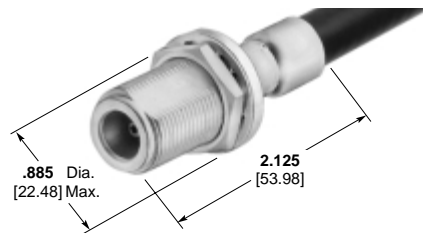

Maximum Panel Thickness .250 [6.35]
Recommended Panel Cutout

Military Part No.	AMP Part No.	RG/U Cable
B0004 Weatherproof	225094-2	8, 8A, 213
B0005 Weatherproof	225094-1	9, 9A, 9B, 214

Crimp Right-Angle Plugs
MIL-C-39012/05

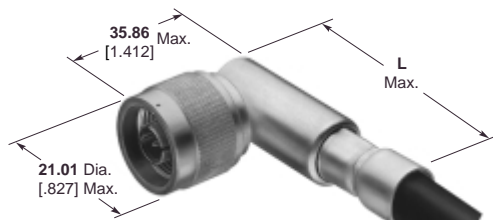

Military Part No.	AMP Part No.	Dim L	RG/U Cable
B0002	225014-2	2.275 57.79	8, 8A, 213
B0002 Weatherproof	225389-2	2.453 62.31	8, 8A, 213
B0003	225014-3	2.275 57.79	9, 9A, 9B, 214

BNC Connectors MIL-C-39012 — 50 Ohm

Product Facts

- Dual "O" Crimp Connectors are MIL-C-39012, Class II, Category A or B qualified
- Bayonet lock coupling for quick connect/disconnect
- Various connectors available in 50 ohm versions
- Fully intermateable with comparable BNC UG/U connectors
- Low VSWR

Related Product Data

Performance Specifications — See chart below

Material Specifications — See chart below

Military Category — All MIL type "O" crimp connectors are Category B Type (AMP Crimp Tooling), unless otherwise noted.

Packaging — All connectors are packaged individually.

The AMP BNC RF MIL-C-39012 connector family with bayonet locking coupling provides highly reliable, quick connect/disconnect coaxial connections. Exclusive "O" crimp terminations allow positive insulation grip and require no soldering, providing terminations at a very low overall applied cost.

Available in 50 ohm versions, these connectors feature numerous styles including cable plugs and jacks. These connectors accept a wide range of coaxial cables and are intermateable with industry standard connectors designed to MIL-C-39012 specifications.



Characteristics	Category B "O" Crimp (MIL Type)
Electrical	
Impedance, Nom. (Ohms)	50
Working Voltage (Volts RMS)	500
Contact Resistance (Milliohms)	Inner: 1.5 Outer: 2.0
Initial Insulation Resistance (Megohms)	5000
Dielectric Withstanding Voltage (VAC)	1500
Corona Level at 70,000 ft. (Volts, RMS)	375
RF Leakage, Max. (dB)	-55 at 2-3 GHz
RF Insertion Loss, Max. (dB)	0.2 at 3 GHz
Frequency Range (GHz)	0-4
VSWR in Frequency Range Max.	1.30
Mechanical	
Force to Engage (lbs. [N])/couple, (in-lbs. [N-M]) max.	13.3/11.12 [3/2.5]
Coupling Nut Retention, Min. N [lbs.]	444.8 [100]
Cable Retention, N [lbs.]	266.9 [60] (RG58C/U)
Durability (Cycles)	500
Jam Nut Mounting Torque, Max. [N•m] (in. lbs.)	25 [2.8]
Environmental	
Temperature Range, Operating (C°)	-65 to +165 ¹ / -55 to +85 ²
Vibration	MIL-STD-202 Method 204 Cond. B
Physical Shock	MIL-STD-202 Method 213 Cond. G, 50 G's
Thermal Shock	MIL-STD-202 Method 107
Moisture Resistance	MIL-STD-202 Method 106
Salt Spray	MIL-STD-202 Method 101 Cond. B
Product Specification	108-12020

¹ Assembled to cable with polytetrafluoroethylene dielectric.

² Assembled to cable with polyethylene dielectric.

Connector Component	Category A & B "O" Crimp (MIL Type)
Connector Material	
Collar	Brass, QQ-B-626
Outer Contact (Plug)	Phos. Bronze, QQ-B-750
Shell (Jack)	Brass, QQ-B-626
Dielectric	TEFLON, MIL-P-19468
Center Contact (Plug)	Brass, QQ-B-626
Center Contact (Jack)	Beryl. Copper, ASTM-B-643 QQ-C-530
Gasket	Silicon Rubber, QQ-R-765
Ferrule	Copper, QQ-C-576
Connector Primary Finishes¹	
Collar	Silver, QQ-S-365 Bright Nickel, QQ-N-290
Outer Contacts (Plug & Jack)	Silver, QQ-S-365 Bright Nickel, QQ-N-290
Center Contacts (Plug & Jack)	Gold MIL-G-45204
Ferrule ²	Silver, QQ-S-365 Tin Lead, ASTM-B-545

¹ If more than one finish is listed, refer to individual catalog page(s) or customer drawings for exact specification.

² Ferrules with tin-lead finish are used with nickel plated outer contacts.

BNC Connectors MIL-C-39012 — 50 Ohm (Continued)

Dual Crimp Plugs
MIL-C-39012/16

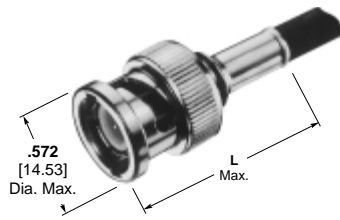

Military Part No.	AMP Part No.	Dim L	Category	RG/U Cable	Interchangeable Dies For PRO-CRIMPER Hand Tool 354940-1 or PRO-CRIMPER Adapter 679304-1	Interchangeable Dies for Hand Tool 69710-1 & 626 Pneu. Head 318161-1
B0004	2-331350-1	1.328 33.74	B	58,58A,58B,58C	220189-3 or 91901-1	69727
B0007	2-331350-9	1.188 30.18	B	142,142A,142B,400	220189-3 or 91901-1	69727
B0008	331350	1.188 30.18	B	124, 140, 210, 62, 62A, 62B, 59, 59A, 59B Belden 9291, 9209, 9269	58537-1	69669-1

Dual Crimp Jacks
MIL-C-39012/17

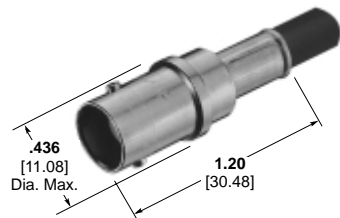

Military Part No.	AMP Part No.	Category	RG/U Cable	Interchangeable Dies For PRO-CRIMPER Hand Tool 354940-1 or PRO-CRIMPER Adapter 679304-1	Interchangeable Dies for Hand Tool 69710-1 & 626 Pneu. Head 318161-1
B0004	2-331351-1	B	58, 58A, 58B, 58C	220189-3 or 91901-1	69727
B0008	331351	B	124, 140, 210, 62, 62A, 62B, 59, 59A, 59B Belden 9291, 9209, 9269	58537-1	69669-1

Dual Crimp Bulkhead Jacks
MIL-C-39012/19

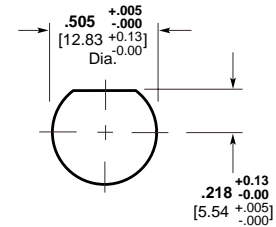
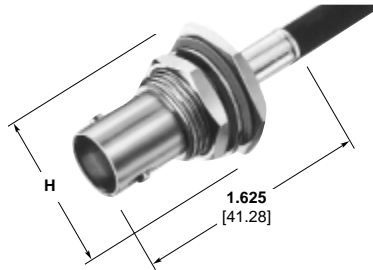

H = 11/16" across flats, .800 [20.32] Max. across points

Recommended Panel Cutout
Maximum Panel Thickness .125 [3.18]

Military Part No.	AMP Part No.	Category	RG/U Cable	Interchangeable Dies For PRO-CRIMPER Hand Tool 354940-1 or PRO-CRIMPER Adapter 679304-1	Interchangeable Dies for Hand Tool 69710-1 & 626 Pneu. Head 318161-1
B0003	1-331693-1	B	58, 58A, 58B, 58C	220189-3 or 91901-1	69727
B0007	331693	B	124, 140, 210, 62, 62A, 62B, 59, 59A, 59B Belden 9291, 9209, 9269	58537-1	69669-1

Field Serviceable Bulkhead Jack
MIL-C-39012/19

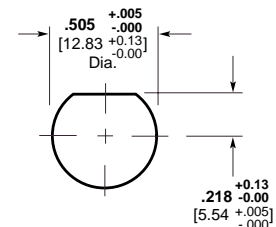
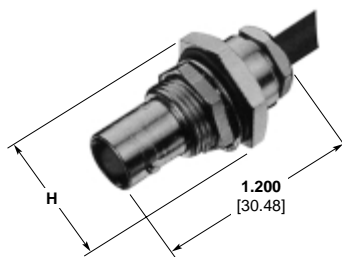

H = 11/16" across flats, .800 [20.32] Max. across points

Recommended Panel Cutout
Maximum Panel Thickness .240 [6.10]

Military Part No.	AMP Part No.	Category	RG/U Cable
-0102	221313-2	A	124, 140, 210, 62, 62A, 62B, 59, 59A, 59B, Belden 9291, 9209, 9269, 89269, 88241, Hi-Temp 62A, Times PL-62, Berk-Tek BTDC-59, BTDC-62, 302, 71, 71A, 71B

TNC Connectors MIL-C-39012 — 50 Ohm

Product Facts

- Dual "O" Crimp Connectors are MIL-C-39012, Class II, Category B qualified
- 50 ohm versions available
- Provides excellent performance at frequencies up to 11 GHz
- Standard and weatherproof versions available
- Plugs available for high temperature cable

The AMP TNC RF MIL-C-39012 connector family, with 7/16-28 threaded couplings, provides low noise levels and optimum stability, and can withstand the shock and vibration often present in harsh environments.

Available in 50 ohm versions, these connectors feature cable plugs and jacks. These connectors accept a wide range of coaxial cables and are interchangeable with industry standard connectors designed to MIL-C-39012 specifications.



Related Product Data

Military Category — All crimp connectors are Category B Type (AMP Crimp Tooling), unless otherwise noted.

Packaging — All connectors are packaged individually.

Characteristics	Category B "O" Crimp (MIL Type)
Electrical	
Impedance, Nom. (Ohms)	50
Working Voltage (Volts RMS)	500
Contact Resistance (Milliohms)	Inner: 1.5 Outer: 0.2
Initial Insulation Resistance (Megohms)	5000
Dielectric Withstanding Voltage (VAC)	1500
Corona Level at 70,000 ft. (Picocoulombs)	5 max. @375 VRMS
RF Leakage, Max. (dB)	60 at 2-3 GHz
RF Insertion Loss, Max. (dB)	0.18 at 9 GHz
Frequency Range (GHz)	0-11
VSWR in Frequency Range Max.	1.3
Mechanical	
Force to Engage/Couple, lbs. [N]	2/2 [8.9/8.9]
Coupling Nut Retention, Min. lbs. [N]	100 [444.8]
Cable Retention, lbs. [N]	60 [266.9] RG58C/U
Durability (Cycles)	500
Jam Nut Mounting Torque, Max. lbs. [N•m]	25 [2.8]
Environmental	
Temperature Range, Operating (C°)	-65 to +165 ¹ / -55 to +85 ²
Vibration	MIL-STD-202 Method 204 Cond. B
Physical Shock	MIL-STD-202 Method 213 Cond. I, (100 G's)
Thermal Shock	MIL-STD-202 Method 107 Cond. B
Moisture Resistance	MIL-STD-202 Method 106
Salt Spray	MIL-STD-202 Method 101 Cond. B
Product Specification	108-12001

¹ Assembled to cable with polytetrafluoroethylene dielectric.

² Assembled to cable with polyethylene dielectric.

Characteristics	Category B "O" Crimp (MIL Type)
Connector Material	
Collar	Brass, QQ-B-626
Outer Contact (Plug)	Phos. Bronze, QQ-B-750 Beryl. Copper, QQ-C-530
Outer Contact (Jack)	Brass, QQ-B-626
Dielectric	TEFLON, MIL-P-19468
Center Contact (Plug)	Brass, QQ-B-626
Center Contact (Jack)	Beryl. Copper, ASTM-B-643 QQ-C-530
Gasket	Silicon Rubber, QQ-R-765
Ferrule	Copper, QQ-C-576
Connector Primary Finishes¹	
Collar	Silver, QQ-S-365
Outer Contact (Plug & Jack)	Bright Nickel, QQ-N-290
Center Contact (Plug & Jack)	Silver, QQ-S-365
Ferrule	Gold, MIL-G-45204

¹ If several finishes are listed, refer to individual catalog page(s) or customer drawings for exact specification.

Dual Crimp Plugs MIL-C-39012/26 (Weatherproof)

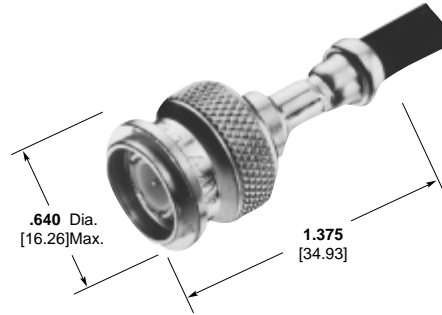

Military Part No.	AMP Part No.	RG/U Cable	Interchangeable Dies for PRO-CRIMPER Frame 354940-1
B0005	225550-2	58, 58A, 58B, 58C	91902-1
B0006	225550-6	142, 142A, 142B, 400	91902-1
B0007	225550-3	124, 140, 210, 62, 62A, 62B, 59, 59A, 59B, Belden 9291, 9209, 9269	91903-1
B0016	225550-1	55, 55A, 55B, 223	91902-1

Crimp Jacks MIL-C-39012/27 (Weatherproof)



Military Part No.	AMP Part No.	RG/U Cable	Interchangeable Dies for PRO-CRIMPER Frame 354940-1
B0005	225551-2	58, 58A, 58B, 58C	91902-1
B0015	225551-5	141, 141A, 303	91902-1
B0016	225551-1	55, 55A, 55B, 223	91902-1
B0006	225551-6	142, 142A, 142B, 400	91902-1

Crimp Panel Jack MIL-C-39012/29

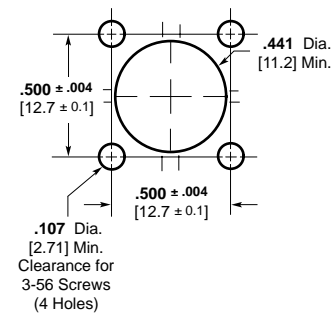
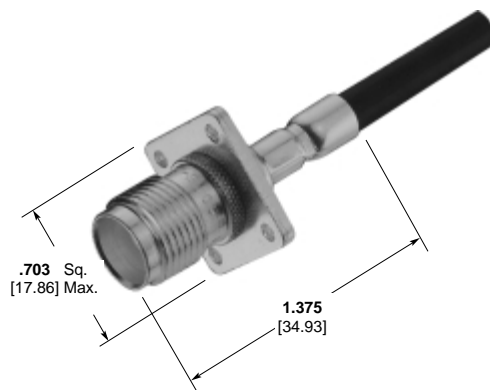

Recommended Panel Cutout

Military Part No.	AMP Part No.	RG/U Cable	CERTI-CRIMP Hand Tool with Integral Die
B0005	225348-2	58, 58A, 58B, 58C	220045-2

Product Facts

- Performance to 18 GHz
- Uses industry standard crimp tools and processes
- Qualified to MIL-C-39012

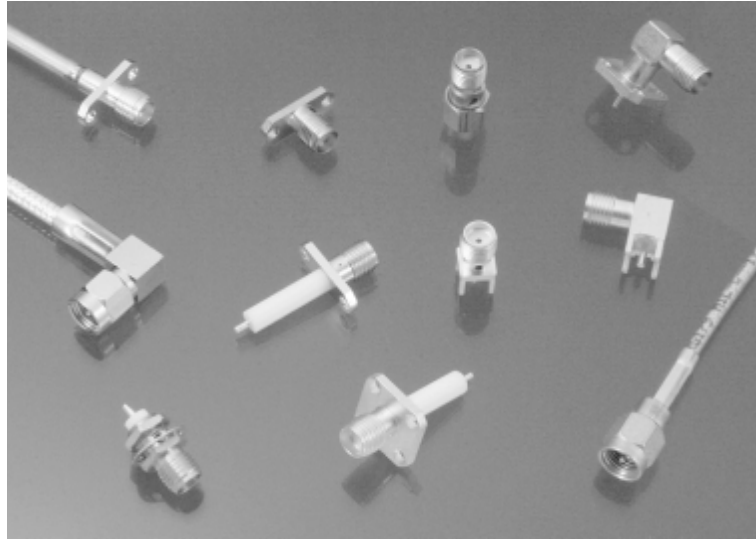

Tyco Electronics offers a complete line of SMA connectors. To satisfy the broad range of applications, SMA connectors are available in a broad range of standard configurations including: straight and right-angle cable applied plugs,

bulkhead cable jacks, two and four hole flange mount panel jacks, straight and right-angle pcb mount jacks and various between and in-series adapters, including connectors for semi-rigid cable and micro-strip applications.

Electrical Properties

MIL Type	Cable Military Slash Sheet M17/	Frequency Max. (GHz)	VSWR (fGHz)	Contact Resistance (milliohms max.)		Insulation Resistance (megohms min.)	Dielectric Withstanding Voltage (Volts RMS)	Corona Extinction Voltage at 70,000 Ft. (V RMS min.)	RF Transmission Loss (GHz)	RF High Potential at 5 MHz (V RMS)	RF Leakage (dB min.)
				Center Contact	Outer Contact						
MIL-C-39012/55	93-RG178	12.4	1.20+0.025	3	2	5,000	500	125	0.06 x sqrt (freq)	335	-60
	54-RG122, 119-RG174, 94-RG179, 113-RG316, 152-	12.4	1.15+0.02	3	2	5,000	750	190	0.06 x sqrt (freq)	500	-60
	28-RG058, 60-RG142, 84-RG223, 111-RG303, 128-RG400	12.4	1.15+0.01	3	2	5,000	1000	250	0.06 x sqrt (freq)	670	-60
	169-00001	12.4	1.15+0.01	3	2	5,000	500	125	0.06 x sqrt (freq)	335	-60
	173-00001, 172-00001, 157-00001	12.4	1.15+0.01	3	2	5,000	750	190	0.06 x sqrt (freq)	500	-60
	155-0001, 158-00001, 167-00001, 170-00001, 175-00001	12.4	1.15+0.01	3	2	5,000	1000	250	0.06 x sqrt (freq)	670	-60
MIL-C-39012/56	93-RG178	12.4	1.20+0.03	4	2	5,000	500	125	0.15 x sqrt (freq)	335	-60
	54-RG122, 119-RG174, 94-RG179, 113-RG316, 152-00001	12.4	1.15+0.03	4	2	5,000	750	190	0.15 x sqrt (freq)	500	-60
	28-RG058, 60-RG142, 84-RG223, 111-RG303, 128-RG400	12.4	1.15+0.02	4	2	5,000	1000	250	0.15 x sqrt (freq)	670	-60
	169-00001	12.4	1.15+0.02	4	2	5,000	500	125	0.15 x sqrt (freq)	335	-60
	173-00001, 172-00001, 157-00001	12.4	1.15+0.02	4	2	5,000	750	190	0.15 x sqrt (freq)	500	-60
	155-0001, 158-00001, 167-00001, 170-00001, 175-00001	12.4	1.15+0.02	4	2	5,000	1000	250	0.15 x sqrt (freq)	670	-60
MIL-C-39012/57, /58 & /59	93-RG178	12.4	1.20+0.025	3	2	5,000	500	125	0.06 x sqrt (freq)	335	-60
	54-RG122, 119-RG174, 113-RG316	12.4	1.15+0.02	3	2	5,000	750	190	0.06 x sqrt (freq)	500	-60
	28-RG058, 60-RG142, 84-RG223, 111-RG303, 128-RG400	12.4	1.15+0.01	3	2	5,000	1000	250	0.06 x sqrt (freq)	670	-60
	169-00001	12.4	1.15+0.01	3	2	5,000	500	125	0.06 x sqrt (freq)	335	-60
	173-00001, 172-00001, 157-00001	12.4	1.15+0.01	3	2	5,000	750	190	0.06 x sqrt (freq)	500	-60
	155-0001, 158-00001, 167-00001, 170-00001, 175-00001	12.4	1.15+0.01	3	2	5,000	1000	250	0.06 x sqrt (freq)	670	-60
MIL-C-39012/60, & /61	—	N/A	N/A	3	2	5,000	1000	250	N/A	670	N/A
MIL-C-39012/79	133-RG405, 133-00001 Thru 133-00011 Captive	18	1.07+0.01	3	2	5,000	1000	250	0.03 x sqrt (freq)	670	-90
	130-RG402, 130-00001 Thru 133-00007 Captive	18	1.05+0.01	3	2	5,000	1500	375	0.03 x sqrt (freq)	1000	-90
	133-RG405, 133-00001 Thru 133-00011 Non-Captive	18	1.07+0.008	3	2	5,000	1000	250	0.03 x sqrt (freq)	670	-90
	130-RG402, 130-00001 Thru 130-00007 Non-Captive	18	1.05+0.008	3	2	5,000	1500	375	0.03 x sqrt (freq)	1000	-90
MIL-C-39012/80	133-RG405, 133-00001 Thru 133-00011	18	1.10+0.01	4	2	5,000	1000	250	0.05 x sqrt (freq)	670	-90
	130-RG402, 130-00001 Thru 130-00007	18	1.10+0.01	4	2	5,000	1500	375	0.05 x sqrt (freq)	1000	-90
MIL-C-39012/81, /82 & /83	133-RG405, 133-00001 Thru 133-00011 Captive	18	1.07+0.01	3	2	5,000	1000	250	0.03 x sqrt (freq)	670	-90
	130-RG402, 130-00001 Thru 133-00007 Captive	18	1.05+0.01	3	2	5,000	1500	375	0.03 x sqrt (freq)	1000	-90
	133-RG405, 133-00001 Thru 133-00011 Non-Captive	18	1.07+0.008	3	2	5,000	1000	250	0.03 x sqrt (freq)	670	-90
	130-RG402, 130-00001 Thru 130-00007 Non-Captive	18	1.05+0.008	3	2	5,000	1500	375	0.03 x sqrt (freq)	1000	-90
MIL-C-39012/92	—	18	1.035+0.005	N/A	2	5,000	N/A	250	0.03 x sqrt (freq)	670	-90
MIL-C-39012/93 & /94	—	18	N/A	3	2	5,000	1000	250	N/A	670	N/A

Mechanical and Environmental Properties

MIL Type	Force to Engage (in-lbs)	Coupling Nut Retention (lbs.)	Coupling Proof Torque (in-lbs)	Cable Retention			Insertion	Withdrawal	Connector Durability	Recommended Mating Torque (in lbs.)
				Dia.	Lbs. Min.	In.-Ounces				
MIL-C-39012/55	2 max.	60	15 min.	0.036 [0.91] 0.067 [1.70] 0.110 [2.79] 0.122 [3.10]	10 20 30 40	N/A	N/A	N/A	500 cycles min.	7-10
MIL-C-39012/56	2 max.	60	15 min.	0.036 [0.91] 0.067 [1.70] 0.110 [2.79] 0.122 [3.10]	10 20 30 40	N/A	N/A	N/A	500 cycles min.	7-10
MIL-C-39012/57, /58 & /59	2 max.	N/A	N/A	0.036 [0.91] 0.067 [1.70] 0.110 [2.79] 0.122 [3.10]	10 20 30 40	N/A	2 lbs. max. w/ .0370 dia. pin	1 oz. min. w/ .0355 dia. pin	500 cycles min.	7-10
MIL-C-39012/60, & /61	2 max.	N/A	N/A	N/A	N/A	N/A	2 lbs. max. w/ .0370 dia. pin	1 oz. min. w/ .0355 dia. pin	500 cycles min.	7-10
MIL-C-39012/79	2 max.	60	15 min.	133-RG405, 133-00001 Thru 133-00011 130-RG402, 130-00001 Thru 130-00007	30 60	16 55	N/A	N/A	500 cycles min.	7-10
MIL-C-39012/80	2 max.	60	15 min.	133-RG405, 133-00001 Thru 133-00011 130-RG402, 130-00001 Thru 130-00007	30 60	16 55	N/A	N/A	500 cycles min.	7-10
MIL-C-39012/81, /82 & /83	2 max.	N/A	N/A	133-RG405, 133-00001 Thru 133-00011 130-RG402, 130-00001 Thru 130-00007	30 60	16 55	2 lbs. max. w/ .0370 dia. pin	1 oz. min. w/ .0355 dia. pin	500 cycles min.	7-10
MIL-C-39012/92	2 max.	60	15 min.	N/A	N/A	N/A	N/A	N/A	100 cycles min.	7-10
MIL-C-39012/93 & /94	2 max.	N/A	N/A	N/A	N/A	N/A	2 lbs. max. w/ .0370 dia. pin	1 oz. min. w/ .0355 dia. pin	500 cycles min.	7-10

Environmental

MIL Type	Vibration	Shock	Thermal Shock	Corrosion (Salt Spray)	Moisture Resistance
MIL-C-39012/55	MIL-STD-202 Method 204 Cond. D No Discontinuity	MIL-STD-202 Method 213 Cond. 1 No Discontinuity	MIL-STD-202 Method 107 Cond. B Except T _H 85C	MIL-STD-202 Method 101 Cond. B	MIL-STD-202, Method 106 No Measurement @ High Humidity Insulation Resistance 200 Megaohms with 5 min. of removal from humidity
MIL-C-39012/56	MIL-STD-202 Method 204 Cond. D No Discontinuity	MIL-STD-202 Method 213 Cond. 1 No Discontinuity	MIL-STD-202 Method 107 Cond. B Except T _H 85C	MIL-STD-202 Method 101 Cond. B	MIL-STD-202, Method 106 No Measurement @ High Humidity Insulation Resistance 200 Megaohms with 5 min. of removal from humidity
MIL-C-39012/57, /58 & /59	MIL-STD-202 Method 204 Cond. D No Discontinuity	MIL-STD-202 Method 213 Cond. 1 No Discontinuity	MIL-STD-202 Method 107 Cond. B Except T _H 85C	MIL-STD-202 Method 101 Cond. B	MIL-STD-202, Method 106 No Measurement @ High Humidity Insulation Resistance 200 Megaohms with 5 min. of removal from humidity
MIL-C-39012/60, & /61	MIL-STD-1344 Method 2005 Cond. IV No Discontinuity	MIL-STD-1344 Method 2004 Cond. G No Discontinuity	MIL-STD-1344 Method 1003 Cond. A Except T _H 200C	MIL-STD-1344 Method 1001 Cond. B	MIL-STD-1344, Method 1002, Type II No Measurement @ High Humidity Insulation Resistance 200 Megaohms with 5 min. of removal from humidity
MIL-C-39012/79	MIL-STD-202 Method 204 Cond. D No Discontinuity	MIL-STD-202 Method 213 Cond. 1 No Discontinuity	MIL-STD-202 Method 107 Cond. B Except T _H 115C	MIL-STD-202 Method 101 Cond. B	MIL-STD-202, Method 106 No Measurement @ High Humidity Insulation Resistance 200 Megaohms with 5 min. of removal from humidity
MIL-C-39012/80	MIL-STD-202 Method 204 Cond. D No Discontinuity	MIL-STD-202 Method 213 Cond. 1 No Discontinuity	MIL-STD-202 Method 107 Cond. B Except T _H 115C	MIL-STD-202 Method 101 Cond. B	MIL-STD-202, Method 106 No Measurement @ High Humidity Insulation Resistance 200 Megaohms with 5 min. of removal from humidity
MIL-C-39012/81, /82 & /83	MIL-STD-202 Method 204 Cond. D No Discontinuity	MIL-STD-202 Method 213 Cond. 1 No Discontinuity	MIL-STD-202 Method 107 Cond. B Except T _H 115C	MIL-STD-202 Method 101 Cond. B	MIL-STD-202, Method 106 No Measurement @ High Humidity Insulation Resistance 200 Megaohms with 5 min. of removal from humidity
MIL-C-39012/92	MIL-STD-202 Method 204 Cond. D No Discontinuity	MIL-STD-202 Method 213 Cond. 1 No Discontinuity	MIL-STD-202 Method 107 Cond. B Except T _H 115C	MIL-STD-202 Method 101 Cond. B	MIL-STD-202, Method 106 No Measurement @ High Humidity Insulation Resistance 200 Megaohms with 5 min. of removal from humidity
MIL-C-39012/93 & /94	MIL-STD-202 Method 204 Cond. D No Discontinuity	MIL-STD-202 Method 213 Cond. 1 No Discontinuity	MIL-STD-202 Method 107 Cond. B Except T _H 125C	MIL-STD-202 Method 101 Cond. B	MIL-STD-202, Method 106 No Measurement @ High Humidity Insulation Resistance 200 Megaohms with 5 min. of removal from humidity

MIL-C-39012/55

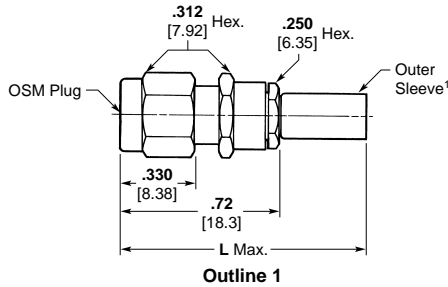

Outline 1

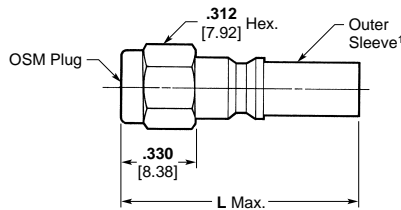

Outline 2

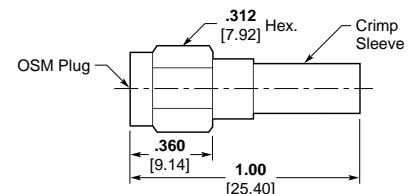

Outline 3

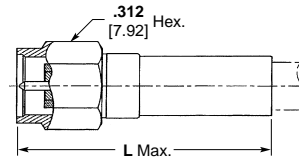

Outline 4

Military Part No.	AMP Part No.	M/A-COM ⁶ Part No. (Ref. Only)	Outline	Cat. ¹	RG/U Cable	Dim. L
-3006	1051757-1	2031-8006-92	1	A	178	1.030 [26.16]
-3007	1051759-1	2031-8007-92	1	A	174, 316	1.030 [26.16]
-3008	1051760-1	2031-8008-92	2	A	122	1.030 [26.16]
-3009	1051762-1	2031-8009-92	2	A	58, 142, 223	1.030 [26.16]
-3010	1051763-1	2031-8010-92	2	A	303	1.030 [26.16]
B3011	1051764-1	2031-8011-92	1	B	178	1.250 [31.75]
B3012	1051766-1	2031-8012-92	2	B	174, 316	1.250 [31.75]
B3013	1051767-1	2031-8013-92	2	B	122	1.250 [31.75]
B3014	1051768-1	2031-8014-92	2	B	58	1.250 [31.75]
B3015	1051769-1	2031-8015-92	2	B	142	1.250 [31.75]
B3016	1051770-1	2031-8016-92	2	B	223	1.250 [31.75]
B3017	1484541-1	2031-8017-92	2	B	303	1.250 [31.75]
B3018	1051771-1	2031-8018-92	1	B	178	1.375 [34.93]
B3019	1056413-1	2031-8019-92	1	B	174, 316	1.375 [34.93]
B3019	225532-4 ²	—	4	B	174, 188, 188A, 316	.950 [24.13]
B3020	1051774-1	2031-8020-92	2	B	122	1.375 [34.93]
B3021	1051775-1	2031-8021-92	2	B	58	1.375 [34.93]
B3021	225532-1 ²	—	4	B	58, 58A, 58B, 58C	1.030 [26.16]
B3022	1051776-1	2031-8022-92	2	B	142	1.375 [34.93]
B3022	225532-3 ²	—	4	B	142, 142A, 142B, 400, Belden 84142	1.030 [26.16]
B3023	1051777-1	2031-8023-92	2	B	223	1.375 [34.93]
B3023	1-225532-0 ²	—	4	B	223, 55, 55A, 55B	1.030 [26.16]
B3024	1051778-1	2031-8024-92	2	B	303	1.375 [34.93]
B3024	225532-9 ²	—	4	B	141, 141A, 303	1.030 [26.16]
-3025	1051780-1	2031-8025-92	1	C	178	1.250 [31.75]
-3026	1051782-1	2031-8026-92	1	C	174, 316	1.250 [31.75]
-3027	1051783-1	2031-8027-92	2	C	122	1.250 [31.75]
-3028	1051785-1	2031-8028-92	2	C	142, 223	1.250 [31.75]
-3029	1051787-1	2031-8029-92	2	C	58, 303	1.250 [31.75]
*-3106	1051789-1	2031-8106-92	1	A	178	1.030 [26.16]

Military Part No.	AMP Part No.	M/A-COM ⁶ Part No. (Ref. Only)	Outline	Cat. ¹	RG/U Cable	Dim. L
*-3107	1051791-1	2031-8107-92	1	A	174, 316	1.030 [26.16]
*-3108	1051792-1	2031-8108-92	2	A	122	1.030 [26.16]
*-3109	1051794-1	2031-8109-92	2	A	58, 142, 223	1.030 [26.16]
*-3110	1051795-1	2031-8110-92	2	A	303	1.030 [26.16]
*B3111	1051796-1	2031-8111-92	1	B	178	1.250 [31.75]
*B3112	1051797-1	2031-8112-92	2	B	174, 316	1.250 [31.75]
*B3113	1051798-1	2031-8113-92	2	B	122	1.250 [31.75]
*B3114	1051799-1	2031-8114-92	2	B	58	1.250 [31.75]
*B3115	1051800-1	2031-8115-92	2	B	142	1.250 [31.75]
*B3116	1051801-1	2031-8116-92	2	B	223	1.250 [31.75]
*B3117	1051802-1	2031-8117-92	2	B	303	1.250 [31.75]
*B3118	1051803-1	2031-8118-92	1	B	178	1.375 [34.93]
*B3119	1051804-1	2031-8119-92	1	B	174, 316	1.375 [34.93]
*B3120	1051805-1	2031-8120-92	2	B	122	1.375 [34.93]
*B3121	1051806-1	2031-8121-92	2	B	58	1.375 [34.93]
*B3122	1051807-1	2031-8122-92	2	B	142	1.375 [34.93]
*B3123	1051808-1	2031-8123-92	2	B	223	1.375 [34.93]
*B3124	1051809-1	2031-8124-92	2	B	303	1.375 [34.93]
*-3125	1051810-1	2031-8125-92	1	C	178	1.250 [31.75]
*-3126	1051812-1	2031-8126-92	1	C	174, 316	1.250 [31.75]
*-3127	1051813-1	2031-8127-92	2	C	122	1.250 [31.75]
*-3128	1051815-1	2031-8128-92	2	C	142, 223	1.250 [31.75]
*-3129	1051816-1	2031-8129-92	2	C	58, 303	1.250 [31.75]
-3502	1051788-1	2031-8052-92	2	D	142, 400	1.250 [31.75]
*-3602	1051817-1	2031-8162-92	2	D	142, 400	1.250 [31.75]
-4026	1532129-5 ³	—	3	C	174, 316	—
*-4126	1532129-6 ³	—	3	C	174, 316	—
-4027	1532129-7 ⁴	—	3	C	122	—
*-4127	1532129-8 ⁴	—	3	C	122	—
-4028	1532129-9 ⁵	—	3	C	142, 223	—
*-4128	1-1532129-0 ⁵	—	3	C	142, 223	—
-4029	1-1532129-1 ⁵	—	3	C	58, 303	—
*-4129	1-1532129-2 ⁵	—	3	C	58, 303	—

* No safety wire holes.

¹ Category A: solder sleeve; Categories B, C and D: crimp sleeve.

² Use Integral Die Crimp Tool Part Number 220061-1.

³ Crimp Tool M22520/5-01 and M22520/5-35 Closure B. Alternate Crimp Tool M22520/10-01 and M22520/10-13.

⁴ Crimp Tool M22520/5-01 and M22520/5-41 Closure B. Alternate Crimp Tool M22520/10-01 and M22520/10-17.

⁵ Crimp Tool M22520/5-01 and M22520/5-19 Closure B. Alternate Crimp Tool M22520/10-01 and M22520/10-21.

⁶ -92 indicates passivated stainless steel finish.

See page 7003 for description of categories and pages 7059-7064 for tooling (unless noted otherwise).

MIL-C-39012/56

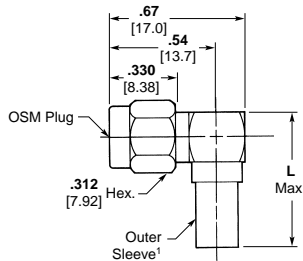

Outline 1

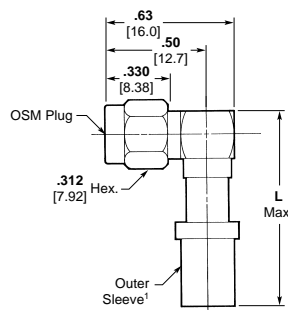

Outline 2

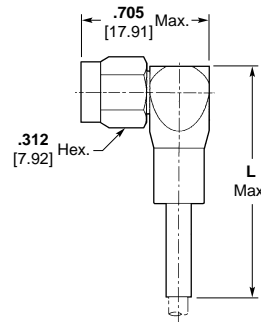

Outline 3

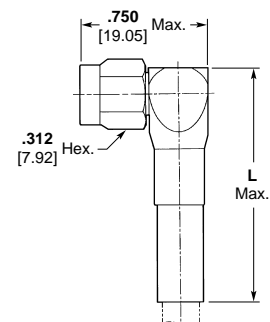

Outline 4

Military Part No.	AMP Part No.	M/A-COM [®] Part No. (Ref. Only)	Outline	Cat. ¹	RG/U Cable	Dim. L
-3006	1052149-1	2037-8006-92	1	A	178	1.125 [28.58]
-3007	1052151-1	2037-8007-92	1	A	174, 316	1.125 [28.58]
-3008	1052152-1	2037-8008-92	1	A	122	1.125 [28.58]
-3009	1052154-1	2037-8009-92	1	A	58, 142, 223	1.125 [28.58]
-3010	1052155-1	2037-8010-92	1	A	303	1.125 [28.58]
B3011	1052156-1	2037-8011-92	1	B	178	1.250 [31.75]
B3012	1052157-1	2037-8012-92	1	B	174, 316	1.250 [31.75]
B3013	1052158-1	2037-8013-92	1	B	122	1.250 [31.75]
B3014	1052159-1	2037-8014-92	1	B	58	1.250 [31.75]
B3015	1052160-1	2037-8015-92	1	B	142	1.250 [31.75]
B3016	1052161-1	2037-8016-92	1	B	223	1.250 [31.75]
B3017	1052162-1	2037-8017-92	1	B	303	1.250 [31.75]
B3018	1052163-1	2037-8018-92	1	B	178	1.375 [34.93]
B3019	1052165-1	2037-8019-92	1	B	174, 316	1.375 [34.93]
B3019	225609-4 ²	—	3	B	174, 188, 188A, 316	1.187 [30.15]
B3020	1052166-1	2037-8020-92	1	B	122	1.375 [34.93]
B3021	1052167-1	2037-8021-92	1	B	58	1.375 [34.93]
B3021	225609-1 ²	—	4	B	58, 58A, 58B, 58C	1.250 [31.75]
B3022	1052168-1	2037-8022-92	1	B	142	1.375 [34.93]
B3022	225609-3 ²	—	4	B	142, 142A, 142B, 400, Belden 84142	1.250 [31.75]
B3023	1052169-1	2037-8023-92	1	B	223	1.375 [34.93]
B3024	1052170-1	2037-8024-92	1	B	303	1.375 [34.93]
-3025	1052171-1	2037-8025-92	1	C	178	1.375 [34.93]
-3026	1052173-1	2037-8026-92	1	C	174, 316	1.375 [34.93]
-3027	1052174-1	2037-8027-92	1	C	122	1.375 [34.93]
-3028	1052176-1	2037-8028-92	1	C	142, 223	1.375 [34.93]

* No safety wire holes.

¹ Category A: solder sleeve; Categories B, C and D: crimp sleeve.

² Use Integral Crimp Tool Part Number 220061-1.

³ -92 indicates passivated stainless steel finish.

See page 7003 for description of categories and pages 7059-7064 for tooling (unless noted otherwise).

Military Part No.	AMP Part No.	M/A-COM [®] Part No. (Ref. Only)	Outline	Cat. ¹	RG/U Cable	Dim. L
-3029	1052177-1	2037-8029-92	1	C	58, 303	1.375 [34.93]
*-3106	1052179-1	2037-8106-92	1	A	178	1.125 [28.58]
*-3107	1052181-1	2037-8107-92	1	A	174, 316	1.125 [28.58]
*-3108	1052182-1	2037-8108-92	1	A	122	1.125 [28.58]
*-3109	1052184-1	2037-8109-92	1	A	58, 142, 223	1.125 [28.58]
*-3110	1052185-1	2037-8110-92	1	A	303	1.125 [28.58]
*B3111	1052186-1	2037-8111-92	1	B	178	1.250 [31.75]
*B3112	1052187-1	2037-8112-92	1	B	174, 316	1.250 [31.75]
*B3113	1052188-1	2037-8113-92	1	B	122	1.250 [31.75]
*B3114	1052189-1	2037-8114-92	1	B	58	1.250 [31.75]
*B3115	1052190-1	2037-8115-92	1	B	142	1.250 [31.75]
*B3116	1052191-1	2037-8116-92	1	B	223	1.250 [31.75]
*B3117	1052192-1	2037-8117-92	1	B	303	1.250 [31.75]
*B3118	1052193-1	2037-8118-92	1	B	178	1.375 [34.93]
*B3119	1052194-1	2037-8119-92	1	B	174, 316	1.375 [34.93]
*B3120	1052195-1	2037-8120-92	1	B	122	1.375 [34.93]
*B3121	1052196-1	2037-8121-92	1	B	58	1.375 [34.93]
*B3122	1052197-1	2037-8122-92	1	B	142	1.375 [34.93]
*B3123	1052198-1	2037-8123-92	1	B	223	1.375 [34.93]
*B3124	1052199-1	2037-8124-92	1	B	303	1.375 [34.93]
*-3125	1052201-1	2037-8125-92	1	C	178	1.375 [34.93]
*-3126	1052203-1	2037-8126-92	1	C	174, 316	1.375 [34.93]
*-3127	1052204-1	2037-8127-92	1	C	122	1.375 [34.93]
*-3128	1052206-1	2037-8128-92	1	C	142, 223	1.375 [34.93]
*-3129	1052207-1	2037-8129-92	1	C	58, 303	1.375 [34.93]
-3502	1052178-1	2037-8052-92	2	D	142, 400	1.375 [34.93]
*-3602	1086723-1	2037-8162-92	2	D	142, 400	1.375 [34.93]

SMA Connectors MIL-C-39012 — For Flexible Cable (Continued)

MIL-C-39012/57

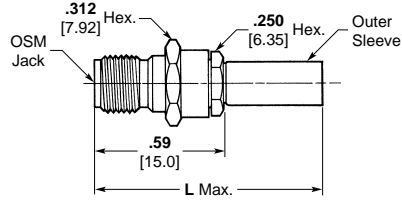

Outline 1

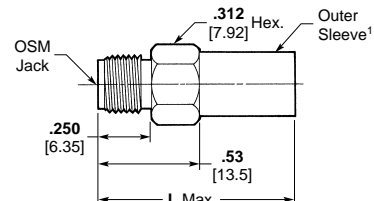

Outline 2

Military Part No.	AMP Part No.	M/A-COM ² Part No. (Ref. Only)	Outline	Cat. ¹	RG/U Cable	Dim. L
-3006	1090174-1	2032-8006-92	1	A	178	.960 [24.38]
-3007	1051900-1	2032-8007-92	1	A	174, 316	.960 [24.38]
-3008	1051901-1	2032-8008-90	2	A	122	.960 [24.38]
-3009	1051902-1	2032-8009-90	2	A	58, 142, 223	.960 [24.38]
-3010	1051903-1	2032-8010-90	2	A	303	.960 [24.38]
B3011	1051904-1	2032-8011-92	1	B	178	1.265 [32.13]
B3012	1051905-1	2032-8012-92	1	B	174, 316	1.265 [32.13]
B3013	1051906-1	2032-8013-92	2	B	122	1.265 [32.13]
B3014	1051907-1	2032-8014-92	2	B	58	1.265 [32.13]
B3015	1051908-1	2032-8015-92	2	B	142	1.265 [32.13]
B3016	1051909-1	2032-8016-92	2	B	223	1.265 [32.13]
B3017	1051910-1	2032-8017-92	2	B	303	1.265 [32.13]
B3018	1051911-1	2032-8018-92	1	B	178	1.265 [32.13]

Military Part No.	AMP Part No.	M/A-COM ² Part No. (Ref. Only)	Outline	Cat. ¹	RG/U Cable	Dim. L
B3019	1051912-1	2032-8019-92	1	B	174, 316	1.265 [32.13]
B3020	1051913-1	2032-8020-92	2	B	122	1.265 [32.13]
B3021	1051914-1	2032-8021-92	2	B	58	1.265 [32.13]
B3022	1051915-1	2032-8022-92	2	B	142	1.265 [32.13]
B3023	1051916-1	2032-8023-92	2	B	223	1.265 [32.13]
B3024	1051917-1	2032-8024-92	2	B	303	1.265 [32.13]
-3025	1051918-1	2032-8025-92	1	C	178	1.265 [32.13]
-3026	1051919-1	2032-8026-92	1	C	174, 316	1.265 [32.13]
-3027	1051920-1	2032-8027-92	2	C	122	1.265 [32.13]
-3028	1051921-1	2032-8028-92	2	C	142, 223	1.265 [32.13]
-3029	1051922-1	2032-8029-92	2	C	58, 303	1.265 [32.13]
-3502	1051923-1	2032-8052-92	2	D	142, 400	1.265 [32.13]

¹ Category A: solder sleeve; Categories B, C and D: crimp sleeve.
² -92 indicates passivated stainless steel finish.
 -90 indicates gold plated finish.
 See page 7003 for description of categories and pages 7059-7064 for tooling.

MIL-C-39012/58

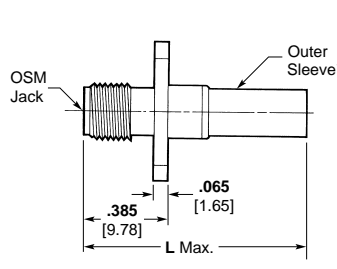
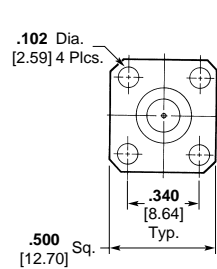

Outline 3

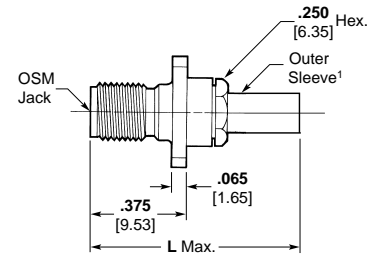

Outline 4

Military Part No.	AMP Part No.	M/A-COM ² Part No. (Ref. Only)	Outline	Cat. ¹	RG/U Cable	Dim. L
-3006	1052037-1	2036-8006-92	4	A	178	.960 [24.38]
-3007	1052038-1	2036-8007-92	4	A	174, 316	.960 [24.38]
-3008	1052039-1	2036-8008-90	3	A	122	.960 [24.38]
-3009	1052040-1	2036-8009-90	3	A	58, 142, 223	.960 [24.38]
-3010	1052041-1	2036-8010-90	3	A	303	.960 [24.38]
B3011	1052042-1	2036-8011-92	4	B	178	1.265 [32.13]
B3012	1254028-1	2036-8012-92	4	B	174, 316	1.265 [32.13]
B3013	1484499-1	2036-8013-92	3	B	122	1.265 [32.13]
B3014	1484500-1	2036-8014-92	3	B	58	1.265 [32.13]
B3015	1052043-1	2036-8015-92	3	B	142	1.265 [32.13]
B3016	1484501-1	2036-8016-92	3	B	223	1.265 [32.13]
B3017	1484502-1	2036-8017-92	3	B	303	1.265 [32.13]
B3018	1052044-1	2036-8018-92	4	B	178	1.265 [32.13]

Military Part No.	AMP Part No.	M/A-COM ² Part No. (Ref. Only)	Outline	Cat. ¹	RG/U Cable	Dim. L
B3019	1484503-1	2036-8019-92	4	B	174, 316	1.265 [32.13]
B3020	1484504-1	2036-8020-92	3	B	122	1.265 [32.13]
B3021	1484505-1	2036-8021-92	3	B	58	1.265 [32.13]
B3022	1052045-1	2036-8022-92	3	B	142	1.265 [32.13]
B3023	1484506-1	2036-8023-92	3	B	223	1.265 [32.13]
B3024	1484507-1	2036-8024-92	3	B	303	1.265 [32.13]
-3025	1052046-1	2036-8025-92	4	C	178	1.125 [28.58]
-3026	1052047-1	2036-8026-92	4	C	174, 316	1.125 [28.58]
-3027	1052048-1	2036-8027-92	3	C	122	1.125 [28.58]
-3028	1052049-1	2036-8028-92	3	C	142, 223	1.125 [28.58]
-3029	1052050-1	2036-8029-92	3	C	58, 303	1.125 [28.58]
-3502	1052051-1	2036-8052-92	3	D	142, 400	1.125 [28.58]

¹ Category A: solder sleeve; Categories B, C and D: crimp sleeve.
² -92 indicates passivated stainless steel finish.
 -90 indicates gold plated finish.
 See page 7003 for description of categories and pages 7059-7064 for tooling.

SMA Connectors MIL-C-39012 — Panel Mount

MIL-C-39012/60

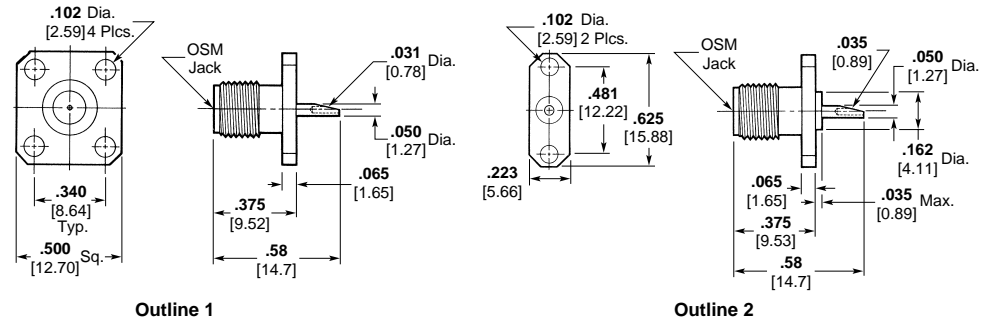

Military Part No.	AMP Part No.	M/A-COM ¹ Part No. (Ref. Only)	Outline
-3001	1052924-1	2052-8001-92	1
-3002	1052926-1	2052-8002-92	2

¹ -92 indicates passivated stainless steel finish.

MIL-C-39012/61

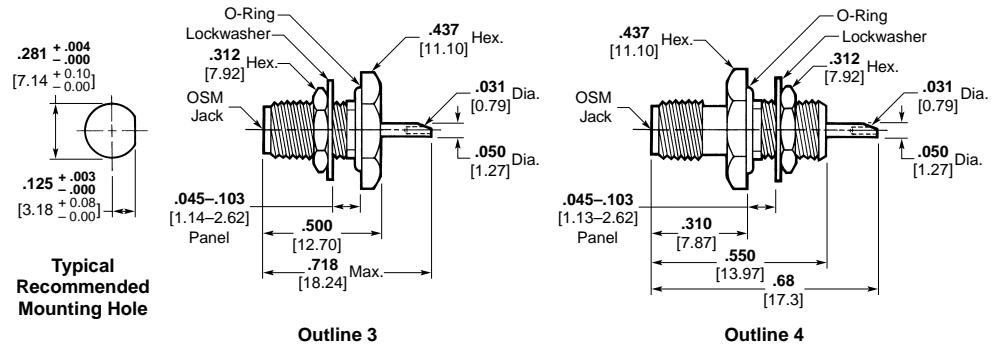

Military Part No.	AMP Part No.	M/A-COM ¹ Part No. (Ref. Only)	Outline
-3001	1053118-1	2056-8011-92	3
-3002	1484516-1	2058-8012-92	4

¹ -92 indicates passivated stainless steel finish.

MIL-C-39012/79

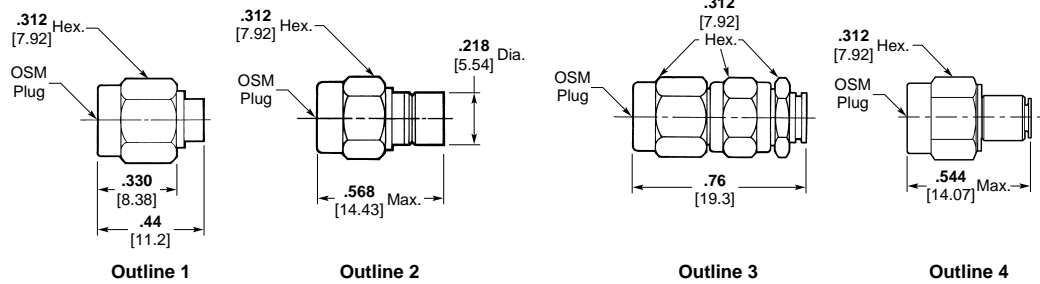

Military Part No.	AMP Part No.	M/A-COM ⁴ Part No. (Ref. Only)	Outline	Category	RG/U Cable
B3001	1050774-1	2001-8001-92	1	B	405
B3002	1050776-1	2001-8002-92	1	B	402
B3003	1050777-1	2001-8003-92	3	B	405
B3003	1050813-1	2001-8991-92	2 ¹	B	405
B3003	1089686-1 ²	2001-8203-92	2	B	405
B3004	1050779-1	2001-8004-92	3	B	402
B3004	1050792-1 ²	2001-8204-92	2	B	402
-3007	1050781-1	2001-8007-92	3	E	405
-3008	1050783-1	2001-8008-92	3	E	402
*B3101	1050785-1	2001-8101-92	1	B	405
*B3102	1050786-1	2001-8102-92	1	B	402
*B3103	1050787-1	2001-8103-92	3	B	405
*B3103	1050797-1 ²	2001-8303-92	2	B	405
*B3103	1050812-1	2001-8981-92	2 ¹	B	405

Military Part No.	AMP Part No.	M/A-COM ⁴ Part No. (Ref. Only)	Outline	Category	RG/U Cable
*B3103	227868-1 ³	—	4	B	405
*B3104	1050788-1	2001-8104-92	3	B	402
*B3104	1050799-1	2001-8304-92	2	B	402
*B3104	227743-1 ³	—	4	B	402
*-3107	1050789-1	2001-8107-92	3	E	405
*-3108	1050790-1	2001-8108-92	3	E	402
-3207	1050793-1	2001-8207-92	2	F	405
-3207	228639-3 ³	—	4	F	405
-3208	1050794-1	2001-8208-92	2	F	402
*-3307	1050800-1	2001-8307-92	2	F	405
*-3307	228639-1 ³	—	4	F	405
*-3308	1050801-1	2001-8308-92	2	F	402
*-3308	228634-1 ³	—	4	F	402
-3311	1050803-1	2001-8311-92	2	F	405

* No safety wire holes.

¹ Low profile version; overall length .393 [9.98] max.

² OSCC solderless compression crimp version.

³ Use Hand Tool Kit Part Number 59981-1 which includes Die Set Part Number 312253-2 and Locator Part Number 220221-2.

⁴ -92 indicates passivated stainless steel finish.

See page 7003 for description of categories and pages 7059-7064 for tooling (unless noted otherwise).

MIL-C-39012/80

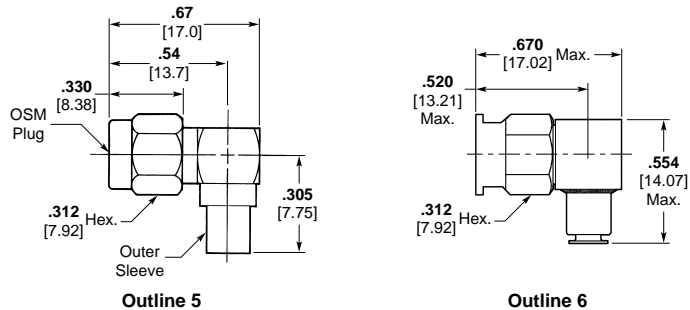

Military Part No.	AMP Part No.	M/A-COM ² Part No. (Ref. Only)	Outline	Category	RG/U Cable
B3001	1051160-1	2007-8001-92	5	B	405
B3002	1051161-1	2007-8002-92	5	B	402
B3003	1051163-1	2007-8003-92	5	B	405
B3004	1051164-1	2007-8004-92	5	B	402
-3005	1051165-1	2007-8005-92	5	E	405
-3006	1051166-1	2007-8006-92	5	E	402
-3007	1051168-1	2007-8007-92	5	E	405
-3008	1051170-1	2007-8008-92	5	E	402
*B3101	1051171-1	2007-8101-92	5	B	405
*B3102	1051172-1	2007-8102-92	5	B	402

Military Part No.	AMP Part No.	M/A-COM ² Part No. (Ref. Only)	Outline	Category	RG/U Cable
*B3103	1051173-1	2007-8103-92	5	B	405
*B3104	1051174-1	2007-8104-92	5	B	402
*-3105	1051175-1	2007-8105-92	5	E	405
*-3106	1051176-1	2007-8106-92	5	E	402
*-3107	1051177-1	2007-8107-92	5	E	405
*-3108	1051178-1	2007-8108-92	5	E	402
-3207	228583-3	—	6	F	405
*-3307	228583-1	—	6	F	405
-3308	228626-1	—	6	F	402

* No safety wire holes.

¹ Use Hand Tool Kit Part Number 59981-1 which includes Die Set Part Number 312253-1 and Locator Part Number 312173-1.

² -92 indicates passivated stainless steel finish.

See page 7003 for description of categories and pages 7059-7064 for tooling (unless noted otherwise).

SMA Connectors MIL-C-39012 — For Semi-Rigid Cable (Continued)

MIL-C-39012/81

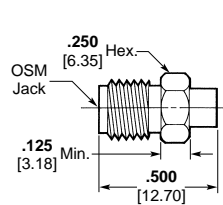

Outline 1

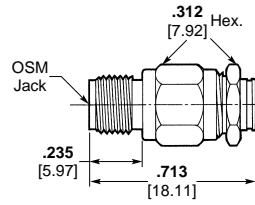

Outline 2

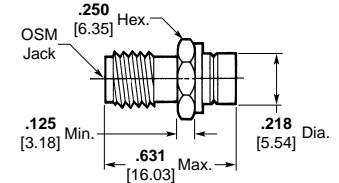

Outline 3

Military Part No.	AMP Part No.	M/A-COMP ² Part No. (Ref. Only)	Outline	Category	RG/U Cable
B3001	1050923-1	2002-8001-90	1	B	405
B3002	1050924-1	2002-8002-90	1	B	402
B3003	1084643-1	2002-8003-92	2	B	405
B3003	1050932-1 ¹	2002-8203-92	3	B	405
B3004	1050925-1	2002-8004-92	2	B	402
B3004	1050933-1 ¹	2002-8204-92	3	B	402

Military Part No.	AMP Part No.	M/A-COMP ² Part No. (Ref. Only)	Outline	Category	RG/U Cable
-3005	1050926-1	2002-8005-90	1	E	405
-3006	1050928-1	2002-8006-90	1	E	402
-3007	1050929-1	2002-8007-92	2	E	405
-3008	1050931-1	2002-8008-92	2	E	402
-3207	1050934-1 ¹	2002-8207-92	3	F	405
-3208	1050935-1 ¹	2002-8208-92	3	F	402

¹ OSCC solderless compression crimp version.
² -92 indicates passivated stainless steel finish.
 -90 indicates gold plated finish.
 See page 7003 for description of categories and pages 7059-7064 for tooling.

MIL-C-39012/82

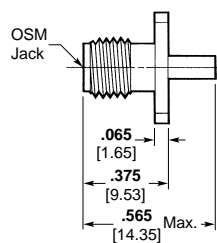
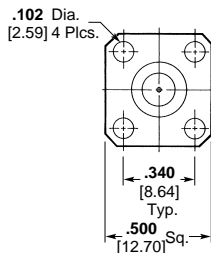

Outline 4

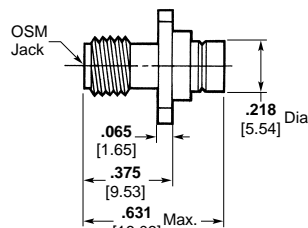

Outline 5

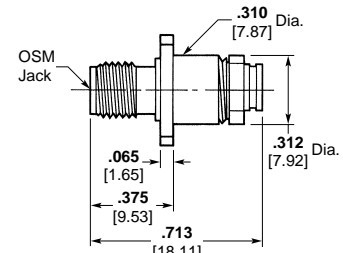

Outline 6

Military Part No.	AMP Part No.	M/A-COMP ² Part No. (Ref. Only)	Outline	Category	RG/U Cable
B3001	1051087-1	2006-8001-90	4	B	405
B3002	1051088-1	2006-8002-90	4	B	402
B3003	1051089-1	2006-8003-92	6	B	405
B3003	1051095-1 ¹	2006-8203-92	5	B	405
B3004	1051090-1	2006-8004-92	6	B	402
B3004	1051096-1 ¹	2006-8204-92	5	B	402

Military Part No.	AMP Part No.	M/A-COMP ² Part No. (Ref. Only)	Outline	Category	RG/U Cable
-3005	1051091-1	2006-8005-90	4	E	405
-3006	1051092-1	2006-8006-90	4	E	402
-3007	1051093-1	2006-8007-92	6	E	405
-3008	1051094-1	2006-8008-92	6	E	402
-3207	1051097-1 ¹	2006-8207-92	5	F	405
-3208	1051098-1 ¹	2006-8208-92	5	F	402

¹ OSCC solderless compression crimp version.
² -92 indicates passivated stainless steel finish.
 -90 indicates gold plated finish.
 See page 7003 for description of categories and pages 7059-7064 for tooling.

SMA Connectors MIL-C-39012 — For Semi-Rigid Cable (Continued)

MIL-C-39012/83

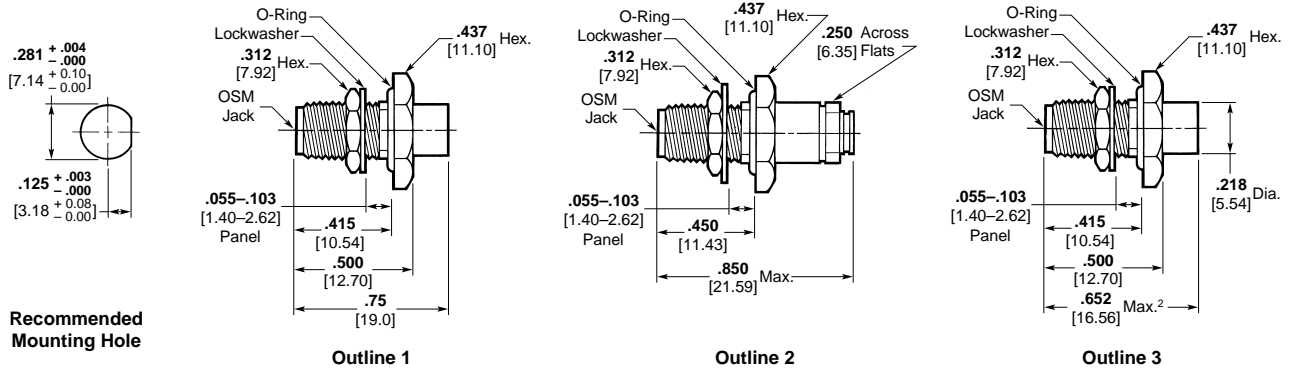

Military Part No.	AMP Part No.	M/A-COMP ³ Part No. (Ref. Only)	Outline	Category	RG/U Cable
B3001	1051022-1	2004-8001-90	1	B	405
B3002	1051023-1	2004-8002-90	1	B	402
B3003	1051024-1	2004-8003-92	2	B	405
B3003	1051030-1 ¹	2004-8203-92	3	B	405
B3004	1051025-1	2004-8004-92	2	B	402
B3004	1051031-1 ¹	2004-8204-92	3	B	402

Military Part No.	AMP Part No.	M/A-COMP ³ Part No. (Ref. Only)	Outline	Category	RG/U Cable
-3005	1051026-1	2004-8005-90	1	E	405
-3006	1051027-1	2004-8006-90	1	E	402
-3007	1051028-1	2004-8007-92	2	E	405
-3008	1051029-1	2004-8008-92	2	E	402
-3207	1051032-1 ^{1,2}	2004-8207-92	3	F	405
-3208	1051033-1 ^{1,2}	2004-8208-92	3	F	402

¹ OSCC Solderless Compression Crimp version.
² Category F Only: Overall Length; .620 [15.75] Max.
³ -92 indicates passivated stainless steel finish.
 -90 indicates gold plated finish.
 See page 7003 for description of categories and pages 7059-7064 for tooling.

MIL-C-39012/92

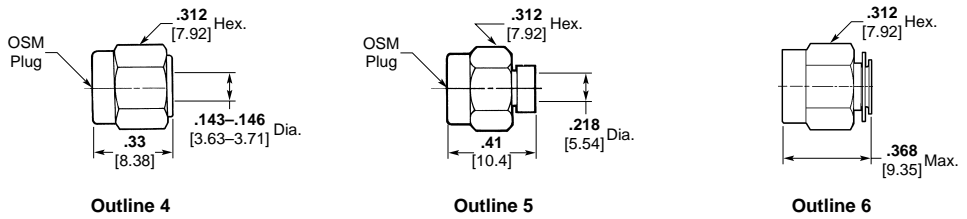

Military Part No.	AMP Part No.	M/A-COMP ³ Part No. (Ref. Only)	Outline	Category	RG/U Cable
B3001	1050805-1	2001-8901-92	4	B	402
B3001	1050808-1 ¹	2001-8921-92	5	B	402
B3001	1484517-1 ¹	2001-8941-92	4	B	402
*B3101	1050807-1	2001-8911-92	4	B	402
*B3101	1050809-1 ¹	2001-8931-92	5	B	402

Military Part No.	AMP Part No.	M/A-COMP ³ Part No. (Ref. Only)	Outline	Category	RG/U Cable
*B3101	1050810-1 ¹	2001-8951-92	4	B	402
B3101	227531-1 ²	—	6	B	402
-3201	1050791-1 ¹	2001-8201-92	5	F	402
*-3301	1050796-1 ¹	2001-8301-92	5	F	402
-3301	228635-1 ²	—	6	F	402

* No safety wire holes.
¹ OSCC Solderless Compression Crimp version.
² Use Hand Tool Kit Part Number 59981-1 which includes Die Set Part Number 312253-1 and Locator Part Number 220220-2.
³ -92 indicates passivated stainless steel finish.
 See page 7003 for description of categories and pages 7059-7064 for tooling.

SMA Connectors MIL-C-39012 — Printed Circuit Mount

MIL-C-39012/93

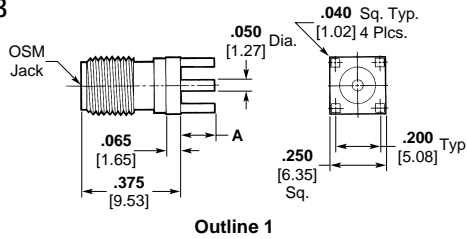

Military Part No.	AMP Part No.	M/A-COM ¹ Part No. (Ref. Only)	Outline	Dimension A
-3001	1053372-1	2062-8001-90	1	.155 3.94
-3002	1053374-1	2062-8002-90	1	.125 3.18
-3003	1053376-1	2062-8003-90	1	.093 2.36

¹ -90 indicates gold plated finish.

MIL-C-39012/94

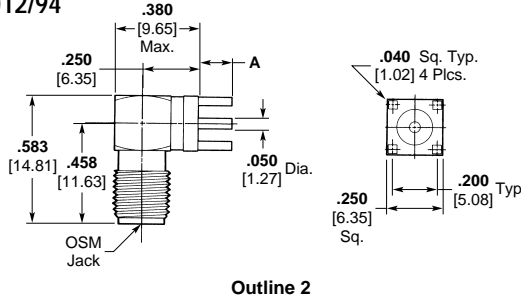

Military Part No.	AMP Part No.	M/A-COM ¹ Part No. (Ref. Only)	Outline	Dimension A
-3001	1053396-1	2064-8001-90	2	.155 3.94
-3002	1053398-1	2064-8002-90	2	.125 3.18
-3003	1053400-1	2064-8003-90	2	.093 2.36

¹ -90 indicates gold plated finish.

In-Series Adapters MIL-A-55339

MIL-A-55339

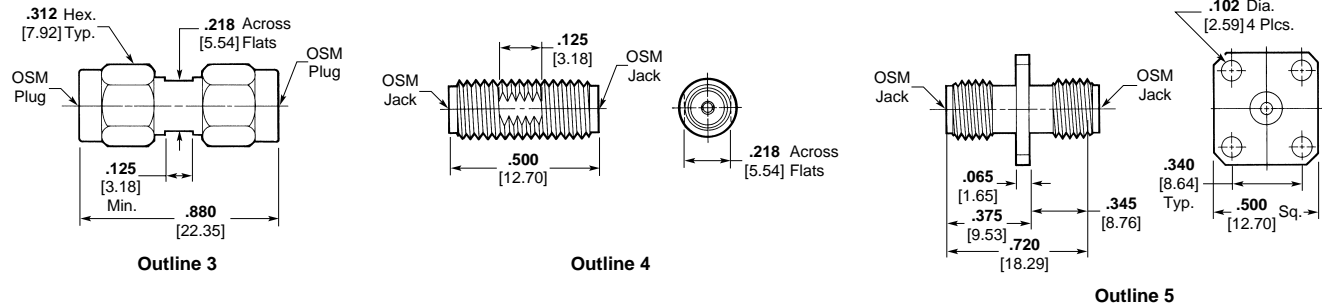
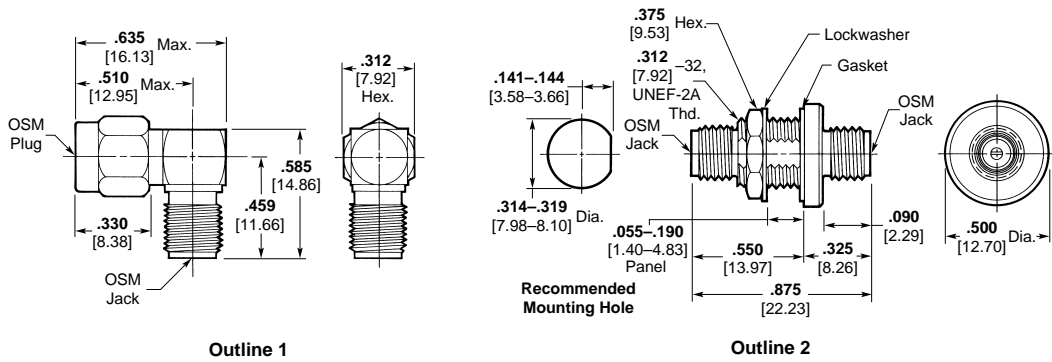

Military Part No.	AMP Part No.	M/A-COM ¹ Part No. (Ref. Only)	Outline
/02-30001	1055091-1	2088-8001-92	1
/28-30001	1054986-1	2084-8001-92	2
/28-30002	1054988-1	2084-8002-92	5
/29-30001	1053765-1	2081-8001-92	3
* /29-30101	1053767-1	2081-8101-92	3
/31-30001	1053633-1	2080-8001-92	4

* No safety wire holes.
¹ -92 indicates passivated stainless steel finish.

SMA Receptacles MIL-C-83517 — Panel Mount

MIL-C-83517/1

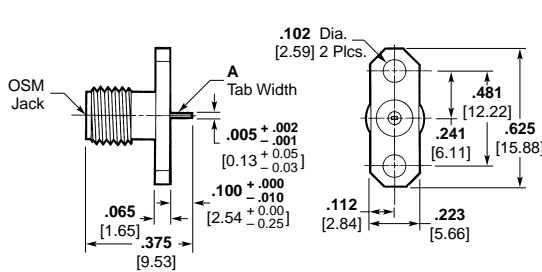

Outline 1

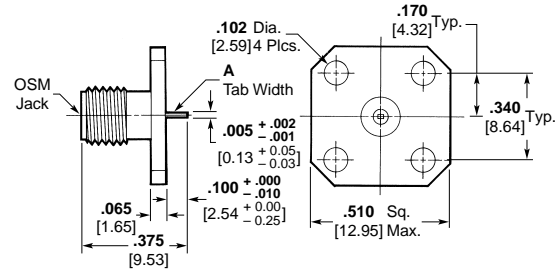

Outline 2

Military Part No.	AMP Part No.	M/A-COM ¹ Part No. (Ref. Only)	Outline	Dimension A
-31001	1052928-1	2052-8003-92	1	.020 ±.002 0.51 ±.051
-31002	1052930-1	2052-8004-92	1	.050 ±.001 1.27 ±.025
-31003	1052932-1	2052-8005-92	2	.020 ±.002 0.51 ±.051
-31004	1052934-1	2052-8006-92	2	.050 ±.001 1.27 ±.025

Military Part No.	AMP Part No.	M/A-COM ¹ Part No. (Ref. Only)	Outline	Dimension A
-32001	1052927-1	2052-8003-90	1	.020 ±.002 0.51 ±.051
-32002	1052929-1	2052-8004-90	1	.050 ±.001 1.27 ±.025
-32003	1052931-1	2052-8005-90	2	.020 ±.002 0.51 ±.051
-32004	1052933-1	2052-8006-90	2	.050 ±.001 1.27 ±.025

¹ -92 indicates passivated stainless steel finish.
-90 indicates gold plated finish.

MIL-C-83517/2

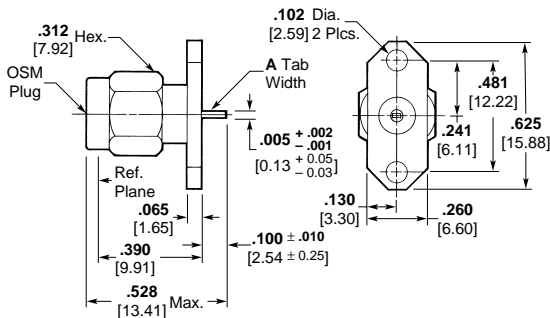

Outline 3

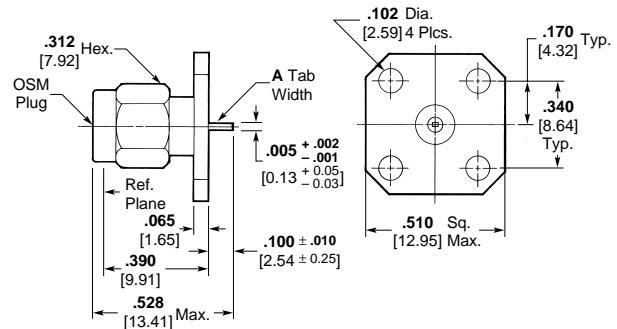

Outline 4

Military Part No.	AMP Part No.	M/A-COM ¹ Part No. (Ref. Only)	Outline	Dimension A
-31001	1052409-1	2051-8001-92	3	.020 ±.002 0.51 ±.051
-31002	1052411-1	2051-8002-92	3	.050 ±.001 1.27 ±.025
-31003	1052413-1	2051-8003-92	4	.020 ±.002 0.51 ±.051
-31004	1052415-1	2051-8004-92	4	.050 ±.001 1.27 ±.025

Military Part No.	AMP Part No.	M/A-COM ¹ Part No. (Ref. Only)	Outline	Dimension A
-32001	1052408-1	2051-8001-90	3	.020 ±.002 0.51 ±.051
-32002	1052410-1	2051-8002-90	3	.050 ±.001 1.27 ±.025
-32003	1052412-1	2051-8003-90	4	.020 ±.002 0.51 ±.051
-32004	1052414-1	2051-8004-90	4	.050 ±.001 1.27 ±.025

¹ -92 indicates passivated stainless steel finish.
-90 indicates gold plated finish.

SMA Receptacles MIL-C-83517 — Panel Mount (Continued)

MIL-C-83517/3

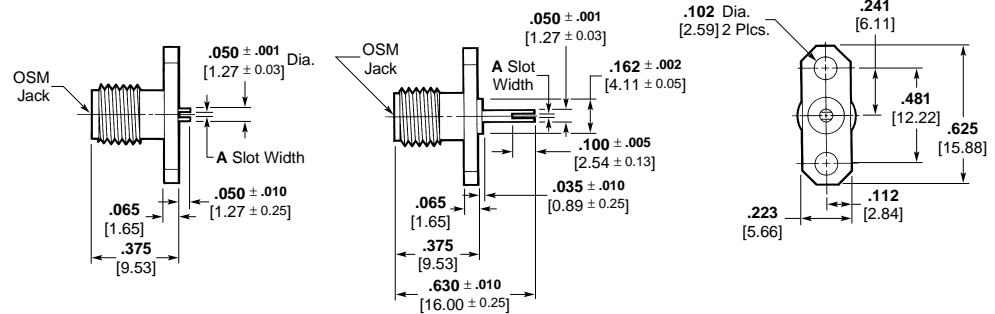

Outline 1

Outline 2

Outline 3

Military Part No.	AMP Part No.	M/A-COM ¹ Part No. (Ref. Only)	Outline	Dimension A
-31001	1052936-1	2052-8007-92	1	.012 +.003/-.001 0.30 +0.08/-0.03
-31002	1052938-1	2052-8008-92	1	.018 +.003/-.001 0.46 +0.08/-0.03
-31003	1052940-1	2052-8009-92	1	.028 +.003/-.001 0.71 +0.08/-0.03
-31004	1052942-1	2052-8010-92	3	.012 +.003/-.001 0.30 +0.08/-0.03
-31005	1052944-1	2052-8011-92	3	.018 +.003/-.001 0.46 +0.08/-0.03
-31006	1052946-1	2052-8012-92	3	.028 +.003/-.001 0.71 +0.08/-0.03
-31007	1052948-1	2052-8013-92	2	.025 ±.002 0.64 ±0.05

¹ -92 indicates passivated stainless steel finish.
-90 indicates gold plated finish.

Military Part No.	AMP Part No.	M/A-COM ¹ Part No. (Ref. Only)	Outline	Dimension A
-32001	1052935-1	2052-8007-90	1	.012 +.003/-.001 0.30 +0.08/-0.03
-32002	1052937-1	2052-8008-90	1	.018 +.003/-.001 0.46 +0.08/-0.03
-32003	1052939-1	2052-8009-90	1	.028 +.003/-.001 0.71 +0.08/-0.03
-32004	1052941-1	2052-8010-90	3	.012 +.003/-.001 0.30 +0.08/-0.03
-32005	1052943-1	2052-8011-90	3	.018 +.003/-.001 0.46 +0.08/-0.03
-32006	1052945-1	2052-8012-90	3	.028 +.003/-.001 0.71 +0.08/-0.03
-32007	1052947-1	2052-8013-90	2	.025 ±.002 0.64 ±0.05

SMA Receptacles MIL-C-83517 — Panel Mount (Continued)

MIL-C-83517/4

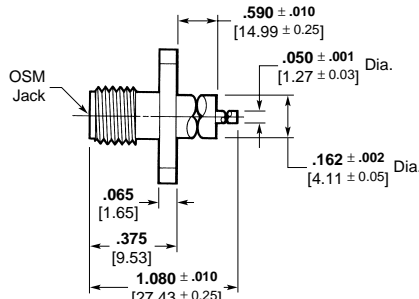

Outline 1

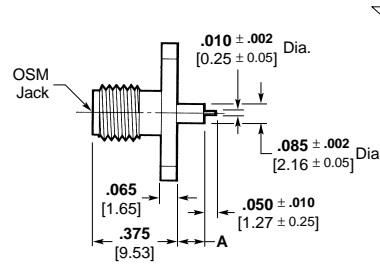

Outline 2

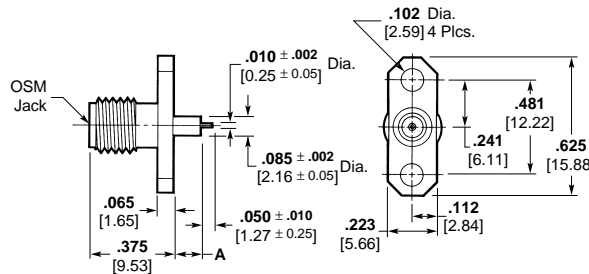
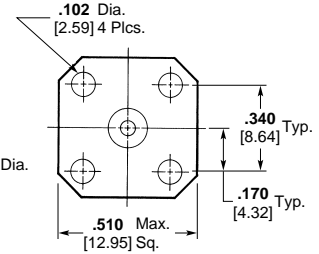

Outline 3

Military Part No.	AMP Part No.	M/A-COM ¹ Part No. (Ref. Only)	Outline	Dimension A
-31001	1052950-1	2052-8014-92	3	.057 ±.003 1.45 ±.076
-31002	1052952-1	2052-8015-92	3	.125 ±.003 3.18 ±.076
-31003	1052954-1	2052-8016-92	2	.057 ±.003 1.45 ±.076
-31004	1052956-1	2052-8017-92	2	.125 ±.003 3.18 ±.076
-31005	1052958-1	2052-8018-92	1	N/A

Military Part No.	AMP Part No.	M/A-COM ¹ Part No. (Ref. Only)	Outline	Dimension A
-32001	1052949-1	2052-8014-90	3	.057 ±.003 1.45 ±.076
-32002	1052951-1	2052-8015-90	3	.125 ±.003 3.18 ±.076
-32003	1052953-1	2052-8016-90	2	.057 ±.003 1.45 ±.076
-32004	1052955-1	2052-8017-90	2	.125 ±.003 3.18 ±.076
-32005	1052957-1	2052-8018-90	1	N/A

¹ -92 indicates passivated stainless steel finish.
-90 indicates gold plated finish.

MIL-C-83517/5

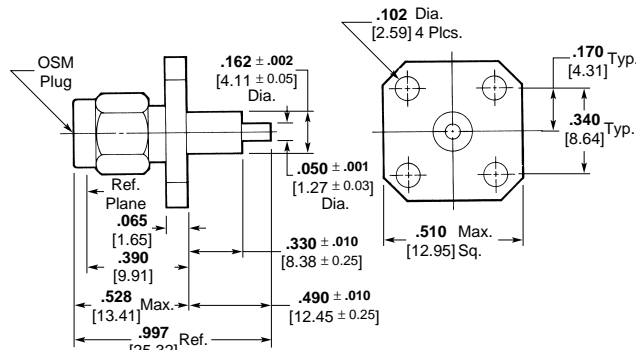

Outline 4

Military Part No.	AMP Part No.	M/A-COM ¹ Part No. (Ref. Only)	Outline
-31001	1052417-1	2051-8005-92	4
-32001	1052416-1	2051-8005-90	4

¹ -92 indicates passivated stainless steel finish.
-90 indicates gold plated finish.

SMA Receptacles MIL-C-83517 — Surface Launch

MIL-C-83517/6

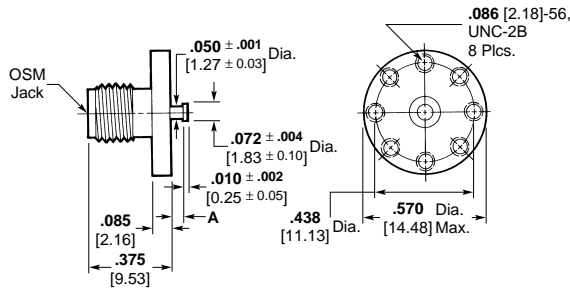

Outline 1

Military Part No.	AMP Part No.	M/A-COM ¹ Part No. (Ref. Only)	Outline	Dimension A
-31001	1053423-1	2066-8001-92	1	.060 ± .003 1.52 ± 0.08
-31002	1053425-1	2066-8002-92	1	.120 ± .003 3.05 ± 0.08
-32001	1053422-1	2066-8001-90	1	.060 ± .003 1.52 ± 0.08
-32002	1053424-1	2066-8002-90	1	.120 ± .003 3.05 ± 0.08

¹ -92 indicates passivated stainless steel finish.
-90 indicates gold plated finish.

MIL-C-83517/7

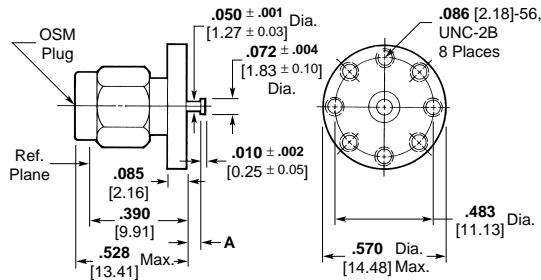

Outline 2

Military Part No.	AMP Part No.	M/A-COM ¹ Part No. (Ref. Only)	Outline	Dimension A
-31001	1053429-1	2067-8001-92	2	.060 ± .003 1.52 ± 0.08
-31002	1053431-1	2067-8002-92	2	.120 ± .003 3.05 ± 0.08
-32001	1053428-1	2067-8001-90	2	.060 ± .003 1.52 ± 0.08
-32002	1053430-1	2067-8002-90	2	.120 ± .003 3.05 ± 0.08

¹ -92 indicates passivated stainless steel finish.
-90 indicates gold plated finish.

MIL-C-83517/8

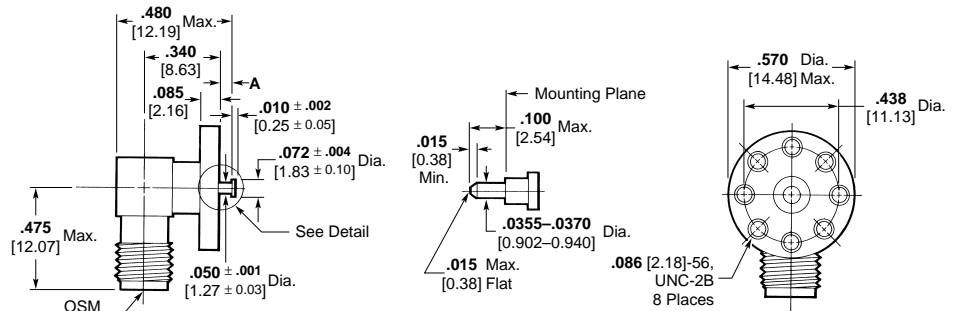

Detail Transition End

Outline 3

Military Part No.	AMP Part No.	M/A-COM ¹ Part No. (Ref. Only)	Outline	Dimension A
-31001	1053451-1	2068-8001-92	3	.060 ± .003 1.52 ± 0.08
-31002	1053453-1	2068-8002-92	3	.120 ± .003 3.05 ± 0.08
-32001	1053450-1	2068-8001-90	3	.060 ± .003 1.52 ± 0.08
-32002	1053452-1	2068-8002-90	3	.120 ± .003 3.05 ± 0.08

¹ -92 indicates passivated stainless steel finish.
-90 indicates gold plated finish.

SMA Receptacles MIL-C-83517 — End Launch

MIL-C-83517/9

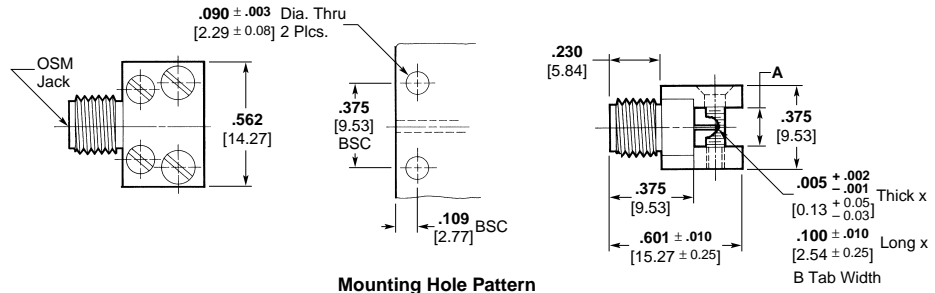

Mounting Hole Pattern

Outline 1

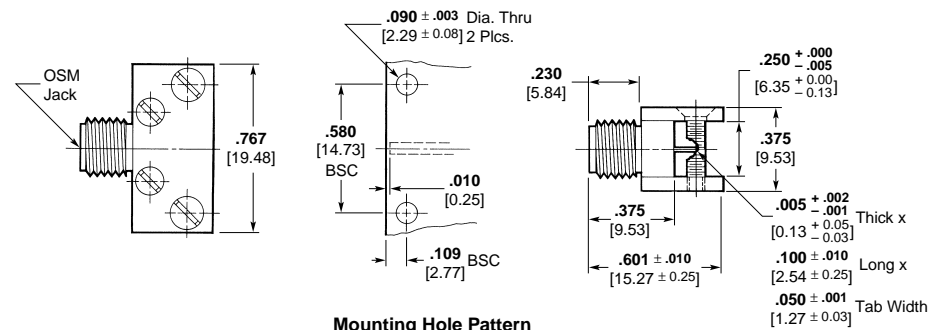

Mounting Hole Pattern

Outline 2

Military Part No.	AMP Part No.	M/A-COM ¹ Part No. (Ref. Only)	Outline	Dimension A	Dimension B
-31001	1053476-1	2070-8001-92	1	.057-.064 1.45-1.63	.025 ± .002 0.64 ± 0.05
-31002	1053478-1	2070-8002-92	1	.120-.127 3.05-3.23	.050 ± .001 1.27 ± 0.03
-31003	1053480-1	2070-8003-92	1	.245-.250 6.22-6.35	.050 ± .001 1.27 ± 0.03
-31004	1053482-1	2070-8004-92	2	N/A	N/A
-32001	1053475-1	2070-8001-90	1	.057-.064 1.45-1.63	.025 ± .002 0.64 ± 0.05
-32002	1053477-1	2070-8002-90	1	.120-.127 3.05-3.23	.050 ± .001 1.27 ± 0.03
-32003	1053479-1	2070-8003-90	1	.245-.250 6.22-6.35	.050 ± .001 1.27 ± 0.03
-32004	1053481-1	2070-8004-90	2	N/A	N/A

¹ -92 indicates passivated stainless steel finish.
-90 indicates gold plated finish.

MIL-C-83517/10

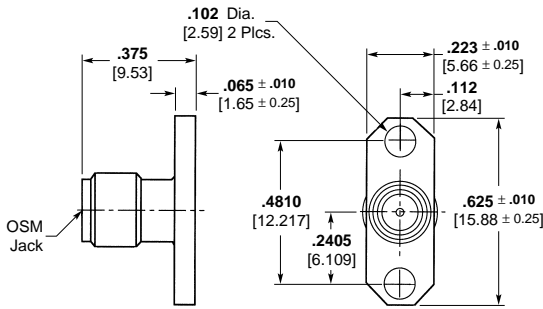

Outline 1

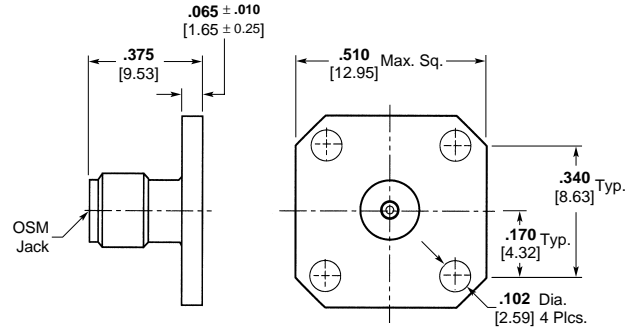

Outline 2

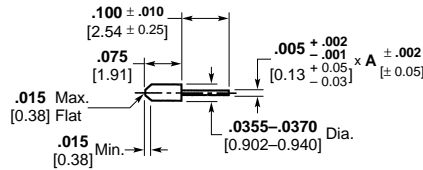

Transition Pin Detail

Military Part No.	AMP Part No.	M/A-COM ¹ Part No. (Ref. Only)	Outline	Dimension A
-31001	1052959-1	2052-8019-92	1	—
-31003	1052962-1	2052-8021-92	2	—
-31005	1052963-1	2052-8023-92	1	.020 ± .002 0.51 ± 0.05
-31006	1484518-1	2052-8024-92	1	.050 ± .002 1.27 ± 0.05
-31015	1484519-1	2052-8033-92	2	.020 ± .002 0.51 ± 0.05
-31016	1484520-1	2052-8034-92	2	.050 ± .002 1.27 ± 0.05
-32001	1484521-1	2052-8019-90	1	—
-32003	1052961-1	2052-8021-90	2	—
-32005	1484522-1	2052-8023-90	1	.020 ± .002 0.51 ± 0.05
-32006	1484523-1	2052-8024-90	1	.050 ± .002 1.27 ± 0.05
-32015	1484524-1	2052-8033-90	2	.020 ± .002 0.51 ± 0.05
-32016	1484525-1	2052-8034-90	2	.050 ± .002 1.27 ± 0.05

¹ -92 indicates passivated stainless steel finish.
-90 indicates gold plated finish.

SMA Connectors for Semi-Rigid Cable

Captured Center Contact

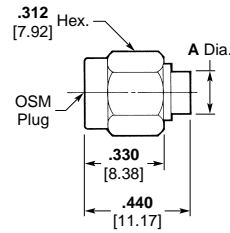

Outline 66

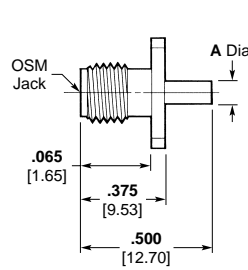

Outline 67

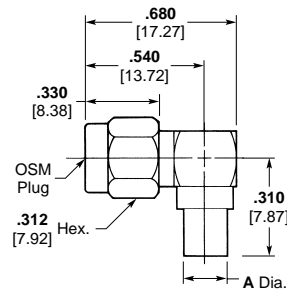
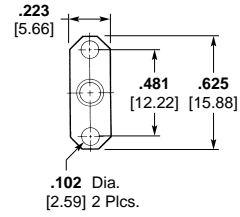

Outline 68

DSCC Part Number	M/A-COM Part Number (Ref. Only)	Outline	Dim. A	Assembly Procedure 408-	RG/U Cable	AMP Part Number
84149SSG	2001-5397-02	66	.180 4.57	4943	402	1050605-1
84149SSG-1	2001-5557-02	66	.180 4.57	4764	402	1050629-1
84149SSGA	2001-5431-02	66	.120 3.05	—	405	1050609-1
84149SSGA-1	2001-5558-02	66	.120 3.05	4765	405	1050631-1
85022SSG	2006-5151-00	67	.180 4.57	—	402	1051063-1
85022SSG-1	2006-5192-00	67	.180 4.57	4767	402	1221162-1
85022SSGA	2006-5150-00	67	.120 3.05	4857	405	1051062-1
85022SSGA-1	2006-5193-00	67	.120 3.05	4833	405	1051067-1
85037SSG	2007-5115-02	68	.180 4.57	4830	402	1051119-1
85037SSGA	2007-5116-02	68	.120 3.05	—	405	1051120-1

* Defense Electronics Supply Center, Dayton, Ohio

SSMA Connectors for Semi-Rigid Cable and Flexible Cable

Non-Captured Center Contact

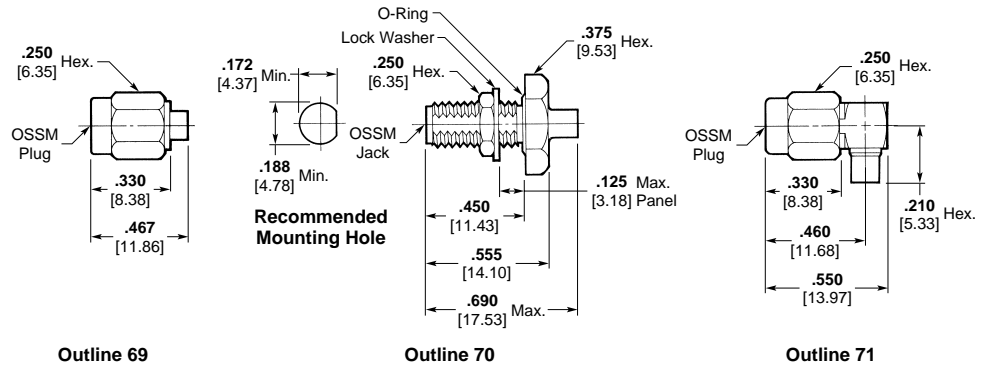

DSCC Part Number	M/A-COM Part Number (Ref. Only)	Outline	Assembly Procedure 408-	RG/U Cable	AMP Part Number
86116ZSG	1001-5045-92	69	4622	405	1045358-1
86117ZSG	1004-5005-90	70	—	405	1045398-1
86118ZSG	1007-5015-92	71	4968	405	1045418-1

Captured Center Contact

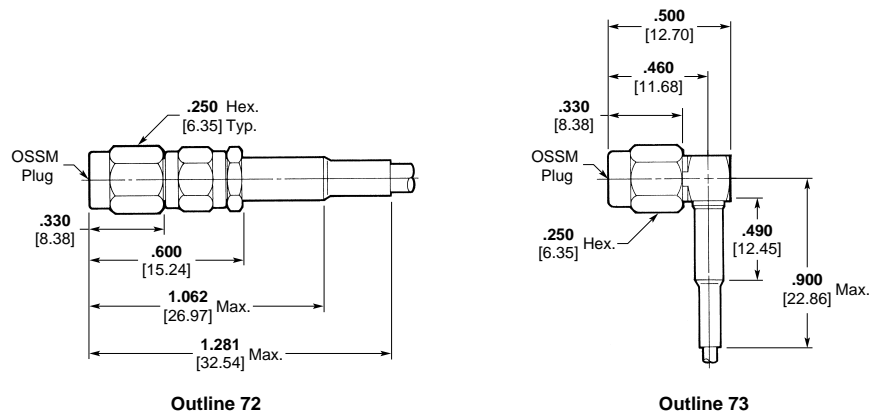

DSCC Part Number	M/A-COM Part Number (Ref. Only)	Outline	Assembly Procedure 408-	RG/U Cable	AMP Part Number
86119ZSG	1031-5031-92	72	—	174, 316, 179	1045486-1
86120ZSG	1037-5032-92	73	4759	174, 316, 179	1045517-1

* Defense Electronics Supply Center, Dayton, Ohio

BMA Blindmate Connectors for Semi-Rigid and Flexible Cable

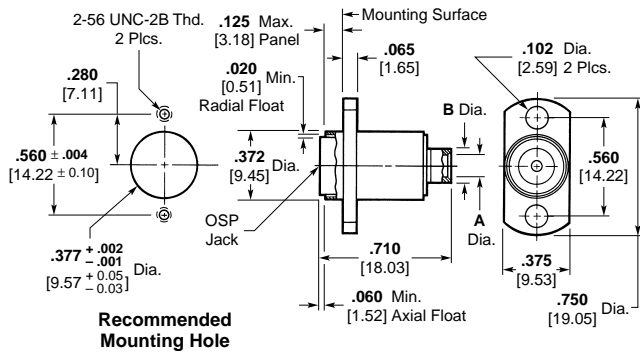

Outline 74

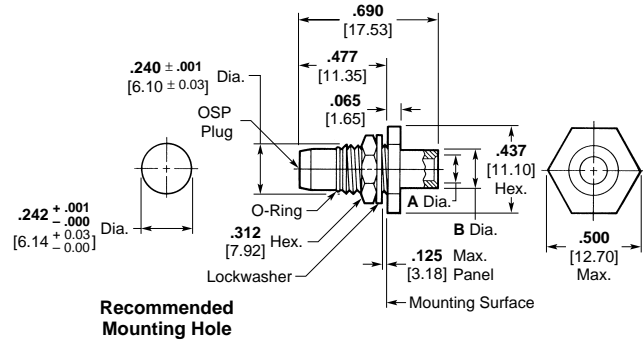

Outline 75

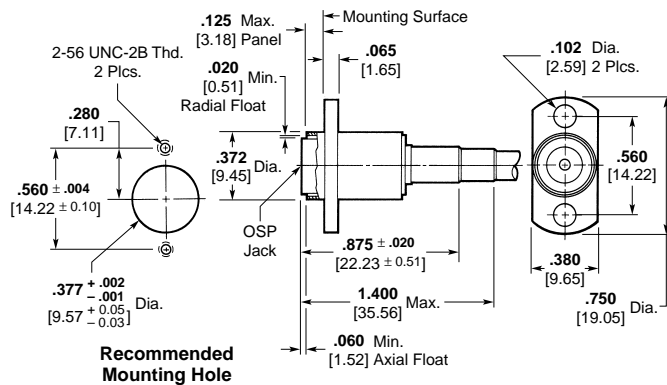

Outline 76

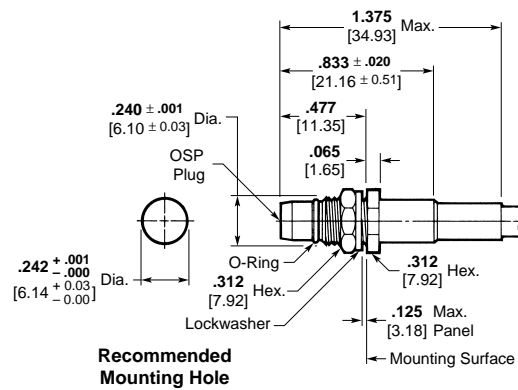

Outline 77

DSCC Part Number	M/A-COM Part Number (Ref. Only)	Outline	Assembly Procedure 408-	RG/U Cable	AMP Part Number
85071ZSGA	4506-5015-02 ¹	74	8260	402	1059424-1
85071ZSGB	4506-5016-02 ¹	74	8263	405	1059426-1
85072ZSGA	4503-5022-00 ²	75	8259	402	1059384-1
85072ZSGB	4503-5023-00 ²	75	8265	405	1059386-1
85073ZSGA	4536-5007-02 ³	76	8266	179, 55, 187, 188, 316	1059529-1
85073ZSGB	4536-5008-02 ³	76	8267	55, 142, 223, 400	1059530-1
85074ZSGA	4533-5007-02 ³	77	8271	179, 174, 187, 188, 316	1059518-1
85074ZSGB	4533-5008-02 ³	77	8270	55, 142, 223, 400	1059519-1

¹ Finish: Inner housing that is soldered to cable is gold plated. Outer housing is passivated stainless steel.
² Finish: Housing that is soldered to cable outer conductor is gold plated.
³ Finish: Passivated stainless steel. For gold plate, change the Part Number suffix from -02 to -00.

* Defense Electronics Supply Center, Dayton, Ohio

OSMP Microminiature Push-On Coaxial Connectors for Semi-Rigid Cable

Straight Cable Jack Solder Attachment

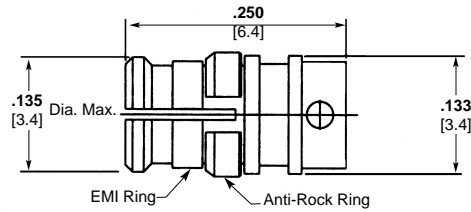

DSCC Part Number	M/A-COM Part Number (Ref. Only)	RG/U Cable	AMP Part Number
94008ZCG-2	2902-5005-62	.047 Semi-Rigid	1056521-1
94008ZCG-1	2902-5006-62	RG-405	1056522-1

Right Angle Cable Jack Solder Attachment

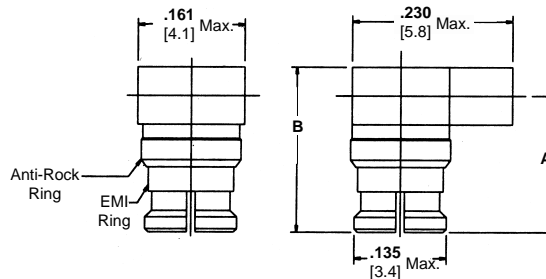

DSCC Part Number	M/A-COM Part Number (Ref. Only)	RG/U Cable	AMP Part Number
94008ZCG-4	2908-5006-62	.047 Semi-Rigid	1056550-1
94008ZCG-3	2908-5007-62	RG-405	1056551-1

Jack to Jack Adapter (Bullet)

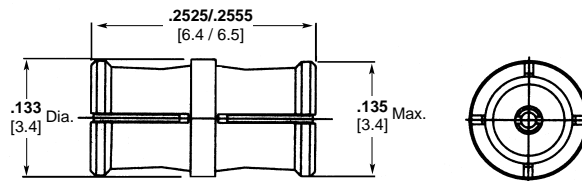

DSCC Part Number	M/A-COM Part Number (Ref. Only)	RG/U Cable	AMP Part Number
94007ZCG-1	2980-5004-62	—	1056703-1

Shroud – 2-Hole Flange Surface Mount

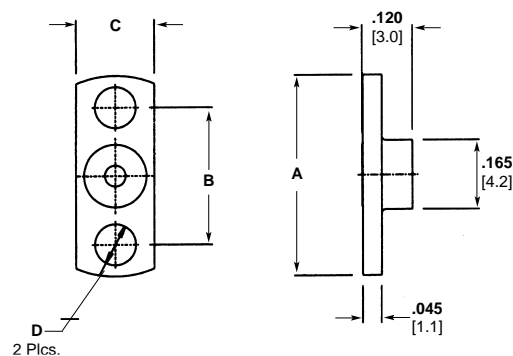

DSCC Part No.	M/A-COM ¹ Part No. (Ref. Only)	Dimension A	Dimension B	Dimension C	Dimension D	AMP Part Number
94007ZSP-3	2998-5039-02	.480 12.2	.328 8.3	.187 4.7	.098 2.5	1056740-1
94007ZSP-4	2998-5040-02	.625 15.8	.481 12.2	.223 5.7	.102 2.6	1056741-1
94007ZSP-5	2998-5041-02	.400 10.2	.282 7.2	.165 4.2	.073 1.9	1056742-1

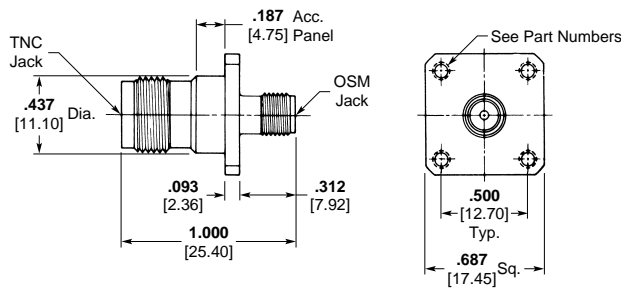

Outline 78

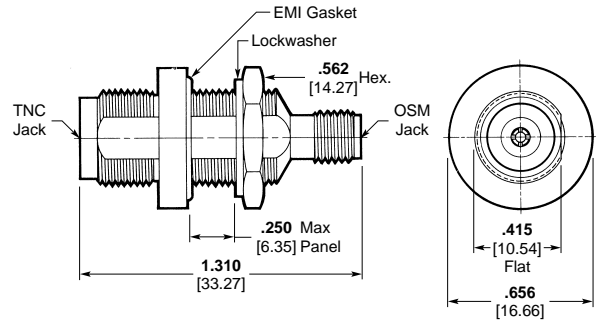

Outline 79

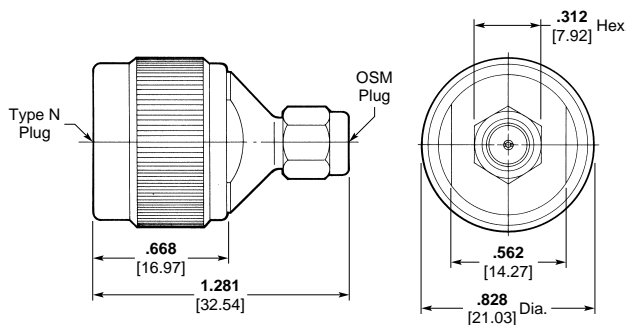

Outline 80

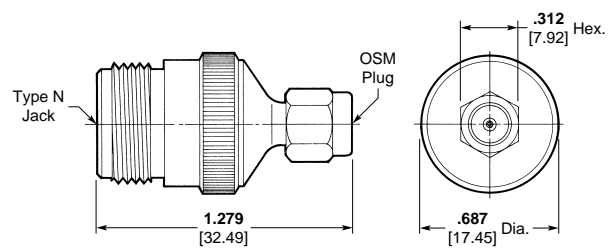

Outline 81

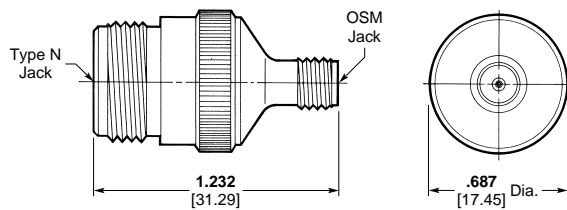

Outline 82

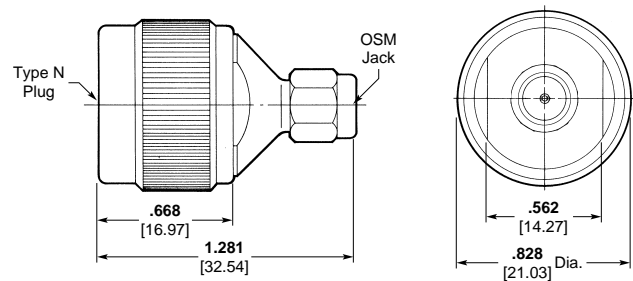

Outline 83

DSCC Part Number	M/A-COM Part Number (Ref. Only)	Outline	Description	AMP Part Number
8501814FP-1 ¹	3180-4034-02 ¹	78	SMA Jack to TNC Jack	1057848-1
8501814FP-2 ²	3180-4036-02 ²	78	SMA Jack to TNC Jack	1080294-1
8501814FP-3	3184-4002-02	79	SMA Jack to TNC Jack	1057911-1
8604412SP-1	3181-4002-02	80	SMA Plug to Type N Plug	1057311-1
8604412SP-2	3082-4022-02	81	SMA Plug to Type N Jack	1057400-1
8604412SP-3	3080-4014-02	82	SMA Jack to Type N Jack	1057356-1
8604412SP-4	3082-4031-02	83	TNC Plug to SMA Jack	1057403-1

¹ .125 [3.20] Dia. Typ. (4 Plcs.)

² Tapped holes to accommodate 3-56 UNF mounting screws.

* Defense Electronics Supply Center, Dayton, Ohio

Between Series Adapters (Continued)

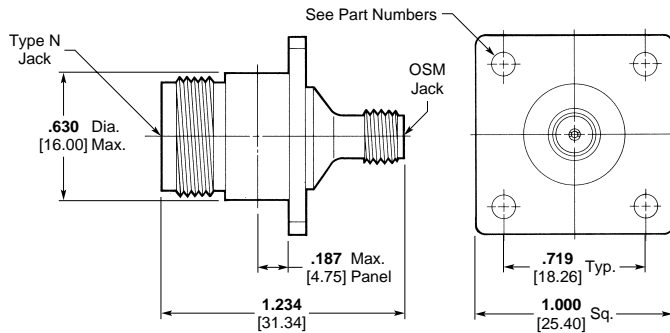

Outline 83

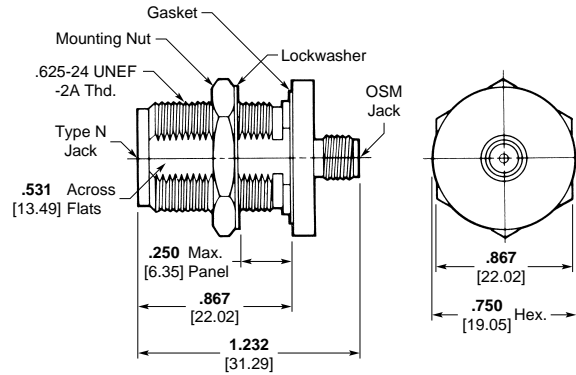

Outline 84

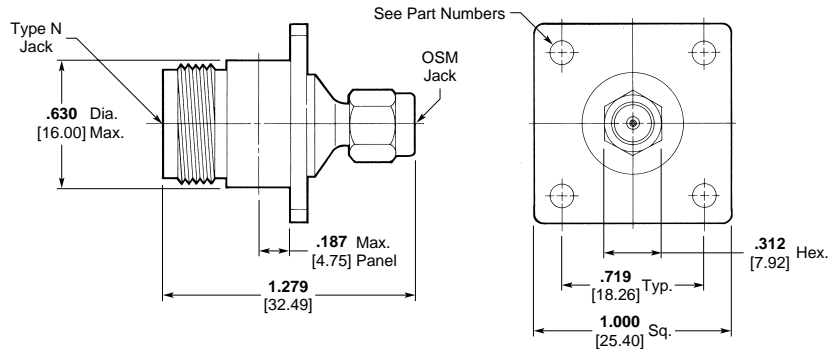

Outline 85

DSCC Part Number	M/A-COM Part Number (Ref. Only)	Outline	Description	AMP Part Number
8503812FP-1 ¹	3080-4010-02 ¹	83	SMA Jack to Type N Jack	1057354-1
8503812FP-2 ²	3080-4015-02 ²	83	SMA Jack to Type N Jack	1057357-1
8503812FP-3	3084-4001-00	84	SMA Jack to Type N Jack	1057465-1
8503812FP-4 ¹	3082-4028-02 ¹	85	SMA Plug to Type N Jack	1057402-1
8503812FP-5 ²	3082-4029-02 ²	85	SMA Plug to Type N Jack	1252992-1
8503812FP-6 ¹	3080-4019-02 ¹	83	SMA Jack to Type N Jack	1057359-1
8503812FP-7 ²	3080-4020-02 ²	83	SMA Jack to Type N Jack	1087866-1

¹ .125 [3.20] Dia. Typ. (4 Plcs.)

² Tapped holes to accommodate 3-56 UNF mounting screws.

* Defense Electronics Supply Center, Dayton, Ohio

One-Step BNC/TNC Connectors

Product Facts

- Easy, quick installation
- Outstanding cable-retention force
- Solder-solder connection type (center conductor and braid)
- One-step termination for easy, quick installation and lower installed cost
- Exceptional cable retention force to withstand high vibration and frequent mates and unmates
- Fully soldered center conductor and braid
- Excellent built-in strain relief against vibration and excessive handling
- Long-term reliability
- Controlled soldering termination
- Use with standard RG/U cables and Raychem Cheminax cables
- Three product sizes to accommodate a wide range of cables
- Meets performance requirements of MIL-C-39012 up to 2.8 GHz

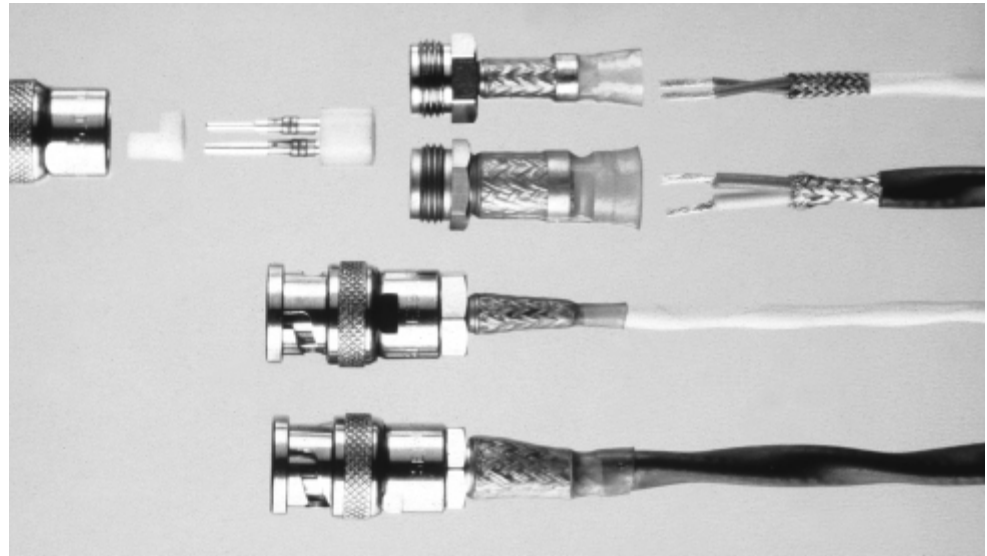

Applications

One-Step BNC/TNC connectors are single-piece assemblies for terminating the center conductor and the braid of a broad range of coaxial cables.

The connectors are fully intermateable with MIL-C-39012 connectors and are available in 50-ohm and 75-ohm versions.

Specifications

Raychem
RB-115

Installation

For proper installation of these devices, the correct heating tool and reflector attachment must be used. Any one of the following Raychem heating tools is recommended:

- Steinel Model HL1802E
- CV-1981

Refer to Raychem installation procedure RPIP 683-00 for detailed instructions.

METRIC

Dimensions are millimeters over inches

Product Options and Part Numbering System

RXX - XX - X - XX	Connector Style		Connector Type		
	Dash No. -XX	Style	TNC	BNC	
-00		Straight plug			
-01		Right-angle plug			
-02		Straight bulkhead jack			
-03		Straight jack			
-04		Straight panel jack			
Connector size			4 x M2.5 x 0.45		
L = Large					
M = Medium					
S = Small					
50 = 50 ohms					
75 = 75 ohms					
D = Nickel-plated brass body, gold-plated brass pin					
B = BNC					
T = TNC					

Example: RBD-50-L-00 is a BNC connector, 50 ohms, large size, with straight plug body.

METRIC
Dimensions are millimeters over inches

Product Characteristics

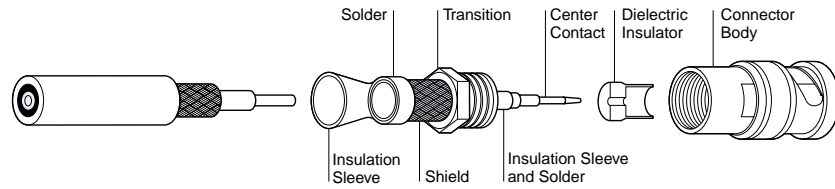

Material

Center contact	Gold-plated beryllium copper (female)
Dielectric insulator	Gold-plated brass (male)
Transition	PTFE
Connector body	Silver-plated brass
Solder and flux	Nickel-plated brass
Braided shield	Sn63Pb37, RMA flux
Insulation sleeve	Tin-plated copper wire per ASTM B3
Strain relief/sealing sleeve	Radiation-crosslinked, heat-shrinkable polyvinylidene fluoride, transparent blue
	Radiation-crosslinked, heat-shrinkable modified polyolefin with adhesive, black

Typical Performance

Dielectric withstand voltage	1500 V
Insulation resistance	5000 megohms
Temperature rating	-55°C to 150°C [-67°F to 302°F]
Contact resistance-straight	Inner = 1.5 milliohms, outer = 1.0 milliohm
Contact resistance — right-angle	Inner = 2.5 milliohms, outer = 1.5 milliohms
Cable retention force	295N (66 lb) to 822N (196 lb)
Voltage rating	500 V RMS
Connector durability	500 mating cycles minimum

Electrical Performance

Nominal impedance	50 and 75 ohms
Frequency range	Up to 2.8 GHz

Part Selection Process

1. From Product Options and Dimensions on page 7035, select the connector style you need (BNC or TNC, plug or jack, male or female contacts).
2. From the tables that follow, find the appropriate table for the connector style you selected.
3. From the appropriate table, select the connector part number based on the RG cable type or Raychem cable part number. For cable types not shown use the cable dimensions.
Note: The cable dimensions in each table are keyed to the diagram below.

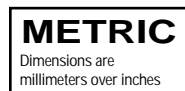
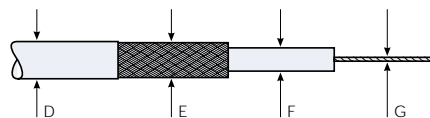

BNC Coaxial Connectors

Impedance (ohms)	Cable Type		Cable Dimensions				Part No.
	RG Cables	Raychem Cables	D (Min.-Max.)	E (Min.-Max.)	F (Max.)	G (Max.)	
BNC Straight Plugs, Male Contacts							
50	RG-174, RG-178, RG-188, RG-196, RG-316	5026A1311, 5028A1317, 5030A1317	1.50-5.50 [.060-.217]	0.90-3.00 [.035-.118]	1.55 [.060]	0.65 [.025]	RBD-50-S-00
50	RG-58, RG-141, RG-142, RG-303, RG-400	5019D3318, 5021D1331, 5020A1311	3.50-7.00 [.138-.276]	2.10-5.00 [.083-.197]	3.00 [.118]	1.25 [.050]	RBD-50-M-00
50	RG-165, RG-215, RG-213, RG-225, RG-214	5012F3332, 5012A3311	5.00-12.50 [.197-.500]	4.10-9.50 [.161-.375]	7.30 [.287]	2.45 [.100]	RBD-50-L-00
75	RG-179, RG-187	7530A1317	1.50-5.00 [.060-.217]	5 0.90-3.00 [.035-.118]	1.55 [.060]	0.65 [.025]	RBD-75-S-00
75	—	7524A1311, 7528A1317	3.50-7.00 [.138-.276]	2.10-5.00 [.083-.197]	3.70 [.126]	1.25 [.050]	RBD-75-M-00
75	RG-6, RG-11, RG-12, RG-59, RG-144, RG-216	—	5.00-12.50 [.197-.500]	4.10-9.50 [.161-.375]	7.3 [.287]	2.45 [.100]	RBD-75-L-00
BNC Right-Angle Plugs, Male Contacts							
50	RG-174, RG-178, RG-188, RG-196, RG-316	5026A1311, 5028A1317, 5030A1317	1.50-5.50 [.060-.217]	0.90-3.00 [.035-.118]	1.55 [.060]	0.65 [.025]	RBD-50-S-01
50	RG-58, RG-141, RG-142, RG-303, RG-400	5019D3318, 5021D1331, 5020A1311	3.50-7.00 [.138-.276]	2.10-5.00 [.083-.197]	3.00 [.118]	1.25 [.050]	RBD-50-M-01
50	RG-165, RG-215, RG-213, RG-225, RG-214	5012F3332, 5012A3311	5.00-12.50 [.197-.500]	4.1-9.50 [.161-.375]	7.30 [.287]	2.45 [.100]	RBD-50-L-01
75	RG-179, RG-187	7530A1317	1.50-5.50 [.060-.217]	0.9-3.00 [.035-.118]	1.55 [.060]	0.65 [.025]	RBD-75-S-01
75	—	524A1311, 7528A1317	3.50-7.00 [.138-.276]	2.1-5.00 [.083-.197]	3.70 [.146]	1.25 [.050]	RBD-75-M-01
75	RG-6, RG-11, RG-12, RG-59, RG-144, RG-216	—	5.00-12.50 [.197-.500]	4.1-9.50 [.161-.375]	7.30 [.287]	2.45 [.100]	RBD-75-L-01
BNC Straight Bulkhead Jacks, Female Contacts							
50	RG-174, RG-178, RG-188, RG-196, RG-316	5026A1311, 5028A1317, 5030A1317	1.50-5.50 [.060-.217]	0.90-3.00 [.035-.118]	1.55 [.060]	0.65 [.025]	RBD-50-S-02
50	RG-58, RG-141, RG-142, RG-303, RG-400	5019D3318, 5021D1331, 5020A1311	3.50-7.00 [.138-.276]	2.10-5.00 [.083-.197]	3.00 [.118]	1.25 [.050]	RBD-50-M-02
50	RG-165, RG-215, RG-213, RG-225, RG-214	5012F3332, 5012A3311	5.00-12.50 [.197-.500]	4.10-9.50 [.161-.375]	7.30 [.287]	2.45 [.100]	RBD-50-L-02
75	RG-179, RG-187	7530A1317	1.50-5.00 [.060-.217]	5 0.90-3.00 [.035-.118]	1.55 [.060]	0.65 [.025]	RBD-75-S-02
75	—	75 7524A1311, 7528A1317	3.50-7.00 [.138-.276]	2.10-5.00 [.083-.197]	3.70 [.146]	1.25 [.050]	RBD-75-M-02
75	RG-6, RG-11, RG-12, RG-59, RG-144, RG-216	—	5.00-12.50 [.197-.500]	4.10-9.50 [.161-.375]	7.30 [.287]	2.45 [.100]	RBD-75-L-02
BNC Straight Jacks, Female Contacts							
50	RG-174, RG-178, RG-188, RG-196, RG-316	5026A1311, 5028A1317, 5030A1317	1.50-5.50 [.060-.217]	0.90-3.00 [.035-.118]	1.55 [.060]	0.65 [.025]	RBD-50-S-03
50	RG-58, RG-141, RG-142, RG-303, RG-400	5019D3318, 5021D1331, 5020A1311	3.50-7.00 [.138-.276]	2.10-5.00 [.083-.197]	3.00 [.118]	1.25 [.050]	RBD-50-M-03
50	RG-165, RG-215, RG-213, RG-225, RG-214	5012F3332, 5012A3311	5.00-12.50 [.197-.500]	4.10-9.50 [.161-.375]	7.30 [.287]	2.45 [.100]	RBD-50-L-03
75	RG-179, RG-187	7530A1317	1.50-5.50 [.060-.217]	0.90-3.00 [.035-.118]	1.55 [.060]	0.65 [.025]	RBD-75-S-03
75	—	75 7524A1311, 7528A1317	3.50-7.00 [.138-.276]	2.10-5.00 [.083-.197]	3.70 [.146]	1.25 [.050]	RBD-75-M-03
75	RG-6, RG-11, RG-12, RG-59, RG-144, RG-216	—	5.00-12.50 [.197-.500]	4.10-9.50 [.161-.375]	7.30 [.287]	2.45 [.100]	RBD-75-L-03
BNC Straight Panel Jacks, Female Contacts							
50	RG-174, RG-178, RG-188, RG-196, RG-316	5026A1311, 5028A1317, 5030A1317	1.50-5.50 [.060-.217]	0.90-3.00 [.035-.118]	1.55 [.060]	0.65 [.025]	RBD-50-S-04
50	RG-58, RG-141, RG-142, RG-303, RG-400	5019D3318, 5021D1331, 5020A1311	3.50-7.00 [.138-.276]	2.10-5.00 [.083-.197]	3.00 [.118]	1.25 [.050]	RBD-50-M-04
50	RG-165, RG-215, RG-213, RG-225, RG-214	5012F3332, 5012A3311	5.00-12.50 [.197-.500]	4.10-9.50 [.161-.375]	7.30 [.287]	2.45 [.100]	RBD-50-L-04
75	RG-179, RG-187	7530A1317	1.50-5.50 [.060-.217]	0.90-3.00 [.035-.118]	1.55 [.060]	0.65 [.025]	RBD-75-S-04
75	—	7524A1311, 7528A1317	3.50-7.00 [.138-.276]	2.10-5.00 [.083-.197]	3.70 [.146]	1.25 [.050]	RBD-75-M-04
75	RG-6, RG-11, RG-12, RG-59, RG-144, RG-216	—	5.00-12.50 [.197-.500]	4.10-9.50 [.161-.375]	7.30 [.287]	2.45 [.100]	RBD-75-L-04

METRIC
Dimensions are millimeters over inches

Catalog 1308940
Revised 5-03
www.tycoelectronics.com

Dimensions are in millimeters and inches unless otherwise specified. Values in brackets are U.S. equivalents.

Dimensions are shown for reference purposes only. Specifications subject to change.

USA: 1-800-522-6752
Canada: 1-905-470-4425
Mexico: 01-800-733-8926
C. America: 52-55-5-729-0425

South America: 55-11-3611-1514
Japan: 81-44-900-5102
Singapore: 65-4866-151
UK: 44-1793-528171

One-Step BNC/TNC Connectors (Continued)

TNC Coaxial Connectors

Panel thickness: 3.2 [.125] max.

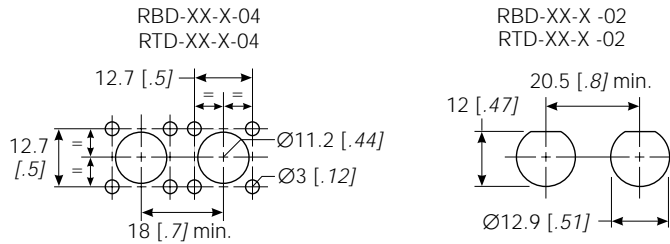

Hole Pattern for Panel-Mounted Products

Impedance (ohms)	Cable Type		Cable Dimensions				Part No.
	RG Cables	Raychem Cables	D (Min.-Max.)	E (Min.-Max.)	F (Max.)	G (Max.)	
TNC Straight Bulkhead Jacks, Female Contacts							
50	RG-174, RG-178, RG-188, RG-196, RG-316	5026A1311, 5028A1317, 5030A1317	1.50-5.50 [.060-.217]	0.90-3.00 [.035-.118]	1.55 [.060]	0.65 [.025]	RTD-50-S-02
50	RG-58, RG-141, RG-142, RG-303, RG-400	5019D3318, 5021D1331, 5020A1311	3.5-7.0 [.138-.276]	2.10-5.00 [.083-.197]	3.00 [.118]	1.25 [.050]	RTD-50-M-02
50	RG-165, RG-215, RG-213, RG-225, RG-214	5012F3332, 5012A3311	5.0-12.5 [.197-.500]	4.10-9.50 [.161-.375]	7.30 [.287]	2.45 [.100]	RTD-50-L-02
75	RG-179, RG-187	7530A1317	1.5-5.5 [.060-.217]	0.90-3.00 [.035-.118]	1.55 [.060]	0.65 [.025]	RTD-75-S-02
75	—	7524A1311, 7528A1317	3.5-7.0 [.138-.276]	2.10-5.00 [.083-.197]	3.70 [.146]	1.25 [.050]	RTD-75-M-02
75	RG-6, RG-11, RG-12, RG-59, RG-144, RG-216	—	5.0-12.5 [.197-.500]	4.10-9.50 [.161-.375]	7.30 [.287]	2.45 [.100]	RTD-75-L-02
TNC Right-Angle Plugs, Male Contacts							
50	RG-174, RG-178, RG-188, RG-196, RG-316	5026A1311, 5028A1317, 5030A1317	1.50-5.50 [.060-.217]	0.90-3.00 [.035-.118]	1.55 [.060]	0.65 [.025]	RTD-50-S-01
50	RG-58, RG-141, RG-142, RG-303, RG-400	5019D3318, 5021D1331, 5020A1311	3.50-7.00 [.138-.276]	2.10-5.00 [.083-.197]	3.00 [.118]	1.25 [.050]	RTD-50-M-01
50	RG-165, RG-215, RG-213, RG-225, RG-214	5012F3332, 5012A3311	5.00-12.50 [.197-.500]	4.10-9.50 [.161-.375]	7.30 [.287]	2.45 [.100]	RTD-50-L-01
75	RG-179, RG-187	7530A1317	1.50-5.50 [.060-.217]	0.90-3.00 [.035-.118]	1.55 [.060]	0.65 [.025]	RTD-75-S-01
75	—	7524A1311, 7528A1317	3.50-7.00 [.138-.276]	2.10-5.00 [.083-.197]	3.70 [.146]	1.25 [.050]	RTD-75-M-01
75	RG-6, RG-11, RG-12, RG-59, RG-144, RG-216	—	5.0-12.5 [.197-.500]	4.10-9.50 [.161-.375]	7.30 [.287]	2.45 [.100]	RTD-75-L-01

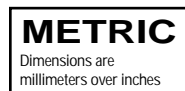

TNC Coaxial Connectors

Impedance (ohms)	Cable Type		Cable Dimensions				Part No.
	RG Cables	Raychem Cables	D (Min.-Max.)	E (Min.-Max.)	F (Max.)	G (Max.)	
TNC Straight Plugs, Male Contacts							
50	RG-174, RG-178, RG-188, RG-196, RG-316	5026A1311, 5028A1317, 5030A1317	1.50-5.50 [.060-.217]	0.90-3.00 [.035-.118]	1.55 [.060]	0.65 [.025]	RTD-50-S-00
50	RG-58, RG-141, RG-142, RG-303, RG-400	5019D3318, 5021D1331, 5020A1311	3.50-7.00 [.138-.276]	2.10-5.00 [.083-.197]	3.00 [.118]	1.25 [.050]	RTD-50-M-00
50	RG-165, RG-215, RG-213, RG-225, RG-214	5012F3332, 5012A3311	5.00-12.50 [.197-.500]	4.10-9.50 [.161-.375]	7.30 [.287]	2.45 [.100]	RTD-50-L-00
75	RG-179, RG-187	7530A1317	1.50-5.50 [.060-.217]	0.90-3.00 [.035-.118]	1.55 [.060]	0.65 [.025]	RTD-75-S-00
75	—	7524A1311, 7528A1317	3.50-7.00 [.138-.276]	2.10-5.00 [.083-.197]	3.70 [.146]	1.25 [.050]	RTD-75-M-00
75	RG-6, RG-11, RG-12, RG-59, RG-144, RG-216	—	5.00-12.50 [.197-.500]	4.10-9.50 [.161-.375]	7.30 [.287]	2.45 [.100]	RTD-75-L-00
TNC Straight Jacks, Female Contacts							
50	RG-174, RG-178, RG-188, RG-196, RG-316	5026A1311, 5028A1317, 5030A1317	1.5-5.5 [.060-.217]	0.9-3.0 [.035-.118]	1.55 [.060]	0.65 [.025]	RTD-50-S-03
50	RG-58, RG-141, RG-142, RG-303, RG-400	5019D3318, 5021D1331, 5020A1311	3.5-7.0 [.138-.276]	2.1-5.0 [.083-.197]	3.0 [.118]	1.25 [.050]	RTD-50-M-03
50	RG-165, RG-215, RG-213, RG-225, RG-214	5012F3332, 5012A3311	5.0-12.5 [.197-.500]	4.1-9.5 [.161-.375]	7.3 [.287]	2.45 [.100]	RTD-50-L-03
75	RG-179, RG-187	7530A1317	1.5-5.5 [.060-.217]	0.9-3.0 [.035-.118]	1.55 [.060]	0.65 [.025]	RTD-75-S-03
75	—	7524A1311, 7528A1317	3.5-7.0 [.138-.276]	2.1-5.0 [.083-.197]	3.7 [.146]	1.25 [.050]	RTD-75-M-03
75	RG-6, RG-11, RG-12, RG-59, RG-144, RG-216	—	5.0-12.5 [.197-.500]	4.1-9.5 [.161-.375]	7.3 [.287]	2.45 [.100]	RTD-75-L-03
TNC Straight Panel Jacks, Female Contacts							
50	RG-174, RG-178, RG-188, RG-196, RG-316	5026A1311, 5028A1317, 5030A1317	1.5-5.5 [.060-.217]	0.9-3.0 [.035-.118]	1.55 [.060]	0.65 [.025]	RTD-50-S-04
50	RG-58, RG-141, RG-142, RG-303, RG-400	5019D3318, 5021D1331, 5020A1311	3.5-7.0 [.138-.276]	2.1-5.0 [.083-.197]	3.0 [.118]	1.25 [.050]	RTD-50-M-04
50	RG-165, RG-215, RG-213, RG-225, RG-214	5012F3332, 5012A3311	5.0-12.5 [.197-.500]	4.1-9.5 [.161-.375]	7.3 [.287]	2.45 [.100]	RTD-50-L-04
75	RG-179, RG-187	7530A1317	1.5-5.5 [.060-.217]	0.9-3.0 [.035-.118]	1.55 [.060]	0.65 [.025]	RTD-75-S-04
75	—	7524A1311, 7528A1317	3.5-7.0 [.138-.276]	2.1-5.0 [.083-.197]	3.7 [.146]	1.25 [.050]	RTD-75-M-04
75	RG-6, RG-11, RG-12, RG-59, RG-144, RG-216	—	5.0-12.5 [.197-.500]	4.1-9.5 [.161-.375]	7.3 [.287]	2.45 [.100]	RTD-75-L-04

METRIC
Dimensions are millimeters over inches

Features

- Intermateable with Gilbert GPO™ Series
- Enhanced performance features
- Simplified Assembly

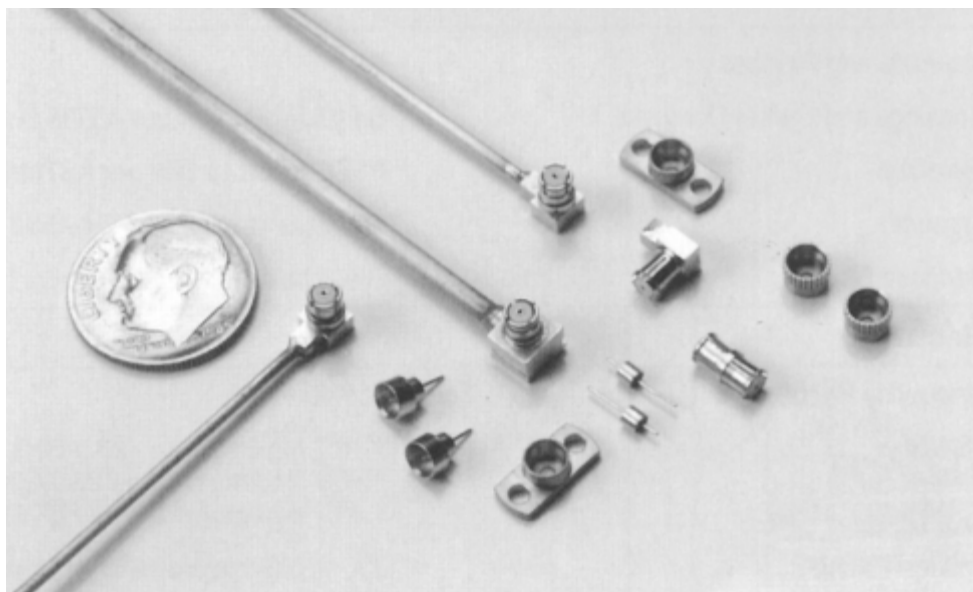

OSMP microminiature push-on coaxial connectors provide solutions for today's modular designs with denser packaging requirements. The extremely small size of the OSMP offers a versatile solution for high density packaging allowing connector center-to-center spacing of 0.17 [4.32]. The push-on interface facilitates easier assembly and test with a positive snap-in feature to indicate a fully mated connection. The rugged OSMP interface can better withstand harsh environments of mechanical shock and vibration, typically found in military or aerospace related applications. This OSMP connector interface is the standard used by Defense Electronics Supply Center (DSCC) to generate the SMP push-on connector series.

OSMP connectors can be your design solution for mechanical packaging and frequency response. The OSMP interface provides 0.020" of radial misalignment for critical blindmate applications. Mating forces are strictly controlled for reliable connections per mated pair or when simultaneously mating multiple connectors. Cable jacks include an anti-rocking ring for reliable mechanical performance for harsh operating environments. OSMP connectors offer enhanced broadband VSWR performance of

1.15:1 max thru 26GHz and 1.40:1 max thru 40GHz.

Standard design OSMP configurations include cable connectors, straight and right-angle, for 0.047 and 0.085 semi-rigid cable, full detent, limited detent and smooth bore mating shrouds that can be bulk-head or flange mounted and glass feedthroughs for coax to circuit launchers. In-series adapters for module-to-module intermating and between series adapters for integrating or testing systems or components parameters.

Between Series Adapters

For OSMP Between Series Adapters, see page 7044.

OSMP Shroud and Jack-to-Jack Adapter Assembly

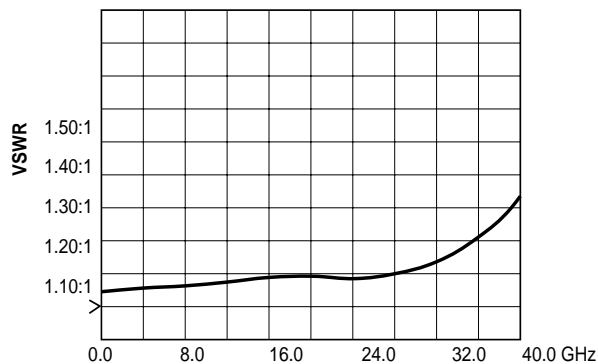
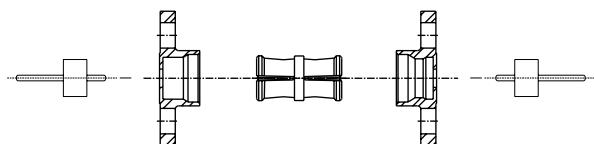

**Typical VSWR for OSMP Jack-to-Jack Adapter
Part Numbers 1059829-1 and 1056721-1**

Specifications

General	
Materials and Finishes	
Housings and Center Contacts	Beryllium Copper per ASTM-B-196; gold plate over nickel plate
Dielectric	PTFE Fluorocarbon per ASTM-D-1457
Shrouds	Stainless steel per ASTM-A582 Type 303; passivate per ASTM-A380
Hermetic Seal	Glass bead
Electrical	
Frequency Range	dc - 40.0 GHz
VSWR	1.10:1 Maximum dc - 23.0 GHz 1.15:1 Maximum 23.0 - 26.0 GHz 1.40:1 Maximum 26.0 - 40.0 GHz
Voltage Rating	335 Vrms maximum at sea level
Insertion Loss	0.10 \sqrt{f} (GHz) maximum
Insulation Resistance	5000 megohms minimum
Dielectric Withstanding Voltage	500 volts (VRMS minimum)
RF High Potential	325 volts (VRMS minimum) @ 5 MHz
Impedance	50 ohms nominal
RF Leakage	-80dB to 3 GHz, -65dB from 3 to 26.5 dB minimum
Contact Resistance	Initial center contact 6.0 milliohms maximum Outer contact 2.0 milliohms maximum
Mechanical	
Durability	100 mating cycles minimum
Radial Misalignment	± 0.020 minimum
Axial Misalignment	.000/.010
Force to Engage	full detent 15.0 lbs. maximum half detent 10.0 lbs. maximum smooth bore 2.0 lbs. maximum
Force to Disengage	full detent 5.0 lbs. minimum half detent 2.0 lbs. minimum smooth bore 0.5 lbs. minimum
Center Contact Retention	1.5 lbs. minimum axial force
Environmental	
Operating Temperature	-85°F to +329°F [-65°C to +165°C]
Vibration	per mil-std-202, method 204, test condition D
Shock	per mil-std-202, method 213, test condition I
Thermal Shock	per mil-std-202, method 107, test condition B
Moisture Resistance	per MIL-STD-202 method 106, except step 7b shall be omitted. Resistance shall be 200 megohms within 5 minutes after removal from humidity.

Interface Dimensions

Jack

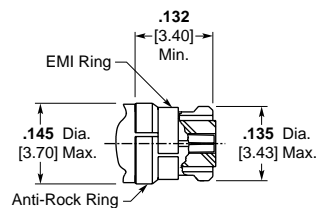

Shroud

Full Detent

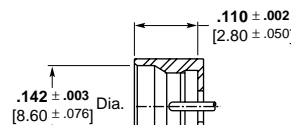

Bullet

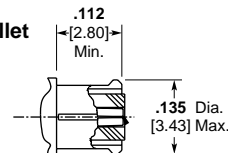

Smooth Bore

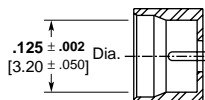

Note: The U.S. Government (DSCC) has determined that the above specified interface dimensions are interchangeable and intermateable with Gilbert GPO Series RF Connectors.

Jacks

Straight Cable Jack, Solder
Attachment

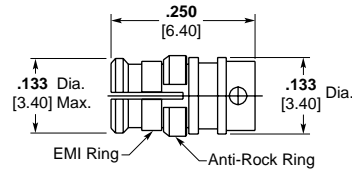

Cable	M/A-COM Part No. (Ref. only)	Part No.
.047 Semi-Rigid	2902-7947-62	1056526-1
.085 Semi-Rigid (RG-405)	2902-7985-62	1056527-1

Right-Angle Cable
Jack, Solder Attachment

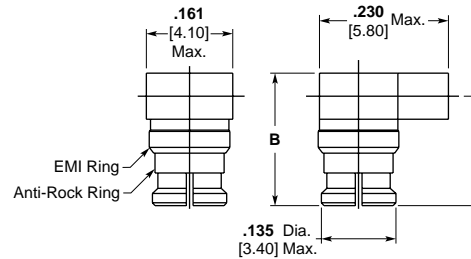

Cable	Dim. A	Dim. B	M/A-COM Part No. (Ref. only)	Part No.
.047 Semi-Rigid	.190 4.80	.230 5.80	2908-7947-62	1056553-1
.085 Semi-Rigid (RG-405)	.209 5.30	.265 6.70	2908-7985-62	1056554-1

Jack to Jack Adapter (Bullet)

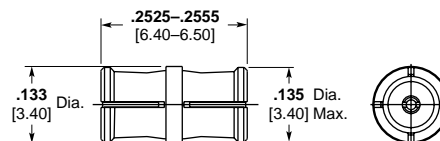

M/A-COM Part No. (Ref. only)	Part No.
2980-0000-62	1059829-1

Shrouds

Shroud — Threaded

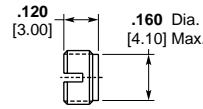

Description	M/A-COM Part No. (Ref. only)	Part No.
Full Detent	2998-5045-02	1056745-1
Limited Detent	2998-5043-02	1056743-1
Smooth Bore	2998-5044-02	1056744-1

Shroud — 2 Hole Flange
Surface Mount

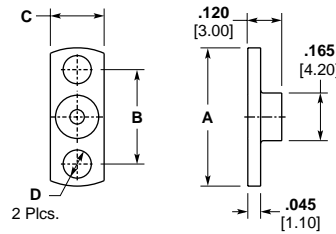

Description	Dim. A	Dim. B	Dim. C	Dim. D	M/A-COM Part No. (Ref. only)	Part No.
Full Detent	.480 12.20	.328 8.30	.187 4.70	.098 2.50	2998-5001-02	1056721-1
	.625 15.80	.481 12.20	.223 5.70	.102 2.60	2998-5002-02	1056722-1
Limited Detent	.400 10.20	.282 7.20	.165 4.20	.073 1.90	2998-5003-02	1056724-1
	.480 12.20	.328 8.30	.187 4.70	.098 2.50	2998-5028-02	1056729-1
Smooth Bore	.400 10.20	.282 7.20	.165 4.20	.073 1.90	2998-5030-02	1056731-1
	.400 10.20	.282 7.20	.165 4.20	.073 1.90	2998-5049-02	1056749-1

Shroud — Press Fit

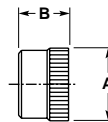

Description	Dim. A	Dim. B	M/A-COM Part No. (Ref. only)	Part No.
Full Detent	.182 4.60	.115 2.90	2998-5005-02	1056726-1
Limited Detent	.174 4.40	.120 3.00	2998-5033-02	1056734-1
	.154 3.90	.080 2.00	2998-5035-02	1056736-1

Shrouds (Continued)

Shroud — Solder-In
Hermetic

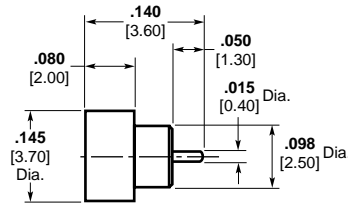

Description	M/A-COM Part No. (Ref. only)	Part No.
Full Detent	2998-5054-94	1056750-1
Limited Detent	2998-5055-94	1056751-1
Smooth Bore	2998-5056-94	1056752-1

Glass Bead Assembly

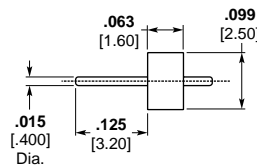

M/A-COM Part No. (Ref. only)	Part No.
2998-5022-94	1056728-1

Between Series Adapters

Between Series Coaxial Transmission Line Adapters provide convenient transitions between popular series coaxial connectors. The adapter design provides a minimum length consistent with good electrical performance. The small size, low VSWR, and broad frequency coverage permits a wide range of applications in both measurement and systems use.

SMA Plug – OSMP Plug

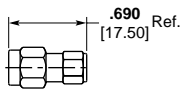

Part Number 1056706-1
M/A-COM Part No. (Ref. only)
2981-2241-00

SMA Jack – OSMP Jack

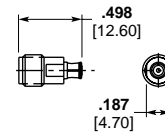

Part Number 1056702-1
M/A-COM Part No. (Ref. only)
2980-2240-00

SMA Jack – OSMP Plug

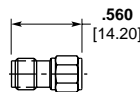

Part Number 1056707-1
M/A-COM Part No. (Ref. only)
2982-2240-00

OSMP Jack – SMA Plug

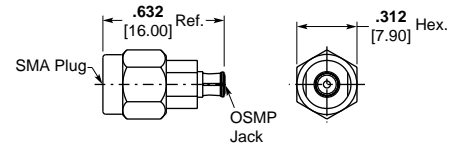

Part Number 1056708-1
M/A-COM Part No. (Ref. only)
2982-2241-00

Introduction

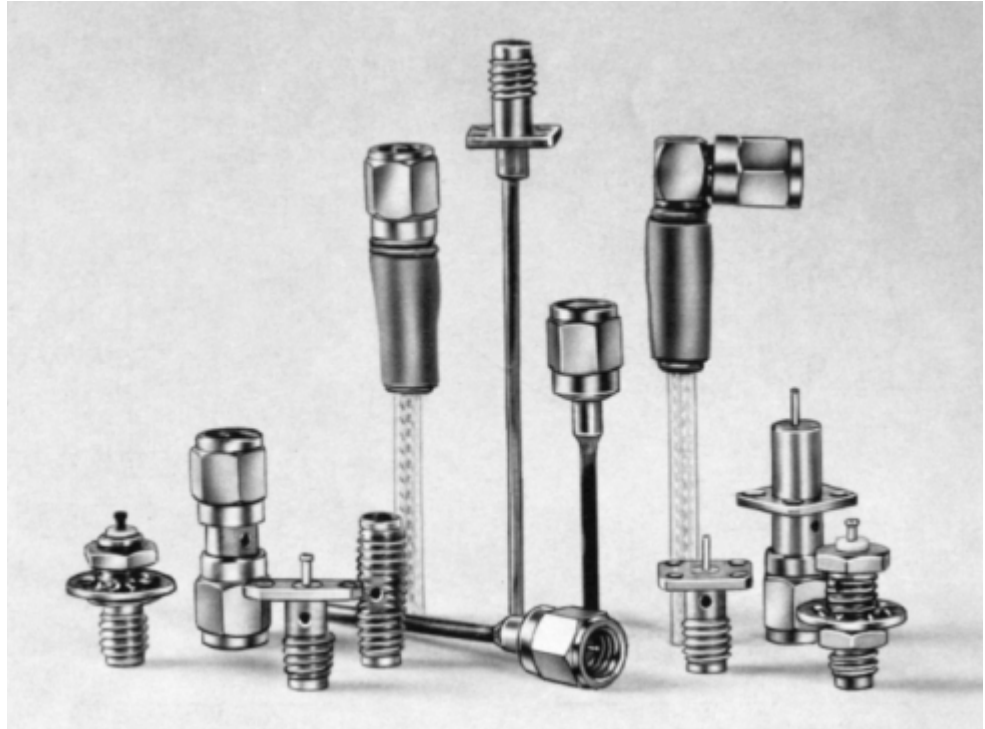

The microminiature series has been developed to meet the increasing demand for smaller connector size. This series is small, but still very rugged for its relative size.

The interface mating design insures precise outer shell alignment before engagement of the inner contacts. The OSMM Series is compatible with smaller diameter semi-rigid cable.

Design and Construction

All shell and body parts are made of stainless steel for ruggedness and long life. The dielectric is PTFE fluorocarbon. The center contacts are made of beryllium copper, gold plated. The coupling thread is .138-40 UNF thread.

Types

The OSMM Series connectors are available for appro-

priate size semi-rigid and flexible coaxial cables. Panel and bulkhead mount are also available to provide complete flexibility to component and system design.

Application

Typical applications include requirements from low RF to high microwave frequencies. The higher order moding for this series is above 45.0 GHz, but the primary feature is the microminiature size.

Interface Mating Dimensions

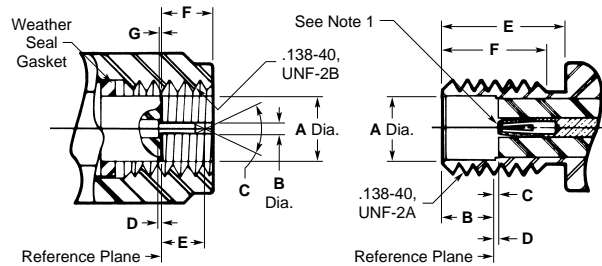

Plug

Dim.	Min.	Max.
A	.0930 2.36	.0946 2.43
B	.0150 0.38	.0163 0.42
C	60°	90°
D	.000 0.00	.010 0.25
E	.055 1.40	.070 1.78
F	.065 1.65	.099 2.29
G	.000 0.00	.010 0.25

Jack

Dim.	Min.	Max.
A	.096 2.44	.097 2.46
B	.076 1.98	.082 2.08
C	.000 0.00	.010 0.25
D	.000 0.00	.010 0.25
E	.175 4.45	—
F	.140 3.56	—

1. ID to meet VSWR and contact resistance when mated with .0155 +.0008/-.0005 [0.0394 +.0203/-.0127] dia. pin.
2. When fully engaged, the two reference planes must coincide with metal to metal contact.

Specifications

Requirement	MIL-C-39012 Applicable Paragraph	Detail
General		
Material	3.3	Steel corrosion resistant per ASTM-A-582 and ASTM-A-484, Type 303. Beryllium copper per ASTM B 196. PTFE Fluorocarbon per ASTM-D-1457.
Finish	3.31	Center contacts shall be gold plated to a min. thickness of .00005 [0.0013] in accordance with MIL-G-45204, Typ I, Grade C. All other metal parts shall be finished as to provide a connector which meets the corrosion requirements.
Design	3.4	The design shall be such that the outline shown in this catalog and the interface dimensions of MIL-STD-348A are met.
Electrical		
Insulation Resistance	3.11	The insulation resistance shall not be less than 5,000 megohms.
Corona Level	3.22	The connector shall not exhibit breakdown when the voltage is 150 volts rms at 70,000 ft.
Dielectric Withstanding Voltage	3.17	The magnitude of the test voltage shall be 500 volts rms at sea level.
RF High Potential	3.23	The withstanding voltage is 375 volts rms at 5 MHz. Leakage current is not applicable.
Contact Resistance	3.16	Center contact resistance: 3.5 milliohms max. Outer contact resistance: 2.8 milliohms max.
VSWR	3.14	No military slash sheet applies. Consult factory. Frequency range dependent on cable used.
RF Leakage	3.26	No military slash sheet applies. Consult factory.
Insertion Loss	3.27	No military slash sheet applies. Consult factory. Frequency range dependent on cable used.
Mechanical		
Force to Engage	3.5.1	The torque required to engage and disengage shall not exceed 1 in.-lbs. The longitudinal force is not applicable.
Coupling Nut Retention	3.25	40 lbs. min. Applicable for plug connectors only.
Coupling Proof Torque	3.6	4 in.-lbs. min. Applicable for plug connectors only.
Cable Retention	3.24	No military slash sheet applies. Consult factory.
Mating Characteristics	3.7	Applicable to jack connectors only. Oversize pin .0165 [0.419] min. dia., .045 [1.14] deep; insertion force 3 lbs. max. with .0163 [0.414] min. dia. pin; withdrawal force 0.5 oz. min. with .015 [0.38] max. dia. pin.
Connector Durability	3.15	The connector to be tested and its mating connector shall be subjected to 500 insertion and withdrawal cycles at 12 cycles per minute max. The connector shall show no evidence of mechanical failure and shall meet the mating characteristic requirements.
Recommended Mating Torque	—	2 in.-lbs.
Environmental		
Vibration	3.18	Specification MIL-STD-202, method 204, test condition D.
Shock	3.19	Specification MIL-STD-202, method 213, test condition I.
Thermal Shock	3.20	No military slash sheet applies. Consult factory.
Corrosion (Salt Spray)	3.13	Specification MIL-STD-202, method 101, test condition B.
Moisture Resistance	3.21	Specification MIL-STD-202, method 106. No measurements at high humidity. Insulation resistance shall be at least 200 megohms within 5 minutes of removal from humidity.

For Flexible and Semi-Rigid Cables

Straight Cable Plug

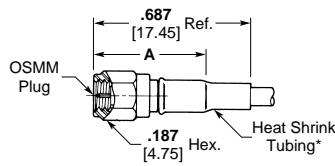

Cable	Attachment	Dim. A	M/A-COM Part No. (Ref. only)	Part Number
RG 196/U Flexible	Crimp	.450 11.40 Ref.	4031-7196-00	1059057-1
.047 Dia.* Semi-Rigid	Direct Solder	.360 9.20 Ref.	4001-7947-00	1058955-1

* Semi-rigid versions do not use heat shrink tubing.
Finish: Gold plate.

Straight Cable Jack

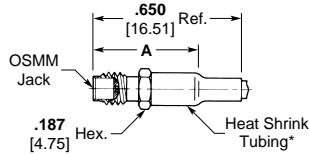

Cable	Attachment	Dim. A	M/A-COM Part No. (Ref. only)	Part Number
.047 Dia.* Semi-Rigid	Direct Solder	.330 8.40 Ref.	4002-7947-00	1058958-1

* Semi-rigid versions do not use heat shrink tubing.
Finish: Gold plate.

Bulkhead Feedthrough Cable Jack

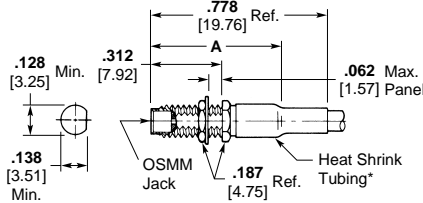

Recommended Mounting Hole

Cable	Attachment	Dim. A	M/A-Com Part No. (Ref. only)	Part Number
RG 196/U Flexible	Crimp	.565 14.40 Ref.	4034-7196-00	1059060-1
.047 Dia.* Semi-Rigid	Direct Solder	.458 11.60 Ref.	4004-7947-00	1058990-1

* Semi-rigid versions do not use heat shrink tubing.
Finish: Gold plate.

Right-Angle Cable Plug

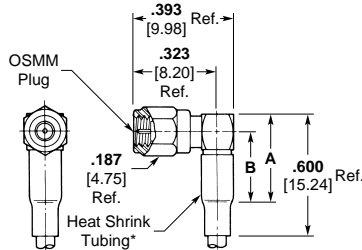

Cable	Attachment	Dim. A	Dim. B	M/A-Com Part No. (Ref. only)	Part Number
.047 Dia.* Semi-Rigid	Direct Solder	.256 6.50 Ref.	.178 4.50 Ref.	4007-7947-00	1058993-1

* Semi-rigid versions do not use heat shrink tubing.
Finish: Gold plate.

Bulkhead Feedthrough Jack

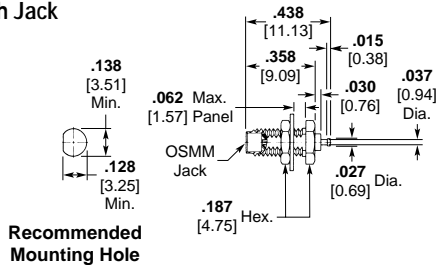

Recommended Mounting Hole

Description	M/A-COM Part No. (Ref. only)	Part Number
Captured Center Contact* Turret Terminal Rear Mount	4056-0000-00	1059073-1

* Contact captivation per U.S. patent number 3,292,117.
Finish: Gold plate.

Printed Circuit Board Straight Jack

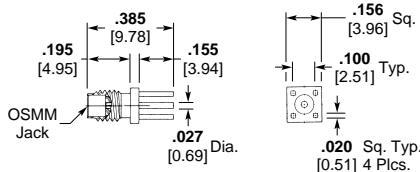

Description	M/A-COM Part No. (Ref. only)	Part Number
Captured Center Contact* Straight Terminal	4062-0000-00	1059081-1

* Contact captivation per U.S. patent number 3,292,117.
Finish: Gold plate.

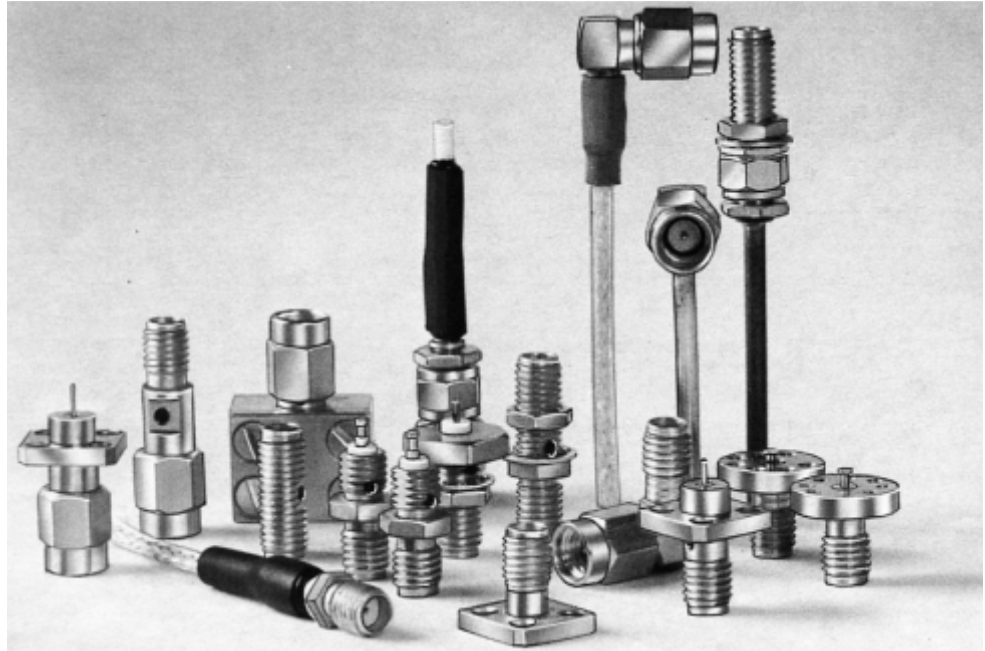
Introduction

The success of the SMA connector created a need for a smaller version for reduced packaging requirements. The SSMA series was designed to a size compatible with smaller diameter semi-rigid cable. The coupling thread is 10-36 UNS thread.

Design and Construction

As with the SMA series, all shell and body parts are made of stainless steel for ruggedness and long life. The dielectric is solid PTFE fluorocarbon. The center contacts are made of beryllium copper, gold plated.

Types

SSMA connectors are available for both semi-rigid and flexible coaxial cable. Panel and bulkhead mount, strip transmission line type, microstrip transmission type and hermetically sealed connectors and in-series adapters give designers complete flexibility for component and system design.

Upper Operating Frequency Limits

The standard SSMA series allows operation to 38.0 GHz. The extended frequency SSMA series allows high order mode free operation beyond 40.0 GHz. The extended frequency series directly mates with the standard SSMA series with minimum discontinuity.

Interface Mating Dimensions

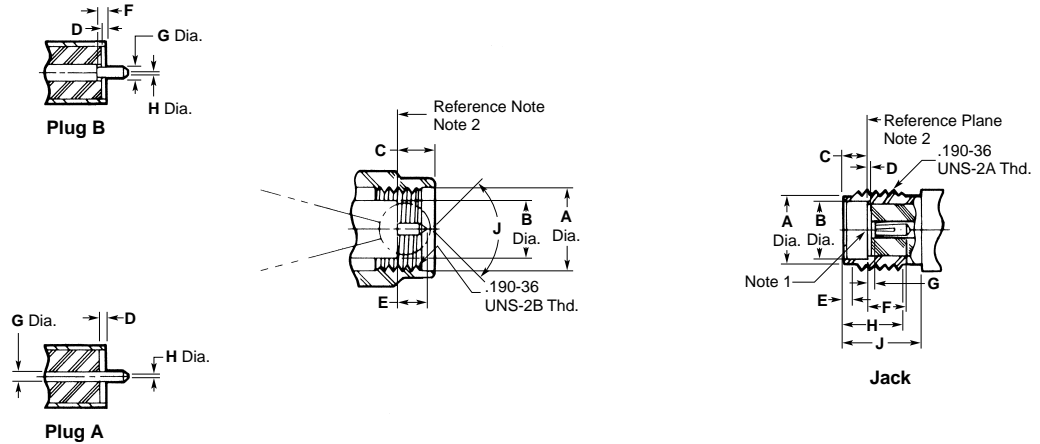

Plug

Dim.	Min.	Max.
A	.196 4.98	.202 5.13
B	.124 3.15	.127 3.22
C	.100 2.54	.133 3.38
D	.000 0.00	.007 0.25
E	.050 1.27	.065 1.65
F	.000 0.00	.010 0.25
G	.020 0.50	.021 0.53
H	.000 0.00	.010 0.25
J	70°	95°

Jack

Dim.	Min.	Max.
A	.153 3.89	.160 4.06
B	.127 3.23	.130 3.30
C	.075 1.91	.077 1.96
D	.000 0.00	.007 0.25
E	.020 0.51	.040 1.02
F	.075 1.91	—
G	.000 0.00	.010 0.25
H	.190 4.83	.210 5.33
J	.230 5.84	—

1. ID to meet VSWR and contact resistance when mated with .020 +.0008/-.0005 [0.51 +.0203/-.0127] dia. pin.
2. When fully engaged, the two reference planes must coincide with metal to metal contact.

Specifications

General	
Materials	Steel corrosion resistant per ASTM-A-582 and ASTM-A-484, Type 303. Beryllium copper per ASTM B 196. PTFE Fluorocarbon per ASTM-D-1457.
Finishes	Center contacts shall be gold plated to a min. thickness of .00005 [0.0013] in accordance with MIL-G-45204, Typ I, Grade C. All other metal parts shall be finished as to provide a connector which meets the corrosion requirements.
Design	The design shall be such that the outline shown in this catalog and the interface dimensions of MIL-STD-348A are met.
Electrical	
Insulation Resistance	The insulation resistance shall not be less than 5,000 megohms.
Corona Level	The connector shall not exhibit breakdown when the voltage is 190 volts rms at 70,000 ft.
Dielectric Withstanding Voltage	The magnitude of the test voltage shall be 750 volts rms at sea level.
RF High Potential	The withstanding voltage is 500 volts rms at 5 MHz. Leakage current is not applicable.
Contact Resistance	Center contact resistance: 2 milliohms max. Outer contact resistance: 2 milliohms max.
VSWR	Refer to applicable military slash sheet or consult factory. Frequency range dependent on cable used.
RF Leakage	Refer to applicable military slash sheet or consult factory.
Insertion Loss	Refer to applicable military slash sheet or consult factory. Frequency range dependent on cable use.
Mechanical	
Force to Engage	The torque required to engage and disengage shall not exceed 2 in.-lbs. The longitudinal force is not applicable.
Coupling Nut Retention	60 lbs. min. Applicable for plug connectors only.
Coupling Proof Torque	5 in.-lbs. min. Applicable for plug connectors only.
Cable Retention	Refer to applicable military slash sheet or consult factory.
Mating Characteristics	Applicable to jack connectors only. Reference MIL-STD-348A for dimensions; oversize pin .021 [0.53] min. dia., .045 [1.14] deep; insertion force 3 lbs. max. with .0208 [0.528] min. dia. pin; withdrawal force 1 oz. min. with .0195 [0.495] max. dia. pin.
Connector Durability	The connector to be tested and its mating connector shall be subjected to 500 insertion and withdrawal cycles at 12 cycles per minute max. The connector shall show no evidence of mechanical failure and shall meet the mating characteristic requirements.
Recommended Mating Torque	5 in.-lbs.
Environmental	
Vibration	Specification MIL-STD-202, method 204, test condition D.
Shock	Specification MIL-STD-202, method 213, test condition I.
Thermal Shock	Refer to applicable military slash sheet or consult factory.
Corrosion (Salt Spray)	Specification MIL-STD-202, method 101, test condition B.
Moisture Resistance	Specification MIL-STD-202, method 106. No measurements at high humidity. Insulation resistance shall be at least 200 megohms within 5 minutes of removal from humidity.

For Semi-Rigid Cable

.085 [2.16] Dia. Direct Solder Attachment

Straight Cable Plug (Without Center Contact)

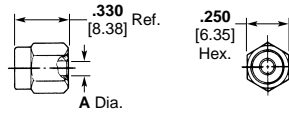

M/A-COM Part No. (Ref. Only)	AMP Part No.	Dim. A	RG/U Cable	Cable Dielectric
1001-7985-02	1045370-1	.088 Min. 2.22	405	Solid PTFE

Electrical
DC — 40.0 GHz

Straight Cable Plug (With Center Contact)

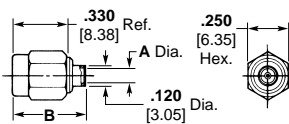

M/A-COM Part No. (Ref. Only)	AMP Part No.	Dim. A	Dim. B	RG/U Cable	Cable Dielectric
1001-5004-02	1045351-1	.088 Min. 2.22	.447 Ref. 11.35	405	Solid PTFE

Straight Cable Jack (With Center Contact)

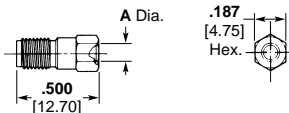

M/A-COM Part No. (Ref. Only)	AMP Part No.	Dim. A	RG/U Cable	Cable Dielectric
1002-7985-00	1045381-1	.088 Min. 2.22	405	Solid PTFE

Bulkhead Feed-through Cable Jack

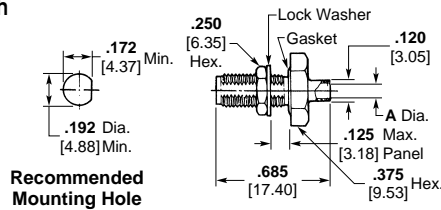

Recommended Mounting Hole

M/A-COM Part No. (Ref. Only)	AMP Part No.	Dim. A	RG/U Cable	Cable Dielectric
1004-7985-00	1045401-1	.088 Min. 2.22	405	Solid PTFE

Flange Mount Cable Jack

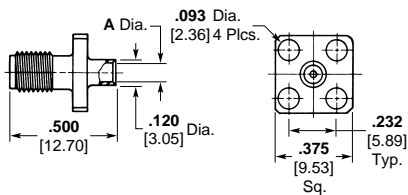

M/A-COM Part No. (Ref. Only)	AMP Part No.	Dim. A	RG/U Cable	Cable Dielectric
1006-7985-00	1045410-1	.088 Min. 2.22	405	Solid PTFE

Right-Angle Cable Plug

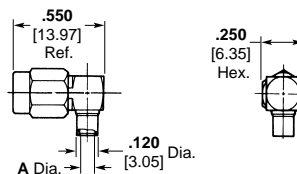

M/A-COM Part No. (Ref. Only)	AMP Part No.	Dim. A	RG/U Cable	Cable Dielectric
1007-7985-02	1045423-1	.088 Min. 2.22	405	Solid PTFE

Finish: Passivated stainless steel, -02. For gold plated coupling nut, change the Part Number suffix from -02 to -00.
Inner housing that is soldered to cable is gold plated.
Refer to recommended assembly tools in Application Tooling Section.

Flexible Cable — Solder Attachment

Straight Cable Plug^{1,3}

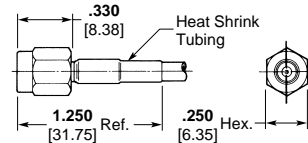

M/A-COM Part No. (Ref. Only)	AMP Part No.	RG/U Cable
1031-5001-02	1045477-1	178/U, 196
1031-5002-02	1045482-1	174/U, 179, 187, 188, 316

Straight Cable Jack³

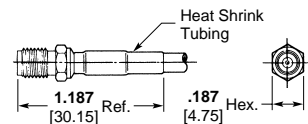

M/A-COM Part No. (Ref. Only)	AMP Part No.	RG/U Cable
1032-5001-00	1045496-1	178/U, 196
1032-5002-00	1045497-1	174/U, 179, 187, 188, 316

Finish: Gold plated. Inner housing that is soldered to cable is gold plated.

Right-Angle Cable Plug¹

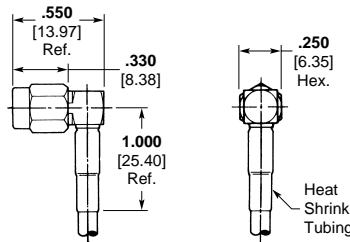

M/A-COM Part No. (Ref. Only)	AMP Part No.	RG/U Cable
1037-5001-02	1045508-1	178/U, 196
1037-5002-02	1045511-1	174/U, 179, 187, 188, 316

Flexible Cable — Crimp Attachment

Straight Cable Plug^{1,2}

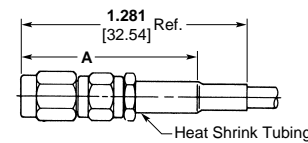

M/A-COM Part No. (Ref. Only)	AMP Part No.	Dim. A	RG/U Cable
1031-7188-02	1045489-1	1.062 Ref. 26.97	174/U, 179, 187, 188, 316

Bulkhead Feed-through Cable Jack^{1,2}

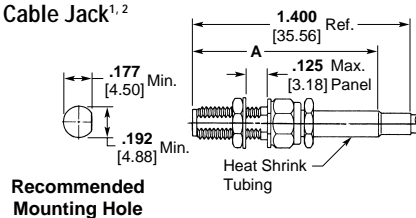

M/A-COM Part No. (Ref. Only)	AMP Part No.	Dim. A	RG/U Cable
1034-7196-02	1045506-1	1.050 Ref. 26.67	178/U, 196
1034-7188-02	1045503-1	1.180 Ref. 29.97	174/U, 179, 187, 188, 316

Right-Angle Cable Plug^{1,2}

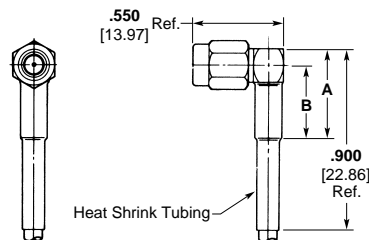

M/A-COM Part No. (Ref. Only)	AMP Part No.	Dim. A	Dim. B	RG/U Cable
1037-7188-02	1045520-1	.625 Ref. 15.88	.525 Ref. 13.34	174/U, 179, 187, 188, 316

Refer to recommended assembly tools in Application Tooling Section.

1. Finish: Passivated stainless steel, -02. For gold plated coupling nut, change the Part Number suffix from -02 to -00. Inner housing that is soldered to cable is gold plated.
2. Captured contact.
3. Non-captured contact

Panel Mount Receptacles

Solder Pot Terminals
Flange Mount Jack Receptacle¹

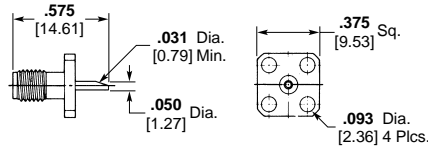

M/A-COM Part No. (Ref. Only)	AMP Part No.
1052-0000-00	1045568-1

Flange Mount Jack Receptacle¹

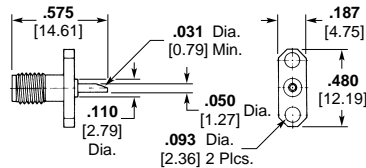

M/A-COM Part No. (Ref. Only)	AMP Part No.
1052-1300-02	1045582-1

Flange Mount Jack Receptacle¹

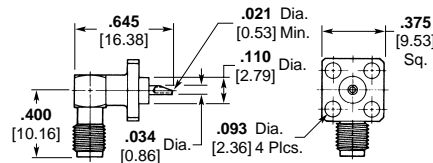

M/A-COM Part No. (Ref. Only)	AMP Part No.
1054-5005-02	1045621-1

Bulkhead Mount Receptacles

Solder Pot Terminals
Bulkhead Feed-through Jack Receptacles¹

Rear Mount

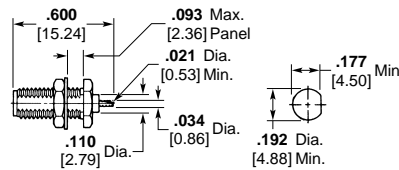

Recommended Mounting Hole

M/A-COM Part No. (Ref. Only)	AMP Part No.
1056-0000-02	1045630-1

Rear Mount (With "O" Ring)

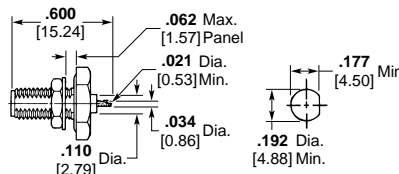

Recommended Mounting Hole

M/A-COM Part No. (Ref. Only)	AMP Part No.
1056-1100-02	1045632-1

Turret Terminal
Bulkhead Feed-through Jack Receptacle¹

Front Mount

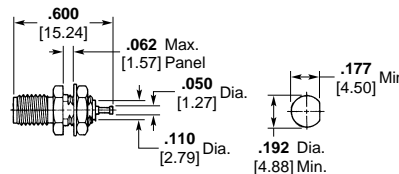

Recommended Mounting Hole

M/A-COM Part No. (Ref. Only)	AMP Part No.
1058-0000-02	1045637-1

Finish: Passivated stainless steel, -02. For gold plate, change the Part Number suffix from -02 to -00.
1. Captured Center Contact.

Panel Mount Receptacles

**Straight Terminal
Flange Mount Jack
Receptacle²**

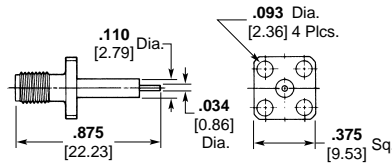

M/A-COM Part No. (Ref. Only)	AMP Part No.
1052-1200-12	1045576-1
1052-1201-02	1045578-1

**Tab Terminal
Flange Mount Jack
Receptacle²**

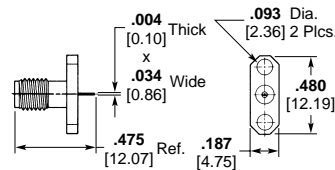

M/A-COM Part No. (Ref. Only)	AMP Part No.
1052-1302-02	1045586-1

Printed Circuit Boards

Straight Jack

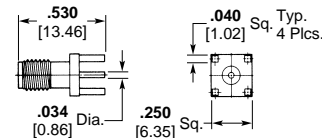

M/A-COM Part No. (Ref. Only)	AMP Part No.
1062-0000-00	1045672-1

Finish: Gold plate.

Right-Angle Jack

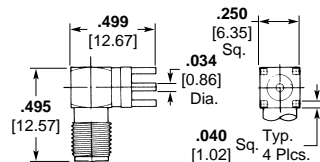

M/A-COM Part No. (Ref. Only)	AMP Part No.
1064-0000-00	1045677-1

Circuits

**Microstrip Transmission
Line Circuits, Flange
Mount Jack¹**

Tab Terminal

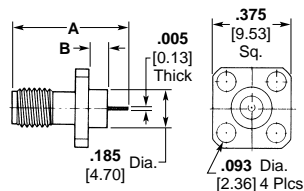

M/A-COM Part No. (Ref. Only)	AMP Part No.	Dim. A	Dim. B
1052-1132-00	1045573-1	.600 15.24 Ref.	.125 3.18 Ref.

**Solderless Compression
Terminal**

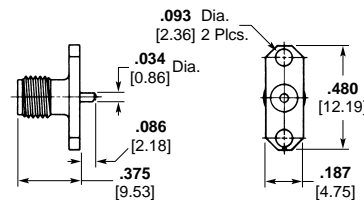

M/A-COM Part No. (Ref. Only)	AMP Part No.
1052-5013-00	1045607-1

Finish: Passivated stainless steel, -02. For gold plate, change the Part Number suffix from -02 to -00.
 1. Captured center contact.
 2. Non-captured center contact.

Hermetically Sealed

Metal-To-Metal Hermetic Seal

Jack Receptacle With EMI/RFI Gasket, Field Replaceable Solder and Braze-In^{1,4}

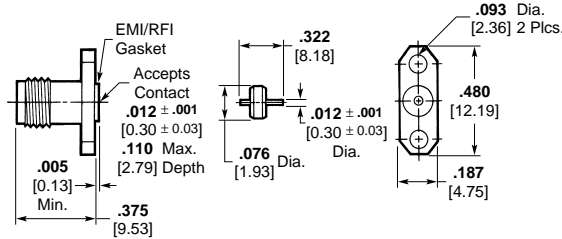
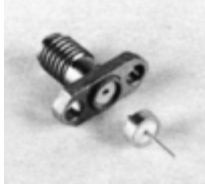

M/A-COM Part No. (Ref. Only)	AMP Part No.
1052-3355-02	1045598-1

Electrical

VSWR (GHz) — 1.07 + .011f
RF Leakage (dB) — -(100 - fGHz)

Feed-through Jack Receptacle, Formable Gasket^{2,4}

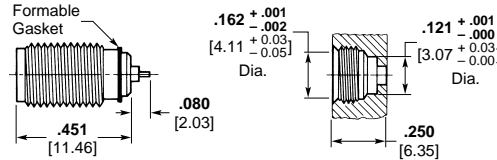

M/A-COM Part No. (Ref. Only)	AMP Part No.
1058-5014-00	1045651-1

Electrical

VSWR (GHz) — 1.05 + .01f
RF Leakage (dB) — -(100 - fGHz)

Mechanical

Installation Thermal Limit — 250°C

Recommended Mounting Hole

Feed-through Jack Receptacle, Solder and Braze-In³

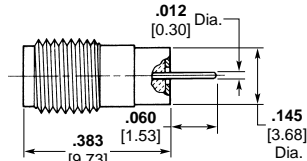

M/A-COM Part No. (Ref. Only)	AMP Part No.
1058-3203-00	1045647-1

Electrical

VSWR (GHz) — 1.05 + .014f
RF Leakage (dB) — -(100 - fGHz)

Panel Feed-through Jack Receptacle, Solder and Braze-In

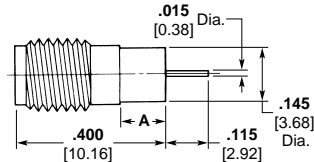

M/A-COM Part No. (Ref. Only)	AMP Part No.	Dim. A
1058-3121-00	1045643-1	.093 2.36
1058-3122-00	1045645-1	.125 3.18
1058-3123-00	1045646-1	.187 4.75

Finish: Gold plate.

Electrical

VSWR (GHz) — 1.05 + .014f
RF Leakage (dB) — -(70 - fGHz)

1. Finish: Passivated stainless steel, -02. For gold plate, change the Part Number suffix from -02 to -00.
2. Finish: Gold plate, -00. For passivated stainless steel, change the Part Number suffix from -00 to -02. For nickel plate, change the suffix from -00 to -10.
3. Finish: Gold plate, -00. This unit has a unique self-matching compensation step, allowing direct attachment to the substrate, resulting in minimal package size.
4. Refer to recommended assembly tools in Application Tooling section.

Hermetically Sealed (Continued)

Panel Feed-through
Hermetic Adapter

Jack to Jack¹



Electrical
VSWR (GHz) — 1.10 + .01f
RF Leakage (dB) — -(100 - fGHz)

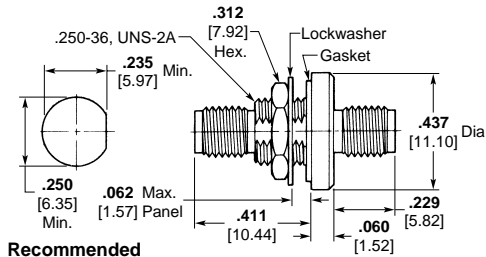

**Recommended
Mounting Hole**

M/A-COM Part No. (Ref. Only)	AMP Part No.
1084-1100-00	1045725-1

O-Ring Gasket Hermetic Seal

Flange Mount Jack Receptacle^{1,2}



Electrical
VSWR (GHz) — 1.05 + .01f
RF Leakage (dB) — -(70 - fGHz)

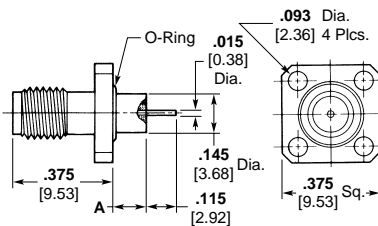

M/A-COM Part No. (Ref. Only)	AMP Part No.	Dim. A
1052-3121-00	1045593-1	.093 2.36

Rear Mount Jack Receptacle^{1,2}



Electrical
VSWR (GHz) — 1.05 + .014f
RF Leakage (dB) — -(70 - fGHz)

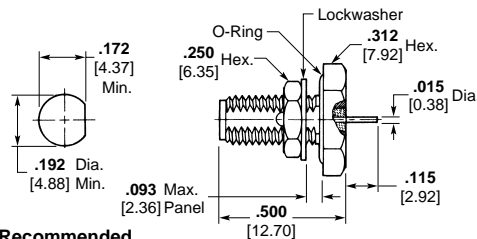

**Recommended
Mounting Hole**

M/A-COM Part No. (Ref. Only)	AMP Part No.
1056-3100-00	1045633-1

Bulkhead Feed-through
Front Mount Jack Receptacle



Electrical
VSWR (GHz) — 1.05 + .01f
RF Leakage (dB) — -(70 - fGHz)

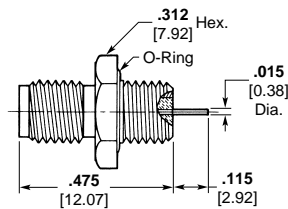

M/A-COM Part No. (Ref. Only)	AMP Part No.
1058-3100-00	1045642-1

1. Finish: Gold plate, -00. For passivated stainless steel, change the Part Number suffix from -00 to -02.
2. On passivated versions (-02), pins are pre-tinned using Sn60 solder.

In-Series Adapters

Jack to Jack Adapter

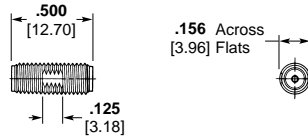

M/A-COM Part No. (Ref. Only)	AMP Part No.
1080-0000-02	1045701-1

Plug to Plug Adapter

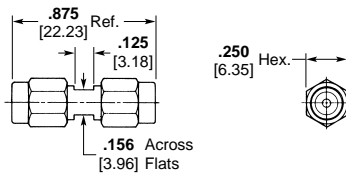

M/A-COM Part No. (Ref. Only)	AMP Part No.
1081-0000-02	1045704-1

Plug to Jack Adapter (Connector Saver)

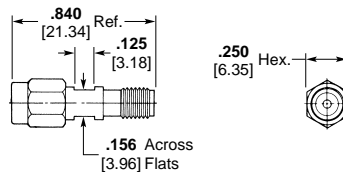

M/A-COM Part No. (Ref. Only)	AMP Part No.
1082-0000-02	1045708-1

Bulkhead Mount Jack to Jack Adapter

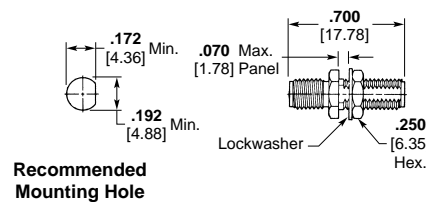

M/A-COM Part No. (Ref. Only)	AMP Part No.
1084-0000-02	1045723-1

Right-Angle Plug to Jack Adapter

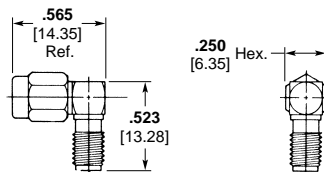

M/A-COM Part No. (Ref. Only)	AMP Part No.
1088-0000-02	1045747-1

Finish: Passivated stainless steel, -02. For gold plate, change the Part Number suffix from -02 to -00.

High Frequency For Semi-Rigid Cable

.085 [2.16] and .070 [1.78]
Dia. — Direct Solder
Attachment
Straight Cable Plug
(Without Center Contact)^{1,3}

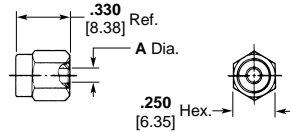

Specifications

Nominal Impedance — 50 ohms
Frequency Range — dc to 40 GHz
Voltage Standing Wave Ratio —
1.07 + .010 f (GHz)

Insertion Loss — $.04 \times \sqrt{f(\text{GHz})}$ = dB
max.

Voltage Rating — 250 volts RMS
max. working voltage

M/A-COM Part No. (Ref. Only)	AMP Part No.	Dim. A	RG/U Cable	Cable Dielectric
1001-7985-00	1045369-1	.087 2.2	405	Solid PTFE

Straight Cable Plug Center Contact^{1,3}

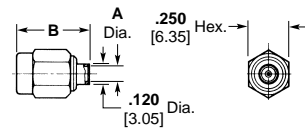

M/A-COM Part No. (Ref. Only)	AMP Part No.	Dim. A	Dim. B	RG/U Cable	Cable Dielectric
1401-7985-00	1046477-1	.088 2.22	.447 11.35	405	Solid PTFE

Straight Cable Jack³

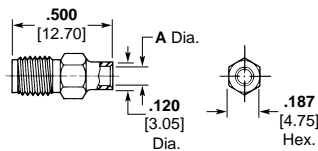

M/A-COM Part No. (Ref. Only)	AMP Part No.	Dim. A	RG/U Cable	Cable Dielectric
1402-7985-00	1046479-1	.088 2.22	405	Solid PTFE

Finish: Gold plate.

Panel Mount —
Straight Terminal
Flange Mount Jack Receptacle^{2,4}

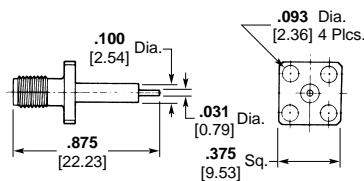

M/A-COM Part No. (Ref. Only)	AMP Part No.
1452-1201-02	1402389-1

1. Finish: Gold plated, -00. For passivated stainless steel coupling nut, change the Part Number suffix from -00 to -02. Inner housing that is soldered to cable is gold plated.
2. Finish: Passivated stainless steel, -02. For gold plate, change the Part Number suffix from -02 to -00.
3. Refer to recommended assembly tools in Application Tooling Section.
4. Captured center contact.

Hand Tools

AMP CERTI-CRIMP Hand Tools are our top-of-the-line crimping tools featuring the original ratcheted crimp control. All tools are designed to exacting specifications, and manufactured using high quality materials to provide long service life. Recommended for low production runs, repairs and prototype work, and applications requiring consistent, highly-reliable terminations. See Catalog 65780 for further information.

Typical CERTI-CRIMP Hand Tools with Integral (Non-Interchangeable) Dies



Part Number 58537-1
(used with PRO-CRIMPER Tool Frame 354940-1) for 50 Ohm BNC Dual Crimp MIL Type Connectors



Part Number 220015-1
for 50 Ohm N Connectors



CERTI-CRIMP Hand Tool with Interchangeable Dies



Part Number 69710

Hand Tool Kit for SMA and Blindmate Connectors

Part Number 59981-1



Item Description	Part Numbers	
	AMP	Military (M22520)
Hand Tool	59980-1	36-01
Plug Locator (without Center Contact)	220220-2	36-06
Plug Locator (with Center Contact)	220221-2	36-04
Jack Locator	220222-2	36-05
Die Set for RG-402/U Cable (.141 [3.58] O.D.)	312253-1	36-03
Die Set for RG-405/U Cable (.086 [2.18] O.D.)	312253-2	36-02
Cutoff Fixture	311395-1	36-09
Cable Dressing Fixture	311396-1	36-07
Trimmer Tool	312317-1	36-08
Cable Bend Fixture Assembly Includes following 6 items:	220224-1	36-10
Bend Segment, RG-402/U (.125 [3.18] Radius)	311386-1	36-11
Bend Segment, RG-402/U (.250 [6.35] Radius)	311386-2	36-12
Bend Segment, RG-405/U	311386-3	36-13
Tool Holder	311392-1	—
Limiting Pin	307581-1	—
Conforming Block	312067-1	—
Hex Wrench	21027-6	—
Carrying Case	13126-1	—
Insert, Case	13127-1	—

Application Tooling (Continued)

Solder Assembly Kit Brass SMA Connectors

AMP Kit Part Number
1055420-1
M/A-COM Kit Part Number
2098-5066-54
For installation of SMA
connectors to .035 [0.89]
and .141 [3.58] diameter
semi-rigid cable

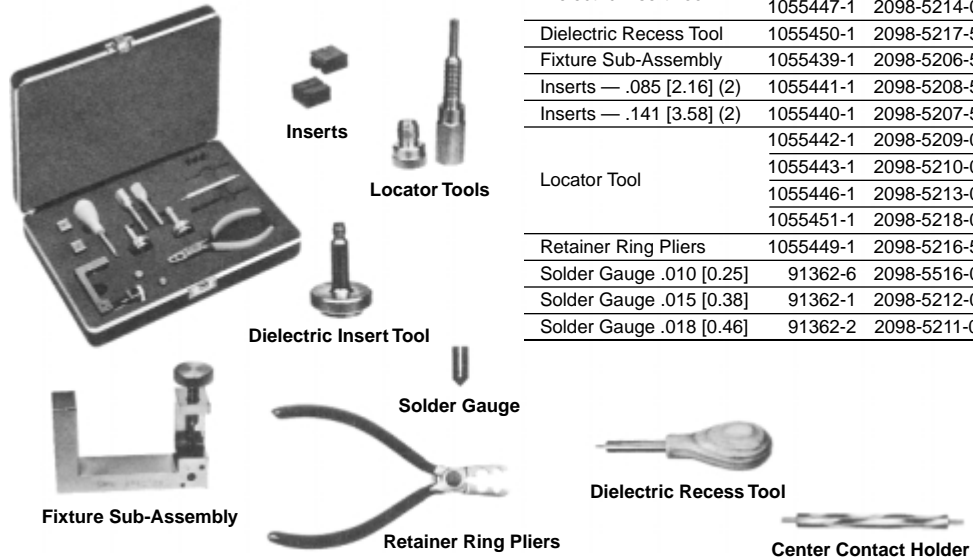

Item Description	AMP Part No.	M/A-COM Part No. (Ref. Only)
Center Contact Holder	1055454-1	2098-5221-10
Dielectric Insert Tool	1055448-1	2098-5215-02
	1055447-1	2098-5214-02
Dielectric Recess Tool	1055450-1	2098-5217-54
Fixture Sub-Assembly	1055439-1	2098-5206-54
Inserts — .085 [2.16] (2)	1055441-1	2098-5208-54
Inserts — .141 [3.58] (2)	1055440-1	2098-5207-54
	1055442-1	2098-5209-02
	1055443-1	2098-5210-02
Locator Tool	1055446-1	2098-5213-02
	1055451-1	2098-5218-02
Retainer Ring Pliers	1055449-1	2098-5216-54
Solder Gauge .010 [0.25]	91362-6	2098-5516-02
Solder Gauge .015 [0.38]	91362-1	2098-5212-02
Solder Gauge .018 [0.46]	91362-2	2098-5211-02

Universal Compression Crimp Tool

AMP Kit Part Number
1055835-1
M/A-COM Kit Part Number
2598-5200-54

AMP Universal Compression Crimp Tool offers the ability to rapidly produce cable assemblies using solderless compression crimp connectors with semi-rigid cables. This universal assembly tool kit will attach SMA, OSP, N and TNC series connectors to .141 [3.58], .085 [2.16] and .250 [6.35] cable quickly and consistently with excellent mechanical and electrical results.

The tool kit permits single hand assembly. Anvils and cable supports can be quickly changed. Crimp lengths can be adjusted from .001 [.025] to 1.000 [25.4] in increments of .001 [.025]. Sharp radius bends in cables are easily accommodated. The kit contains:



Description	AMP Part No.	M/A-COM Part No. (Ref. Only)
Crimp Frame	1055831-1	2598-5196-54
Calibration Gauge	1055832-1	2598-5197-54
.141 [3.58] Cable Support	1055833-1	2598-5198-54
.085 [2.16] Cable Support	1055834-1	2598-5199-54
SMA Plug Anvil	1055836-1	2598-5201-54
SMA Jack Anvil	1055837-1	2598-5202-54
Type N Plug Anvil	1055838-1	2598-5203-54
Type N Jack Anvil	1055839-1	2598-5204-54
TNC Plug Anvil	1055840-1	2598-5205-54
TNC Jack Anvil	1055841-1	2598-5206-54
OSP Plug Anvil	1055842-1	2598-5207-54
OSP Jack Anvil	1055843-1	2598-5208-54

All tools may be purchased separately.

Application Tooling (Continued)

**MIL-C-22520/10-01
Equivalent Hex Crimp Kit**

AMP Kit Part Number
1055236-1

M/A-COM Kit Part Number
2098-0105-54

For military specified applications requiring quick and efficient cable to connector attachment. Five popular hex die sizes are available to crimp the outer cable conductor to connector housings.



Die Change Tool



Crimp Tool



Hex Die

The kit contains:

Description	AMP Part Number	M/A-COM Part Number (Ref. Only)
Crimp Tool	1060713-1	9098-5105-54
Die Change Tool	1060716-1	5698-5014-54
Hex Die — A, B, C	1060714-1	5698-5015-54
Hex Die — D, E	1060715-1	5698-5016-54

All tools may be purchased separately. For the assembly of SMA connectors, Accessory Kit Part Number 1055421-1 is required.

A basic instruction sheet, included with the kit, aids in proper die selection

AMP Hex Die Part Number	M/A-COM Hex Die Part Number (Ref. Only)	Die	Hex Size ±.003 [0.08]	For Use With RG/U Cable
1060714-1	5698-5015-54	A	.105 2.67	178B & 196A
		B	.213 5.41	55B, 58C, 141A, 142B, 223, 303, & 400
		C	.128 3.25	174, 174B, 179, 187A, 188A, & 316
1060715-1	5698-5016-54	D	.178 4.52	180B, 195A, & 122
		E	.255 6.48	59, 62A, 71B, 210, & 302

Additional Dies Available

AMP Hex Die Part Number	M/A-COM Hex Die Part Number (Ref. Only)	Hex Size ±.003 [0.08]	For Use With RG/U Cable
1055270-1	2098-0323-54	.151 3.84	RD316 Double Braid

**SMA Crimp Tool
Accessory Kit**

AMP Kit Part Number
1055421-1

M/A-COM Kit Part Number
2098-5067-54

For installation of SMA connectors to flexible braided cable. Crimp type SMA connectors require Hex Crimp Kit Part Number 1055236-1.

The kit contains:

Description	AMP Part Number	M/A-COM Part Number (Ref. Only)
Center Contact Holder	1055454-1	2098-5221-10
Locator Tool	1055446-1	2098-5213-02
Locator Tool	1055451-1	2098-5218-02
Solder Gauge .015 [0.38]	91362-1	2098-5212-02

All tools may be purchased separately.



Locator Tool



Solder Gauge



Center Contact Holder

Stripping Tools

The hand-operated AMP Coaxial Cable Stripper features interchangeable, color-coded blade cassettes and V-blocks to accommodate 2- or 3-step stripping for cable diameters ranging from 2.54 [.10] through 7.62 [.30]. You strip cable by simply clamping and rotating the tool around the cable. See Instruction Sheet IS 2766 for further information.



For Use With Connector Type	Tool No.
BNC Single Crimp	603995-1
BNC Commercial and UHF Miniature	603995-2
UHF Standard	603995-3
BNC MIL Type Dual Crimp	603995-5
BNC Commercial Dual Crimp	603995-6

Semi-Rigid Cable Tooling

The tools listed here are designed specifically to strip and terminate semi-rigid cable. These tools operate basically the same as the flexible cable tools, in that they produce uniform terminations time after time, without heat damage from soldering.

Hand Tool for BNC and TNC Semi-Rigid Cable Connectors



Part Number 59980-1
Frame only — does not include dies and locator

Manual Trim and Point Tool

Tyco Electronics offers a manual tool that performs both trimming and pointing operations. Tools are available for .141 [3.58] and .085 [2.16] diameter semi-rigid cable. These hand-operated tools are ideally suited for engineering, small production runs or field use. They feature tungsten carbide cutters for durability up to 30 times longer than the life of a high speed steel cutter. Replacement cutters are interchangeable and may be purchased separately.



Replacement Cutters

Trimmer: Part Number 1055813-1

Pointer: Part Number 1055814-1

AMP Tool Part Number	M/A-COM Tool Part Number (Ref. Only)	Cable	Trim Length
1055811-1	2598-5116-54	RG-402/U (.141 [3.58])	.085 Fixed 2.16
1055815-1	2598-5120-54	RG-405/U (.085 [2.16])	.070 Fixed 1.78
1055823-1	2598-5137-54	RG-402/U (.141 [3.58])	Adjustable*
1055824-1	2598-5138-54	RG-405/U (.085 [2.16])	Adjustable*

*Adjustable trim length from .050 [1.27] to .140 [3.56].

Replacement Collets

AMP Part Number	M/A-COM Part Number (Ref. Only)	Cable
1055825-1	2598-5145-54	RG-402/U (.141 [3.58])
1055827-1	2598-5167-54	RG-405/U (.085 [2.16])

Cable Benders for Semi-Rigid Cable



Cable Bender

Description	AMP Part Number	M/A-COM Part Number (Ref. Only)	Bend Radius*
Cable Bender for RG-405/U (.085 [2.16])	1055479-1	2098-5287-54	1/4 [6.4] 3/8 [9.8]
Cable Bender for RG-402/U (.141 [3.58])	1055478-1	2098-5286-54	3/8 [9.8] 1/2 [12.7]

*Radius of the bend is measured from the centerline of the cable.

Trimming Tools for Semi-Rigid Cable

For soldered semi-rigid cable connectors using the cable center conductor as its contact. These tools are optional for most installations but recommended for optimum connector performance.



Trim Tool

Description	AMP Part Number	M/A-COM Part Number (Ref. Only)
Trim Tool for SMA Connectors RG-402/U (.141 [3.58])	1055455-1	2098-5272-02
Trim Tool for SSMA Connectors RG-405/U (.085 [2.16])	1055465-1	2098-5269-02

Application Tooling (Continued)

Cable Trimmers for Production

Tyco Electronics cable trimmers are designed for production trimming of RG-402/U (.141 [3.58]) and RG-405/U (.085 [2.16]) coaxial cables in preparation for connector installation. The trimming operation produces an unusually clean, burr-free cut with minimum smear. The length and depth of cut are adjustable. Replacement hardware can be used with either tool.

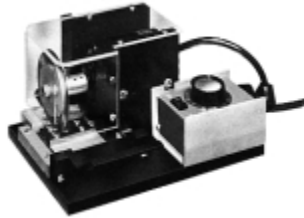

Cable Trimmers

Description	AMP Part Number	M/A-COM Part Number (Ref. Only)
RG-402/U (.141 [3.58])	1055526-1	2098-5676-54
RG-405/U (.085 [2.16])	1055530-1	2098-5686-54

Replacement Hardware

Description	AMP Part Number	M/A-COM Part Number (Ref. Only)
Saw Blade	1055524-1	2098-5674-54
Trim Saw Block (.141 [3.58])	1055527-1	2098-5678-54
Trim Saw Block (.085 [2.16])	1055528-1	2098-5679-54

Cable Pointers for Production

Tyco Electronics cable pointers are designed to point straight and bent cables and are adjustable for desired center conductor length. The cable pointers cut 90° point on copper as well as copper-clad center conductors.

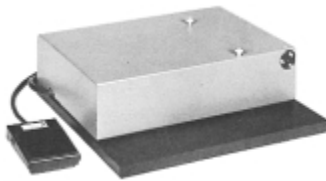

Cable Pointers

Description	AMP Part Number	M/A-COM Part Number (Ref. Only)	Cable	AMP Replacement Cutter Part Number	M/A-COM Replacement Cutter Part Number (Ref. Only)
Single Pointer	1055525-1	2098-5675-54	RG-402/U (.141 [3.58])	1055529-1	2098-5681-54
Single Pointer	1080269-1	2098-5685-54	RG-405/U (.085 [2.16])		

Interface Inspection Gauges

Tyco Electronics offers Connector Interface Gauges. They have shock proof and fully jeweled dial indicators. The rugged construction of the dial mechanism minimizes the need for repair or replacement.

The gauge heads are manufactured from a corrosion resistant, hardening stainless steel which is heat treated for longer life. All critical surfaces are ground and lapped for precision fit and superior surface finish. The heads are securely fastened onto the dial indicator for no movement between the gauge head and the dial indicator

spindle allowing for precise measurements.

Like the gauge heads, the plungers are specially designed to provide strength and durability.



Connector	Type	AMP Gauge Kit Part Number	M/A-COM Gauge Kit Part Number (Ref. Only)
SMA	Jack	1055496-1	2098-5455-54
	Plug	1055497-1	2098-5456-54

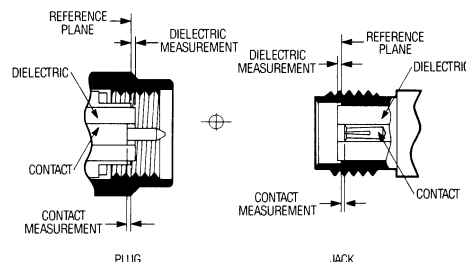

SMA Interface Example

Application Tooling (Continued)

SSMA Connectors

AMP Kit Part Number
1055466-1

M/A-COM Kit Part Number
2098-5270-54

For installation of SSMA connectors to .070 [1.78] and .085 [2.16] diameter semi-rigid cable.

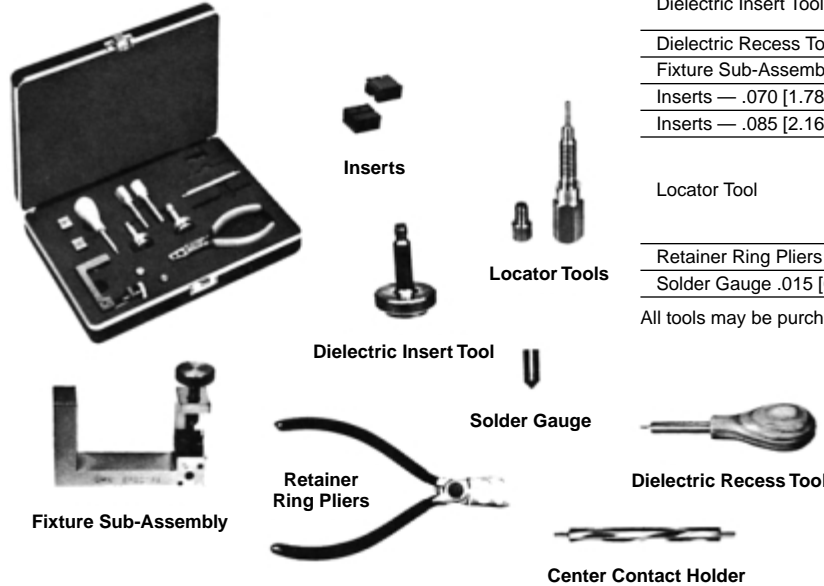

Item Description	AMP Part No.	M/A-COM Part No. (Ref. Only)
Center Contact Holder	1055463-1	2098-5237-10
Dielectric Insert Tool	1055458-1	2098-5233-02
	1055459-1	2098-5234-02
Dielectric Recess Tool	1055460-1	2098-5235-54
Fixture Sub-Assembly	1055439-1	2098-5206-54
Inserts — .070 [1.78] (2)	1055547-1	2098-5831-54
Inserts — .085 [2.16] (2)	1055441-1	2098-5208-54
	1055461-1	2098-5236-02
Locator Tool	1055464-1	2098-5238-02
	1055456-1	2098-5231-02
	1055457-1	2098-5232-02
Retainer Ring Pliers	1055449-1	2098-5216-54
Solder Gauge .015 [0.38]	91362-1	2098-5212-02

All tools may be purchased separately.

Econo-Crimp Assembly Kit

AMP Kit Part Number
1055779-1

M/A-COM Kit Part Number
2598-5005-54

For quick and efficient cable to connector attachment. Five popular hex die sizes are available to crimp the outer cable conductor to connector housings.



Item Description	AMP Part No.	M/A-COM Part No. (Ref. Only)
Crimp Tool	1055780-1	2598-5006-54
Hex Die — A, B, C	1055781-1	2598-5007-54
Hex Die — D, E	1055782-1	2598-5008-54

All tools may be purchased separately.

For the assembly of SMA connectors, Accessory Kit Part Number 2098-5067-54 is required. For SSMA connectors, Accessory Kit Part Number 2098-5272-54 is required.

AMP Hex Die Part Number	M/A-COM Hex Die Part Number (Ref. Only)	Die	Hex Size ±.003 [0.08]	For Use With RG/U Cable
1055781-1	2598-5007-54	A	.105 2.67	178B & 196A
		B	.213 5.41	55B, 58C, 141A, 142B, 223, 303, & 400
		C	.128 3.25	174, 174B, 179, 187A, 188A, & 316
1055782-1	2598-5008-54	D	.178 4.52	180B, 195A, & 122
		E	.255 6.48	59, 62A, 71B, 210, & 302

SSMA Crimp Tool Accessories

AMP Kit Part Number 1055467-1

M/A-COM Kit Model Number T-550

For installation of SSMA connectors to flexible braided cable. Crimp type SSMA connectors require Hex Crimp Kit Part Number 1055779-1.



Description	AMP Part Number	M/A-COM Part Number (Ref. Only)
Center Contact Holder	1055463-1	2098-5237-10
Locator Tool	1055461-1	2098-5236-02
	1055464-1	2098-5238-02

All tools may be purchased separately.

Military Part Number	M/A-COM Part Number	Tyco Part Number
M39012/01B0012		225092-7
M39012/01B0013		51692-4
M39012/01B007		225092-2
M39012/01B008		225092-1
M39012/02B008		225093-2
M39012/03B0004		225094-2
M39012/03B0005		225094-1
M39012/05B0002		225014-2
M39012/05B0002		225389-2
M39012/05B0003		225014-3
M39012/16B0004		2-331350-1
M39012/16B0007		2-331350-9
M39012/16B0008		331350
M39012/17B0004		2-331351-1
M39012/17B0008		331351
M39012/19-0102		221313-2
M39012/19B0003		1-331693-1
M39012/19B0007		331693
M39012/26B0005		225550-2
M39012/26B0006		225550-6
M39012/26B0007		225550-3
M39012/26B0016		225550-1
M39012/27B0005		225551-2
M39012/27B0006		225551-6
M39012/27B0015		225551-5
M39012/27B0016		225551-1
M39012/29B0005		225348-2
M39012/55-3006	2031-8006-92	1051757-1
M39012/55-3007	2031-8007-92	1051759-1
M39012/55-3008	2031-8008-92	1051760-1
M39012/55-3009	2031-8009-92	1051762-1
M39012/55-3010	2031-8010-92	1051763-1
M39012/55-3025	2031-8025-92	1051780-1
M39012/55-3026	2031-8026-92	1051782-1
M39012/55-3027	2031-8027-92	1051783-1
M39012/55-3028	2031-8028-92	1051785-1
M39012/55-3029	2031-8029-92	1051787-1
M39012/55-3106	2031-8106-92	1051789-1
M39012/55-3107	2031-8107-92	1051791-1
M39012/55-3108	2031-8108-92	1051792-1
M39012/55-3109	2031-8109-92	1051794-1
M39012/55-3110	2031-8110-92	1051795-1
M39012/55-3125	2031-8125-92	1051810-1
M39012/55-3126	2031-8126-92	1051812-1
M39012/55-3127	2031-8127-92	1051813-1
M39012/55-3128	2031-8128-92	1051815-1
M39012/55-3129	2031-8129-92	1051816-1
M39012/55-3502	2031-8052-92	1051788-1
M39012/55-3602	2031-8162-92	1051817-1
M39012/55-4026		1532129-5
M39012/55-4027		1532129-7
M39012/55-4028		1532129-9
M39012/55-4029		1-1532129-1
M39012/55-4126		1532129-6
M39012/55-4127		1532129-8
M39012/55-4128		1-1532129-0
M39012/55-4129		1-1532129-2
M39012/55B3011	2031-8011-92	1051764-1
M39012/55B3012	2031-8012-92	1051766-1
M39012/55B3013	2031-8013-92	1051767-1
M39012/55B3014	2031-8014-92	1051768-1

Military Part Number	M/A-COM Part Number	Tyco Part Number
M39012/55B3015	2031-8015-92	1051769-1
M39012/55B3016	2031-8016-92	1051770-1
M39012/55B3017	2031-8017-92	1484541-1
M39012/55B3018	2031-8018-92	1051771-1
M39012/55B3019		225532-4
M39012/55B3019	2031-8019-92	1056413-1
M39012/55B3020	2031-8020-92	1051774-1
M39012/55B3021		225532-1
M39012/55B3021	2031-8021-92	1051775-1
M39012/55B3022		225532-3
M39012/55B3022	2031-8022-92	1051776-1
M39012/55B3023		1-225532-0
M39012/55B3023	2031-8023-92	1051777-1
M39012/55B3024		225532-9
M39012/55B3024	2031-8024-92	1051778-1
M39012/55B3111	2031-8111-92	1051796-1
M39012/55B3112	2031-8112-92	1051797-1
M39012/55B3113	2031-8113-92	1051798-1
M39012/55B3114	2031-8114-92	1051799-1
M39012/55B3115	2031-8115-92	1051800-1
M39012/55B3116	2031-8116-92	1051801-1
M39012/55B3117	2031-8117-92	1051802-1
M39012/55B3118	2031-8118-92	1051803-1
M39012/55B3119	2031-8119-92	1051804-1
M39012/55B3120	2031-8120-92	1051805-1
M39012/55B3121	2031-8121-92	1051806-1
M39012/55B3122	2031-8122-92	1051807-1
M39012/55B3123	2031-8123-92	1051808-1
M39012/55B3124	2031-8124-92	1051809-1
M39012/56-3006	2037-8006-92	1052149-1
M39012/56-3007	2037-8007-92	1052151-1
M39012/56-3008	2037-8008-92	1052152-1
M39012/56-3009	2037-8009-92	1052154-1
M39012/56-3010	2037-8010-92	1052155-1
M39012/56-3025	2037-8025-92	1052171-1
M39012/56-3026	2037-8026-92	1052173-1
M39012/56-3027	2037-8027-92	1052174-1
M39012/56-3028	2037-8028-92	1052176-1
M39012/56-3029	2037-8029-92	1052177-1
M39012/56-3106	2037-8106-92	1052179-1
M39012/56-3107	2037-8107-92	1052181-1
M39012/56-3108	2037-8108-92	1052182-1
M39012/56-3109	2037-8109-92	1052184-1
M39012/56-3110	2037-8110-92	1052185-1
M39012/56-3125	2037-8125-92	1052201-1
M39012/56-3126	2037-8126-92	1052203-1
M39012/56-3127	2037-8127-92	1052204-1
M39012/56-3128	2037-8128-92	1052206-1
M39012/56-3129	2037-8129-92	1052207-1
M39012/56-3502	2037-8052-92	1052178-1
M39012/56-3602	2037-8162-92	1086723-1
M39012/56B3011	2037-8011-92	1052156-1
M39012/56B3012	2037-8012-92	1052157-1
M39012/56B3013	2037-8013-92	1052158-1
M39012/56B3014	2037-8014-92	1052159-1
M39012/56B3015	2037-8015-92	1052160-1
M39012/56B3016	2037-8016-92	1052161-1
M39012/56B3017	2037-8017-92	1052162-1
M39012/56B3018	2037-8018-92	1052163-1
M39012/56B3019		225609-4
M39012/56B3019	2037-8019-92	1052165-1

Military Part Number	M/A-COM Part Number	Tyco Part Number
M39012/56B3020	2037-8020-92	1052166-1
M39012/56B3021		225609-1
M39012/56B3021	2037-8021-92	1052167-1
M39012/56B3022		225609-3
M39012/56B3022	2037-8022-92	1052168-1
M39012/56B3023	2037-8023-92	1052169-1
M39012/56B3024	2037-8024-92	1052170-1
M39012/56B3111	2037-8111-92	1052186-1
M39012/56B3112	2037-8112-92	1052187-1
M39012/56B3113	2037-8113-92	1052188-1
M39012/56B3114	2037-8114-92	1052189-1
M39012/56B3115	2037-8115-92	1052190-1
M39012/56B3116	2037-8116-92	1052191-1
M39012/56B3117	2037-8117-92	1052192-1
M39012/56B3118	2037-8118-92	1052193-1
M39012/56B3119	2037-8119-92	1052194-1
M39012/56B3120	2037-8120-92	1052195-1
M39012/56B3121	2037-8121-92	1052196-1
M39012/56B3122	2037-8122-92	1052197-1
M39012/56B3123	2037-8123-92	1052198-1
M39012/56B3124	2037-8124-92	1052199-1
M39012/57-3006	2032-8006-92	1090174-1
M39012/57-3007	2032-8007-92	1051900-1
M39012/57-3008	2032-8008-90	1051901-1
M39012/57-3009	2032-8009-90	1051902-1
M39012/57-3010	2032-8010-90	1051903-1
M39012/57-3025	2032-8025-92	1051918-1
M39012/57-3026	2032-8026-92	1051919-1
M39012/57-3027	2032-8027-92	1051920-1
M39012/57-3028	2032-8028-92	1051921-1
M39012/57-3029	2032-8029-92	1051922-1
M39012/57-3502	2032-8052-92	1051923-1
M39012/57B3011	2032-8011-92	1051904-1
M39012/57B3012	2032-8012-92	1051905-1
M39012/57B3013	2032-8013-92	1051906-1
M39012/57B3014	2032-8014-92	1051907-1
M39012/57B3015	2032-8015-92	1051908-1
M39012/57B3016	2032-8016-92	1051909-1
M39012/57B3017	2032-8017-92	1051910-1
M39012/57B3018	2032-8018-92	1051911-1
M39012/57B3019	2032-8019-92	1051912-1
M39012/57B3020	2032-8020-92	1051913-1
M39012/57B3021	2032-8021-92	1051914-1
M39012/57B3022	2032-8022-92	1051915-1
M39012/57B3023	2032-8023-92	1051916-1
M39012/57B3024	2032-8024-92	1051917-1
M39012/58-3006	2036-8006-92	1052037-1
M39012/58-3007	2036-8007-92	1052038-1
M39012/58-3008	2036-8008-90	1052039-1
M39012/58-3009	2036-8009-90	1052040-1
M39012/58-3010	2036-8010-90	1052041-1
M39012/58-3025	2036-8025-92	1052046-1
M39012/58-3026	2036-8026-92	1052047-1
M39012/58-3027	2036-8027-92	1052048-1
M39012/58-3028	2036-8028-92	1052049-1
M39012/58-3029	2036-8029-92	1052050-1
M39012/58-3502	2036-8052-92	1052051-1
M39012/58B3011	2036-8011-92	1052042-1
M39012/58B3012	2036-8012-92	1254028-1
M39012/58B3013	2036-8013-92	1484499-1
M39012/58B3014	2036-8014-92	1484500-1

Military Part Number	M/A-COM Part Number	Tyco Part Number
M39012/58B3015	2036-8015-92	1052043-1
M39012/58B3016	2036-8016-92	1484501-1
M39012/58B3017	2036-8017-92	1484502-1
M39012/58B3018	2036-8018-92	1484504-1
M39012/58B3019	2036-8019-92	1484503-1
M39012/58B3020	2036-8020-92	1484504-1
M39012/58B3021	2036-8021-92	1484505-1
M39012/58B3022	2036-8022-92	1052045-1
M39012/58B3023	2036-8023-92	1484506-1
M39012/58B3024	2036-8024-92	1484507-1
M39012/59-3006	2034-8006-92	1051981-1
M39012/59-3007	2034-8007-92	1051982-1
M39012/59-3008	2034-8008-90	1051983-1
M39012/59-3009	2034-8009-90	1051984-1
M39012/59-3010	2034-8010-90	1051985-1
M39012/59-3025	2034-8025-92	1051992-1
M39012/59-3026	2034-8026-92	1051994-1
M39012/59-3027	2034-8027-92	1051995-1
M39012/59-3028	2034-8028-92	1051996-1
M39012/59-3029	2034-8029-92	1051997-1
M39012/59-3502	2034-8052-92	1051999-1
M39012/59-4026		1-1532129-3
M39012/59-4027		1-1532129-4
M39012/59-4028		1-1532129-5
M39012/59-4029		1-1532129-6
M39012/59B3011	2034-8011-92	1362216-1
M39012/59B3012	2034-8012-92	1051986-1
M39012/59B3013	2034-8013-92	1083993-1
M39012/59B3014	2034-8014-92	1331293-1
M39012/59B3015	2034-8015-92	1253627-1
M39012/59B3016	2034-8016-92	1221165-1
M39012/59B3017	2034-8017-92	1484542-1
M39012/59B3018	2034-8018-92	1051987-1
M39012/59B3019	2034-8019-92	1051988-1
M39012/59B3020	2034-8020-92	1484543-1
M39012/59B3021	2034-8021-92	1087842-1
M39012/59B3022	2034-8022-92	1051989-1
M39012/59B3023	2034-8023-92	1051990-1
M39012/59B3024	2034-8024-92	1051991-1
M39012/60-3001	2052-8001-92	1052924-1
M39012/60-3002	2052-8002-92	1052926-1
M39012/61-3001	2056-8011-92	1053118-1
M39012/61-3002	2058-8012-92	1484516-1
M39012/79-3007	2001-8007-92	1050781-1
M39012/79-3008	2001-8008-92	1050783-1
M39012/79-3107	2001-8107-92	1050789-1
M39012/79-3108	2001-8108-92	1050790-1
M39012/79-3207		228639-3
M39012/79-3207	2001-8207-92	1050793-1
M39012/79-3208	2001-8208-92	1050794-1
M39012/79-3307		228639-1
M39012/79-3307	2001-8307-92	1050800-1
M39012/79-3308		228634-1
M39012/79-3308	2001-8308-92	1050801-1
M39012/79-3311	2001-8311-92	1050803-1
M39012/79B3001	2001-8001-92	1050774-1
M39012/79B3002	2001-8002-92	1058590-1
M39012/79B3002	2001-8002-92	1050776-1
M39012/79B3003	2001-8003-92	1050777-1
M39012/79B3003	2001-8991-92	1050813-1
M39012/79B3003	2001-8203-92	1089686-1

Military Part Number	M/A-COM Part Number	Tyco Part Number
M39012/79B3004	2001-8004-92	1050779-1
M39012/79B3004	2001-8204-92	1050792-1
M39012/79B3101	2001-8101-92	1050785-1
M39012/79B3102	2001-8102-92	1050786-1
M39012/79B3103		227868-1
M39012/79B3103	2001-8103-92	1050787-1
M39012/79B3103	2001-8303-92	1050797-1
M39012/79B3103	2001-8981-92	1050812-1
M39012/79B3104		227743-1
M39012/79B3104	2001-8104-92	1050788-1
M39012/79B3104	2001-8304-92	1050799-1
M39012/80-3005	2007-8005-92	1051165-1
M39012/80-3006	2007-8006-92	1051166-1
M39012/80-3007	2007-8007-92	1051168-1
M39012/80-3008	2007-8008-92	1051170-1
M39012/80-3105	2007-8105-92	1051175-1
M39012/80-3106	2007-8106-92	1051176-1
M39012/80-3107	2007-8107-92	1051177-1
M39012/80-3108	2007-8108-92	1051178-1
M39012/80-3207		228583-3
M39012/80-3207		228583-5
M39012/80-3307		228583-1
M39012/80-3308		228626-1
M39012/80-3308		228626-5
M39012/80B3001	2007-8001-92	1051160-1
M39012/80B3002	2007-8002-92	1051161-1
M39012/80B3003	2007-8003-92	1051163-1
M39012/80B3004	2007-8004-92	1051164-1
M39012/80B3101	2007-8101-92	1051171-1
M39012/80B3102	2007-8102-92	1051172-1
M39012/80B3103	2007-8103-92	1051173-1
M39012/80B3104	2007-8104-92	1051174-1
M39012/81-3005	2002-8005-90	1050926-1
M39012/81-3006	2002-8006-90	1050928-1
M39012/81-3007	2002-8007-92	1050929-1
M39012/81-3008	2002-8008-92	1050931-1
M39012/81-3207	2002-8207-92	1050934-1
M39012/81-3208	2002-8208-92	1050935-1
M39012/81B3001	2002-8001-90	1050923-1
M39012/81B3002	2002-8002-90	1050924-1
M39012/81B3003	2002-8003-92	1084643-1
M39012/81B3003	2002-8203-92	1050932-1
M39012/81B3004	2002-8004-92	1050925-1
M39012/81B3004	2002-8204-92	1050933-1
M39012/82-3005	2006-8005-90	1051091-1
M39012/82-3006	2006-8006-90	1051092-1
M39012/82-3007	2006-8007-92	1051093-1
M39012/82-3008	2006-8008-92	1051094-1
M39012/82-3207	2006-8207-92	1051097-1
M39012/82-3208	2006-8208-92	1051098-1
M39012/82B3001	2006-8001-90	1051087-1
M39012/82B3002	2006-8002-90	1051088-1
M39012/82B3003	2006-8003-92	1051089-1
M39012/82B3003	2006-8203-92	1051095-1
M39012/82B3004	2006-8004-92	1051090-1
M39012/82B3004	2006-8204-92	1051096-1
M39012/83-3005	2004-8005-90	1051026-1
M39012/83-3006	2004-8006-90	1051027-1
M39012/83-3007	2004-8007-92	1051028-1
M39012/83-3008	2004-8008-92	1051029-1
M39012/83-3207	2004-8207-92	1051032-1

Military Part Number	M/A-COM Part Number	Tyco Part Number
M39012/83-3208	2004-8208-92	1051033-1
M39012/83B3001	2004-8001-90	1051022-1
M39012/83B3002	2004-8002-90	1051023-1
M39012/83B3003	2004-8003-92	1051024-1
M39012/83B3003	2004-8203-92	1051030-1
M39012/83B3004	2004-8004-92	1051025-1
M39012/83B3004	2004-8204-92	1051031-1
M39012/92-3201	2001-8201-92	1050791-1
M39012/92-3301		228635-1
M39012/92-3301		228635-6
M39012/92-3301	2001-8301-92	1050796-1
M39012/92B3001	2001-8921-92	1050808-1
M39012/92B3001	2001-8901-92	1050805-1
M39012/92B3001	2001-8941-92	1484517-1
M39012/92B3101		227531-1
M39012/92B3101	2001-8911-92	1050807-1
M39012/92B3101	2001-8931-92	1050809-1
M39012/92B3101	2001-8951-92	1050810-1
M39012/93-3001	2062-8001-90	1053372-1
M39012/93-3002	2062-8002-90	1053374-1
M39012/93-3003	2062-8003-90	1053376-1
M39012/94-3001	2064-8001-90	1053396-1
M39012/94-3002	2064-8002-90	1053398-1
M39012/94-3003	2064-8003-90	1053400-1
M55339/02-30001	2088-8001-92	1055091-1
M55339/28-30001	2084-8001-92	1054986-1
M55339/28-30002	2084-8002-92	1054988-1
M55339/29-30001	2081-8001-92	1053765-1
M55339/29-30101	2081-8101-92	1053767-1
M55339/31-30001	2081-8001-92	1053633-1
M83517/1-31001	2052-8003-92	1052928-1
M83517/1-31002	2052-8004-92	1052930-1
M83517/1-31003	2052-8005-92	1052932-1
M83517/1-31004	2052-8006-92	1052934-1
M83517/1-32001	2052-8003-90	1052927-1
M83517/1-32002	2052-8004-90	1052929-1
M83517/1-32003	2052-8005-90	1052931-1
M83517/1-32004	2052-8006-90	1052933-1
M83517/2-31001	2051-8001-92	1052409-1
M83517/2-31002	2051-8002-92	1052411-1
M83517/2-31003	2051-8003-92	1052413-1
M83517/2-31004	2051-8004-92	1052415-1
M83517/2-32001	2051-8001-90	1052408-1
M83517/2-32002	2051-8002-90	1052410-1
M83517/2-32003	2051-8003-90	1052412-1
M83517/2-32004	2051-8004-90	1052414-1
M83517/3-31001	2052-8007-92	1052936-1
M83517/3-31002	2052-8008-92	1052938-1
M83517/3-31003	2052-8009-92	1052940-1
M83517/3-31004	2052-8010-92	1052942-1
M83517/3-31005	2052-8011-92	1052944-1
M83517/3-31006	2052-8012-92	1052946-1
M83517/3-31007	2052-8013-92	1052948-1
M83517/3-32001	2052-8007-90	1052935-1
M83517/3-32002	2052-8008-90	1052937-1
M83517/3-32003	2052-8009-90	1052939-1
M83517/3-32004	2052-8010-90	1052941-1
M83517/3-32005	2052-8011-90	1052943-1
M83517/3-32006	2052-8012-90	1052945-1
M83517/3-32007	2052-8013-90	1052947-1
M83517/4-31001	2052-8014-92	1052950-1

Military Part Number	M/A-COM Part Number	Tyco Part Number
M83517/4-31002	2052-8015-92	1052952-1
M83517/4-31003	2052-8016-92	1052954-1
M83517/4-31004	2052-8017-92	1052956-1
M83517/4-32001	2052-8014-90	1052949-1
M83517/4-32002	2052-8015-90	1052951-1
M83517/4-32003	2052-8016-90	1052953-1
M83517/4-32004	2052-8017-90	1052955-1
M83517/4-32005	2052-8018-90	1052957-1
M83517/5-31001	2051-8005-92	1052417-1
M83517/5-32002	2051-8005-90	1052416-1
M83517/6-31001	2066-8001-92	1053423-1
M83517/6-31002	2066-8002-92	1053425-1
M83517/6-32001	2066-8001-90	1053422-1
M83517/6-32002	2066-8002-90	1053424-1
M83517/7-31001	2067-8001-92	1053429-1
M83517/7-31002	2067-8002-92	1053431-1
M83517/7-32001	2067-8001-90	1053428-1
M83517/7-32002	2067-8002-90	1053430-1
M83517/8-31001	2068-8001-92	1053451-1
M83517/8-31002	2068-8002-92	1053453-1
M83517/8-32001	2068-8001-90	1053450-1
M83517/8-32002	2068-8002-90	1053452-1

Military Part Number	M/A-COM Part Number	Tyco Part Number
M83517/9-31001	2070-8001-92	1053476-1
M83517/9-31002	2070-8002-92	1053478-1
M83517/9-31003	2070-8003-92	1053480-1
M83517/9-31004	2070-8004-92	1053482-1
M83517/9-32001	2070-8001-90	1053475-1
M83517/9-32002	2070-8002-90	1053477-1
M83517/9-32003	2070-8003-90	1053479-1
M83517/9-32004	2070-8004-90	1053481-1
M83517/10-31001	2052-8019-92	1052959-1
M83517/10-31003	2052-8021-90	1052961-1
M83517/10-31003	2052-8021-92	1052962-1
M83517/10-31004	2052-8023-92	1052963-1
M83517/10-31005	2052-8023-92	1052963-1
M83517/10-31006	2052-8024-92	1484518-1
M83517/10-31015	2052-8033-92	1484519-1
M83517/10-31016	2052-8034-92	1484520-1
M83517/10-32001	2052-8019-90	1484521-1
M83517/10-32005	2052-8023-90	1484522-1
M83517/10-32006	2052-8024-90	1484523-1
M83517/10-32015	2052-8033-90	1484524-1
M83517/10-32016	2052-8034-90	1484525-1

OSMP Cross Reference

Tyco Part Number	M/A-COM Part Number
1056526-1	2902 7947 62
1056527-1	2902 7985 62
1056553-1	2908 7947 62
1056554-1	2908 7985 62
1059829-1	2980 0000 62
1056745-1	2980 2240 00
1056743-1	2981 2241 00
1056744-1	2982 2240 00
1056721-1	2982 2241 00

Tyco Part Number	M/A-COM Part Number
1056722-1	2998 5001 02
1056724-1	2998 5002 02
1056729-1	2998 5003 02
1056731-1	2998 5005 02
1056749-1	2998 5022 94
1056726-1	2998 5028 02
1056734-1	2998 5030 02
1056736-1	2998 5033 02
1056750-1	2998 5035 02

Tyco Part Number	M/A-COM Part Number
1056751-1	2998 5043 02
1056752-1	2998 5044 02
1056728-1	2998 5045 02
1056706-1	2998 5049 02
1056702-1	2998 5054 94
1056707-1	2998 5055 94
1056708-1	2998 5056 94

SSMA Cross Reference

Tyco Part Number	M/A-COM Part Number
1045370-1	1001 5004 02
1045351-1	1001 7985 00
1045381-1	1001 7985 02
1045401-1	1002 7985 00
1045410-1	1004 7985 00
1045423-1	1006 7985 00
1045477-1	1007 7985 02
1045482-1	1031 5001 02
1045496-1	1031 5002 02
1045497-1	1031 7188 02
1045508-1	1032 5001 00
1045511-1	1032 5002 00
1045489-1	1034 7188 02
1045506-1	1034 7196 02
1045503-1	1037 5001 02
1045520-1	1037 5002 02

Tyco Part Number	M/A-COM Part Number
1045568-1	1037 7188 02
1045582-1	1052 0000 00
1045621-1	1052 1132 00
1045630-1	1052 1200 12
1045632-1	1052 1201 02
1045637-1	1052 1300 02
1045576-1	1052 1302 02
1045578-1	1052 3121 00
1045586-1	1052 3355 02
1045672-1	1052 5013 00
1045677-1	1054 5005 02
1045573-1	1056 0000 02
1045607-1	1056 1100 02
1045598-1	1056 3100 00
1045651-1	1058 0000 02
1045647-1	1058 3100 00

Tyco Part Number	M/A-COM Part Number
1045643-1	1058 3121 00
1045645-1	1058 3122 00
1045646-1	1058 3123 00
1045725-1	1058 3203 00
1045593-1	1058 5014 00
1045633-1	1062 0000 00
1045642-1	1064 0000 00
1045701-1	1080 0000 02
1045704-1	1081 0000 02
1045708-1	1082 0000 02
1045723-1	1084 0000 02
1045747-1	1084 1100 00
1045369-1	1088 0000 02
1046477-1	1401 7985 00
1046479-1	1402 7985 00
1402389-1	1452 1201 02

Introduction

Product Facts

- Designed to accept 50, 70 and 93 ohm miniature coaxial cables
- Three types of connectors: Screw-on Series, Slide-on Series and Quick-Connect Series
- Temperature range —
-85°F to +257°F [-65°C to +125°C] (with neoprene gasket or bend relief cap)
-80°F to 392°F [-62°C to +200°C] (with silicone gasket or bend relief cap)
- Dielectric Withstanding Voltage — 1000 volts RMS at sea level
- Contact Resistance — 3 milliohms max., D.C.
- Captive Contacts — Terminated connector contacts captivated from movement in both directions



MICRODOT Standard Coaxial Connectors are designed to accept 50, 70, and 93 Ohm miniature coaxial cables. These connectors are available as Screw-On Series, Slide-On Series, or Quick-Connect Series. The Screw-On Series is intermateable with

the Gold Plated Crimp Style Coaxial Connector Series and offers the dependability of a threaded coupling. For enhanced safety, choose connectors with wire holes.

Choose Slide-On Series for the fastest, most convenient mating and unmating.

The Quick-Connect Series offers the convenience of Slide-On coupling with added retention provided by a snap ring located on the jack/receptacle side.

Consult Tyco Electronics for special cable accommodations and mounting features.

Performance Data
Summary
For Standard Connectors

Coaxial Connectors

Standard Connectors

Mechanical

Captive Contacts — Terminated connector contacts captivated from movement in both directions.

Cable Retention —
50 Ohm connectors, 15 lb. min.¹
70 Ohm connectors, 25 lb. min.¹
93 Ohm connectors, 35 lb. min.¹

Recommended Coupling Torque (Threaded Interface) —
8 inch/pounds max.

Recommended Receptacle Mounting Torque (All Series) —
8 inch/pounds max.

Unmating Force (Slide-On Series) —
1-7 pounds.

Contact Protection (Unmated) —
Pin contact protected by coupling nut (threaded series)² or by housing (Quick-Connect and Slide-On Series). Socket protected by insulator and housing.

Assembly Methods

Straight Plugs & Jacks — Cable Inner Conductor: Soldered to contact. Cable Shield: Crimped to jerk ring (solder optional).

Angle Plugs — Cable Inner Conductor: Soldered to contact. Cable Shield: Soldered to ring & housing.

Environmental

Temperature Range (Continuous Service) — -85°F to +257°F [-65°C to +125°C] (with Neoprene gasket or bend relief cap). -80°F to 392°F [-62°C to +200°C] (with Silicone gasket or bend relief cap).

Vibration^{3,4} — MIL-STD-202, Method 204, Test condition B (15 G peak). No physical damage or electrical discontinuities in excess of 1 microsecond.

Shock^{3,4} — MIL-STD-202, Method 213, Test Condition H. No physical damage or electrical discontinuity after shock.

Thermal Shock — MIL-STD-202, Method 107, Test Condition B.

Moisture Resistance³ — MIL-STD-202, Method 106.

Salt Spray³ — MIL-STD-202, Method 101, Test Condition B (48 hours).

Electrical

Impedance — Designed to be compatible with 50, 70, or 93 Ohm miniature coaxial cable.

Dielectric Withstanding Voltage — 1000 volts RMS at sea level.

Contact Resistance — 3 milliohms max., D.C.

Contact Capacity — 3 amps, D.C.

Insulation Resistance — 5 x 10³ Megohms min. @ 500 volts D.C.

Voltage Standing Wave Ratio⁵ (VSWR) — Typical 50 Ohm series, 1.2 max. to 2 GHz.

Materials

Housing, Nut, Jerk Ring — Brass per ASTM-B-16.

Insulator — TEFLON per ASTM-D-1710.

Pin Contact (Plugs) — Brass per ASTM-B-16.

Socket Contact (Jacks & Receptacles) — Beryllium Copper per ASTM-B-196.

Bend Relief Caps (Plugs & Jacks) — Neoprene or Silicone Rubber per ZZ-R-765.

Gaskets (Jacks & Receptacles) — Neoprene or Silicone Rubber per ZZ-R-765.

Lockwasher — #425 Bronze Alloy.

Plating

Contacts — Gold per MIL-G-45204, Type II, Grade C, Class 1.

Housing, Nut, Jerk Ring, Lockwasher — Silver per QQ-S-365, Type II, Grade A, .0002 [.005] min.

Notes:

¹Termination to cables with foamed dielectrics excluded. Straight connector jerk rings must be soldered to cable shield.

²Pin protector required. See individual connector specifications.

³Screw-On Series, threaded interface.

⁴Tyco Electronics recommends the use of safety wired connectors in vibration and shock environment.

See individual specifications for connectors with safety wire holes.

⁵VSWR is a system specification.

Where performance is critical, purchase Tyco Electronics cable assemblies with Screw-On or Quick-Connect Series connectors and specify VSWR testing and mating connector part number.

See page 7106 for mating options.



Plug

S-50 Ohm Series	S-70 Ohm Series	S-93 Ohm Series
032-0021-0001	032-0010-0001	032-0011-0001
032-0023-0001	032-0022-0001	032-0017-0001
032-0025-0001	032-0067-0001	032-0066-0001
032-0033-0001	032-0078-0001	032-0071-0001
032-0097-0001	032-0222-0001	032-0092-0001
032-0098-0001	052-0092-0001	032-0099-0001
032-0155-0001		052-0200-0001
032-0156-0001		
052-0213-0001		
052-0235-0001		
052-0235-0003		
052-0370-0001		
052-0542-0001		

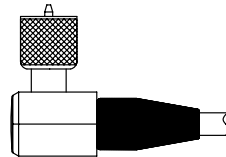

Right-Angle Plug

S-50 Ohm Series	S-70 Ohm Series	S-93 Ohm Series
032-0015-0001	032-0013-0001	032-0014-0001
052-0204-0001	052-0299-0001	032-0068-0001
052-0215-0001	052-0379-0001	032-0153-0001
052-0337-0001		052-0207-0001
		052-0298-0001
		052-0304-0022

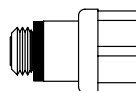

Printed Circuit Receptacle

S-50 Ohm Series	S-70 Ohm Series	S-93 Ohm Series
031-0059-0001	031-0069-0001	031-0067-0001
031-0062-0001		031-0080-0001
051-0450-0001		



Jack

S-50 Ohm Series	S-70 Ohm Series	S-93 Ohm Series
031-0034-0001	031-0036-0001	031-0037-0001
051-0467-0001	031-0090-0001	031-0088-0001

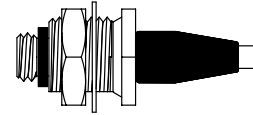

Bulkhead Jack

S-50 Ohm Series	S-70 Ohm Series	S-93 Ohm Series
031-0033-0001	031-0048-0001	031-0032-0001
		031-0089-0001

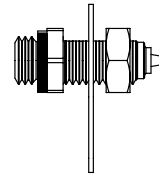

Receptacle

S-50 Ohm Series	S-70 Ohm Series	S-93 Ohm Series
031-0050-0001	031-0051-0001	031-0052-0001
051-0318-0001		

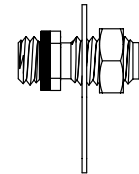

Receptacle

S-50 Ohm Series	S-70 Ohm Series	S-93 Ohm Series
031-0001-0001	031-0017-0001	031-0016-0001
031-0001-0003	031-0018-0001	031-0019-0001
031-0002-0001		031-0046-0001
031-0003-0001		
031-0024-0001		
051-0125-0001		

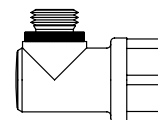

Right-Angle Printed Circuit Receptacle

S-50 Ohm Series	S-70 Ohm Series	S-93 Ohm Series
031-0061-0001	031-0072-0001	031-0073-0001
051-0459-0001		

Standard Connectors — Screw-On Series (Continued)

Plugs

S-50, 70 & 93

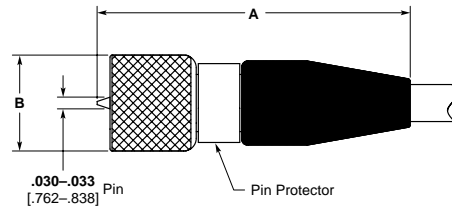
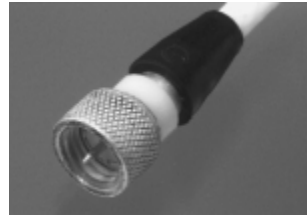

Part No.	Dim. A	Dim. B	Cable Jacket Max.	Special Features	Instruction Sheet No.	Former MICRODOT I.S. No.	Assembly Tool
S-50 Series (50 Ohm) .190 [4.83] -32 UNF-2B Thread							
032-0021-0001	.745 18.92	.230 5.84	Dia.	.087 2.21	'Solderless Assembly	408-08521	RF-ASMB-88 010-0003-0000
032-0023-0001	.745 18.92	.230 5.84	Dia.	.087 2.21	¹	408-08522	RF-ASMB-89 010-0003-0000
032-0025-0001	.745 18.92	.230 5.84	Dia.	.093 2.36	'Solderless Assembly	408-08521	RF-ASMB-88 010-0003-0000
032-0033-0001	.745 18.92	.230 5.84	Dia.	.093 2.36	¹	408-08522	RF-ASMB-89 010-0003-0000
032-0097-0001	.745 18.92	.250 6.35	Hex.	.087 2.21	'Solderless Assembly, Hex Nut	408-08521	RF-ASMB-88 010-0003-0000
032-0098-0001	.745 18.92	.250 6.35	Hex.	.087 2.21	Hex Nut	408-08522	RF-ASMB-89 010-0003-0000
032-0155-0001	.700 17.78	.250 6.35	Hex.	.088 2.24	^{1,2} Hex Nut, .187 [4.75] Hex Cable Clamp Nut	408-08522	RF-ASMB-89 010-0003-0000
032-0156-0001	.700 17.78	.250 6.35	Dia.	.088 2.24	^{1,2} .187 [4.75] Hex Cable Clamp Nut	408-08522	RF-ASMB-89 010-0003-0000
052-0213-0001	.745 18.92	.250 6.35	Hex.	.087 2.21	'Solderless, Hex Nut w/ Safety Wire Holes, .021 [0.53] Wire Max.	408-08521	RF-ASMB-88 010-0003-0000
052-0235-0001	.745 18.92	.250 6.35	Hex.	.087 2.21	^{1,2} Hex Nut	408-08522	RF-ASMB-89 010-0003-0000
052-0235-0003	.745 18.92	.250 6.35	Hex.	.087 2.21	^{1,2} Hex Nut w/ Safety Wire Holes, .021 [0.53] Wire Max.	408-08522	RF-ASMB-89 010-0003-0000
052-0370-0001	.745 18.92	.250 6.35	Hex.	.093 2.36	'Hex Nut, Designed for Dual Shield Cable	408-08522	RF-ASMB-89 010-0003-0000
052-0542-0001	.745 18.92	.250 6.35	Hex.	.087 2.21	'Hex Nut	408-08522	RF-ASMB-89 010-0003-0000
S-70 Series (70 Ohm) .216 [5.49] -32 UNEF-2B Thread							
032-0010-0001	.760 19.30	.255 6.48	Dia.	.093 2.36	'Solderless Assembly	408-08521	RF-ASMB-88 010-0004-0000
032-0022-0001	.760 19.30	.255 6.48	Dia.	.093 2.36	¹	408-08525	RF-ASMB-95 010-0004-0000
032-0067-0001	.755 19.18	.255 6.48	Dia.	.108 2.74	¹	408-08522	RF-ASMB-89 010-0035-0000
032-0078-0001	.755 19.18	.255 6.48	Dia.	.108 2.74	'Solderless Assembly	408-08521	RF-ASMB-88 010-0035-0000
032-0222-0001	.760 19.30	.281 7.14	Hex.	.093 2.36	'Hex Nut w/ Safety Wire Holes, .014 [0.35] Wire Max.	408-08525	RF-ASMB-95 010-0004-0000
052-0092-0001	.760 19.30	.255 6.48	Dia.	.093 2.36	²	408-08525	RF-ASMB-95 010-0004-0000
S-93 Series (93 Ohm) .250 [6.35] -32 UNEF-2B Thread							
032-0011-0001	.760 19.30	.320 8.13	Dia.	.134 3.40	'Solderless Assembly	408-08521	RF-ASMB-88 010-0005-0000
032-0017-0001	.760 19.30	.320 8.13	Dia.	.134 3.40	¹	408-08525	RF-ASMB-95 010-0005-0000
032-0066-0001	.950 24.13	.350 8.89	Dia.	.154 3.91	'Silicone Bend Relief Cap	408-08523	RF-ASMB-90 —
032-0071-0001	.760 19.30	.320 8.13	Dia.	.134 3.40	'Cable Inner Conductor, .031 [0.78] Max.	408-08525	RF-ASMB-95 010-0005-0000
032-0092-0001	.760 19.30	.320 8.13	Dia.	.155 3.94	¹	408-08525	RF-ASMB-95 010-0044-0000
032-0099-0001	.760 19.30	.312 7.92	Hex.	.134 3.40	'Hex Nut	408-08525	RF-ASMB-95 010-0005-0000
052-0200-0001	.760 19.30	.312 7.92	Hex.	.134 3.40	'Hex Nut w/ Safety Wire Holes, .015 [0.38] Wire Max.	408-08525	RF-ASMB-95 010-0005-0000

¹Pin protected.

²Hole in ferrule permits soldering to clamp ring and shield for increased cable pullout strength.

Standard Connectors — Screw-On Series (Continued)

Right-Angle Plugs
S-50, 70 & 93

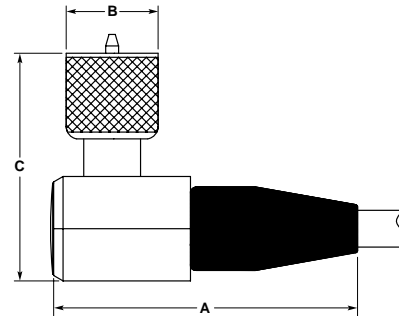
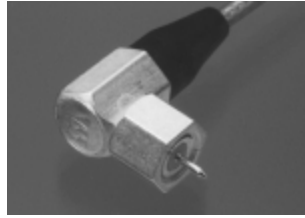

Part No.	Dim. A	Dim. B	Dim. C	Cable Jacket Max.	Special Features	Instruction Sheet No.	Former MICRODOT I.S. No.	Assembly Tool
S-50 Series (50 Ohm) .190 [4.83] -32 UNF-2B Thread								
032-0015-0001	.735 18.67	.225 5.72	Dia.	.570 14.48		408-08520	RF-ASMB-87	010-0016-0000
052-0204-0001	.735 18.67	.250 6.35	Hex.	.570 14.48	Hex Nut	408-08520	RF-ASMB-87	010-0016-0000
052-0215-0001	.735 18.67	.250 6.35	Hex.	.570 14.48	Hex Nut w/ Safety Wire Holes, .021 [.533] Wire Max.	408-08520	RF-ASMB-87	010-0016-0000
052-0337-0001	.745 18.92	.225 5.72	Dia.	.570 14.48		408-08520	RF-ASMB-87	010-0016-0000
S-70 Series (70 Ohm) .216 [5.49] -32 UNEF-2B Thread								
032-0013-0001	.745 18.92	.255 6.48	Dia.	.570 14.48		408-08520	RF-ASMB-87	010-0016-0000
052-0299-0001	.745 18.92	.281 7.14	Hex.	.570 14.48	Hex Nut w/ Safety Wire Holes, .014 [.355] Wire Max.	408-08520	RF-ASMB-87	010-0016-0000
052-0379-0001	.745 18.92	.281 7.14	Hex.	.570 14.48	Hex Nut	408-08520	RF-ASMB-87	010-0016-0000
S-93 Series (93 Ohm) .250 [6.35] -32 UNEF-2B Thread								
032-0014-0001	.745 18.92	.320 8.13	Dia.	.630 16.00		408-08520	RF-ASMB-87	010-0017-0000
032-0068-0001	.745 18.92	.320 8.13	Dia.	.630 16.00		408-08520	RF-ASMB-87	010-0017-0000
032-0153-0001	.745 18.92	.312 7.92	Hex.	.630 16.00	Hex Nut	408-08520	RF-ASMB-87	010-0017-0000
052-0207-0001	.745 18.92	.312 7.92	Hex.	.630 16.00	Hex Nut	408-08520	RF-ASMB-87	010-0017-0000
052-0298-0001	.745 18.92	.312 7.92	Hex.	.630 16.00	Hex Nut w/ Safety Wire Holes, .015 [.381] Wire Max.	408-08520	RF-ASMB-87	010-0017-0000
052-0304-0022	.745 18.92	.312 7.92	Hex.	.630 16.00	Hex Nut w/ Safety Wire Holes, .015 [.381] Wire Max., Silicone Bend Relief Cap	408-08520	RF-ASMB-87	010-0017-0000

Jacks

S-50, 70 & 93

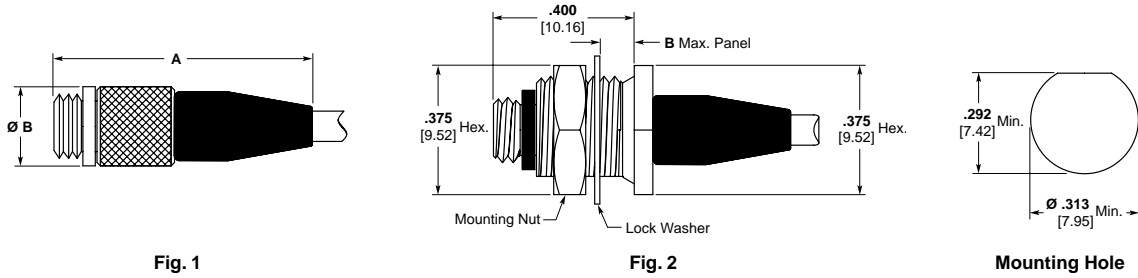

Part No.	Fig.	Dim. A	Dim. B	Cable Jacket Max.	Special Features	Instruction Sheet No.	Former MICRODOT I.S. No.	Assembly Tool
S-50 Series (50 Ohm) .190 [4.83] -32 UNF-2A Thread								
031-0033-0001	2	.870 22.10	.140 3.56	.088 2.24		408-08522	RF-ASMB-89	010-0003-0000
031-0034-0001	1	.750 19.05	.235 5.97	.087 2.21		408-08522	RF-ASMB-89	010-0003-0000
051-0467-0001	1	.720 18.30	.235 5.97	.079 2.01	Hex Collet Cable Clamp	408-08522	RF-ASMB-89	010-0003-0000
S-70 Series (70 Ohm) .216 [5.49] -32 UNEF-2A Thread								
031-0036-0001	1	.760 19.30	.255 6.48	.093 2.36		408-08522	RF-ASMB-89	010-0004-0000
031-0048-0001	2	.880 22.35	.140 3.56	.093 2.36		408-08525	RF-ASMB-95	010-0004-0000
031-0090-0001	1	.760 19.30	.255 6.48	.109 2.77		408-08522	RF-ASMB-89	010-0035-0000
S-93 Series (93 Ohm) .250 [6.35] -32 UNEF-2A Thread								
031-0032-0001	2	.880 22.35	.155 3.94	.134 3.40		408-08525	RF-ASMB-95	010-0005-0000
031-0037-0001	1	.760 19.30	.320 8.13	.134 3.40		408-08525	RF-ASMB-95	010-0005-0000
031-0088-0001	1	1.000 25.40	.320 8.13	.154 3.91		408-08533	RF-ASMB-106	—
031-0089-0001	2	.750 19.05	.140 3.56	.154 3.91	No Mounting Flat, Hex Nut Cable Clamp	408-08524	RF-ASMB-92	—

Standard Connectors — Screw-On Series (Continued)

Receptacles

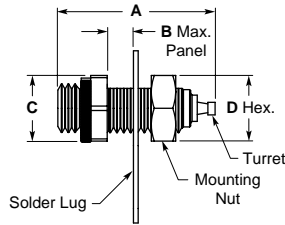

Fig. 1

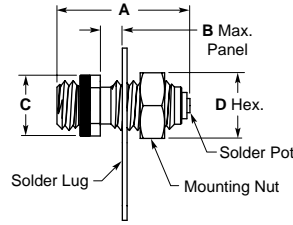
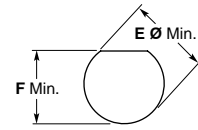

Fig. 2



Mounting Hole for Fig. 1 & 2

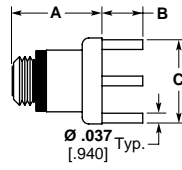

Fig. 3

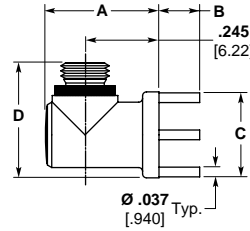
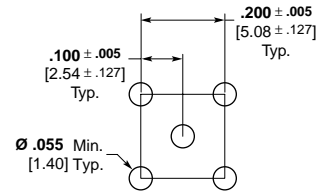

Fig. 4



Mounting Pattern for Fig. 3 & 4

Part No.	Fig.	Dim. A	Dim. B	Dim. C	Dim. D	Dim. E	Dim. F	Special Features	
S-50 Series (50 Ohm) .190 [4.83] -32 UNF-2A Thread									
031-0001-0001	2	.515 13.08	.080 2.03	.187 4.75	Wrench Flats	.250 6.35	.191 4.85	— No Mounting Flat	
031-0001-0003	2	.510 12.95	.110 2.80	.187 4.75	Wrench Flats	.250 6.35	.191 4.85	— No Mounting Flat	
031-0002-0001	2	.515 13.08	.150 3.81	.187 4.75	Wrench Flats	.250 6.35	.191 4.85	— No Mounting Flat	
031-0003-0001	2	.255 6.48	—	.187 4.75	Wrench Flats	—	.190 4.83	-32 — No Nut or Solder Lug, Threads into Panel	
031-0024-0001	2	.555 14.10	.120 3.05	.344 8.74	Wrench Flats	.438 11.13	.345 8.76	— Housing Isolated by Nylon Insulator	
031-0050-0001	1	.605 15.37	.160 4.06	.250 6.35	Hex.	.250 4.75	.191 4.85	.173 4.39	
031-0059-0001	3	.340 8.64	.155 3.93	.330 8.38	Dia.	—	—	—	
031-0061-0001	4	.425 10.80	.155 3.93	.330 8.38	Dia.	.480 12.20	—	—	
031-0062-0001	3	.345 8.76	.250 6.35	.330 8.38	Dia.	—	—	—	
051-0125-0001	2	.315 8.00	.125 3.18	.187 4.75	Wrench Flats	—	.138 3.50	— No Mounting Thread, Solder or Press into Panel	
051-0318-0001	1	.605 15.37	.160 4.06	.250 6.35	Hex.	.250 4.75	.191 4.85	.173 4.39	w/ Safety Wire Holes, .014 [.355] Wire Max.
051-0450-0001	3	.340 8.64	.050 1.27	.330 8.38	Dia.	—	—	—	
051-0459-0001	4	.425 10.80	.155 3.93	.330 8.38	Dia.	.480 12.20	—	—	3 Outer Legs
S-70 Series (70 Ohm) .216 [5.49] -32 UNEF-2A Thread									
031-0017-0001	2	.555 14.10	.100 2.54	.250 6.35	Hex.	.281 7.14	.217 5.51	— No Mounting Flat	
031-0018-0001	2	.555 14.10	.160 4.06	.250 6.35	Hex.	.281 7.14	.217 5.51	— No Mounting Flat	
031-0051-0001	1	.605 15.37	.160 4.06	.250 6.35	Hex.	.281 7.14	.217 5.51	.197 5.00	
031-0069-0001	3	.340 8.64	.155 3.94	.330 8.38	Dia.	—	—	—	
031-0072-0001	4	.425 10.80	.155 3.94	.330 8.38	Dia.	.480 12.20	—	—	

Receptacles (Continued)

Part No.	Fig.	Dim. A	Dim. B	Dim. C	Dim. D	Dim. E	Dim. F	Special Features
S-93 Series (93 Ohm) .250 [6.35] -32 UNEF-2A Thread								
031-0016-0001	2	.555 14.10	.100 2.54	.312 7.92	Hex.	.312 7.92	.251 6.38	— No Mounting Flat
031-0019-0001	2	.555 14.10	.160 2.54	.312 7.92	Hex.	.312 7.92	.251 6.38	— No Mounting Flat
031-0046-0001	2	.555 3.05	.120 3.05	.345 8.76	Wrench Flats	.438 11.13	.345 8.76	— Housing 0 by Nylon Insulator
031-0052-0001	1	.605 15.37	.160 2.54	.312 7.92	Hex.	.312 7.92	.251 6.38	.232 5.89
031-0067-0001	3	.340 8.64	.155 3.94	.330 8.38	Dia.	—	—	—
031-0073-0001	4	.425 10.80	.155 3.94	.330 8.38	Dia.	.480 12.20	—	—
031-0080-0001	3	.345 8.76	.250 6.35	.330 8.38	Dia.	—	—	—

All plugs shown below mate with all jacks/receptacles shown below.



Plug

SOS-50 Ohm Series	SOS-70 Ohm Series	SOS-93 Ohm Series
032-0055-0001	032-0060-0001	032-0077-0001
	032-0087-0001	032-0084-0001

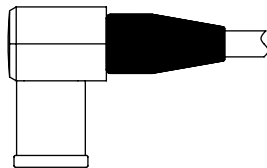

Right-Angle Plug

SOS-50 Ohm Series	SOS-70 Ohm Series	SOS-93 Ohm Series
032-0063-0001	032-0062-0001	032-0059-0001
		032-0083-0001

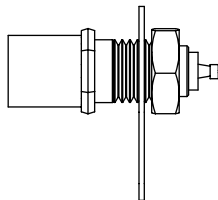

Plug Receptacle

SOS-50 Ohm Series	SOS-70 Ohm Series	SOS-93 Ohm Series
032-0042-0001	032-0042-0001	032-0042-0001
052-0061-0001	052-0061-0001	052-0061-0001
052-0471-0001	052-0471-0001	052-0471-0001

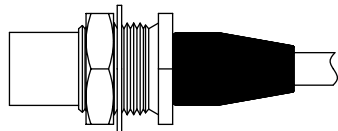

Bulkhead Plug

SOS-50 Ohm Series	SOS-70 Ohm Series	SOS-93 Ohm Series
032-0056-0001	032-0061-0001	032-0058-0001

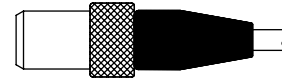

Jack

SOS-50 Ohm Series	SOS-70 Ohm Series	SOS-93 Ohm Series
031-0053-0001	031-0095-0001	031-0063-0001
		031-0093-0001

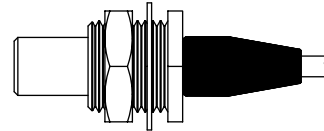

Bulkhead Jack

SOS-50 Ohm Series	SOS-70 Ohm Series	SOS-93 Ohm Series
031-0054-0001		031-0064-0001
		031-0094-0001

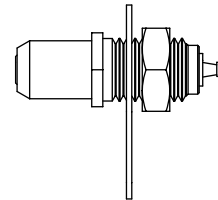

Receptacle

SOS-50 Ohm Series	SOS-70 Ohm Series	SOS-93 Ohm Series
031-0049-0001	031-0049-0001	031-0049-0001
051-0258-0001	051-0258-0001	051-0258-0001
051-0325-0001	051-0325-0001	051-0325-0001

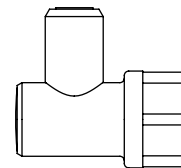

Right-Angle Printed Circuit Receptacle

SOS-50 Ohm Series	SOS-70 Ohm Series	SOS-93 Ohm Series
031-0070-0001	031-0070-0001	031-0070-0001

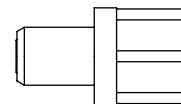

Printed Circuit Receptacle

SOS-50 Ohm Series	SOS-70 Ohm Series	SOS-93 Ohm Series
031-0060-0001	031-0060-0001	031-0060-0001
031-0065-0001	031-0065-0001	031-0065-0001

Straight Plugs

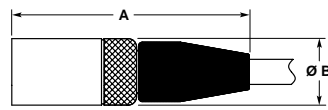
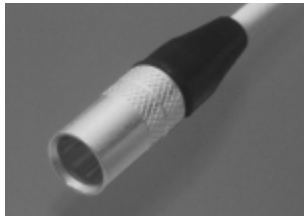

Fig. 1

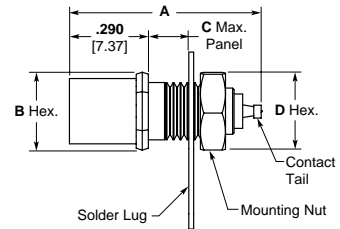

Fig. 2
Plug Receptacle

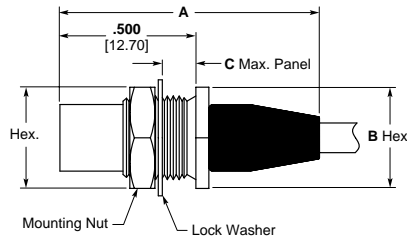
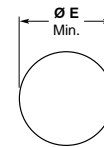

Fig. 3
Bulkhead Plug



Mounting Hole
for Fig. 2 & 3

Part No.	Fig.	Dim. A	Dim. B	Dim. C	Dim. D	Dim. E	Cable Max. Jacket	Special Features	Instruction Sheet No.	Former MICRODOT I.S. No.	Assembly Tool
SOS-50 Series (50 Ohm)											
032-0042-0001	2	.705 17.91	.250 6.35	.160 4.06	.281 7.14	.217 5.51	—	Turret Pin Contact Tail	—	—	—
032-0055-0001	1	.870 22.10	.250 6.35	—	—	—	.088 2.24	—	408-08526	RF-ASMB-97	010-0007-0000
032-0056-0001	3	.950 24.13	.375 9.53	.145 3.68	.375 9.53	.313 7.95	.088 2.24	—	408-08526	RF-ASMB-97	010-0007-0000
052-0061-0001	2	.750 19.05	.250 6.35	.160 4.06	.281 7.14	.217 5.51	—	Solder Pot Contact Tail	—	—	—
052-0471-0001	2	.590 14.99	.250 6.35	.095 2.41	.281 7.14	.217 5.51	—	Straight Pin Contact Tail ¹	—	—	—
SOS-70 Series (70 Ohm)											
032-0042-0001	2	.705 17.91	.250 6.35	.160 4.06	.281 7.14	.217 5.51	—	Turret Pin Contact Tail	—	—	—
032-0060-0001	1	.880 22.35	.250 6.35	—	—	—	.093 2.36	—	408-08529	RF-ASMB-102	010-0007-0000
032-0061-0001	3	.960 24.38	.375 9.53	.145 3.68	.375 9.53	.313 7.95	.093 2.36	—	408-08526	RF-ASMB-97	010-0007-0000
032-0087-0001	1	.880 22.35	.250 6.35	—	—	—	.108 2.24	—	408-08526	RF-ASMB-97	010-0036-0000
052-0061-0001	2	.750 19.05	.250 6.35	.160 4.06	.281 7.14	.217 5.51	—	Solder Pot Contact Tail	—	—	—
052-0471-0001	2	.590 14.99	.250 6.35	.095 2.41	.281 7.14	.217 5.51	—	Straight Pin Contact Tail ¹	—	—	—
SOS-93 Series (93 Ohm)											
032-0042-0001	2	.705 17.91	.250 6.35	.160 4.06	.281 7.14	.217 5.51	—	Turret Pin Contact Tail	—	—	—
032-0058-0001	3	.960 24.38	.375 9.53	.145 3.68	.375 9.53	.313 7.95	.134 3.40	—	408-08529	RF-ASMB-102	010-1008-0000
032-0077-0001	1	.880 22.35	.250 6.35	—	—	—	.134 3.40	—	408-08529	RF-ASMB-102	010-1008-0000
032-0084-0001	1	1.06 26.92	.250 6.35	—	—	—	.154 3.91	—	408-08523	RF-ASMB-90	—
052-0061-0001	2	.750 19.05	.250 6.35	.160 4.06	.281 7.14	.217 5.51	—	Solder Pot Contact Tail	—	—	—
052-0471-0001	2	.590 14.99	.250 6.35	.095 2.41	.281 7.14	.217 5.51	—	Straight Pin Contact Tail ¹	—	—	—

¹Lockwasher supplied in place of solder lug.

Jacks

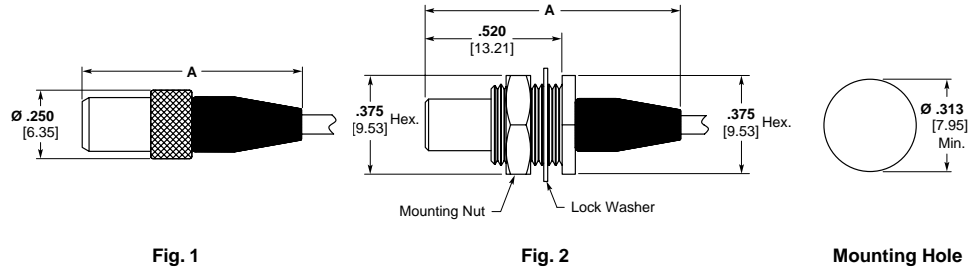

Part No.	Fig.	Dim. A	Cable Jacket Max.	Special Features	Instruction Sheet No.	Former MICRODOT I.S. No.	Assembly Tool
SOS-50 Series (50 Ohm)							
031-0053-0001	1	.800 20.32	.088 2.24		408-08531	RF-ASMB-104	010-0007-0000
031-0054-0001	2	.970 24.64	.088 2.24		408-08531	RF-ASMB-104	010-0007-0000
SOS-70 Series (70 Ohm)							
031-0095-0001	1	.810 20.57	.108 2.74		408-08531	RF-ASMB-104	010-0036-0000
SOS-93 Series (93 Ohm)							
031-0063-0001	1	.810 20.57	.134 3.40		408-08530	RF-ASMB-103	010-1008-0000
031-0064-0001	2	.980 24.89	.134 3.40		408-08530	RF-ASMB-103	010-1008-0000
031-0093-0001	1	1.100 27.94	.154 3.91	.305 [7.75] Dia. Over B.R. Cap	408-08532	RF-ASMB-105	—
031-0094-0001	2	.750 19.05	.154 3.91	Hex Nut Cable Clamp	408-08524	RF-ASMB-92	—

Right-Angle Plugs

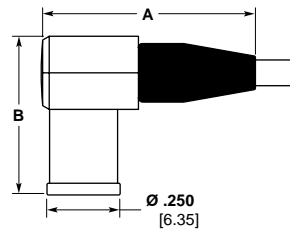

Part No.	Dim. A	Dim. B	Cable Max. O.D.	Special Features	Instruction Sheet No.	Former MICRODOT I.S. No.	Assembly Tool
SOS-50 Series (50 Ohm)							
032-0063-0001	.735 18.67	.545 13.84	.092 2.34		408-08520	RF-ASMB-87	010-0016-0000
SOS-70 Series (70 Ohm)							
032-0062-0001	.745 18.92	.545 13.84	.111 2.82		408-08520	RF-ASMB-87	010-0016-0000
SOS-93 Series (93 Ohm)							
032-0059-0001	.745 18.92	.605 15.37	.134 3.40		408-08520	RF-ASMB-87	010-0017-0000
032-0083-0001	.745 18.92	.605 15.37	.155 3.94		408-08520	RF-ASMB-87	010-0017-0000

Standard Connectors — Slide-On Series (Continued)

Receptacles

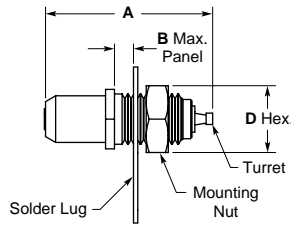

Fig. 1

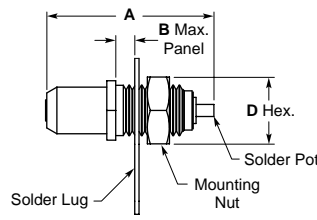
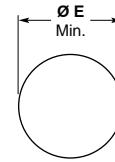

Fig. 2



Mounting Hole for Fig. 1 & 2

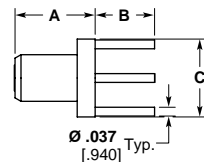

Fig. 3

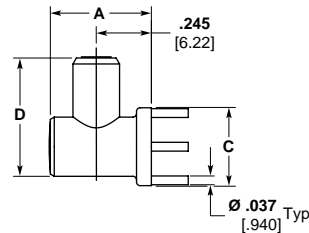
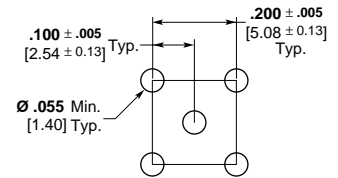

Fig. 4



Mounting Pattern for Fig. 3 & 4

Part No.	Fig.	Dim. A	Dim. B	Dim. C	Dim. D	Dim. E	Special Features
SOS-50 (50 Ohm), SOS-70 (70 Ohm), & SOS-93 (93 Ohm) Series							
031-0049-0001	1	.715 18.16	.160 4.06	.250 6.35 Hex.	.281 7.14	.217 5.51	
031-0060-0001	3	.340 8.64	.155 3.94	.330 8.38 Dia.	—	—	
031-0065-0001	3	.340 8.64	.250 6.35	.330 8.38 Dia.	—	—	
031-0070-0001	4	.425 10.79	.155 3.94	.330 8.38 Dia.	.540 13.72	—	
051-0258-0001	2	.715 18.16	.160 4.06	.250 6.35 Hex.	.281 7.14	.217 5.51	
051-0325-0001	1	.570 14.48	.140 3.56	.250 6.35 Hex.	—	.216-32 5.49 Thd.	No Nut or Lockwasher, Threads into Panel



Plug

QC-50 Ohm Series	QC-70 Ohm Series	QC-93 Ohm Series
032-0002-0001	032-0016-0001	032-0012-0001
032-0030-0001	032-0031-0001	032-0032-0001
	032-0079-0001	032-0072-0001



Jack

QC-50 Ohm Series	QC-70 Ohm Series	QC-93 Ohm Series
031-0038-0001		031-0040-0001

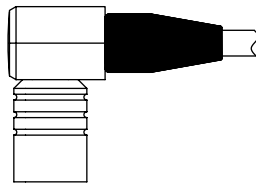

Right-Angle Plug

QC-50 Ohm Series	QC-70 Ohm Series	QC-93 Ohm Series
032-0026-0001	032-0027-0001	032-0020-0001
		052-0228-0001

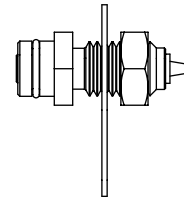

Receptacle

QC-50 Ohm Series	QC-70 Ohm Series	QC-93 Ohm Series
031-0057-0001	031-0057-0001	031-0058-0001
		031-0085-0001

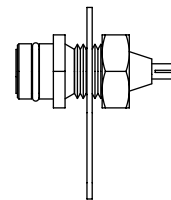

Receptacle

QC-50 Ohm Series	QC-70 Ohm Series	QC-93 Ohm Series
031-0004-0001	031-0004-0001	031-0020-0001
031-0005-0001	031-0005-0001	031-0021-0001
031-0006-0001	031-0006-0001	
051-0586-0001	051-0586-0001	

Straight Plugs

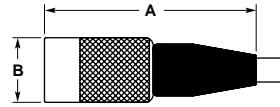

Part No.	Dim. A	Dim. B	Cable Jacket Max.	Special Features	Instruction Sheet No.	Former MICRODOT I.S. No.	Assembly Tool
QC-50 Series (50 Ohm)							
032-0002-0001	.820 20.83	.250 6.35	.093 2.36	Solderless Assembly	408-08527	RF-ASMB-100	010-0007-0000
032-0030-0001	.820 20.83	.250 6.35	.093 2.36		408-08526	RF-ASMB-97	010-0007-0000
QC-70 Series (70 Ohm)							
032-0016-0001	.830 21.08	.250 6.35	.093 2.36	Solderless Assembly	408-08527	RF-ASMB-100	010-0007-0000
032-0031-0001	.830 21.08	.250 6.35	.093 2.36		408-08529	RF-ASMB-102	010-0007-0000
032-0079-0001	.840 21.34	.250 6.35	.108 2.74		408-08526	RF-ASMB-97	010-0036-0000
QC-93 Series (93 Ohm)							
032-0012-0001	.845 21.46	.312 7.92	.134 3.40	Solderless Assembly	408-08527	RF-ASMB-100	010-0008-0000
032-0032-0001	.845 21.46	.312 7.92	.134 3.40		408-08529	RF-ASMB-102	010-0008-0000
032-0072-0001	1.050 26.67	.312 7.92	.154 3.91	Mates with 031-0085-0001 Only	408-08523	RF-ASMB-90	—

Right-Angle Plugs

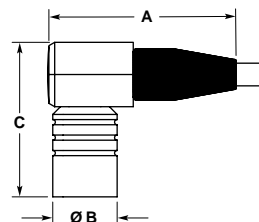

Part No.	Dim. A	Dim. B	Dim. C	Cable Jacket Max.	Special Features	Instruction Sheet No.	Former MICRODOT I.S. No.	Assembly Tool
QC-50 Series (50 Ohm)								
032-0026-0001	.735 18.67	.250 6.35	.605 15.37	.092 2.34		408-08520	RF-ASMB-87	010-0016-0000
QC-70 Series (70 Ohm)								
032-0027-0001	.745 18.92	.250 6.35	.605 15.37	.111 2.82		408-08520	RF-ASMB-87	010-0016-0000
QC-93 Series (93 Ohm)								
032-0020-0001	.745 18.92	.312 7.92	.635 16.13	.134 3.40		408-08520	RF-ASMB-87	010-0017-0000
052-0228-0001	.745 18.92	.312 7.92	.720 18.29	.155 3.94	Mates with 031-0085-0001 Only	408-08520	RF-ASMB-87	010-0017-0000

Jacks

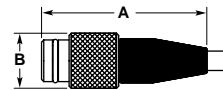

Part No.	Dim. A	Dim. B	Cable Jacket Max.	Special Features	Instruction Sheet No.	Former MICRODOT I.S. No.	Assembly Tool
QC-50 Series (50 Ohm)							
031-0038-0001	.750 19.05	.250 6.35	.093 2.36		408-08531	RF-ASMB-104	010-0007-0000
QC-93 Series (93 Ohm)							
031-0040-0001	.760 19.30	.320 8.13	.134 3.40		408-08530	RF-ASMB-103	010-1009-0000

Receptacles

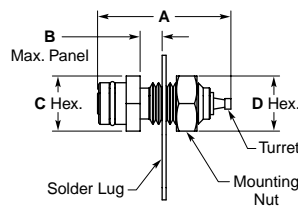

Fig. 1

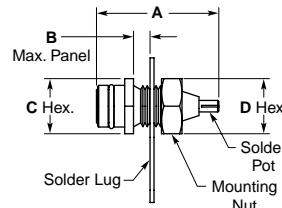
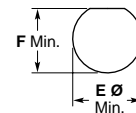

Fig. 2



Mounting Hole

Part No.	Fig.	Dim. A	Dim. B	Dim. C	Dim. D	Dim. E	Dim. F	Special Features
QC-50 Series (50 Ohm) & QC-70 Series (70 Ohm)								
031-0004-0001	2	.555 14.10	.095 2.41	.250 6.35	.250 6.35	.191 4.85	—	No Mounting Flat
031-0005-0001	2	.555 14.10	.165 4.19	.250 6.35	.250 6.35	.191 4.85	—	No Mounting Flat
031-0006-0001	2	.250 6.35	—	.250 6.35	—	.190-32 4.83 Thd	—	No Nut or Solder Lug, Threads into Panel
031-0057-0001	1	.605 15.37	.165 4.19	.250 6.35	.250 6.35	.191 4.85	.173 4.39	
051-0586-0001	2	.555 14.10	.165 4.19	.250 6.35	.250 6.35	.191 4.85	—	No Mounting Flat, Split Solder Lug
QC-93 Series (93 Ohm)								
031-0020-0001	2	.555 14.10	.095 2.41	.312 7.92	.312 7.92	.251 6.38	—	No Mounting Flat
031-0021-0001	2	.555 14.10	.165 4.19	.312 7.92	.312 7.92	.251 6.38	—	No Mounting Flat
031-0058-0001	1	.605 15.37	.160 4.06	.312 7.92	.312 7.92	.251 6.38	.232 5.89	
031-0085-0001	1	.715 18.16	.165 4.19	.312 7.92	.312 7.92	.251 6.38	—	No Mounting Flat, Mates with 032-0072-0001 & 052-0228-0001 Only

Standard Connectors — Twinax Series

Twinax Plugs: ☹️

For cables with two inner conductors and one shield

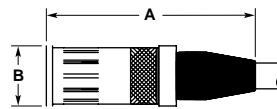

Fig. 1
Slide-On Series

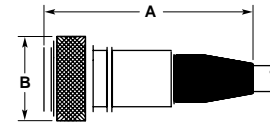

Fig. 2
Screw-On Series

Part No.	Fig.	Dim. A	Dim. B	Cable Jacket Max.	Special Features	Instruction Sheet No.	Former MICRODOT I.S. No.	Assembly Tool
032-0088-0001	1	1.085 27.56	.312 7.92	.167 4.24		408-08528	RF-ASMB-101	010-0031-0000
032-0093-0001	1	1.085 27.56	.312 7.92	.123 3.12		408-08528	RF-ASMB-101	010-0031-0000
052-0229-0001	2	1.085 27.56	.440 11.18	.123 3.12		408-08517	RF-ASMB-61	010-0172-0000
052-0324-0001	2	1.095 27.81	.440 11.18	.167 4.24		408-08517	RF-ASMB-61	010-0172-0000

Twinax Receptacles and Jacks: ☹️

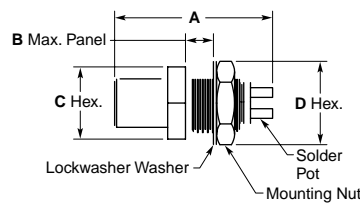

Fig. 1
Slide-On Series

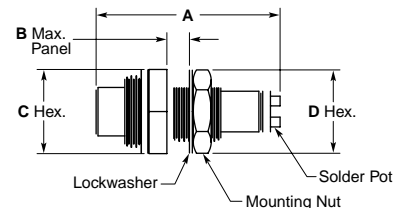

Fig. 2
Slide-On Series or Screw-On Series

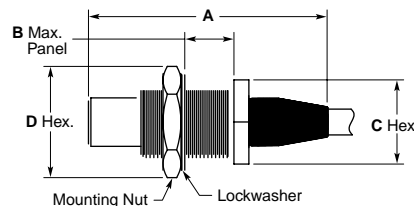
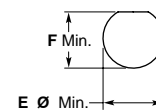

Fig. 3
Slide-On Series or Screw-On Series



Mounting Hole

Part No.	Fig.	Dim. A	Dim. B	Dim. C	Dim. D	Dim. E	Dim. F	Cable Max. Jacket	Special Features	Instruction Sheet No.	Former MICRODOT I.S. No.	Assembly Tool
031-0098-0001	1	.812 20.62	.155 3.94	.375 9.53	.375 9.53	.313 7.95	.292 7.42	—		—	—	—
051-0248-0001	2	.960 24.38	.155 3.94	.437 11.10	.375 9.53	.313 7.95	.292 7.42	—		—	—	—
051-0358-0001	3	1.060 26.92	.075 ¹ 1.91	.437 11.10	.500 12.7	.376 9.55	.351 8.92	.167 4.24	Lockwasher not included	408-08516	RF-ASMB-44	010-0186-0000
051-0389-0001	3	1.255 31.88	.255 ² 6.48	.437 11.10	.500 12.7	.376 9.55	.351 8.92	.167 4.24		408-08516	RF-ASMB-44	010-0186-0000

¹.075 [1.91] Max. Panel when mated with a Screw-On plug, .180 [4.57] Max. Panel when mated with a Slide-On plug.

².255 [6.48] Max. Panel when mated with a Screw-On plug, .360 [9.14] Max. Panel when mated with a Slide-On plug.

Standard Connectors — Triax Series and Terminals

Triax Plugs: 

For cables with one inner conductor and two isolated shields

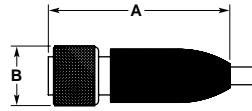

Part No.	Dim. A	Dim. B	Cable Jacket Max.	Special Features	Instruction Sheet No.	Former MICRODOT I.S. No.	Assembly Tool
052-0130-0001	1.37 34.80	.440 11.18 Dia.	.124 3.15		408-08514	RF-ASMB-20	—
052-0138-0001	1.37 34.80	.440 11.18 Dia.	.183 4.65		408-08515	RF-ASMB-21	—
052-0593-0001	1.37 34.80	.438 11.13 Hex.	.214 5.44	Hex Nut w/ Safety Wire Holes, .027 [.686] Wire Max.	408-08518	RF-ASMB-73	—

Triax Receptacle: 

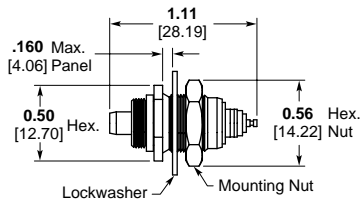

Part Number 051-0618-0001

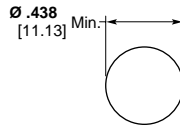

Mounting Hole

Triax Adapter: 

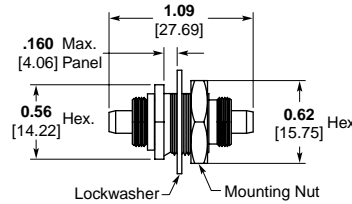

Part Number 053-0161-0001
Mates with Triax Plug, Both Ends

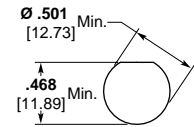

Mounting Hole

Terminals

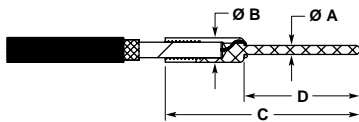

Fig. 1

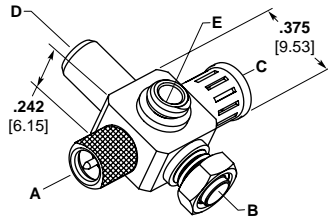

Fig. 2

Terminals are gold plated. See applicable MICRODOT drawing for solder and crimp instructions.

Part No.	Fig.	Dim. A	Dim. B	Dim. C	Dim. D	Cable Max. Dielectric	Cable Max. Inner Conductor
053-0354-0003	1	.030 .762	.080 2.03	.630 16.00	.375 9.53	.050 1.27	.015 .381
053-0249-0001	1	.030 .762	.105 2.67	.630 16.00	.375 9.53	.071 1.80	.021 .533
053-0495-0001	1	.030 .762	.125 3.18	.880 22.35	.610 15.49	.083 2.11	.022 .559
053-0656-0001	1	.030 .762	.145 3.68	.880 22.35	.375 9.53	.108 2.74	.023 .584
053-0294-0002	1	.030 .762	.145 3.68	.880 22.35	.625 15.88	.108 2.74	.023 .584
033-0115-0002	2	.040 1.02	.063 1.60	.255 6.48	.100 2.54	.042 1.07	.023 .584
033-0116-0001	2	.040 1.02	.094 2.39	.300 7.62	.100 2.54	.068 1.73	.023 .584
033-0117-0001	2	.040 1.02	.140 3.56	.350 8.89	.200 5.08	.108 2.74	.023 .584
053-0154-0001	1	.041 1.04	.080 2.03	.430 10.92	.175 4.45	.050 1.27	.019 .483
053-0250-0001	1	.041 1.04	.080 2.03	.505 12.83	.250 6.35	.050 1.27	.019 .483
053-0020-0003	1	.041 1.04	.080 2.03	.630 16.00	.375 9.53	.050 1.27	.015 .381
053-0021-0003	1	.041 1.04	.105 2.67	.630 16.00	.375 9.53	.071 1.80	.023 .584
053-0267-0003	1	.041 1.04	.105 2.67	.875 22.23	.625 15.88	.071 1.80	.023 .584
053-0265-0001	2	.041 1.04	.128 3.25	.505 12.83	.250 6.35	.102 2.59	.021 .533
053-0230-0001	2	.041 1.04	.128 3.25	.630 16.00	.375 9.53	.102 2.59	.018 .457
053-0155-0001	1	.041 1.04	.145 3.68	.430 10.82	.175 4.45	.108 2.74	.023 .584
053-0022-0003	1	.041 1.04	.145 3.68	.630 16.00	.375 9.53	.108 2.74	.023 .584
053-0388-0001	2	.042 1.07	.098 2.49	.500 12.70	.250 6.35	.065 1.65	.021 .533
053-0251-0001	2	.042 1.07	.098 2.49	.630 16.00	.375 9.53	.065 1.65	.021 .533

Standard Connectors — Module Blocks



The five faces of basic block can be used to mount any one of 10 different terminations. The 5 faces are coded with letters as shown above. The 10 terminations are coded with Nos. 1-10. Part number, to be complete, must show face location and termination Nos.

desired. (Ex: illustration shows 033-0042—A2—B7—C6—D5—E1) Ordering part number will be converted to a MICRODOT assigned number at time of ordering.

We do not stock complete assemblies.

Size	Part No.	Dim. H
50 Ohm	033-0042*	.250 6.35
70 Ohm	033-0043*	.250 6.35
93 Ohm	033-0044*	.300 7.62

*Part number to be completed by customer. A Computer Part Number will be assigned by Tyco Electronics.

Interfaces/Terminations

Termination Number	1	2	3	4	5	6
Mating Type	S	S	QC	QC	SOS	SOS
Description	Receptacle	Plug with Knurl Nut	Receptacle	Plug	Receptacle	Plug
	Thread	Thread Dia.		Dia.		Dia.
50 Series	.190-32 UNF 4.83	.190-32 UNF 4.83	.230 5.84	.250 6.35		.250 6.35
70 Series	.216-32 UNEF 5.49	.216-32 UNEF 5.49	.255 6.48	.250 6.35		.250 6.35
93 Series	.250-32 UNEF 6.35	.250-32 UNEF 6.35	.320 8.13	.312 7.92		.250 6.35

Interfaces/Terminations (Continued)

Termination Number	7	8	9	10					
Mating Type	—	—	S	S					
Description	Bulkhead Stud	Bulkhead Receptacle	Plug with Hex. Nut	Plug, Hex. Nut With Wire Holes					
	Thread	Thread Hex. Min. Hole Dia. Min. Hole Height	Thread Hex.	Thread Hex.					
50 Series	.190-32 UNF 4.83	.190-32 UNF 4.83	.250 6.35	.191 4.85	.173 4.39	.190-32 UNF 4.83	.250 6.35	.190-32 UNF 4.83	.250 6.35
70 Series	.190-32 UNF 4.83	.216-32 UNEF 5.49	.281 7.14	.217 5.51	.197 5.00	.216-32 UNEF 5.49	.281 7.14	.216-32 UNEF 5.49	.281 7.14
93 Series	.190-32 UNF 4.83	.250-32 UNEF 6.35	.312 7.92	.251 6.38	.232 5.89	.250-32 UNEF 6.35	.312 7.92	.250-32 UNEF 6.35	.312 7.92

Caps, Screw-On Series
For Receptacles and Jacks

Standard Connectors — Caps, Hoods

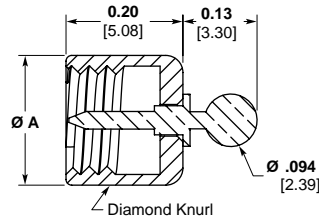

Fig. 1
With Grounding Pin

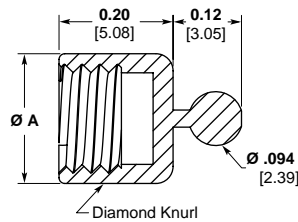

Fig. 2
Without Grounding Pin

Part No.	Fig.	Dim. A
S-50 Series		
033-0046-0001	1	.235 5.97
033-0056-0001	2	.235 5.97
S-70 Series		
033-0047-0001	1	.255 6.48
033-0057-0001	2	.255 6.48
S-93 Series		
033-0048-0001	1	.315 8.00
033-0058-0001	2	.315 8.00

Material — Brass per QQ-B-626

Finish — Silver plate per QQ-S-365, .0002 [.005] min.

Note: All caps can be supplied with .094 [2.39] Dia. bead chain and end ring. When ordering, specify chain length and end ring hole size (.130 [3.30], .140 [3.56], .167 [4.24], or .193 [4.90] Dia.)

Receptacle Hoods

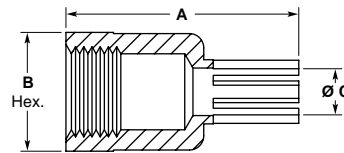

Part No.	Dim. A	Dim. B	Dim. C	Thread	For Receptacle Series
033-0067-0001	.490 12.45	.250 6.35	.098 2.49	.190-32 UNF 4.83	S-50, QC-50, QC-70
033-0068-0001	.490 12.45	.250 6.35	.114 2.90	.216-32 UNEF 5.49	S-70, SOS-50, SOS-70, SOS-93
033-0069-0001	.490 12.45	.312 7.92	.156 3.96	.250-32 UNEF 6.35	S-93, QC-93
033-0084-0001	.490 12.45	.250 6.35	.156 3.96	.216-32 UNEF 5.49	S-70, SOS-50, SOS-70, SOS-93
053-0147-0001	.840 21.34	.437 11.10	.156 3.96	.375-32 UNEF 9.53	—

Material — Brass per QQ-B-626

Finish — Silver plate per QQ-S-365, .0002 [.005] min.

Standard Connectors — Adapters

Feed-Thru Adapters for Screw-On Series

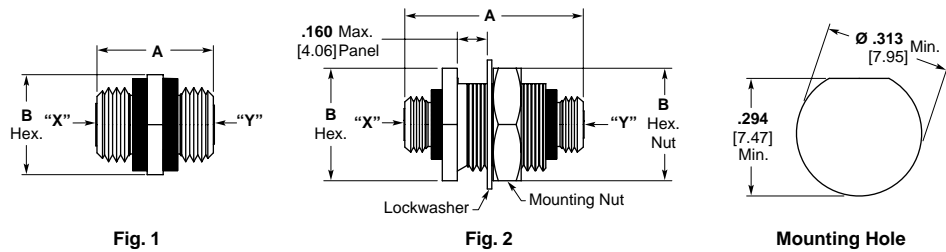

Part No.	Fig.	Dim. A	Dim. B	End "X" Is	End "Y" Is
033-0001-0001	1	.300 [7.62]	.250 [6.35]	S-50 Receptacle	S-50 Receptacle
033-0053-0001	2	.600 [15.24]	.375 [9.53]	S-50 Receptacle	S-50 Receptacle
033-0023-0001	1	.400 [10.16]	.250 [6.35]	S-70 Receptacle	S-70 Receptacle
033-0054-0001	2	.600 [15.24]	.375 [9.53]	S-70 Receptacle	S-70 Receptacle
033-0036-0001	1	.410 [10.41]	.312 [7.92]	S-93 Receptacle	S-93 Receptacle
033-0055-0001	2	.600 [15.24]	.375 [9.53]	S-93 Receptacle	S-93 Receptacle

BNC and TNC/MICRODOT Adapters for Screw-On, Slide-On, and Quick-Connect Series

For mating BNC/TNC connectors to MICRODOT standard connectors.

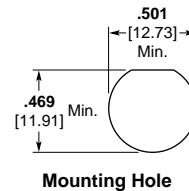

End "A" Is:	Configuration	End "B" Is:	50 Series Part No.	70 Series Part No.	93 Series Part No.
BNC Plug		Screw-On (S) Type Plug	033-0103-0001	033-0107-0001	033-0111-0001
BNC Plug		Screw-On Type Receptacle	033-0101-0001	033-0105-0001	033-0109-0001
BNC Receptacle		Screw-On (S) Type Plug	033-0104-0001	053-0108-0001	033-0112-0001
BNC Receptacle		Screw-On (S) Type Receptacle	033-0102-0001	033-0106-0001	033-0110-0001
BNC Bulkhead Receptacle		Screw-On (S) Type Plug	033-0127-0001 ¹	—	033-0129-0001 ¹

¹Mounting information: Housing Hex. .688 [17.48], Mtg. Nut Hex. .625 [15.88], Max. Panel .090 [2.29].

BNC and TNC/MICRODOT Adapters for Screw-On, Slide-On, and Quick-Connect Series (Continued)

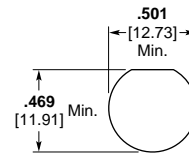

Mounting Hole

End "A" Is:	Configuration	End "B" Is:	50 Series Part No.	70 Series Part No.	93 Series Part No.
BNC Bulkhead Receptacle		Screw-On (S) Type Receptacle	033-0090-0001 ¹	033-0125-0001 ¹	033-0126-0001 ¹
TNC Plug		Screw-On (S) Type Receptacle	033-0141-0001	033-0143-0001	033-0145-0001
TNC Receptacle		Screw-On (S) Type Receptacle	033-0153-0001	—	—
BNC Plug		Slide-On (SOS) Type Plug	053-0339-0001	053-0339-0001	053-0339-0001
BNC Plug		Slide-On (SOS) Type Receptacle	033-0081-0001	033-0081-0001	033-0081-0001
BNC Receptacle		Slide-On (SOS) Type Plug	033-0092-0001	033-0092-0001	033-0092-0001
BNC Receptacle		Slide-On (SOS) Type Receptacle	033-0082-0001	033-0082-0001	033-0082-0001
BNC Bulkhead Receptacle		Slide-On (SOS) Type Receptacle	033-0124-0001 ¹	033-0124-0001 ¹	033-0124-0001 ¹
BNC Plug		Quick-Connect (QC) Type Receptacle	033-0093-0001	033-0093-0001	033-0097-0001
BNC Receptacle		Quick-Connect (QC) Type Receptacle	033-0094-0001	033-0094-0001	—

¹Mounting information: Housing Hex. .688 [17.48], Mtg. Nut Hex. .625 [15.88], Max. Panel .090 [2.29].

Performance Data

Summary

For Gold Plated Crimp Style Coaxial Connectors

Coaxial Connectors

Gold Plated Crimp Style Coaxial Connectors

Mechanical

Captive Contacts — Terminated connector contacts captivated from movement in both directions.

Cable Retention

50 Ohm connectors, 15 lb. min.
70 Ohm connectors, 25 lb. min.
93 Ohm connectors, 25 lb. min.

Recommended Coupling Torque (Threaded Interface)

8 inch/pounds max. [.904 Nm]

Recommended Receptacle Mounting Torque (Threaded Interface)

8 inch/pounds max. [.904 Nm]

Contact Protection (Unmated)

Pin contact protected by coupling nut. Socket protected by insulator and housing.

Assembly Methods

Straight Plugs & Jacks — Cable Inner Conductor: Crimped to contact. Cable Shield: Crimped under housing.

Right-Angle Plugs — Cable Inner Conductor: Crimped to contact. Cable Shield: Crimped under housing.

Environmental

Temperature Range (Continuous Service) — -80°F to +392°F. [-62°C to +200°C].

Vibration^{1,2} — MIL-STD-202, Method 204, Test condition B (15 G peak). No physical damage or electrical discontinuities in excess of 1 microsecond.

Shock^{1,2} — MIL-STD-202, Method 213, Test Condition H. No physical damage or electrical discontinuity after shock.

Thermal Shock — MIL-STD-202, Method 107, Test Condition C.

Moisture Resistance¹ — MIL-STD-202, Method 106.

Salt Spray¹ — MIL-STD-202, Method 101, Test Condition B (48 hours).

Electrical

Impedance — Designed to be compatible with 50, 70, or 93 Ohm miniature coaxial cable.

Dielectric Withstanding Voltage — 1000 volts RMS at sea level.

Contact Resistance — 4 milliohms max., D.C.

Contact Capacity — 3 amps, D.C.

Insulation Resistance — 5×10^3 Megohms min. @ 500 volts D.C.

Voltage Standing Wave Ratio³ (VSWR) — Typical 50 Ohm series, 1.2 max. to 2 GHz.

Materials

Housing, Nut, Inner Sleeve — Brass per ASTM-B-16, 35% Zinc.

Insulator — TEFLON per ASTM-D-1710.

Pin & Socket Contacts — Beryllium Copper per ASTM-B-196.

Middle Sleeve — Copper Alloy.

Facial Seal⁴, Sealing Sleeve & Gasket — Silicone Rubber per ZZ-R-765.

Lockwasher — #425 Bronze Alloy.

Plating

Contacts, Housing, Nut, Inner Sleeve, Middle Sleeve, Lockwasher — Gold per MIL-G-45204, Type II, Grade C, Class 1.

NOTES:

¹Screw-On Series threaded interface.

²Tyco Electronics recommends the use of wired connectors in vibration and shock environments. See individual specifications for connectors with wire holes.

³VSWR is a system specification. Where performance is critical, purchase Tyco Electronics cable assemblies (See page 7105) and specify VSWR testing and mating connector part numbers.

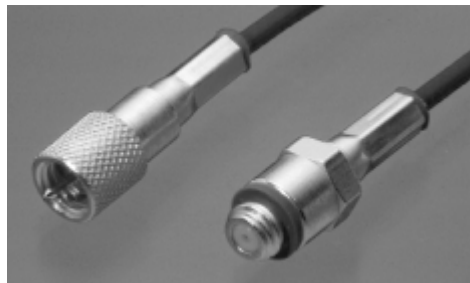

Gold Plated Crimp Style Coaxial Connectors — Screw-On Series

Straight Plugs

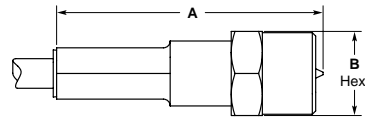

Fig. 1
Partial Hex. Nut

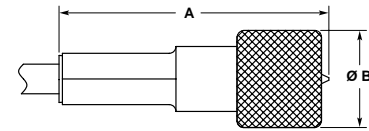

Fig. 2
Knurl Nut

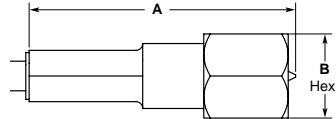

Fig. 3
Full Hex. Nut

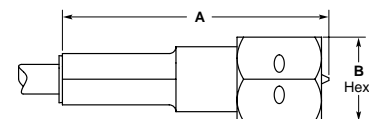

Fig. 4
Hex. Nut w/ 3 Safety Wire Holes

Part No.	Fig.	Dim. A	Dim. B	Cable Max.	Special Features	Instruction Sheet No.	Former MICRODOT I.S. No.
50 Ohm Series .190 [4.83] -32 UNF-2B Thread							
132-0112-0001	1	.800 20.32	.250 6.35	.088 2.24		408-08508	RF-ASMB-8
132-0112-0002	2	.800 20.32	.250 6.35	.088 2.24		408-08508	RF-ASMB-8
132-0112-0003	3	.800 20.32	.250 6.35	.088 2.24		408-08508	RF-ASMB-8
132-0112-0004	4	.800 20.32	.250 6.35	.088 2.24		408-08508	RF-ASMB-8
132-0113-0001	1	.800 20.32	.250 6.35	.088 2.24	With environmental seal	408-08508	RF-ASMB-8
132-0113-0002	2	.800 20.32	.250 6.35	.088 2.24	With environmental seal	408-08508	RF-ASMB-8
132-0113-0003	3	.800 20.32	.250 6.35	.088 2.24	With environmental seal	408-08508	RF-ASMB-8
132-0113-0004	4	.800 20.32	.250 6.35	.088 2.24	With environmental seal	408-08508	RF-ASMB-8
132-0114-0001	1	.800 20.32	.250 6.35	.110 2.79		408-08508	RF-ASMB-8
132-0114-0002	2	.800 20.32	.250 6.35	.110 2.79		408-08508	RF-ASMB-8
132-0114-0003	3	.800 20.32	.250 6.35	.110 2.79		408-08508	RF-ASMB-8
132-0114-0004	4	.800 20.32	.250 6.35	.110 2.79		408-08508	RF-ASMB-8
132-0115-0001	1	.800 20.32	.250 6.35	.110 2.79	With environmental seal	408-08508	RF-ASMB-8
132-0115-0002	2	.800 20.32	.250 6.35	.110 2.79	With environmental seal	408-08508	RF-ASMB-8
132-0115-0003	3	.800 20.32	.250 6.35	.110 2.79	With environmental seal	408-08508	RF-ASMB-8
132-0115-0004	4	.800 20.32	.250 6.35	.110 2.79	With environmental seal	408-08508	RF-ASMB-8
132-0509-0002	2	.800 20.32	.250 6.35	.116 2.95	Dual shield cable version of RG 188 & 316	408-08508	RF-ASMB-8
70 Ohm Series .216 [5.49] -32 UNEF-2B Thread							
132-0200-0001	1	.800 20.32	.281 7.14	.110 2.79		408-08508	RF-ASMB-8
132-0200-0002	2	.800 20.32	.290 7.37	.110 2.79		408-08508	RF-ASMB-8
132-0200-0003	3	.800 20.32	.281 7.14	.110 2.79		408-08508	RF-ASMB-8
132-0200-0004	4	.800 20.32	.281 7.14	.110 2.79		408-08508	RF-ASMB-8
132-0201-0001	1	.800 20.32	.281 7.14	.110 2.79	With environmental seal	408-08508	RF-ASMB-8
132-0201-0002	2	.800 20.32	.290 7.37	.110 2.79	With environmental seal	408-08508	RF-ASMB-8
132-0201-0003	3	.800 20.32	.281 7.14	.110 2.79	With environmental seal	408-08508	RF-ASMB-8
132-0201-0004	4	.800 20.32	.281 7.14	.110 2.79	With environmental seal	408-08508	RF-ASMB-8

Straight Plugs (Continued)

Part No.	Fig.	Dim. A	Dim. B	Cable Max.	Special Features	Instruction Sheet No.	Former MICRODOT I.S. No.
93 Ohm Series .250 [6.35] -32 UNEF-2B Thread							
132-0300-0001	1	.795 20.19	.312 7.92	.155 3.94		408-08508	RF-ASMB-8
132-0300-0002	2	.795 20.19	.320 8.13	.155 3.94		408-08508	RF-ASMB-8
132-0300-0003	3	.795 20.19	.312 7.92	.155 3.94		408-08508	RF-ASMB-8
132-0300-0004	4	.795 20.19	.312 7.92	.155 3.94		408-08508	RF-ASMB-8
132-0301-0001	1	.795 20.19	.312 7.92	.155 3.94	With environmental seal	408-08508	RF-ASMB-8
132-0301-0002	2	.795 20.19	.320 8.13	.155 3.94	With environmental seal	408-08508	RF-ASMB-8
132-0301-0003	3	.795 20.19	.312 7.92	.155 3.94	With environmental seal	408-08508	RF-ASMB-8
132-0301-0004	4	.795 20.19	.312 7.92	.155 3.94	With environmental seal	408-08508	RF-ASMB-8

Right-Angle Plugs

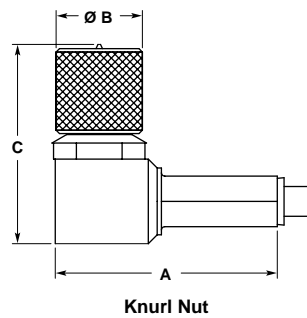

Part No.	Dim. A	Dim. B	Dim. C	Cable Jacket Max.	Special Features	Instruction Sheet No.	Former MICRODOT I.S. No.
50 Ohm Series .190 [4.83] -32 UNF-2B Thread							
132-0116-0002	.660 16.76	.250 6.35	.620 15.75	.088 2.24		408-08509	RF-ASMB-11
132-0117-0002	.660 16.76	.250 6.35	.620 15.75	.088 2.24	With environmental seal	408-08509	RF-ASMB-11
132-0118-0002	.695 17.65	.250 6.35	.650 16.51	.110 2.79		408-08509	RF-ASMB-11
132-0119-0002	.695 17.65	.250 6.35	.650 16.51	.110 2.79	With environmental seal	408-08509	RF-ASMB-11
70 Ohm Series .216 [5.49] -32 UNEF-2B Thread							
132-0202-0002	.695 17.65	.290 7.37	.650 16.51	.110 2.79		408-08509	RF-ASMB-11
132-0203-0002	.695 17.65	.290 7.37	.650 16.51	.110 2.79	With environmental seal	408-08509	RF-ASMB-11
93 Ohm Series .250 [6.35] -32 UNEF-2B Thread							
132-0302-0002	.710 18.03	.320 8.13	.680 17.27	.155 3.94		408-08509	RF-ASMB-11
132-0303-0002	.710 18.03	.320 8.13	.680 17.27	.155 3.94	With environmental seal	408-08509	RF-ASMB-11

Gold Plated Crimp Style Coaxial Connectors — Screw-On Series (Continued)

Jacks

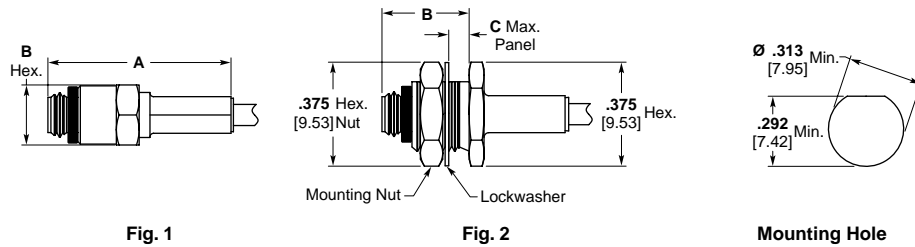

Part No.	Fig.	Dim. A	Dim. B	Dim. C	Cable Jacket Max.	Special Features	Instruction Sheet No.	Former MICRODOT I.S. No.
50 Ohm Series .190 [4.83] -32 UNF-2B Thread								
131-0134-0001	1	.770 19.56	.250 6.35	—	.088 2.24		408-08508	RF-ASMB-8
131-0135-0001	2	.770 19.56	.360 9.14	.105 2.67	.088 2.24		408-08508	RF-ASMB-8
131-0136-0001	1	.770 19.56	.250 6.35	—	.110 2.79		408-08508	RF-ASMB-8
131-0137-0001	2	.770 19.56	.360 9.14	.105 2.67	.110 2.79		408-08508	RF-ASMB-8
131-0150-0001	1	.770 19.56	.250 6.35	—	.116 2.95	Dual Shield Cable Version of RG 188 & 316	408-08508	RF-ASMB-8
131-0151-0001	2	.770 19.56	.360 9.14	.105 2.67	.116 2.95	Dual Shield Cable Version of RG 188 & 316	408-08508	RF-ASMB-8
70 Ohm Series .216 [5.49] -32 UNEF-2B Thread								
131-0200-0001	1	.770 19.56	.281 7.14	—	.110 2.79		408-08508	RF-ASMB-8
131-0201-0001	2	.770 19.56	.360 9.14	.100 2.54	.110 2.79		408-08508	RF-ASMB-8
93 Ohm Series .250 [6.35] -32 UNEF-2B Thread								
131-0300-0001	1	.760 19.30	.312 7.92	—	.155 3.94		408-08508	RF-ASMB-8
131-0301-0001	2	.760 19.30	.350 8.89	.095 2.41	.155 3.94		408-08508	RF-ASMB-8

Gold Plated Crimp Style Coaxial Connectors — Screw-On Series (Continued)

Receptacles

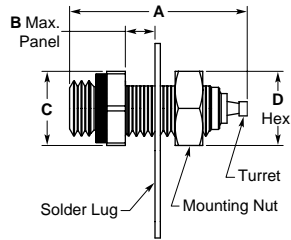

Fig. 1

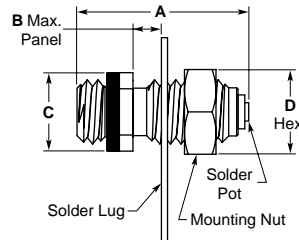
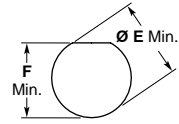

Fig. 2



Mounting Hole for Fig. 1 & 2

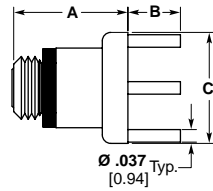

Fig. 3

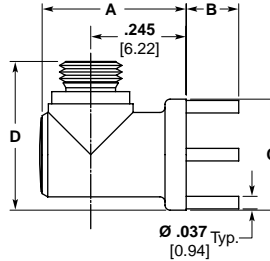
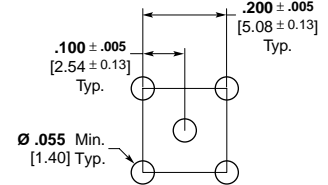

Fig. 4



Mounting Pattern for Fig. 3 & 4

Part No.	Fig.	Dim. A	Dim. B	Dim. C	Dim. D	Dim. E	Dim. F	Special Features
50 Ohm Series .190 [4.83] -32 UNF-2A Thread								
131-0138-0002	1	.605 15.37	.160 4.06	.250 6.35 Hex.	.250 6.35	.191 4.85	.173 4.39	
131-0139-0002	2	.515 13.08	.150 3.81	.187 4.75 Wrench Flats	.250 6.35	.191 4.85	—	No Mounting Flat
131-0140-0001	2	.255 6.48	—	.187 4.75 Wrench Flats	—	.190 4.83 -32 Thd.	—	No Nut or Solder Lug, Threads into Panel
131-0141-0002	3	.340 8.64	.155 3.94	.330 8.38 Dia.	—	—	—	
131-0142-0002	4	.425 10.80	.155 3.94	.330 8.38 Dia.	.480 12.19	—	—	
70 Ohm Series .216 [5.49] -32 UNEF-2A Thread								
131-0202-0002	1	.605 15.37	.160 4.06	.250 6.35 Hex.	.281 7.14	.217 5.51	.197 5.00	
131-0705-0001	3	.340 8.64	.155 3.94	.330 8.38 Dia.	—	—	—	
93 Ohm Series .250 [6.35] -32 UNEF-2A Thread								
131-0303-0002	3	.340 8.64	.155 3.94	.330 8.38 Dia.	—	—	—	
131-0304-0001	4	.425 10.80	.155 3.94	.330 8.38 Dia.	.480 12.19	—	—	
131-0904-0001	1	.605 15.37	.160 4.06	.312 7.92 Hex.	.312 7.92	.251 6.38	.232 5.89	

Gold Plated Crimp Style Coaxial Connectors Assembly Tools

Table 1. Contact Crimp Tools

MICRODOT Part No.	Manufacturers Part No.
010-0065-0000	Astro Tool A-810-3

Table 2. Housing Crimp Tools

MICRODOT Part No.	Thomas & Betts Part No.	Max. Cable Diameter
010-0081-0000	WT-400	.088 [2.24]
010-0082-0000	WT-402	.110 [2.79]
010-0083-0000	WT-406	.155 [3.94]

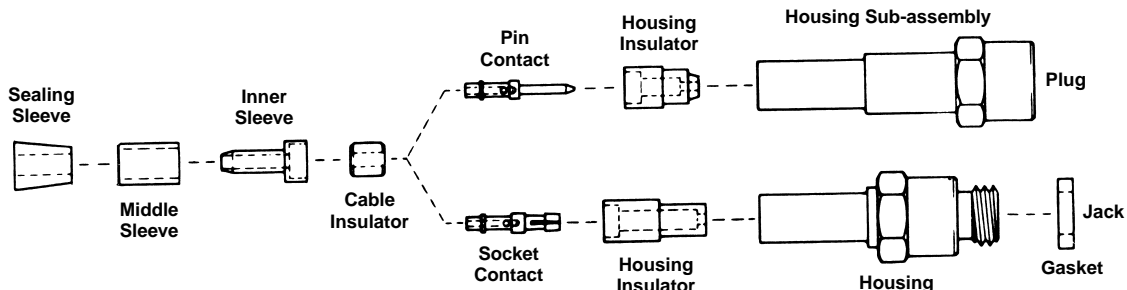

LEPRA/CON Ultra-Miniature Connectors

Performance Data Summary
For LEPRA/CON Connectors

Mechanical

Captive Contacts — Terminated connector contacts captivated from movement in both directions.

Cable Retention — 10 lb. min. when properly assembled to RG196/U and RG178/U cable.

Recommended Coupling Torque (Threaded Interface) — 24 inch/ounces max.

Recommended Receptacle Mounting Torque (All Series) — 24 inch/ounces max.

Typical Cable Acceptance Dimensions — Inner conductor: .012 [0.31] nom. Dielectric: .039 [0.99] max. Shield: .059 [1.50] max. Jacket: .081 [2.06] max.

Contact Protection (Unmated) — Twist pin contact protected from damage by insulator. Tube socket protected by connector housing.

Assembly Methods

Straight Plugs & Jacks — Cable Inner Conductor: Crimped to contact. Cable Shield: Crimped under housing.

Right-Angle Plugs — Cable Inner Conductor: Soldered to contact. Cable Shield: Crimped under housing.

Environmental

Temperature Range (Continuous Service) — -85°F to +392°F [-65°C to +200°C].

Vibration^{1,2} — MIL-STD-202, Method 204, Test Condition B (15 G peaks). No physical damage or electrical discontinuities in excess of 1 microsecond.

Shock^{1,2} — MIL-STD-202, Method 213, Test Condition H. No physical damage or electrical discontinuity after shock.

Thermal Shock — MIL-STD-202, Method 107, Test Condition C.

Moisture Resistance¹ — MIL-STD-202, Method 106.

Salt Spray¹ — MIL-STD-202, Method 101, Test Condition B (48 hours).

Electrical

Impedance — Designed to be compatible with 50 Ohm coaxial cable RG178/U.

Dielectric Withstanding Voltage — 450 volts RMS at sea level, 250 volts RMS at 50,000 ft [15,240 m], 150 volts RMS at 70,000 ft. [21,336 m]

Contact Resistance — 8 milliohms max., D.C.

Contact Capacity — 3 amps, D.C.

Insulation Resistance — 10⁹ Megohms min. @ 500 volts D.C.

Voltage Standing Wave Ratio³ (VSWR) — Typical 50 Ohm Series, 1.2 Maximum to 2 GHz.

Materials

Housing, Nut, Ferrule — Brass per ASTM-B-16.

Insulator — TEFLON per ASTM-D-1710.

Pin & Socket Contact — Copper Alloy.

Crimp Sleeve — Copper Alloy.

Lockwasher — #425 Bronze Alloy.

Plating

Contacts, Housing, Nut, Ferrule, Crimp Sleeve, Lockwasher — Gold per MIL-G-45204, Type II, Grade C, Class 1.

Notes:

¹Screw-On Series, threaded interface.

²Tyco Electronics recommends the use of safety wired connectors in vibration and shock environments. See individual specifications with wire holes.

³VSWR is a system specification. Where performance is critical, purchase Tyco Electronics cable assemblies with Screw-On connectors (See page 7105) and specify VSWR testing and mating connector part numbers.

LEPRA/CON Ultra-Miniature Connectors — Screw-On Series

Featuring Twist Pin, Pin and Socket Contacts, Standard Interface



MICRODOT twist pin, pin and socket contacts are used in LEPRA/CON connectors. Twist pin contact pins are produced from beryllium copper material with a gold-plated finish and constructed with helically-wound stress free cable of spring copper around a highly conductive soft copper core, terminated with a hemispherical weld. Twist pin

contacts contain seven self-wiping spring surfaces, designed for consistent continuity and very low noise level. Twist pin contacts are self-aligning because of the contact-engaging-end configuration. The sockets are a closed entry tubular-type contact, made of gold-plated copper alloy.

The connectors are designed to be used with coaxial cables RG196/U and RG178/U.

The connectors are designed with the contacts completely protected for reliability. The use of twist pin contacts makes the connectors very rugged for their size.

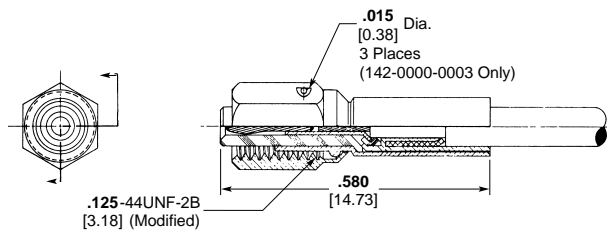

Straight Plugs¹

Part No.	Nut Style
142-0000-0001	.156 [3.96] Hex.
142-0000-0002	.160 [4.06] Dia. Knurl
142-0000-0003	.156 [3.96] Hex. w/ Safety Wire Holes

Assembly instructions: RF-ASMB-12

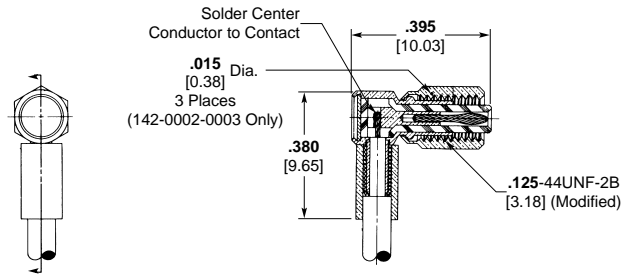

Right-Angle Plug¹

Part No.	Nut Style
142-0002-0001	.156 [3.96] Hex.
142-0002-0002	.160 [4.06] Dia. Knurl
142-0002-0003	.156 [3.96] Hex. w/ Safety Wire Holes

Assembly instructions: RF-ASMB-13

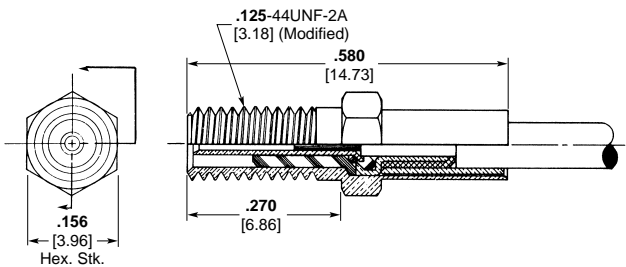

Jack¹

Part Number 141-0000-0001
Instruction Sheet Number 408-08510
Former MICRODOT I.S. Number RF-ASMB-12

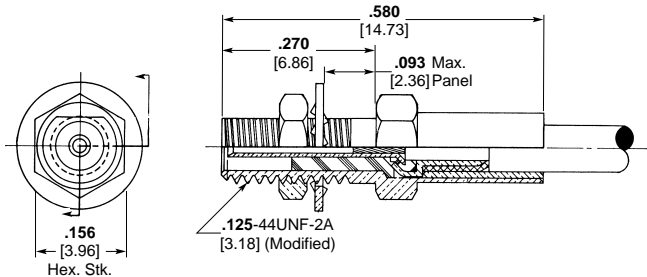

Bulkhead Jack¹

Part Number 141-0001-0001
Instruction Sheet Number 408-08510
Former MICRODOT I.S. Number RF-ASMB-12

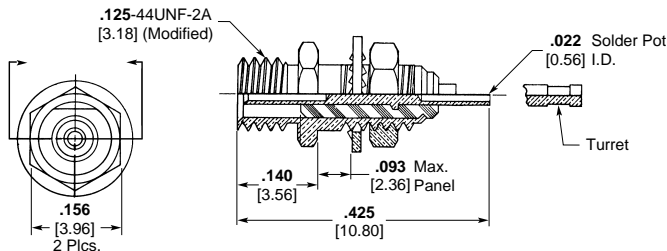

Front Mount Receptacle¹

Part No.	Contact Tail
141-0002-0001	Turret
141-0002-0002	Solder Pot

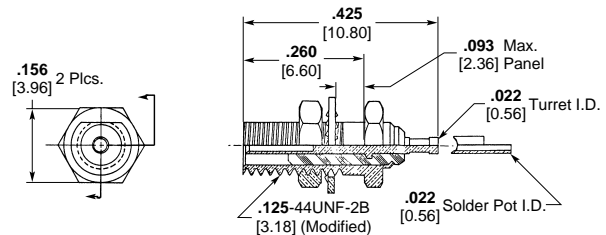

Rear Mount Receptacle¹

Part No.	Contact Tail
141-0003-0001	Turret
141-0003-0002	Solder Pot

¹Mounting hole pattern and assembly tools shown on page 7101.

Featuring Twist Pin,
Pin and Socket Contacts,
Standard Interface (Continued)

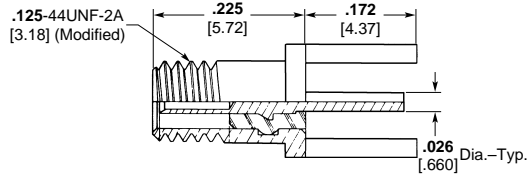

Straight Printed Circuit Receptacle¹
Part No. 141-0004-0001

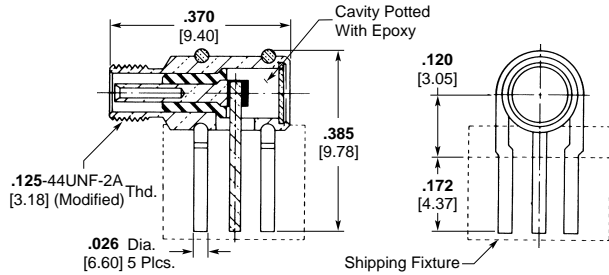

Right-Angle Printed Circuit Receptacle¹
(Small Mounting Pattern)
Part Number 141-0019-0001

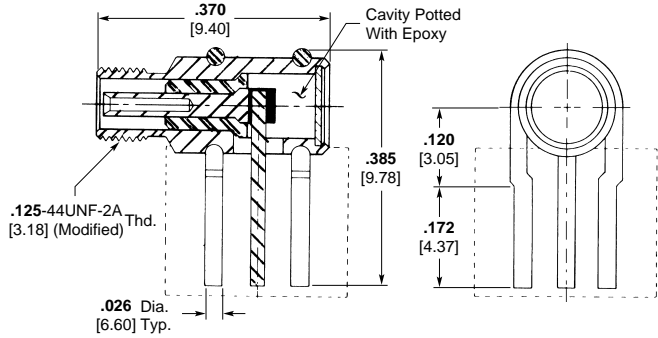

Right-Angle Printed Circuit Receptacle¹
(Standard Mounting Pattern)
Part Number 141-0010-0001

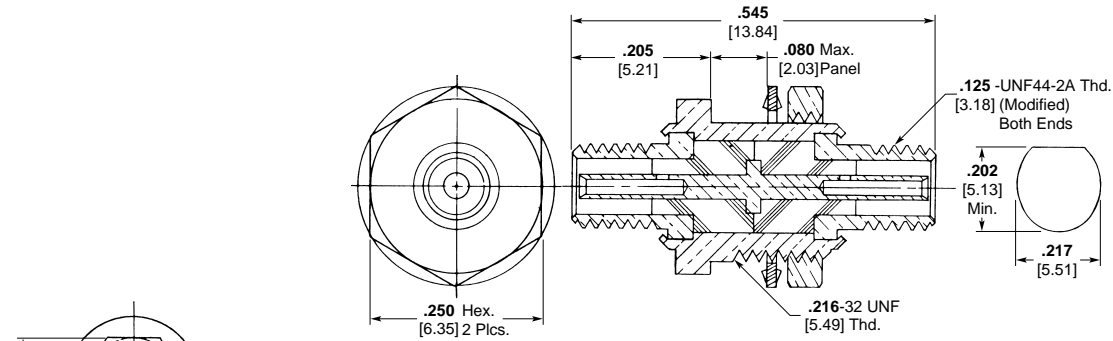

Feed-Thru Bulkhead Adapter
(Both Ends are Receptacle Interface)
Part Number 143-0005-0001

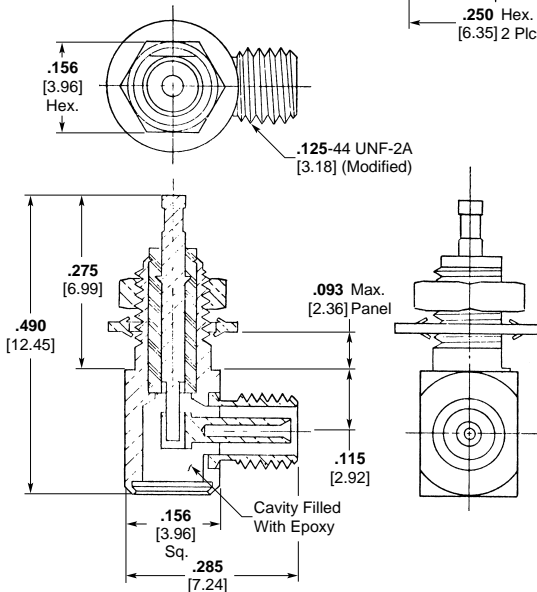

Right-Angle Receptacle¹
Part Number 141-0013-0001

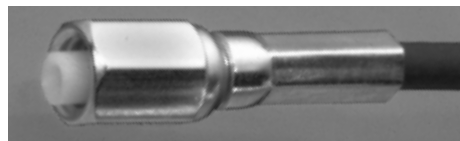

Straight Plug

¹Mounting hole pattern and assembly tools shown on page 7101.

LEPRA/CON Ultra-Miniature Connectors — Screw-On Series (Continued)

Featuring Twist Pin, Pin and Socket Contacts with Locking Interface

The MICRODOT LEPRA/CON coaxial connector series is now offered with a unique locking interface feature. This new coupling design permits the user to lock the coaxial plug, when mated to its receptacle, preventing any axial rotation. This

adaptation is especially popular on connector installations requiring straight or 90° cable terminations firmly held in a fixed position. The locking interface is especially suited for telecommunications and instrumentation applications. This

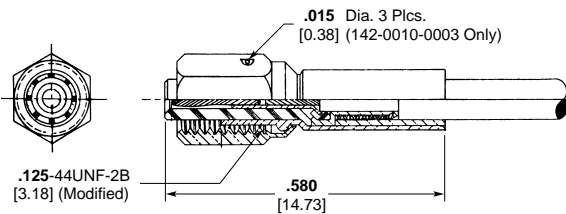

Straight Plug¹

Part No.	Nut Style
142-0010-0001	.156 [3.96] Hex.
142-0010-0002	.160 [4.06] Dia. Knurl
142-0010-0003	.156 [3.96] Hex. w/ Safety Wire Holes

Assembly instructions: RF-ASMB-12, 142-0010-0001

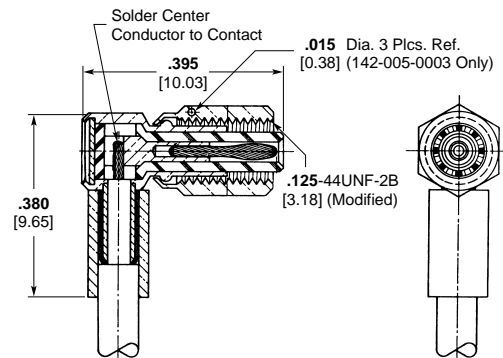

Right-Angle Plug¹

Part No.	Nut Style
142-0005-0001	.156 [3.96] Hex.
142-0005-0002	.160 [4.06] Dia. Knurl
142-0005-0003	.156 [3.96] Hex. w/ Safety Wire Holes

Assembly instructions: RF-ASMB-13, 142-0005-0001

¹Assembly tools; page 7101.

Featuring Twist Pin,
Pin and Socket Contacts
with Locking Interface

(Continued)

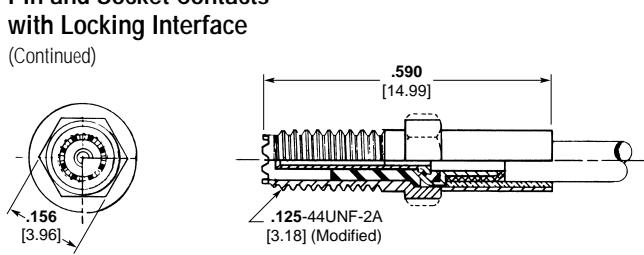

Straight Jack¹
Part Number 141-0017-0001
Instruction Sheet Number 408-08510
Former MICRODOT I.S. Number RF-ASMB-12

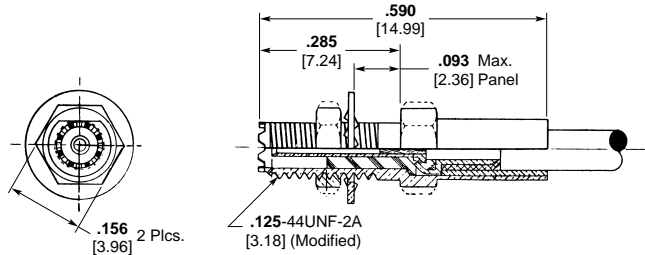

Bulkhead Jack¹
Part Number 141-0014-0001
Instruction Sheet Number 408-08510
Former MICRODOT I.S. Number RF-ASMB-12

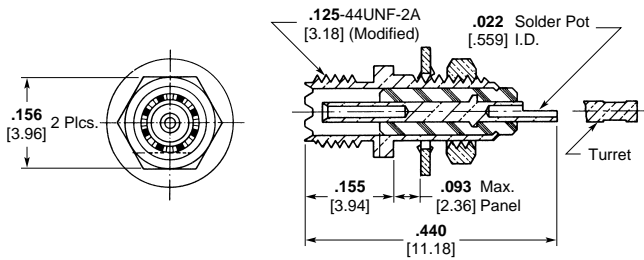

Front Mount Receptacle¹

Part No.	Contact Tail
141-0012-0001	Solder Pot
141-0012-0002	Turret

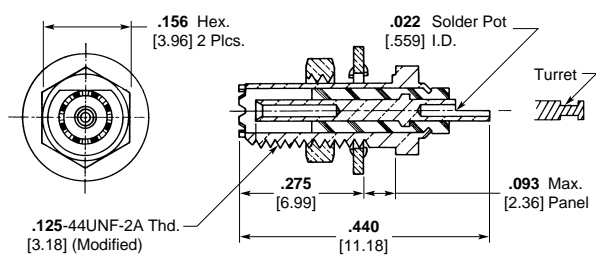

Rear Mount Receptacle w/ Locking Interface¹

Part No.	Contact Tail
141-0011-0001	Turret
141-0011-0002	Solder Pot

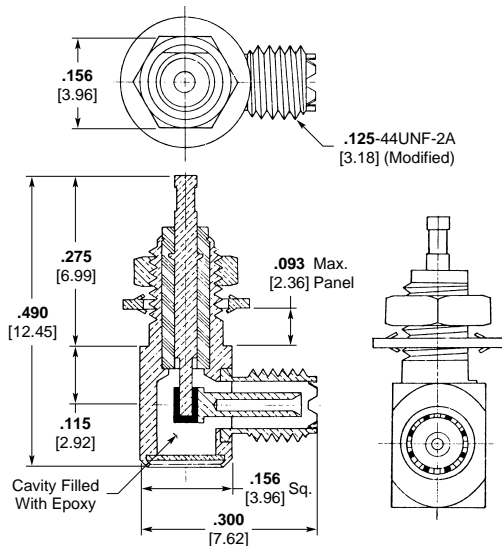

Right-Angle Receptacle¹
Part Number 141-0020-0001

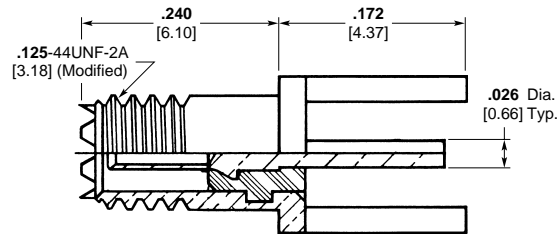

Straight Printed Circuit Receptacle¹
Part Number 141-0015-0001

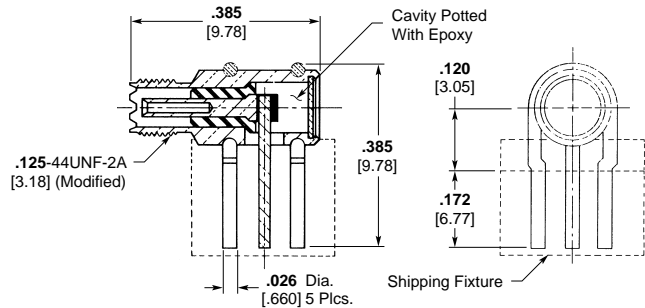

Right-Angle Printed Circuit Receptacle¹
Part Number 141-0023-0001

¹Mounting hole pattern and assembly tools shown on page 7101.

Featuring Twist Pin,
Pin and Socket Contacts

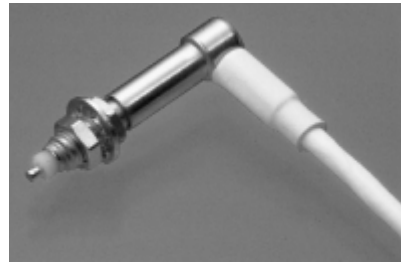

LEPRA/CON Slide-On Connectors offer a convenient mating style along with Ultra-miniature size. Inner contacts are twist pin tubular sockets in plugs and twist pin contacts for jacks and receptacles. Positive housing contact is provided by a three finger contact in the plug housing.

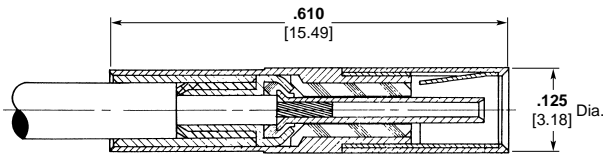

Straight Plug¹
Part Number 142-1000-0001
Instruction Sheet Number 408-08512
Former MICRODOT I.S. Number RF-ASMB-15

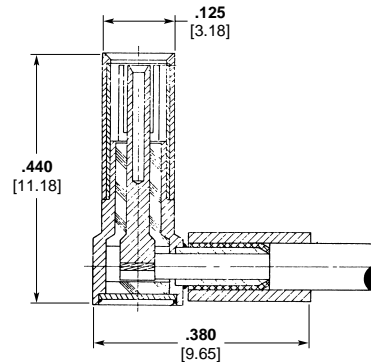

Right-Angle Plug¹
Part Number 142-1002-0001
Instruction Sheet Number 408-08513
Former MICRODOT I.S. Number RF-ASMB-16

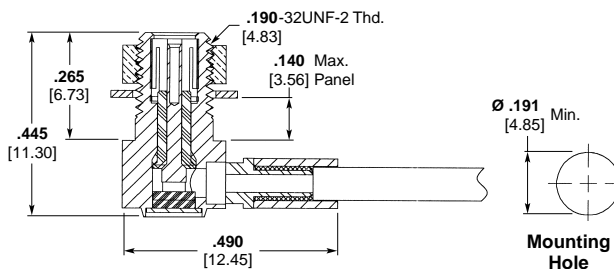
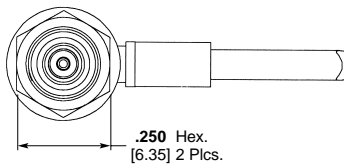

Right-Angle Bulkhead Mount Plug¹
Part Number 142-1021-0001
Instruction Sheet Number 408-08519
Former MICRODOT I.S. Number RF-ASMB-76

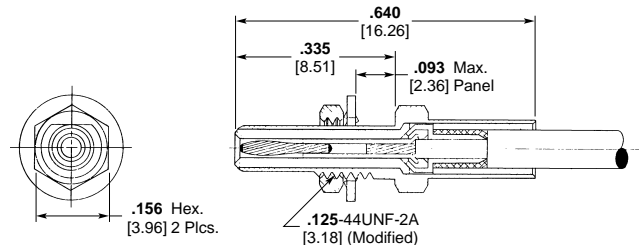

Straight Bulkhead Jack¹
Part Number 141-1001-0001
Instruction Sheet Number 408-08512
Former MICRODOT I.S. Number RF-ASMB-15

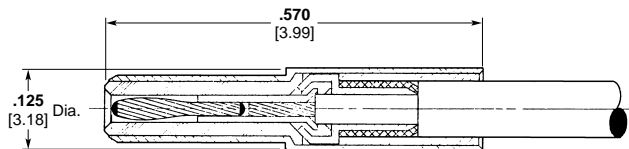

Straight Jack¹
Part Number 141-1000-0001
Instruction Sheet Number 408-08512
Former MICRODOT I.S. Number RF-ASMB-15

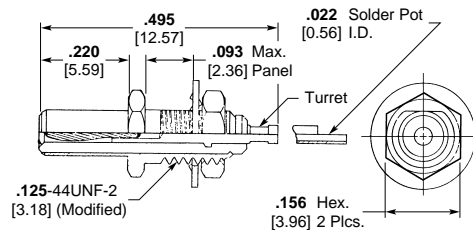

Front Mount Receptacle¹

Part No.	Contact Tail
141-1002-0001	Turret
141-1002-0002	Solder Pot

¹Mounting hole and assembly tools shown on page 7101.

Featuring Twist Pin, Pin and Socket Contacts

(Continued)

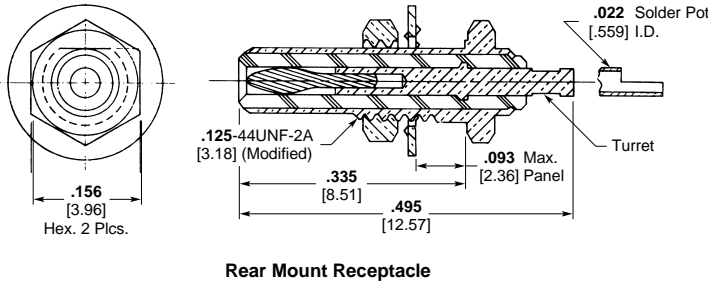

Rear Mount Receptacle

Part No.	Contact Tail
141-1003-0001	Turret
141-1003-0002	Solder Pot

Mounting Hole shown below.

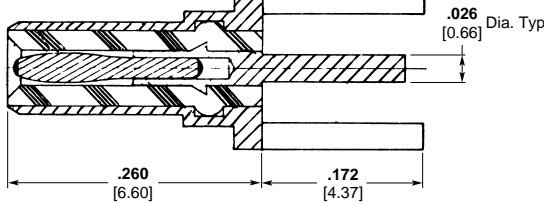

Straight Printed Circuit Receptacle Mounting Hole Pattern Shown Below Part Number 141-1004-0001

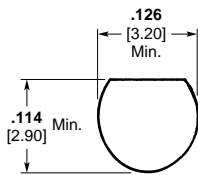

Bulkhead Receptacle Mounting Hole

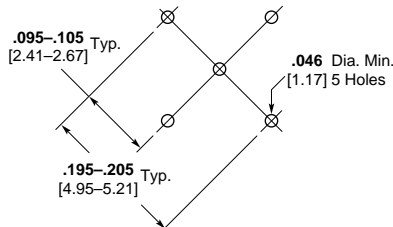

Standard Pattern

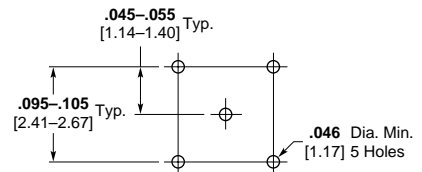

Small Pattern Connectors 141-0019-0001 and 141-0023-0001 Only

Printed Circuit Receptacle Mounting Hole Pattern

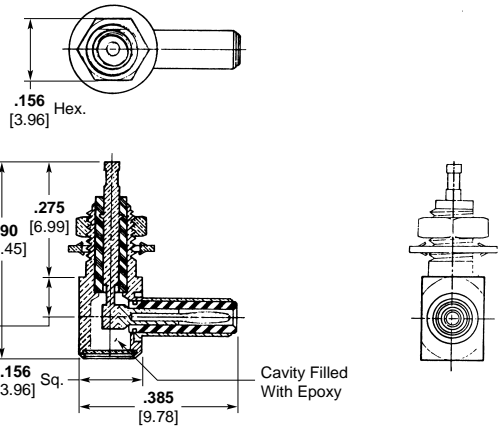

Right-Angle Receptacle Mounting Hole Shown Below Part Number 141-1012-0001

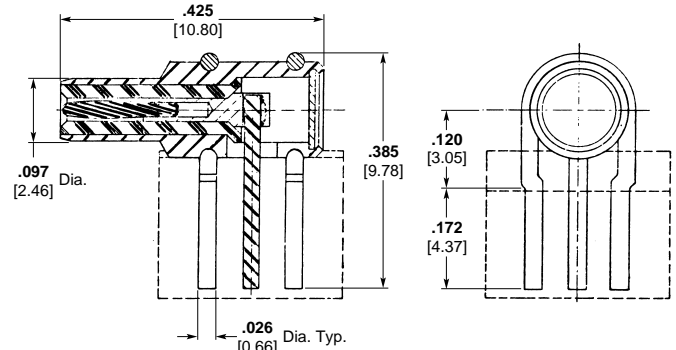

Right-Angle Printed Circuit Receptacle Mounting Hole Pattern Shown Below Part Number 141-1005-0001

LEPRA/CON Connector Assembly Tools

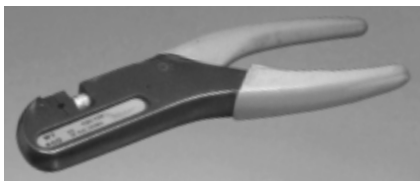

Housing Crimp Tool

MICRODOT Part No.	Thomas & Betts Part No.
010-0132-0000	WT-419

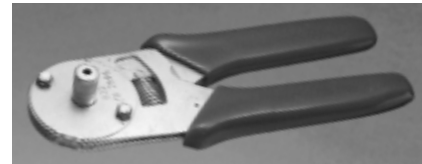

Contact Crimp Tool

Connector	Contact Crimp No.	Astro Tool Part No.
Straight Connector Only	010-0150-0000	A-826-1
141-1001-0001	010-0161-0000	827

BNC / LEPRA/CON Connector Adapters

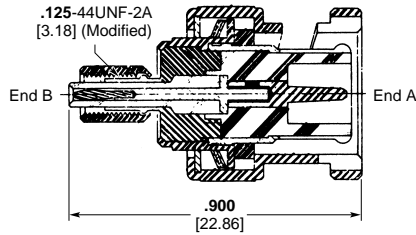

End "B" is MICRODOT Screw-On Plug End "A" is BNC Plug
Part Number 143-0001-0001

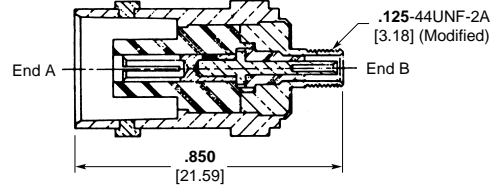

End "A" is BNC Receptacle End "B" is MICRODOT Screw-On Receptacle
Part Number 143-0003-0001

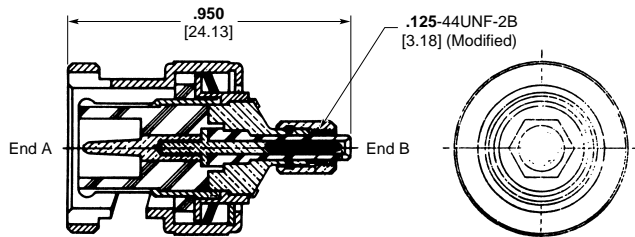

End "A" is BNC Plug End "B" is MICRODOT Screw-On Plug with Locking Interface
Part Number 143-0029-0001

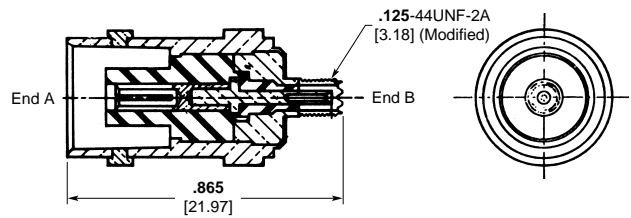

End "A" is BNC Receptacle End "B" is MICRODOT Screw-On Receptacle with Locking Interface
Part Number 143-0032-0001

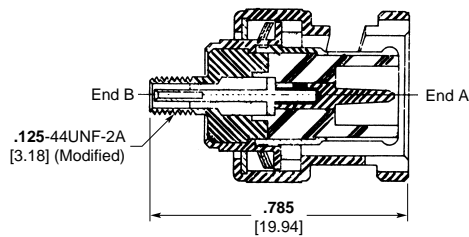

End "B" is Screw-On Receptacle End "A" is BNC Plug
Part Number 143-0002-0001

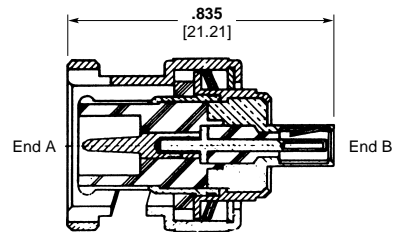

End "A" is BNC Plug End "B" is MICRODOT Slide-On Plug
Part Number 143-1000-0001

BNC / LEPRA/CON Connector Adapters

(Continued)

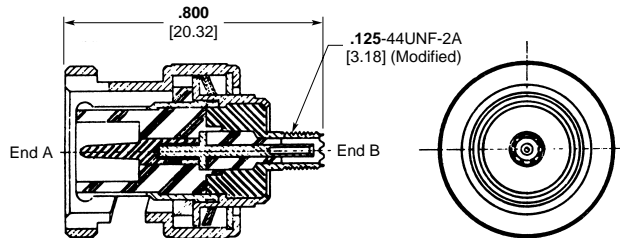

End "A" is BNC Plug End "B" is MICRODOT Receptacle with Locking Interface
Part Number 143-0031-0001

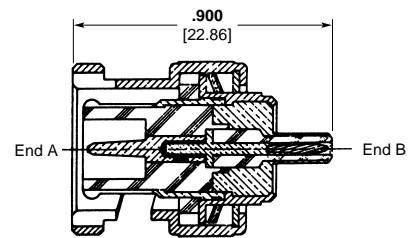

End "A" is BNC Plug End "B" is MICRODOT Slide-On Receptacle
Part Number 143-1002-0001

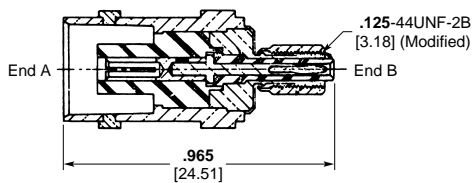

End "A" is BNC Receptacle End "B" is MICRODOT Screw-On Plug
Part Number 143-0004-0001

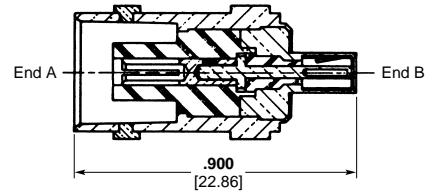

End "A" is BNC Receptacle End "B" is MICRODOT Slide-On Plug
Part Number 143-1001-0001

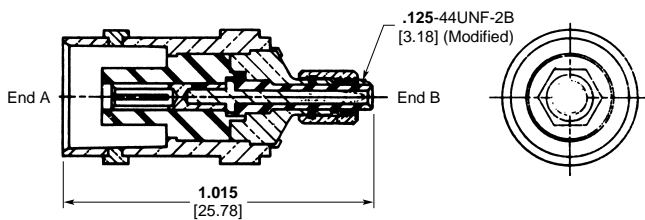

End "A" is BNC Receptacle End "B" is MICRODOT Screw-On Plug with Locking Interface
Part Number 143-0030-0001

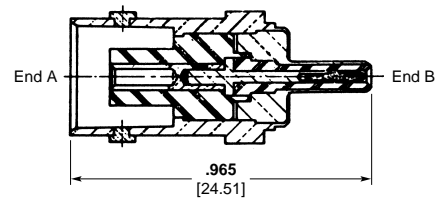

End "A" is BNC Receptacle End "B" is MICRODOT Slide-On Receptacle
Part Number 143-1003-0001

LEPRA/CON Ultra-Miniature Connectors — Snap-Lock Series

Product Facts

- Simple coupling design eliminates the need for tools and saves assembly time
- Positive locking mechanism provides its own fail-safe features
- Inspection of the mated connector is fast, simple and effective
- Push-Pull design allows higher panel density
- Quick-connect and disconnect features

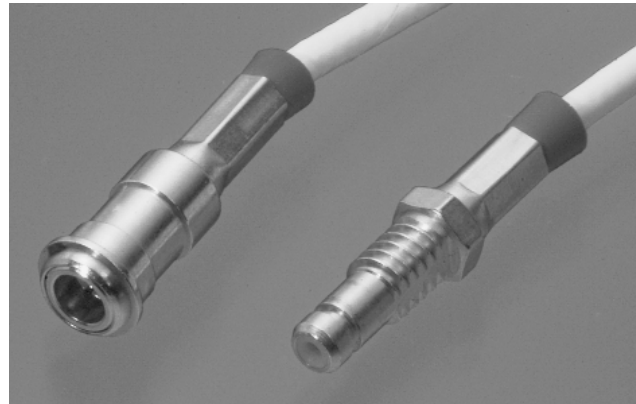

Performance Data Summary
For Snap-Lock Connectors

Electrical

Impedance — Designed to be compatible with 50 Ohm coaxial cables (Dual Shield RG 196).
Dielectric Withstanding Voltage — 450 volts RMS at sea level (Operating).
Contact Resistance — 8 milliohms max. at 3 amps. Average resistance: 4 milliohms
Insulation Resistance — 10⁴ megohms min.
Voltage Standing Wave Ratio (VSWR) — 3.4 max., 1.3 min. to 12 GHz.

Environmental

Temperature Range — -85°F to +257°F [-65°C to +125°C].
Vibration — MIL-STD-202, Method 204, Test condition D. No change in electrical discontinuity in excess of 1 microsecond.
Shock — MIL-STD-202, Method 213A, Test Condition C. No electrical discontinuity or evidence of physical damage.
Mechanical
Cable Acceptance Dimensions — Center conductor: .012 [0.31] nom. Dielectric: .040 [1.02] max. Shield: .080 [2.03] max. Jacket: .090 [2.29] max..

All-Crimp Assembly —

Center contacts and shield are crimped individually.
Durability — 500 mating cycles.
Materials
Body and Body Components — Brass per QQ-B-626 Comp 360.
Contact Material — Copper Alloy.
Crimp Sleeves — Leaded Copper.
Insulators — TEFLON per ASTM-D-1710.
Lockwashers — #425 Bronze Alloy.
Plating — Gold per MIL-G-45204, Type II, Grade C, Class 1.

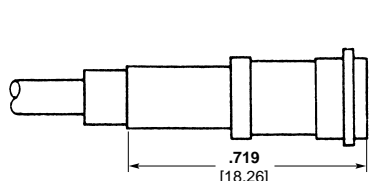

Straight Plug
Part Number 144-0001-0001

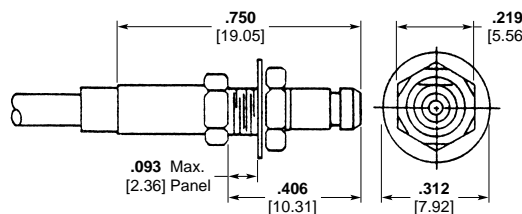

8-32 UNC-2A (Modified)
Bulkhead Jack, Rear Mount
Part Number 145-0001-0001

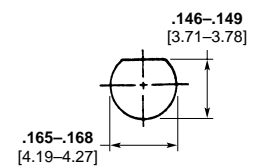

"D" Hole Dimensions
For Panel Mounting

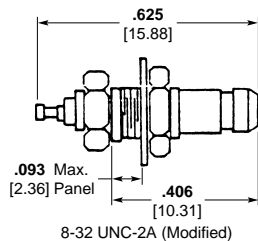

8-32 UNC-2A (Modified)
Receptacle, Rear Mount
Part Number 145-0003-0001

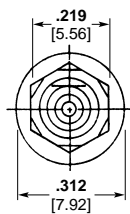
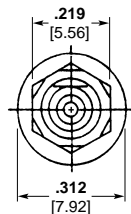

8-32 UNC-2A (Modified)
Receptacle, Front Mount
Part Number 145-0002-0001

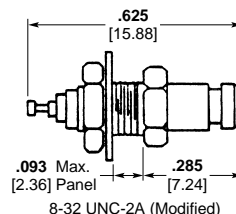

Connector/Cable Assembly
Crimp Tools — Center Contact
and Shield

Tool	Part No.
SKT & Pin Crimp	010-1004-0000
Housing Crimp	010-0081-0000

Cable Assemblies

Capability

The experience Tyco Electronics has gained through years of pioneering efforts in the development of MICRODOT miniaturized cable and connectors is available to customers in the assembly of complex cable/connector combinations. This experience offers the customer low cost and

no tooling charges, precision construction, thorough inspection and prompt delivery. The capability also makes it possible for the designer to specify a complete assembly or harness with the understanding that Tyco Electronics will deliver a custom fabrication equal in quality to the MICRODOT

components it contains. These assemblies are made to the customer's specifications or are designed by the Company's experienced engineers to fit particular requirements. Special features are light weight, reduced size, high operating temperatures and comprehensive layouts.

How To Order

1. Specify MICRODOT part numbers
 - A. Connector, one end
 - B. Connector, other end
 - C. Cable

2. Specify normal length
 - A. Overall length

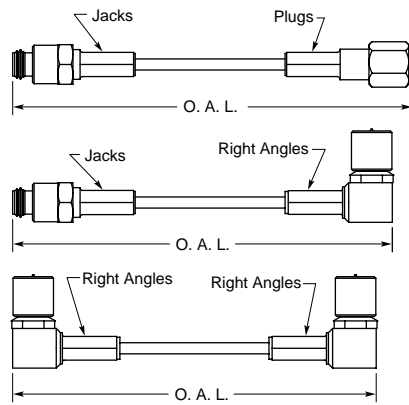

- B. Or length between connectors

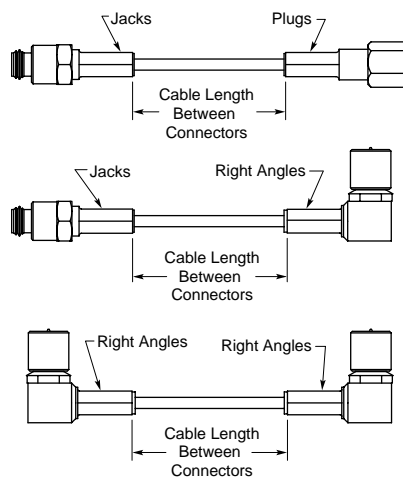

3. Specify length tolerance

- A. Standard tolerance

Assembly Length	Tolerance
0 thru 12-1/2"	±1/8"
Over 12-1/2" thru 1000"	±1% rounded to nearest 1/4"
Over 1000"	±1% rounded to nearest 1"

- B. Special tolerance

Tolerances as close as ±.5% are available for most cable assemblies at a premium rate. Consult Tyco Electronics for details.

4. Specify cable strip (Applies to cable assemblies with only one connector)

- A. Not stripped
 - B. Standard strip

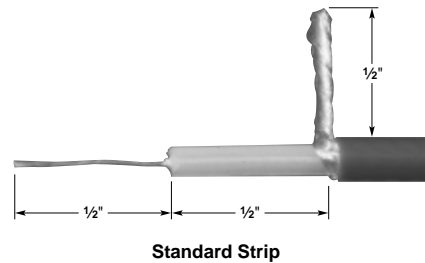

- C. Special strip - specify style

Example:

Connector:
142-1000-0001 one end
142-1002-0001 other end

Length:
36" overall, standard tolerance

Mating Interface Chart

Plugs			Jacks and Receptacles		
Series	Description	Page	Series	Description	Page
S50	Standard	7072, 7073	S50	Standard	7074, 7075
50 Ohm	Gold Plated Crimp Style	7091, 7092	50 Ohm	Gold Plated Crimp Style	7093, 7094
50 Ohm	Cap	7087	50 Ohm	Feed Thru Adapter	7088
S70	Standard	7072, 7073	S70	Standard	7074, 7075
70 Ohm	Gold Plated Crimp Style	7091, 7092	70 Ohm	Gold Plated Crimp Style	7093, 7094
70 Ohm	Cap	7087	70 Ohm	Feed Thru Adapter	7088
S93	Standard	7072, 7073	S93	Standard	7074, 7076
93 Ohm	Gold Plated Crimp Style	7092	93 Ohm	Gold Plated Crimp Style	7093, 7094
93 Ohm	Cap	7087	93 Ohm	Feed Thru Adapter	7088
SOS 50	Standard	7078, 7079	SOS 50	Standard	7079, 7080
SOS 70	Standard	7078, 7079	SOS 70	Standard	7079, 7080
SOS 93	Standard	7078, 7079	SOS 93	Standard	7079, 7080
QC 50	Standard	7082	QC 50	Standard	7083
QC 70	Standard	7082	QC 70	Standard	7083
QC 93	Standard	7082	QC 93	Standard	7083
Screw-On	Twinax	7084	Screw-On	Twinax	7084
Slide-On	Twinax	7084	Slide-On	Twinax	7084
Screw-On	Triax	7085	Screw-On	Triax	7085
Screw-On	LEPRA/CON Connector	7096	Screw-On	LEPRA/CON Connector	7096, 7097
Screw-On	LEPRA/CON Connector Interlocking Interface	7098	Screw-On	LEPRA/CON Connector Interlocking Interface	7099
Slide-On	LEPRA/CON Connector	7100	Slide-On	LEPRA/CON Connector	7101, 7102

Cable Acceptance Dimensions

Connector Part No.	Max. Jacket	Max. Shield	Max. Dielectric	Max. Inner Conductor
S-50				
032-0021-0001	.087 2.21	.061 1.55	.050 1.27	.013 .330
032-0023-0001	.087 2.21	.061 1.55	.041 1.04	.015 .381
032-0025-0001	.093 2.36	.068 1.73	.050 1.27	.013 .330
032-0033-0001	.093 2.36	.077 1.96	.047 1.00	.015 .381
032-0097-0001	.087 2.21	.061 1.55	.050 1.27	.015 .381
032-0098-0001	.087 2.21	.061 1.55	.041 1.04	.015 .381
032-0155-0001	.088 2.24	.061 1.55	.041 1.04	.015 .381
032-0156-0001	.088 2.24	.061 1.55	.041 1.04	.015 .381
052-0213-0001	.087 2.21	.061 1.55	.050 1.27	.013 .330
052-0235-0001	.087 2.21	.061 1.55	.041 1.04	.015 .381
052-0235-0003	.087 2.21	.061 1.55	.041 1.04	.015 .381
052-0370-0001	.093 2.36	.068 1.73	.041 1.04	.015 .381
052-0542-0001	.087 2.21	.061 1.55	.041 1.04	.015 .381
S-70				
032-0010-0001	.093 2.36	.075 1.91	.061 1.55	.013 .330
032-0022-0001	.093 2.36	.075 1.91	.059 1.50	.015 .381
032-0067-0001	.108 2.74	.079 2.01	.059 1.50	.015 .381
032-0078-0001	.108 2.74	.079 2.01	.061 1.55	.013 .330
032-0222-0001	.093 2.36	.075 1.91	.059 1.50	.015 .381
052-0092-0001	.093 2.36	.075 1.91	.059 1.50	.015 .381
S-93				
032-0011-0001	.134 3.40	.118 2.99	.100 2.54	.013 .330
032-0017-0001	.134 3.40	.118 2.99	.100 2.54	.015 .381
032-0066-0001	.154 3.91	.118 2.99	.101 2.67	.015 .381
032-0071-0001	.134 3.40	.118 2.99	.097 2.446	.031 .787
032-0092-0001	.155 3.94	.125 3.18	.107 2.72	.015 .381
032-0099-0001	.134 3.40	.118 2.99	.100 2.54	.015 .381
052-0200-0001	.134 3.40	.118 2.99	.100 2.54	.015 .381

Screw-On Series (Continued)
Right-Angle Plugs — Page 7073

Cable Acceptance Dimensions (Continued)

Connector Part No.	Max. Jacket	Max. Shield	Max. Dielectric	Nom. Inner Conductor
S-50				
032-0015-0001	.092 2.34	.060 1.52	Any	.012 .305
052-0204-0001	.092 2.34	.060 1.52	Any	.012 .305
052-0215-0001	.092 2.34	.060 1.52	Any	.012 .305
052-0337-0001	.111 2.81	.074 1.88	Any	.012 .305
S-70				
032-0013-0001	.111 2.81	.074 1.88	Any	.012 .305
052-0299-0001	.111 2.81	.074 1.88	Any	.012 .305
052-0379-0001	.111 2.81	.074 1.88	Any	.012 .305
S-93				
032-0014-0001	.134 3.40	.123 3.12	Any	.012 .305
032-0068-0001	.155 3.94	.118 2.99	Any	.012 .305
032-0153-0001	.155 3.94	.118 2.99	Any	.012 .305
052-0207-0001	.134 3.40	.123 3.12	Any	.012 .305
052-0298-0001	.134 3.40	.123 3.12	Any	.012 .305
052-0304-0022	.155 3.94	.118 2.99	Any	.012 .305

Jacks — Page 7074

Connector Part No.	Max. Jacket	Max. Shield	Max. Dielectric	Max. Inner Conductor
S-50				
031-0033-0001	.088 2.24	.061 1.55	.041 1.04	.021 .533
031-0034-0001	.087 2.21	.061 1.55	.041 1.04	.021 .533
051-0467-0001	.079 2.01	.061 1.55	.041 1.04	.021 .533
S-70				
031-0036-0001	.093 2.36	.075 1.91	.059 1.50	.021 .533
031-0048-0001	.093 2.36	.075 1.91	.059 1.50	.021 .533
031-0090-0001	.109 2.77	.079 2.01	.059 1.50	.021 .533
S-93				
031-0032-0001	.134 3.40	.118 2.99	.100 2.54	.021 .533
031-0037-0001	.134 3.40	.118 2.99	.100 2.54	.021 .533
031-0088-0001	.154 3.91	.118 2.99	.101 2.57	.021 .533
031-0089-0001	.154 3.91	.118 2.99	.101 2.57	.021 .533

Slide-On Series
Straight Plugs — Page 7078

Coaxial Connectors

Cable Acceptance Dimensions (Continued)

Connector Part No.	Max. Jacket	Max. Shield	Max. Dielectric	Max. Inner Conductor
SOS-50				
032-0055-0001	.088 2.24	.058 1.47	.041 1.04	.015 .381
032-0056-0001	.088 2.24	.058 1.47	.041 1.04	.015 .381
SOS-70				
032-0060-0001	.093 2.36	.075 1.71	.059 1.50	.015 .381
032-0061-0001	.093 2.36	.075 1.71	.059 1.50	.015 .381
032-0087-0001	.108 2.74	.079 2.01	.059 1.50	.015 .381
SOS-93				
032-0058-0001	.134 3.40	.118 2.99	.100 2.54	.015 .381
032-0077-0001	.134 3.40	.118 2.99	.100 2.54	.015 .381
032-0084-0001	.154 3.91	.118 2.99	.101 2.57	.015 .381

Right-Angle Plugs — Page 7079

Connector Part No.	Max. Jacket	Max. Shield	Max. Dielectric	Nom. Inner Conductor
SOS-50				
032-0063-0001	.092 2.34	.060 1.52	Any	.012 .305
SOS-70				
032-0062-0001	.111 2.82	.074 1.88	Any	.012 .305
SOS-93				
032-0059-0001	.134 3.40	.123 3.12	Any	.012 .305
032-0083-0001	.155 3.94	.118 2.99	Any	.012 .305

Jacks — Page 7079

Connector Part No.	Max. Jacket	Max. Shield	Max. Dielectric	Max. Inner Conductor
SOS-50				
031-0053-0001	.088 2.24	.061 1.55	.041 1.04	.021 .533
031-0054-0001	.088 2.24	.061 1.55	.041 1.04	.021 .533
SOS-70				
031-0095-0001	.108 2.74	.079 2.01	.059 1.50	.021 .533
SOS-93				
031-0063-0001	.134 3.40	.118 2.99	.100 2.54	.021 .533
031-0064-0001	.134 3.40	.118 2.99	.100 2.54	.021 .533
031-0093-0001	.154 3.91	.118 2.99	.101 2.57	.021 .533
031-0094-0001	.154 3.91	.118 2.99	.101 2.57	.021 .533

Quick-Connect Series
Straight Plugs — Page 7082

Coaxial Connectors

Cable Acceptance Dimensions (Continued)

Connector Part No.	Max. Jacket	Max. Shield	Max. Dielectric	Max. Inner Conductor
QC-50				
032-0002-0001	.093 2.36	.058 1.47	Any	.013 .330
032-0030-0001	.093 2.36	.058 1.47	.041 1.04	.015 .381
QC-70				
032-0016-0001	.093 2.36	.075 1.91	.061 1.55	.013 .330
032-0031-0001	.093 2.36	.075 1.71	.059 1.50	.015 .381
032-0079-0001	.108 2.74	.079 2.01	.059 1.50	.015 .381
QC-93				
032-0012-0001	.134 3.40	.118 2.99	.100 2.54	.013 .330
032-0032-0001	.134 3.40	.118 2.99	.100 2.54	.015 .381
032-0072-0001	.154 3.91	.118 2.99	.101 2.57	.015 .381

Right-Angle Plugs — Page 7082

Connector Part No.	Max. Jacket	Max. Shield	Max. Dielectric	Nom. Inner Conductor
QC-50				
032-0026-0001	.092 2.34	.060 1.52	Any	.012 .305
QC-70				
032-0027-0001	.111 2.82	.074 1.88	Any	.012 .305
QC-93				
032-0020-0001	.134 5.40	.123 3.12	Any	.012 .305
052-0228-0001	.155 3.94	.118 2.99	Any	.012 .305

Jacks — Page 7083

Connector Part No.	Max. Jacket	Max. Shield	Max. Dielectric	Max. Inner Conductor
QC-50				
031-0038-0001	.093 2.36	.061 1.55	.041 1.04	.021 .533
QC-93				
031-0040-0001	.134 3.40	.118 2.99	.100 2.54	.021 .533

Twinax Plugs — Page 7084

Connector Part No.	Max. Jacket	Max. Shield	Max. Dielectric	Max. Inner Conductor
032-0088-0001	.167 4.24	.142 3.60	.061 1.55	.014 .356
032-0093-0001	.123 3.12	.092 2.34	.042 1.07	.014 .356
052-0229-0001	.123 3.12	.092 2.34	.042 1.07	.014 .356
052-0324-0001	.167 4.24	.142 3.61	.061 1.55	.014 .356

Jacks — Page 7084

Connector Part No.	Max. Jacket	Max. Shield	Max. Dielectric	Max. Inner Conductor
051-0358-0001	.167 4.24	.142 3.60	.061 1.55	.020 .508
051-0389-0001	.167 4.24	.142 3.61	.061 1.55	.020 .508

Triax

Plugs — Page 7085

Gold Plated Crimp Style Coaxial Connectors

Straight Plugs — Pages 7091, 7092

Right-Angle Plugs — Page 7092

Coaxial Connectors

Cable Acceptance Dimensions (Continued)

Connector Part No.	Max. Jacket	Max. Outer Shield	Max. Outer Dielectric	Max. Inner Shield	Max. Inner Dielectric	Max. Inner Conductor
052-0130-0001	.124 3.15	Single Shield	.085 2.26	Single Shield	.041 1.04	.014 .356
052-0138-0001	.183 4.65	Single Shield	.146 3.71	.118 2.99	.107 2.72	.014 .356
052-0593-0001	.214 5.44	Single Shield	.166 4.22	.161 4.09	.131 3.33	.020 .508

Connector Part No.	Max. Jacket	Max. Dielectric	Nom. Inner Conductor
50 Ohm Series			
132-0112-000*	.088 2.24	.039 .991	.012 .305
132-0113-000*	.088 2.24	.039 .991	.012 .305
132-0114-000*	.110 2.79	.070 1.78	.012 .305
132-0115-000*	.110 2.79	.070 1.78	.012 .305
132-0509-0002	.116 2.95	.070 1.78	.012 .305
70 Ohm Series			
132-0200-000*	.110 2.79	.070 1.78	.012 .305
132-0201-000*	.110 2.79	.070 1.78	.012 .305
93 Ohm Series			
132-0300-000*	.155 3.94	.107 2.72	.012 .305
132-0301-000*	.155 3.94	.107 2.72	.012 .305

Connector Part No.	Max. Jacket	Max. Dielectric	Nom. Inner Conductor
50 Ohm Series			
132-0116-0002	.088 2.24	.039 .991	.012 .305
132-0117-0002	.088 2.24	.039 .991	.012 .305
132-0118-0002	.110 2.79	.074 1.88	.012 .305
132-0119-0002	.110 2.79	.074 1.88	.012 .305
70 Ohm Series			
132-0202-0002	.110 2.79	.074 1.88	.012 .305
132-0203-0002	.110 2.79	.074 1.88	.012 .305
93 Ohm Series			
132-0302-0002	.155 3.94	.107 2.72	.012 .305
132-0303-0002	.155 3.94	.107 2.72	.012 .305

Gold Plated Crimp Style
Coaxial Connectors (Continued)

Jacks — Page 7093

Cable Acceptance Dimensions (Continued)

Connector Part No.	Max. Jacket	Max. Dielectric	Nom. Inner Conductor
50 Ohm Series			
131-0134-0001	.088 2.24	.039 .991	.012 .305
131-0135-0001	.088 2.24	.039 .991	.012 .305
131-0136-0001	.110 2.79	.070 1.78	.012 .305
131-0137-0001	.110 2.79	.070 1.78	.012 .305
70 Ohm Series			
131-0200-0001	.110 2.79	.070 1.78	.012 .305
131-0201-0001	.110 2.79	.070 1.78	.012 .305
93 Ohm Series			
131-0300-0001	.155 3.94	.107 2.72	.012 .305
131-0301-0001	.155 3.94	.107 2.72	.012 .305

LEPRA/CON Connectors

All — Pages 7095-7104

Connector Part No.	Max. Jacket	Max. Dielectric	Nom. Inner Conductor
All	.081 2.06	.040 1.02	.012 .305

Coaxial Screw-On, Slide-On Series

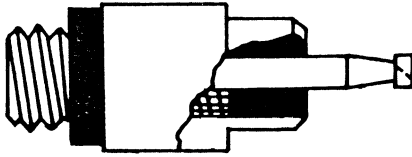

Material and Finish

50 Connector uses 10-32 thread.
 70 Connector uses 12-32 thread.
 93 Connector uses 1/4-32 thread.
Housing (1) — Cold rolled steel silver plate.
Gasket (2) — Neoprene or silicone rubber.
Insulator (3) — TEFLON.
Glass Seal (4)
Center Contact (5) — Nickel Iron alloy contact with slotted turret type solder pot (other terminations available).

Service and Performance Data

Temperature Range — -65°F to 450°F [-54°C to 232°C].
Electrical — 750 VAC working voltage.
Performance — 1200 VAC test at sea level.
Insulation Resistance — 5000 megohms at 500 VDC (room temperature).
Shock — 100 G's minimum.
Pressure — 100 PSI minimum.
Leak Rate Per Seal — Less than 1.04 x 10⁻⁸ cc/sec. (.001 Micron cubic ft/hr) of 100% helium tested at one atmosphere pressure differential far exceeding requirements of MIL-C-26500 and MIL-C-26482.
Plating — Silver unless otherwise specified.

Bulkhead Solder Mount

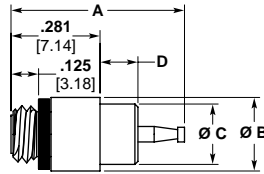

Fig. 1

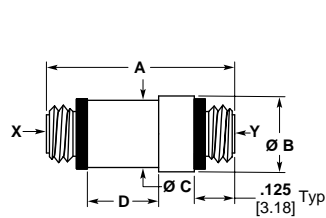

Fig. 2

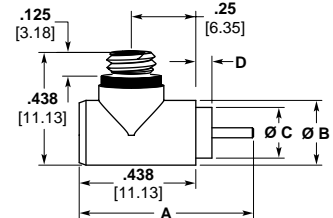

Fig. 3

Part No.	Fig.	A	B Dia.	C Dia. ±.015	D	X*	Y*
051-0049-0001	1	.563 14.30	.25 6.35	.200 5.08	.125 3.18	S-50	—
051-0056-0001	1	.563 14.30	.313 7.95	.251 6.38	.125 3.18	S-93	—
053-0228-0001	2	.594 15.09	.25 6.35	.227 5.77	.234 5.94	S-50	S-50
051-0315-0001	3	.656 16.66	.25 6.35	.195 4.95	.063 1.60	S-50	—

* "S" indicates Screw-On Series
 Dimensions are subject to change without notice.

Bulkhead Solder Mount, Panel Insulated

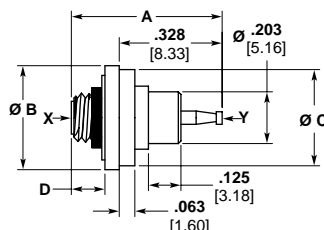

Fig. 1

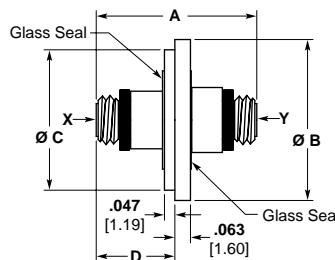

Fig. 2

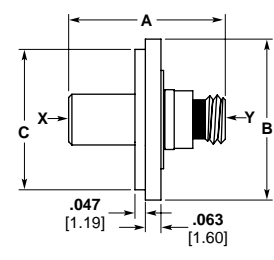

Fig. 3

Part No.	Fig.	A	B Dia.	C Dia.	D	X*	Y*
051-0232-0001	1	.563 14.30	.406 10.31	.370 9.40	.172 4.37	—	S-50
053-0227-0001	2	.609 15.47	.625 15.88	.540 13.72	.297 7.54	S-50	S-50
053-0412-0001	2	.609 15.47	.625 15.88	.540 13.72	.297 7.54	S-93	S-93
053-0028-0001	3	.609 15.47	.625 15.88	.540 13.72	.297 7.54	SOS-50	S-50

* "S" indicates Screw-On Series; "SOS" indicates Slide-On Series
 Dimensions are subject to change without notice.

Coaxial Screw-On, Slide-On Series

(Continued)

Microminiature Coaxial Receptacles

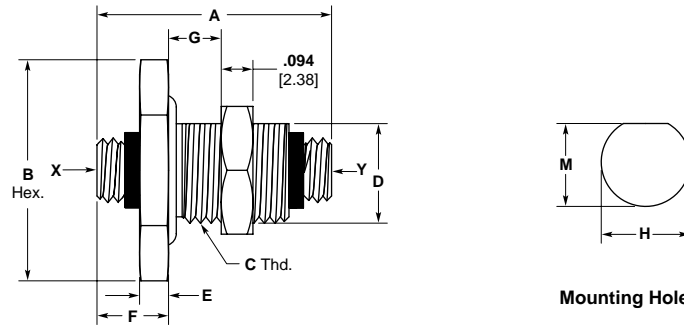

Part No.	A	B Hex.	C Thd.	D	E	F	G	H	M	X*	Y*
053-0455-0001	.688 17.46	.563 14.29	5/16-32 UNEF-2A	.297 7.54	.094 2.38	.203 5.16	.25 6.35	.312 7.92	.291 7.39	S-50	S-50
053-0636-0001	.922 23.42	.625 15.88	3/8-32 UNEF-2A	.344 8.73	.078 1.98	.203 5.16	.438 11.11	.375 9.53	.347 8.81	S-93	S-93

* "S" indicates Screw-On Series
Dimensions are subject to change without notice.

Solder Mount Slide-On Series Receptacles

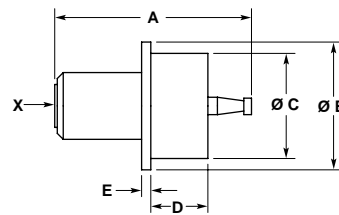

Part No.	A	B Dia.	C Dia. ±.015	D	E	X*
051-0134-0001	.563 14.29	.375 9.53	.309 7.85	.172 4.37	.031 .794	SOS-50, 70, 93
051-0158-0001	.563 14.29	.25 6.35	.200 5.08	.125 3.18	.047 1.19	SOS-50, 70, 93

* "SOS" indicates Slide-On Series
Dimensions are subject to change without notice.

Single Hole Mount Receptacles

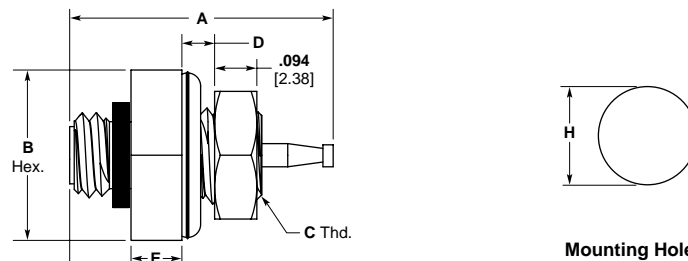

Part No.	A	B Hex.	C Thd.	D	E	F	H	X*
051-0249-0001	.563 14.29	.375 9.53	12-32 UNEF-2A	.078 1.98	.109 2.78	.234 5.95	.218 5.54	S-50
051-0154-0001	.656 16.67	.625 15.88	3/8-32 UNEF-2A	.156 3.97	.078 1.98	.203 5.16	.375 9.53	S-93

* "S" indicates Screw-On Series
Dimensions are subject to change without notice.

Theory and Application

As a leading manufacturer of RF products, Tyco Electronics produces a large variety of coaxial connectors. The proper selection and application of these connectors requires a knowledge of factors not involved in other types of connectors and terminals. The following paragraphs have been prepared to improve understanding of the theory behind RF connectors:

Basic RF Theory¹

RF energy travels by electromagnetic waves, and it is primarily the frequency of these waves that we are interested in. Briefly, if an oscillating voltage source is connected to a cable, a continuous electromagnetic wave will propagate along the cable. A sensor placed at some point on the cable would indicate a varying voltage (E field) as well as a current and magnetic field (H field) as the wave travels past it. This is called an electromagnetic wave because both electric and magnetic fields are varying. The wave shape is initially determined by the variation of the source with time.

Figure 7 shows the radiant energy spectrum. Visible light, radio, television, x-rays and Gamma rays are all phenomenon of electromagnetic waves at different frequencies. This introduction will treat only those that are generated by an electrical source and propagated along a physical cable or other transmission media. That is, frequencies above zero and up to about 50 gigahertz.

¹The majority of the technical terms, relative to RF and coaxial cable and connectors, used here-in and throughout this catalog are defined in the Glossary of Terms in Section 18.

Frequency or Wavelengths	Designation	Applications
0 - 29.9 KHz	VLF (Very Low Frequency)	Commercial AC electricity, deep depth sounders, ultrasonic grinders, sonic oscillators
30 - 299.9 KHz	LF (Low sonar Frequency)	Shallow-to-medium depth sounders
300 - 2999.9 KHz	MF (Medium Frequency)	Commercial AM radio broadcasting, marine radio telephone, direction finders
3 - 29.9 MHz	HF (High Frequency)	Citizen band radio, amateur radio, international broadcasting
30 - 299.9 MHz	VHF (Very High Frequency)	VHF television (Channels 2 thru 13), commercial FM radio broadcasting, amateur radio, fire and police radio
300 - 2999.9 MHz	UHF (Ultra-high Frequency)	UHF television (Channels 14 thru 83), microwave ovens, aeronautical radionavigation
3 - 29.9 GHz	SHF (Super High Frequency)	Microwave communications, marine radar, aircraft tracking and airborne radars
30 - 299.9 GHz	EHF (Extremely High Frequency)	Space communications, radio astronomy

Notes:

- 1. KHz = Kilohertz (1 thousand cycles per second)
- 2. MHz = Megahertz (1 million cycles per second)
- 3. GHz = Gigahertz (1 billion cycles per second)

Figure 7

Radiant Energy Spectrum

In the following paragraphs we will discuss waves in greater detail, including the relationship of frequency and wave length, how pulses are formed and used, how each differs from the other and the problems involved in their transmission.

Sine Waves

An RF wave is a sine wave, meaning that it smoothly swings from zero to a positive peak value, then back down past zero to a negative peak value, then back to zero to complete a 360 electrical degree cycle. The positive and negative peaks are always equal in amplitude. The two qualities which characterize this type of wave are amplitude and frequency (f). Figure 8 shows these two characteristics. Amplitude refers to the peak value attained by the wave and corresponds to voltage. Frequency refers to the number of oscillations per second. For example, the sign wave in Figure 8(B) has completed 12 cycles in one second. Therefore, we would say that this wave has a frequency of 12 cycles per second or 12 Hertz. The time for one complete cycle is defined as the period (T). The relationship between the period and frequency is given by the equation:

$$f = 1 / T \text{ in Hertz}$$

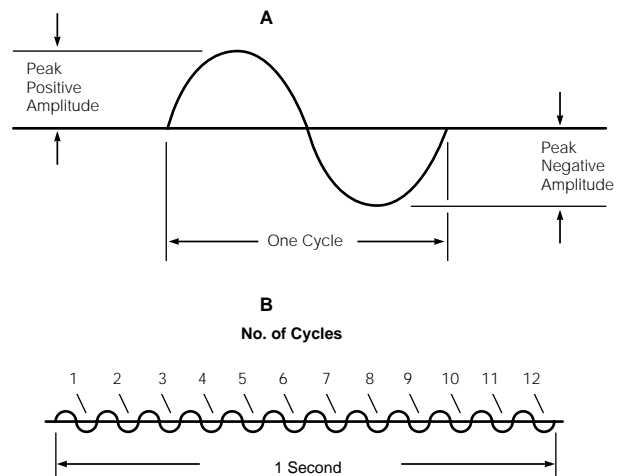

Figure 8

Typical Sine Wave Characteristics

The wave travels away from the generator at speeds approaching the speed of light. When an electromagnetic wave travels in a medium other than air or vacuum, the **speed** for the wave is reduced by a factor of the square root of the dielectric constant (ϵ). The velocity (v) of the propagation of a signal is given by:

$$v = \frac{c}{\sqrt{\epsilon}}$$

Where c is the speed of light, 3×10^8 m/sec or 1.18×10^{10} in/sec, and ϵ is the dielectric constant of the medium. (See Table 1 for dielectric constants of various materials)

The **wavelength** of a signal is given by the formula

$$\lambda = v/f = \frac{c}{\sqrt{\epsilon} \times f \text{ (GHz)}} = \frac{1.18 \times 10^{10}}{\sqrt{\epsilon} \times f \text{ (GHz)}} \text{ inches}$$

See Figure 9

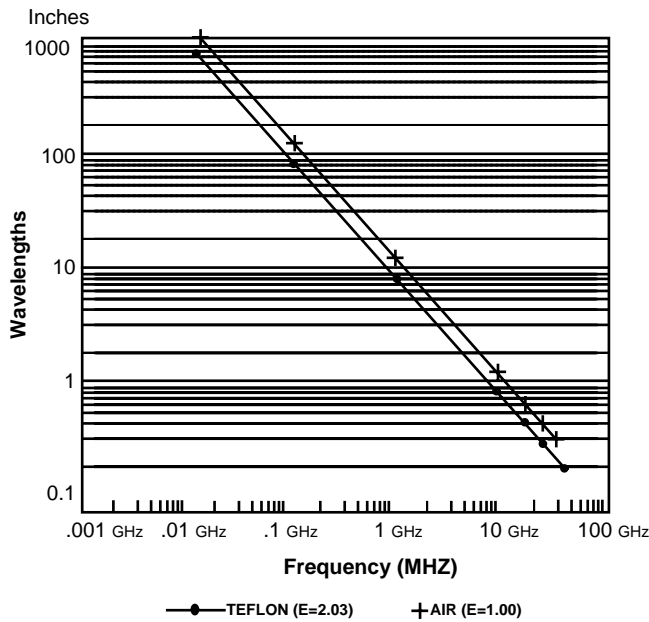

Figure 9

Table 1. Properties of Insulating Materials

Dielectric Material	Dielectric Constant	Operating Temperature Range
TFE	2.03	-70 +250°C
Polyethylene	2.3	-60 +80°C
Nylon	4.6-4.0	-40 +120°C
TPX	2.12	-65 +85°C
Polypropylene	2.25	-40 +105°C
Acetal	3.7	-65 +85°C

Pulses

The sine wave is most often used for communication purposes where intelligence is imposed on the wave by a variation in amplitude (amplitude modulation, AM) or by a variation in frequency (frequency modulation, FM).

Pulses, on the other hand, are primarily used in computers and digital instrumentation. Since pulses are generally used for triggering purposes, the pulse rise/fall time, amplitude and width are the most important. Figure 10 shows a pulse and identifies these characteristics.

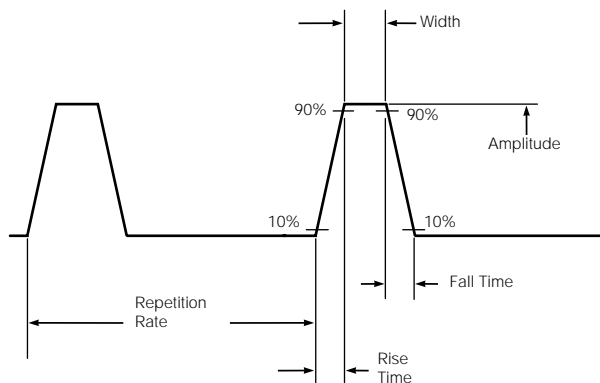

Figure 10

Pulse Characteristics

Notice that rise time is the time required for the pulse to rise from 10% to 90% of its amplitude — not from zero to maximum. Rise and fall time is perhaps the single most important characteristic of a pulse in today's high-speed digital equipment. Figure 11 shows that the faster the rise and fall time, the more pulses will fit in a given time frame.

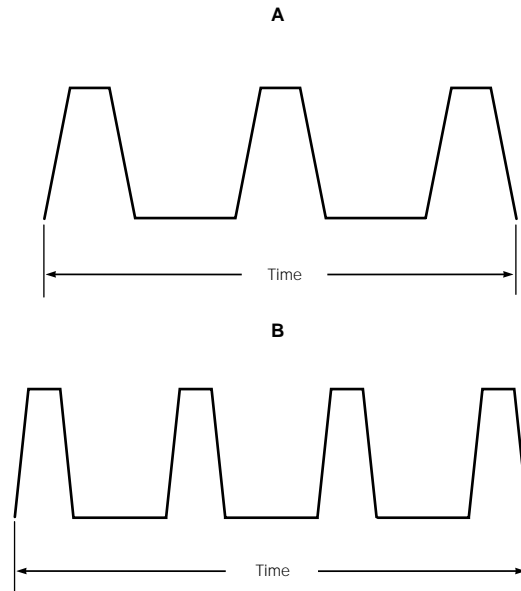

Figure 11

Pulse Rise and Fall Time

The bit rate for a system is the maximum rate of pulses per second that a system can process without causing data errors. The maximum performance can also be specified in terms of baud rate. The baud rate is defined as the number of characters (bytes) that are transmitted per second.

Generally a character represents 10 bits (7 bits for the information, one parity bit, and two for start and stop, totalling 10).

Now that we know why fast pulses are required, the next problem is how to obtain faster rise times. A pulse is made up of a great number of different frequencies, and the more high frequencies a pulse contains, the faster will be its rise time and the flatter will be its peak. To better understand this, refer to Figure 12. At A, you will see a fundamental frequency (1), its third harmonic (3), and the resultant waveform (S3), which is a combination of 1 and 3. Although this does not yet resemble a square wave, you will note that the rise time is decreased, and a dip appears at the peak. At B of Figure 12, we have added the fifth harmonic. Rise time is further decreased, and the peak is beginning to flatten out. At C the seventh harmonic has been included, and the resultant wave S7 begins to resemble a square wave. As more high frequency harmonics are added to the waveform, it will more closely resemble a square wave, and the squarer it becomes, the faster will be the rise time.

Fast rise times and short pulse widths require high frequency components.

Two frequent causes of digital signal degradation can be (1) high capacitance of the transmission line and (2) impedance mismatches of connector transmission line or I/O devices. Selection of an impedance-matched connector on a digital line, especially if short cable assemblies are used, can be as important as connector selection for an RF modulated line. **Reflected pulses out of phase with the original pulse can cause false signals or high error rates in a digital system.**

Since pulses with fast rise times are necessary in high-speed computers, any circuit element which could reduce or attenuate high frequency response is undesirable.

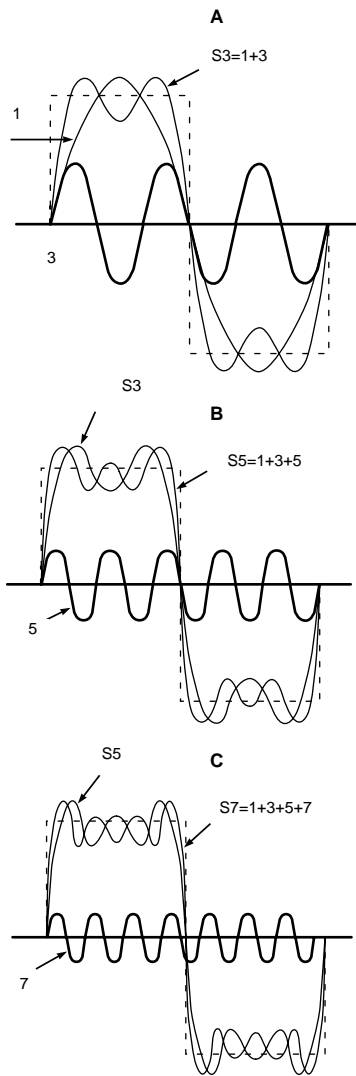

Figure 12

Development of a Square Wave

Signal Integrity and Propagation

To explain how to maintain signal integrity, it is necessary to review how the signal is configured in a cable and how it propagates. Ignoring digital signals for this discussion we will identify the issues that deal with the integrity of a sine wave. Consider a coaxial cable consisting of an inner conductor surrounded by a dielectric material and then an outer conductor (See Figure 13). The outer conductor may be a braid, a foil, or a solid metal.

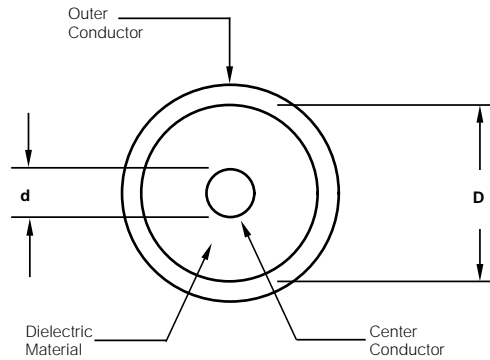

Figure 13

Diagram of a Cable

An electromagnetic wave traveling in a coaxial cable produces an electric and a magnetic field between the inner conductor and the outer conductor (Figure 14). The electric (E field) is radial and varies in time. An alternating current flows along the inner conductor and the outer conductor. An oscillating magnetic field (H field) circles the inner conductor.

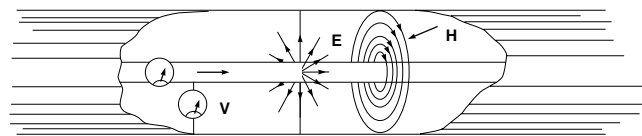

Figure 14

Electric field (E) and magnetic field (H) belonging to the principal mode in a coaxial line.

The alternating current on a conductor is not spread throughout the conductor but is strongest at the surface and decays exponentially at points further into the conductor. This is called the skin effect. At a frequency of 1MHz, three skin depths is 0.0078" (95% of the current is within three skin depths of the surface) and at 10GHz three skin depths is 0.00078". As a result, the current is on the outer surface of the inner conductor and the inner surface of the outer conductor over the entire range of interest for most RF systems. The dimensions and material beyond several skin depths have no effect on the wave; gold plated plastic will propagate as well as gold plated copper at sufficiently high frequencies.

Attenuation

A wave loses energy (attenuates) in several ways: (1) The resistance of the inner and outer conductors is small but can be significant over long lengths and will produce some heat. (2) The dielectric may be lossy; its resistance is high but not infinite, and some energy is lost. (3) Electromagnetic energy radiates at high frequencies; significant energy losses are caused by radiation of electromagnetic energy (the cable acts like an antenna). (4) Energy is reflected due to impedance mismatches. The combination of these four types of losses are referred to as the **insertion loss** of a transmission line system. Connectors have similar losses.

Characteristic Impedance

A parameter which defines the behavior of a cable, connector, or any propagating system is **Characteristic Impedance, Z_0** . The characteristic impedance of a lossless cable is related to the inductance per unit length, L , and the capacitance per unit length, C , as follows:

$$Z_0 = \sqrt{L/C} \text{ in ohms}$$

The equivalent circuit of a transmission line is shown in Figure 15. R represents the conductor resistance for a unit length

For a coaxial cable the characteristic impedance is given by:

$$Z_0 = \frac{138}{\sqrt{\epsilon}} \times \text{Log}_{10} \frac{D}{d} \text{ in ohms}$$

where D is the inner diameter of the outer conductor and d is the outer diameter of the inner conductor, respectively. Similar equations apply for other geometries such as two parallel wires.

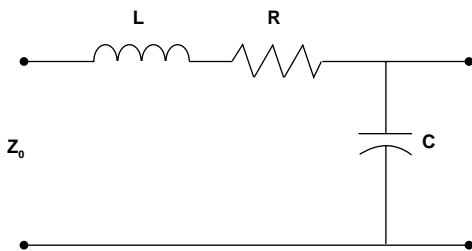

Figure 15

Typical Transmission Line Schematic

The maximum power is transferred between two systems if they have the same impedance. This is called impedance matching. However, impedance variations that are short compared to a wavelength can have a negligible effect on signal loss.

Standard impedances are 50 ohm, 75 ohm and 93-125 ohm. Most systems use 50 ohm because it is a compromise between maximum power transmission and minimum line loss. The telephone industry and the broadcast industry use 75 ohm for minimum line attenuation. The need for low capacitance instrumentation cable has produced the 93-125 ohm systems. The higher impedances are generally achieved by changing the conductor diameters and by modifying the dielectric material to add air.

Reflections

When the characteristic impedance changes in a transmission line system, part of an incident wave is reflected. The reflection coefficient can be calculated as:

$$\text{Reflection Coefficient} = \rho = \frac{V_i}{V_R} = \frac{Z_R - Z_0}{Z_R + Z_0}$$

Where V_i and Z_0 are the incident voltage and impedance of the first media. V_R and Z_R represent the reflected voltage and impedance of the media that caused the reflection. The decibel loss due to reflection is given by:

$$\text{Return Loss} = 10 \text{ Log}_{10} \left(\frac{1}{1 - \rho^2} \right) \text{ dB}$$

VSWR

The traditional way to determine the reflection coefficient is to measure the standing wave caused by the superposition of the incident wave and the reflected wave. Traditionally the voltage is measured at a series of points using a slotted line. The ratio of the maximum divided by the minimum is the Voltage Standing Wave Ratio (VSWR). The VSWR is infinite for total reflections because the minimum voltage is zero. If no reflection occurs the VSWR is 1.0. VSWR and reflection coefficient are related as follows:

$$\text{VSWR} = (1 + \rho)/(1 - \rho)$$

Most present instrumentation measures the reflection coefficient and calculates the VSWR.

Figure 16 represents the direct relationship between VSWR and its equivalent in return loss (expressed in dB).

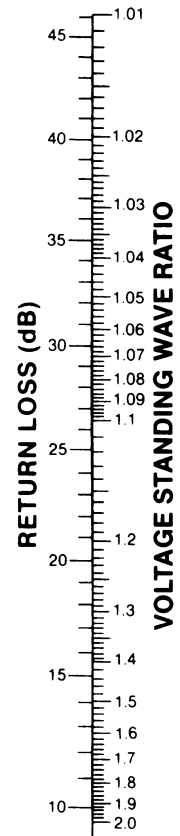

Figure 16

VSWR vs. Return Loss

Multiple Reflections

If there is a series of impedance changes, each one will have a reflection coefficient. The total reflection coefficient is the vector addition of each of the individual coefficients accounting for the distance between reflections and the reflection of any reflected waves. Even though the calculations are difficult, a total VSWR can still be measured.

Multiple reflections can produce a resonance phenomenon that is unique to wave theory. Properly understood some serious difficulties can be avoided. An example will make the point clear. Consider an electromagnetic wave with a wave-

length of 4 inches traveling on a cable that changes from 50 ohms to 25 ohms. The reflection coefficient is $-.33$, which means that one third of the incident voltage is reflected toward the source. Assume that one inch (one quarter wavelength) down the cable the impedance changes back to 50 ohm. Again, one third of the wave is reflected, but without any phase shift. It travels back to the first interface where one third of this reflected wave is reflected back toward the second interface. Two thirds of the wave is transmitted through the interface and travels back to the source. Since the first (reflected) wave is shifted 180 degrees at the reflection, and the second (transmitted-reflected-transmitted) wave is shifted 180 degrees because it traveled the one inch separation twice, the two waves are in phase. The net result is that the VSWR is much larger because the length of the 25 ohm section was just the right length to cause a resonance. If the length of the 25 ohm section had been one half wavelength, the two waves would have interfered and the VSWR would be at a minimum.

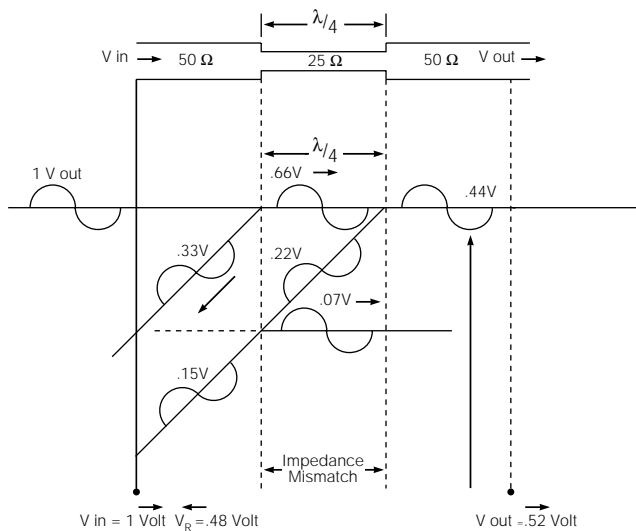

Figure 17
Multiple Wave Reflections
 (Caused by Impedance Mismatch)

In summary, avoid cable lengths, printed circuit board paths, or connectors that are multiple of one quarter ($\lambda/4$, $3\lambda/4$, etc.) of the intended signal transmission wavelength. Coaxial cables, when manufactured, also have periodic variations in diameter that result in periodic changes in impedance (Z_0), that can cause significant levels of reflected signal (high return loss) at specific frequencies.

Reflections of Digital Signals

The previous discussions dealing with attenuation, reflections and standing waves can apply to digital signals with some extra thought.

A single pulse can be thought of as a combination of high frequency sine waves. The maximum frequency component in a square wave pulse can be calculated by this equation:

$$f = 0.35/\text{rise time}$$

where

$$f = \text{GHz when "t" is in nanoseconds}$$

Attenuation of the frequencies necessary to support the short risetime will produce a slower rise and possibly prohibit the pulse from ever reaching the detector. This 'slurring' of the pulse is similar to the behavior of an RC circuit and the attenuation is sometimes called capacitive attenuation.

A series of pulses can demonstrate resonance. If a portion of a pulse is reflected at each interface, it is possible for them to come together and add up to form a new phantom pulse.

The critical frequency here is the bit rate. Think of a sine wave with a frequency the same as the bit rate; if it will resonate in the cable, the pulses will also. Extra pulses caused by resonance might easily result in an error signal from the receiving system requesting a retransmittal. The final result would be a communication system that is much slower than intended.

Cut-off Frequency

The cut-off frequency of a coaxial transmission line is the frequency at which modes of energy transmission, other than the "TEM" mode, can be generated.

$$f_{co} = \frac{7.5}{\sqrt{\epsilon} (D+d)} \text{ (in GHz)}$$

(D and d are measured in inches)

Types of Transmission Lines

Twin Lead transmission cable is generally used where impedance matching alone is important, since it provides only minimal shielding. Impedance values of 300 ohms and 600 ohms are common. Lower impedance values require closer spacing of the conductors and are not normally available in this type of cable. A typical application for twin lead cable is in antenna lead wire for television sets.

Twisted Pair is a variation of the twin lead type. It consists of two lengths of ordinary hookup wire twisted together. A twisted pair provides relatively constant impedance plus better magnetic shielding than twin lead cables. It is flexible, inexpensive, easy to terminate and is used extensively by the computer industry. However, it should not be used when maximum shielding is required.

Shielded Twisted Pair Cable is used to eliminate inductive and capacitive coupling. Twisting cancels out inductive coupling, while the shield eliminates capacitive coupling. Most applications for this cable are between equipment, racks and buildings.

Flexible (Braided) Coaxial Cable is by far the most common type of closed transmission line because of its flexibility. It is a coaxial cable, meaning that both the signal and the ground conductors are on the same center axis. The outer conductor is made from fine braided wire, hence the name "braided coaxial cable". This type of cable is used in practically all applications requiring complete shielding of the center conductor. The effectiveness of the shielding depends upon the weave of the braid and the number of braid layers. Tyco Electronics manufacturers connectors for cable sizes ranging from less than 1/8 in. diameter, for low power applications of around 50 watts, to over 1/2 in. diameter for power of 850 watts at 100 MHz and voltages up to 5000. In addition to power handling capabilities, cables are available for high frequency applications, high and low temperature applications, severe environmental applications and many other specialized uses.

Triaxial Cable is used when higher "shielding" efficiency characteristics are required in applications similar to those using shielded twisted pair cable.

Often you will hear the term "shielded cable". This is very similar to coaxial cable except the spacing between center conductor and shield is not carefully controlled during manufacture, resulting in non-constant impedance.

Semi-rigid Coaxial Cable uses a solid tubular outer conductor rather than the braided type, so that all the RF energy is contained within the cable. One of the drawbacks of braided cable is that the shielding is not 100% effective, especially at higher frequencies. This is because the braided construction can permit small amounts of short wavelength (high frequency) energy to radiate. Normally this does not present a problem; however, if a higher degree of shielding is required, semi-rigid coaxial cable is recommended. For applications using frequencies higher than 30 GHz a miniature semi-rigid cable is recommended. Various connectors are available from Tyco Electronics to terminate these cables.

Ribbon Coaxial Cable is a relatively recent Tyco Electronics innovation which combines the advantages of both ribbon cable and coaxial cable. Tyco Electronics currently provides both the cable and the insulation displacing coaxial connector to terminate the cable. Each individual coaxial cable consists of the signal conductor, dielectric, a foil shield and a drain wire which is in continuous contact with the foil. The entire assembly is then covered with an outer insulating jacket. The unique manufacturing feature of this cable is the precise placement of the drain wires to permit gang stripping of the outer jacket and foil. The major advantage of this cable is the speed and ease with which it can be mass terminated with the AMP insulation displacement technique. They can also be separated into individual coaxial lines and terminated with standard coaxial connectors as required.

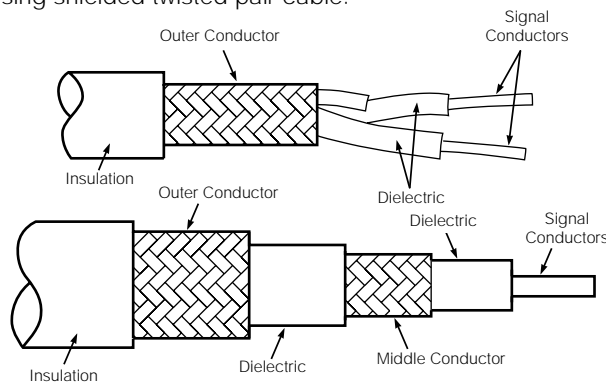

Figure 18

Twin Conductor and Triaxial Cable

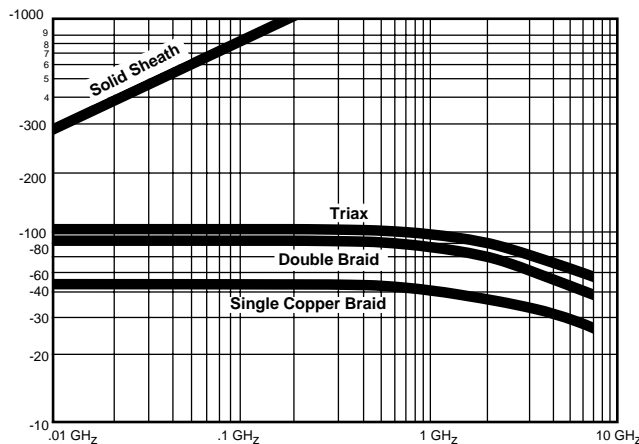

Figure 19

Shielding Efficiencies

Abbreviations

Dielectric

PESolid polyethylene
 PTEESolid polytetrafluoroethylene
 PIBPolyisobutylene, Type B, per MIL-C-17
 RubberPer MIL-C-17D
 SilSilicone rubber
 PSPolystyrene

Conductors and Braid Materials

ALAluminum
 SCAALSilver covered copper covered aluminum
 BCBare copper
 SCSilver covered copper
 CCSCopper covered steel
 TCTinned copper
 SCCSSilver covered copper covered steel

SCCad BrSilver covered cadmium bronze
 GSGalvanized steel
 TCCSTin copper covered steel
 SSCSilver covered strip
 HRHigh resistance wire
 SASilver covered alloy

Jacket Material

PVC-IBlack polyvinylchloride, contaminating, Type I, per MIL-C-17D
 PVC-IIGray polyvinylchloride, noncontaminating, Type II, per MIL-C-17D
 PVC-IIABlack polyvinylchloride, noncontaminating, Type IIA, per MIL-C-17D
 PE-IIIClear polyethylene
 PE-III AHigh molecular weight, black polyethylene, Type IIIA, per MIL-C-17D
 FG Braid VFiberglass, impregnated, Type V, per MIL-C-17D
 FEP-IXFluorinated ethylene propylene, Type IX, per MIL-C-17D
 PURPolyurethane, black specific compounds
 SIL/DAC-VIDacron braid over silicone rubber, Type VI, per MIL-C-17D
 RubberPer MIL-C-17D

RG/U Type Cable	Inner Conductor	Dielectric Material	DOD	Number/Type of Shielding Braids	Jacket Material	O.D.	Weight (lb/ft)	Nom. Imped. (Ohms)	Nom. Cap pf/ft	Max. Operating Temp. (C°)	Max. Operating Voltage (Volts RMS)	Comments
8	2.17 .0855 7/0.72 BC .0285	PE	7.24 .285	1/BC	PVC-I	10.29 .405	.106	52	29.5	-40 +80	4000	Use RG213
8A	2.17 .0855 7/0.72 BC .0285	PE	7.24 .285	.285 1/BC	PVC-IIA	10.29 .405	.106	52	29.5	-40 +80	5000	Use RG213
9	2.17 .0855 7/0.72 SC .0285	PE	7.11 .280	2/Inner SC Outer BC	PVC-II	10.67 .420	.140	51	30.0	-40 +80	4000	Use RG214
9A	2.17 .0855 7/0.72 SC .0285	PE	7.11 .280	2/SC	PVC-II	10.67 .420	.140	51	30.0	-40 +80	4000	Use RG214
9B	2.17 .0855 7/0.72 SC .0285	PE	7.11 .280	2/SC	PVC-IIA	10.67 .420	.150	50	30.8	-40 +80	5000	Use RG214
11	1.21 .0477 7/0.4 TC .0159	PE	7.24 .285	1/BC	PVC-I	10.29 .405	.096	75	20.6	-40 +80	4000	Use up to 100 MHz
11A	1.21 .0477 7/0.4 TC .0159	PE	7.24 .285	1/BC	PVC-IIA	10.29 .405	.096	75	20.6	-40 +80	5000	Use up to 1000 MHz
55	0.81 BC .0320	PE	2.95 .116	2/TC	PE-III	5.08 .200	.032	53.5	28.5	-55 +80	1900	Use RG55B
55A	0.89 SC .0350	PE	2.95 .116	2/SC	PVC-IIA	5.08 .200	.034	50	30.8	-40 +80	1900	Use RG223
55B	0.81 SC .0320	PE	2.95 .116	2/TC	PE-III A	5.08 .200	.033	53.5	28.5	-55 +80	1900	Use up to 1000 MHz
58	0.81 BC .0320	PE	2.95 .116	1/TC	PVC-I	4.95 .195	.029	53.5	28.5	-40 +80	1900	Use RG58B
58A	0.9 .0355	PE	2.95 .116	1/TC	PVC-I	4.95 .195	.029	52	28.5	-40 +80	1900	Use RG58C
58B	0.81 BC .0320	PE	2.95 .116	1/TC	PVC-IIA	4.95 .195	.029	53.5	28.5	-40 +80	1900	Use up to 1000 MHz
58C	0.9 .0355 19/0.8 TC .0071	PE	2.95 .116	1/TC	PVC-IIA	4.95 .195	.029	50	30.8	-40 +80	1900	Extra Flexible Version RG58B
59	0.64 CCS .0253	PE	3.71 .146	1/BC	PVC-I	6.15 .242	.032	73	21.0	-40 +80	2300	Use RG59B
59A	0.64 CCS .0253	PE	3.71 .146	1/BC	PVC-IIA	6.15 .242	.032	73	21.0	-40 +80	2300	Use RG59B
59B	0.58 CCS .0230	PE	3.71 .146	1/BC	PVC-IIA	6.15 .242	.032	75	20.6	-40 +80	2300	Use up to 1000 MHz

Appendix B - Typical Coaxial Cable Specifications

RG/U Type Cable	Inner Conductor	Dielectric Material	DOD	Number/Type of Shielding Braids	Jacket Material	O.D.	Weight (lb/ft)	Nom. Imped. (Ohms)	Nom. Cap pf/ft	Max. Operating Temp. (C°)	Max. Operating Voltage (Volts RMS)	Comments
62A	0.64 CCS .0253	Air-space PE	3.71 .146	1/BC	PVC-IIA	6.15 .242	.038	93	13.5	-40 +80	750	Capacitance
62B	0.61 .0240 7/0.2 CCS .0080	Air-space PE	3.71 .146	1/BC	PVC-IIA	6.15 .242	.038	93	13.5	-40 +80	750	Extra Flexible RG62A
71	0.64 CCS .0253	Air-space PE	3.71 .146	2/TC	PVC-I	6.22 .245	.046	93	13.5	-40 +80	750	Use RG71B
71A	0.64 CCS .0253	Air-space PE	3.71 .146	2/TC	PE-III	6.22 .245	.046	93	13.5	-55 +80	750	Use RG71B
71B	0.64 CCS .0253	Air-space PE	3.71 .146	2/TC	PE-IIIA	6.22 .245	.046	93	13.5	-55 +80	750	Low Capacitance
122	0.76 .0300 7/0.13 TC .0050	PE	2.44 .096	1/TC	PVC-IIA	4.06 .160	.016	50	29.4	-40 +80	1900	Use up to 1000 MHz
124	0.64 TCCS .0253	Taped PTFE	3.43 .135	1/TC	FG Braid-V	6.1 .240	.210	73	20.3	-55 +250	2300	Use RG140
140	0.64 SCCS .0250	PTFE	3.71 .146	1/SC	FG Braid-V	5.92 .233	.056	75	19.5	-55 +250	2300	See RG302 for FEP Jacket
141	0.91 SCCS .0359	PTFE	2.95 .116	1/SC	FG Braid-V	4.83 .190	.036	50	29.4	-55 +250	1900	Use RG141A
141A	0.99 SCCS .0390	PTFE	2.95 .116	1/SC	FG Braid-V	4.83 .190	.036	50	29.4	-55 +250	1900	See RG303 for FEP Jacket
142	0.91 SCCS .0359	PTFE	2.95 .116	2/SC	FG Braid-V	4.95 .195	.047	50	29.4	-55 +250	1900	Use RG142A
142A	0.99 SCCS .0390	PTFE	2.95 .116	2/SC	FG	4.95 .195	.047	50	29.4	-50 +250	1900	See RG142B for FEP Jacket
142B	0.99 SCCS .0390	PTFE	2.95 .116	2/SC	FEP	4.95 .195	.047	50	29.4	-55 +250	1900	Standard Center Cond. Available
174	0.48 .0189 7/0.16 CCS .0063	PE	1.52 .060	1/TC	PVC	2.54 .100	.008	50	30.8	-40 +80	1500	Miniature Data Transmission
178	0.3 .0120 7/0.1 SCCS .0040	PTFE	0.91 .036	1/SC	KEL-F	1.83 .072	.0054	50	29.4	-40 +150	1000	Use RG178B
178B	0.3 .0120 7/0.1 SCCS .0040	PTFE	0.86 .034	1/SC	FEP-IX	1.83 .072	.0054	50	29.4	-55 +200	1000	High Strength Cond. Available
179	0.3 .0120 7/0.1 SCCS .0040	PTFE	1.45 .057	1/SC	KEL-F	2.54 .100	.010	70	20.4	-55 +150	1200	Use RG179B
180B	0.3 .0120 7/0.1 SCCS .0040	PTFE	2.59 .102	1/SC	KEP-IX	3.56 .140	.019	95	15.4	-55 +200	1500	High Strength Cond. Available
188	0.51 .0201 7/0.17 SCCS .0067	PTFE	1.52 .060	1/SC	PTFE	2.67 .105	.011	50	29.4	-55 +250	1200	Use RG316
188A	0.51 .0201 7/0.17 SCCS .0067	PTFE	1.52 .060	1/SC	PTFE	2.67 .105	.011	50	29.4	-55 +250	1200	Use RG316
195A	0.3 .0120 7/0.1 SCCS .004	PTFE	2.59 .102	1/SC	PTFE	3.68 .145	.020	95	15.4	-55 +250	1500	Use RG180B
210	0.64 SCCS .0253	Air-Space PTFE	3.71 .146	1/SC	FG Braid-V	6.15 .242	.040	93	13.5	-55 +250	750	High Temp. Low Capacitance
213	2.26 .0888 7/0.75 BC .0296	PE	7.24 .285	1/BC	PVC-IIA	10.29 .405	.099	50	30.8	-40 +80	5000	Use up to 1000 MHz
214	2.26 .0888 7/0.75 SC .0296	PE	7.24 .285	2/SC	PVC-IIA	10.0 .425	.126	50	30.8	-40 +80	5000	Use up to 10,000 MHz

Appendix B - Typical Coaxial Cable Specifications (Continued)

RG/U Type Cable	Inner Conductor	Dielectric Material	DOD	Number/Type of Shielding Braids	Jacket Material	O.D.	Weight (lb/ft)	Nom. Imped. (Ohms)	Nom. Cap pf/ft	Max. Operating Temp. (C°)	Max. Operating Voltage (Volts RMS)	Comments
216	1.21 .0477 7/0.75 BC .0159	PE	7.24 .285	2/BC	PVC-IIA	10.8 .425	.114	75	20.6	-40 +80	5000	Use up to 1000 MHz
223	0.89 SC .035	PE	2.95 .116	2/SC	PVC-IIA	5.36 .211	.034	50	30.8	-40 +80	1900	Use up to 10,000 MHz
225	2.38 .0936 7/0.79 SC .0312	PTFE	7.24 .285	2/SC	FG Braid-V	10.92 .430	.180	50	29.4	-55 +250	5000	See RG393 for FEP Jacket
302	0.64 SCCS .0250	PTFE	3.71 .146	1/SC	FEP-IX	5.11 .201	.030	75	19.5	-55 +200	2300	FEP Jacketed RG140
303	0.99 SCCS .0390	PTFE	2.95 .116	1/SC	FEP-IX	4.32 .170	.088	50	29.4	-55 +200	1900	FEP Jacketed RG141A
316	0.51 .0201 7/0.17 SCCS .0067	PTFE	1.52 .060	1/SC	FEDP-IX	2.59 .102	.012	50	29.4	-55 +200	1200	FEP Jacketed RG188A
400	0.98 .0385 19/0.2 SPC .0077	PTFE	2.95 .116	2/SC	FEP-IX	4.95 .195	.050	50	29.3	-55 +200	1900	—
402	0.91 SCCS .0360	PTFE	3.02 .119	3.58 OD .141 Copper Tube	None	3.58 .141	.032	50	29.3	-40 +125	2500	Semi-rigid
405	0.51 SCCS .0201	PTFE	1.68 .066	2.18 OD .086 Copper Tube	None	2.19 .0865	.015	50	29.4	-40 +125	1500	Semi-rigid

Average Input Power in Watts

RG/U Type Cable	Frequency in MHz								
	10	50	100	200	400	1,000	3,000	5,000	10,000
5, 5A, 5B	2,000	800	550	350	230	125	60	40	22
8, 8A, 10A, 213, 215	3,700	1,300	850	540	350	190	95	65	37
9, 9A, 9B, 214	3,700	1,300	850	540	350	190	95	65	37
11, 11A, 12, 12A, 13, 13A, 216	2,500	1,000	650	400	260	150	70	50	26
217	6,000	2,000	1,200	800	480	260	120	85	50
22, 22B	1,700	650	430	280	190	110	50	38	20
55, 55A, 55B, 223	800	310	205	137	90	53	28	20	10
58, 58B	730	280	180	125	85	50	25	17	—
58A, 58C	650	225	170	110	75	44	22	15	—
59, 59A, 59B	1,300	480	310	200	135	77	40	27	15
62, 62A, 71, 71A, 71B	1,300	480	310	200	135	77	40	27	15
62B	1,150	420	280	180	120	69	35	25	14
115, 115A, 165, 225, 393	25,000	9,500	6,300	4,300	2,800	1,700	880	620	350
108, 108A	340	145	100	70	50	30	15	—	—
122	540	205	140	90	60	35	18	12	—
140, 141, 141A, 142, 142B, 302, 303, 400, 402	9,000	3,500	2,400	1,600	1,100	650	350	245	140
143, 143A	11,500	4,600	3,200	2,100	1,450	850	460	330	190
144	25,000	9,500	6,300	4,300	2,800	1,700	880	620	350
161, 179, 179A, 179B, 187, 187A	1,600	780	570	420	310	200	110	76	41
174, 174A	170	72	50	36	25	16	—	—	—
178, 178A, 178B, 196, 196A	710	340	240	170	123	78	41	28	14
180, 180A, 180B, 195, 195A	2,500	1,100	800	570	400	250	135	93	50
188, 188A, 316	1,250	600	450	330	240	160	80	57	30
210	8,500	3,300	2,300	1,600	1,100	620	310	220	140

Note: Values above 3 GHz vary considerably depending on construction.

Conditions:

Ambient — 104°F [40°C]

Altitude — Sea level

Center Conductor Temperature — 176°F [80°C] for polyethylene, 392°F [200°C] for PTFE

Decibels per Hundred Feet

RG/U Type Cable	Frequency in MHz								
	10	50	100	200	400	1,000	3,000	5,000	10,000
5, 5A, 5B	.80	1.40	2.90	4.30	6.40	11.00	22.00	30.00	52.00
8, 8A, 10A, 213, 215	.66	1.50	2.20	3.20	4.60	9.00	19.00	28.00	47.00
9, 9A, 9B, 214	.66	1.50	2.20	3.20	4.60	9.00	19.00	28.00	47.00
11, 11A, 12, 12A, 13, 13A, 216	.66	1.50	2.20	3.20	4.60	9.00	19.00	28.00	—
217	.41	1.00	1.40	2.10	3.10	5.80	13.00	19.00	31.00
22, 22B	1.20	2.80	4.20	6.30	9.50	—	—	—	—
55, 55A, 55B, 223	1.35	3.00	4.30	6.00	8.80	16.50	36.00	51.00	85.00
58, 58B	1.20	3.10	4.60	7.00	10.00	17.50	38.00	—	—
58A, 58C	1.40	3.30	4.90	7.30	11.00	20.00	41.00	—	—
59, 59A, 59B	1.10	2.30	3.30	4.70	6.70	11.50	25.50	41.00	—
62, 62A, 71, 71A, 71B	.90	1.90	2.80	3.70	5.20	8.50	18.40	29.50	—
62B	.90	2.10	3.00	4.30	6.10	10.50	23.50	36.00	—
115, 115A, 165, 225, 393	.60	1.40	2.10	3.10	4.50	7.50	14.00	21.00	35.00
108, 108A	2.30	5.20	7.50	11.00	16.00	26.20	54.00	—	—
122	1.60	4.40	6.90	11.00	16.60	29.20	57.20	89.00	—
140, 141, 141A, 142, 142B, 302, 303, 400, 402	1.20	2.70	3.90	5.50	8.00	13.00	26.00	36.00	62.00
143, 143A	.85	1.80	2.50	3.80	5.70	9.70	18.10	26.10	40.70
144	.38	1.00	1.60	2.30	3.80	7.00	15.10	—	—
161, 179, 179A, 179B, 187, 187A	5.00	7.90	9.80	12.70	15.80	25.00	43.00	62.50	135.00
174, 174A	3.80	6.50	8.90	12.00	17.50	31.00	64.30	97.00	185.00
178, 178A, 178B, 196, 196A	5.30	10.00	13.30	20.00	27.50	45.00	78.00	115.00	172.00
180, 180A, 180B, 195, 195A	3.10	4.20	5.10	7.30	10.40	16.50	36.00	49.50	89.00
188, 188A, 316	3.80	7.90	11.50	15.00	20.00	30.00	58.00	79.00	133.00
210	.23	.58	.85	1.30	1.90	3.10	6.50	9.00	15.00

Note: Values above 3 GHz vary considerably depending on construction.

Conditions

Ambient —68°F [20°C]

