

ME 22,5 UT/FE BUS/ 5 GN

Order No.: 2908744

Illustration shows a fully mounted version of the electronic housing



<http://eshop.phoenixcontact.de/phoenix/treeViewClick.do?UID=2908744>

Housing base, 5-position integrated cross connector for parallel through contacting

Commercial data	
GTIN (EAN)	4017918160647
sales group	F051
Pack	10 pcs.
Customs tariff	85369010
Weight/Piece	0.05329 KG
Catalog page information	Page 577 (CC-2009)

Product notes

WEEE/RoHS-compliant since:
06/02/2005



<http://www.download.phoenixcontact.com>
Please note that the data given here has been taken from the online catalog. For comprehensive information and data, please refer to the user documentation. The General Terms and Conditions of Use apply to Internet downloads.

Technical data	
General	
Housing type	Component housing
Housing material	Polyamide
Color	green

Dimensions / positions

Length	99 mm
Width	22.5 mm
Number of positions	16
	24

Technical data

Ambient temperature (operation)	-40 °C ... 105 °C
Connection in acc. with standard	CUL
Nominal voltage U_N	300 V
Nominal current I_N	8 A
Indicator1	CUL1
Inflammability class acc. to UL 94	V0
Power dissipation at 20°C in the horizontal mounting position	6.1 W 12.1 W

Certificates / Approvals



Certification CUL, UL

CUL

Nominal voltage U_N	300 V
Nominal current I_N	8 A

UL

Nominal voltage U_N	300 V
Nominal current I_N	8 A

Accessories

Item	Designation	Description
Assembly		
2709176	ME B-12,5 3MSTBO GN	Filler plugs, for unoccupied terminal points
2907143	ME B-22,5 MKDSO GN	Filler plugs, for unoccupied terminal points
2907143	ME B-22,5 MKDSO GN	Filler plugs, for unoccupied terminal points

2907156	ME B-22,5 MSTBO GN	Filler plugs, for unoccupied terminal points
2907156	ME B-22,5 MSTBO GN	Filler plugs, for unoccupied terminal points
2854173	ME B-KA	Terminal cover, 1 strip covers up to 12 terminal points, for ME-BUS terminal opening, (male side)
2854173	ME B-KA	Terminal cover, 1 strip covers up to 12 terminal points, for ME-BUS terminal opening, (male side)
2935959	ME B-SA/NS 35	Terminal cover, 1 strip covers up to 12 terminal points, for ME-BUS male side, (female side)
2935959	ME B-SA/NS 35	Terminal cover, 1 strip covers up to 12 terminal points, for ME-BUS male side, (female side)
2908760	ME DH27 NS 35	Spacers, for protection of the input or output contacts for DIN rail NS 35, width [B] 27 mm
2909895	ME DH36 NS 35	Spacers, for protection of the input or output contacts for DIN rail NS 35, width [B] 36 mm
2906911	ME LPZS	PCB stop, for soldering onto PCB
2853899	ME-SAS	Shield connection clamp for printed circuit terminal block

Plug/Adapter

1734634	CP-MSTB	Keying profile, is inserted into the slot on the plug or inverted header, red insulating material
1734401	CR-MSTB	Coding section, inserted into the recess in the header or the inverted plug, red insulating material

Additional products

Item	Designation	Description
Assembly		
2907172	ME 22,5 OT-MKDSO GN	Housing upper part, for printed circuit terminal block connection
2907473	ME 22,5 OT-MKDSO SET	Housing upper part, complete with PCB termination blocks for full equipping. 16-pos., housing width: 22.5 mm
2907169	ME 22,5 OT-MSTBO GN	Upper part of housing, for COMBICON connection, double-level
2907444	ME 22,5 OT-MSTBO SET	Housing upper part, complete with 4 pairs of COMBICON headers and plugs
General		
2709558	ME 22,5 OT-1MSTBO GN	Upper part of housing, for COMBICON connection, single-level

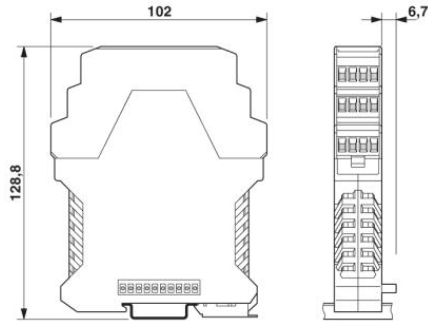

Dimensions of the electronics housing
 ME.../BUS 5 and ME.../BUS 10 with triple-
 level upper part

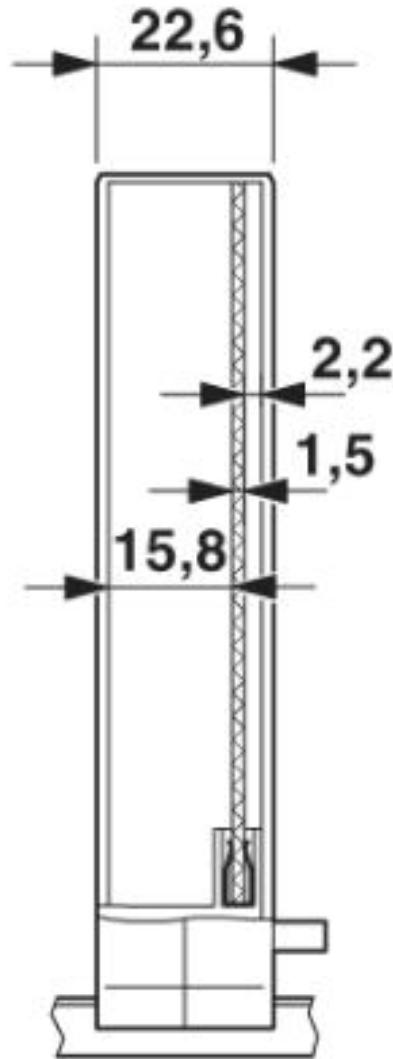

Internal housing dimensions, electronics
 housing ME 22.5 BUS...

Schematic diagram

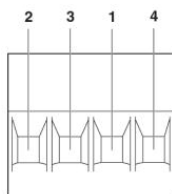

Pin assignment left

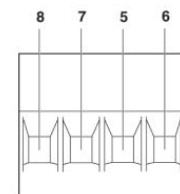
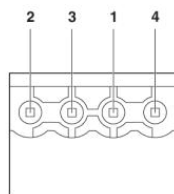

Pin assignment right

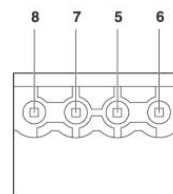

Address

PHOENIX CONTACT Inc., USA
586 Fulling Mill Road
Middletown, PA 17057, USA
Phone (800) 888-7388
Fax (717) 944-1625
<http://www.phoenixcon.com>



© 2010 Phoenix Contact
Technical modifications reserved;