

3M™ Mini D Ribbon (MDR) Connectors

I/O Mounting Hardware - Jacksockets

3341-XX Series

3M Part Number
3341-10

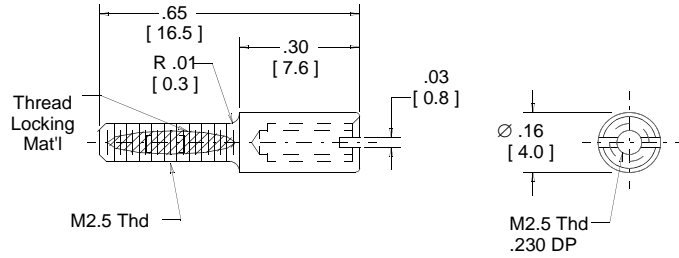

Material: ST. Steel
Plating: Passivated
Thread Size: M2.5/M2.5, 2.5 inch/lbs.
Package Size: 200 Pieces

3M Part Number
3341-16

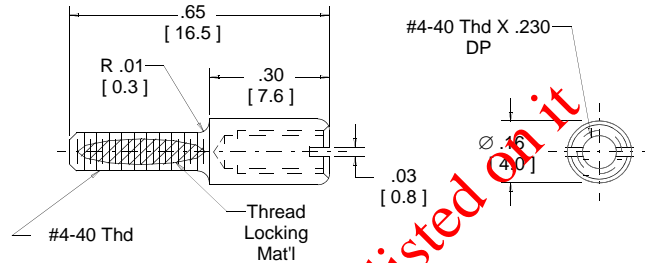

Material: ST. Steel
Plating: Passivated
Thread Size: #4-40/#4-40, 3.5 inch/lbs.
Package Size: 200 Pieces

3M Part Number
3341-17

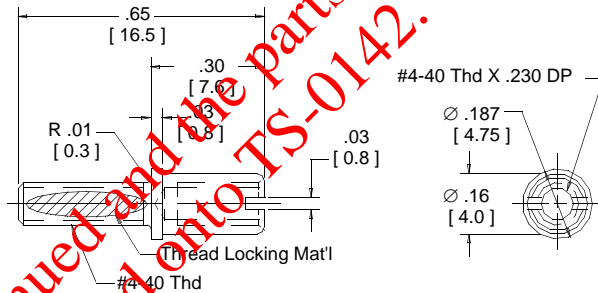

Material: ST. Steel
Plating: Passivated
Thread Size: #4-40/#4-40, 3.5 inch/lbs.
Package Size: 200 Pieces

3M Part Number
3341-13

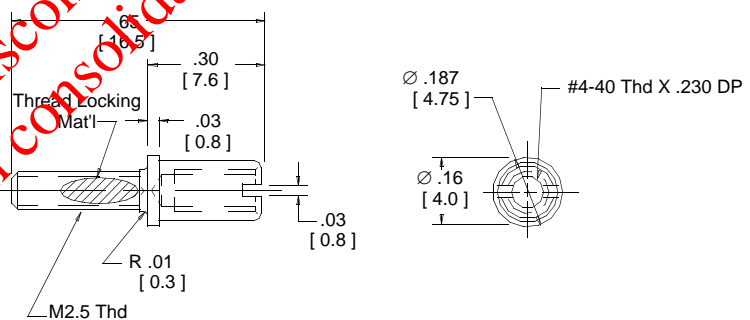

Material: ST. Steel
Plating: Passivated
Thread Size: M2.5/#4-40, 2.5 inch/lbs.
Package Size: 200 Pieces

3M Part Number
3341-25

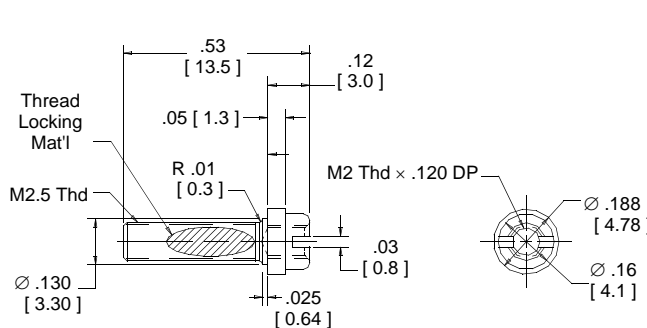

Material: ST. Steel
Plating: Passivated
Thread Size: M2.5/M2, 2.5 inch/lbs.
Package Size: 200 Pieces

Inch		
[mm]		
Tolerance Unless Noted		
	.0	.00
	.00	.000
inch	±.1	±.01
		±.005

[] Dimensions for Reference Only

TS-0502-10
Sheet 1 of 2

3M™ Mini D Ribbon (MDR) Connectors

I/O Mounting Hardware - Jacksockets

3341-XX Series

3M Part Number
3341-31

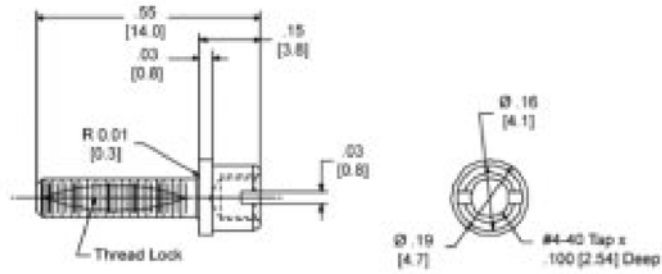

Material: ST. Steel
Plating: Passivated
Thread Size: M2.5/#4-40, 2.5 inch/lbs.
Package Size: 200 Pieces

3M Part Number
3341-32

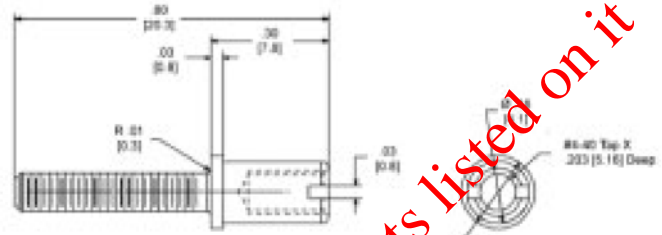

Material: ST. Steel
Plating: Passivated
Thread Size: M2.5/#4-40, 2.5 inch/lbs.
Package Size: 200 Pieces

Note: Parts shown are RoHS* compliant.
Date Modified: March 29, 2006

TS-0502 has been discontinued and the parts listed on it have been consolidated onto TS-0142.

RoHS = Directive 2002/95/EC, Restriction of the Use of Certain Hazardous Substances in Electrical and Electronic Equipment
"RoHS compliant" means that the product or part does not contain any of the following substances in excess of the following maximum concentration values in any homogeneous material: (a) 0.1% (by weight) for each of lead, mercury, hexavalent chromium, polybrominated biphenyls or polybrominated diphenyl ethers; or (b) 0.01% (by weight) for cadmium. Lead, mercury, cadmium, or hexavalent chromium may be present in the product or part in an exempt application as listed in the Annex to the RoHS Directive.

TS-0502-10
Sheet 2 of 2

Important Notice

All statements, technical information, and recommendations related to 3M's products are based on information believed to be reliable, but the accuracy or completeness is not guaranteed. Before using this product, you must evaluate it and determine if it is suitable for your intended application. You assume all risks and liability associated with such use. Any statements related to the product which are not contained in 3M's current publications, or any contrary statements contained on your purchase order shall have no force or effect unless expressly agreed upon, in writing, by an authorized officer of 3M.

3M

3M Electronics

6801 River Place Blvd.
Austin, TX 78726-9000
800/225-5373
www.3M.com/electronics

Warranty; Limited Remedy; Limited Liability.

This product will be free from defects in material and manufacture for a period of one (1) year from the time of purchase. **3M MAKES NO OTHER WARRANTIES INCLUDING, BUT NOT LIMITED TO, ANY IMPLIED WARRANTY OF MERCHANTABILITY OR FITNESS FOR A PARTICULAR PURPOSE.** If this product is defective within the warranty period stated above, your exclusive remedy shall be, at 3M's option, to replace or repair the 3M product or refund the purchase price of the 3M product. **Except where prohibited by law, 3M will not be liable for any indirect, special, incidental or consequential loss or damage arising from this 3M product, regardless of the legal theory asserted.**



Minimum 10%
Post-Consumer Fiber

Printed in USA.

© 3M 2006