

## Features

- RoHS compliant\*
  - Space saving design
  - Wide range of resistance values
  - PC pin or solder lug terminals
  - Metric shaft and bushing option
  - Mounting brackets available
- Linear or audio taper versions

## PC - "Slimline" 22 mm Square Single Turn Panel Control

### Electrical Characteristics

Standard Resistance Range	500 ohms to 1 megohm
Linear Tapers	1 K ohms to 500 K ohms
Audio Tapers	±20 %
Total Resistance Tolerance	±20 %
Independent Linearity	±5 %
Absolute Minimum Resistance	5 ohms maximum
Effective Electrical Angle	270 ° ± 5 °
Contact Resistance Variation	7 % of total resistance
Dielectric Withstanding Voltage (MIL-STD-202, Method 301)	
Sea Level	1,000 VAC minimum
70,000 Feet	500 VAC minimum
Insulation Resistance (500 V)	1,000 ohms minimum
Power Rating @ 70 °C (Voltage Limited by Power Dissipation or 350 VAC, Whichever is Less)	
Linear	.75 watt
Audio	.25 watt
Theoretical Resolution	Essentially infinite

### Environmental Characteristics

Operating Temperature Range	+1 °C to +125 °C
Storage Temperature Range	-40 °C to +125 °C
Temperature Coefficient Over Storage Temperature Range	±1000 ppm/°C
Vibration	.20 G
Total Resistance Shift	±1 % maximum
Voltage Ratio Shift	±20 % maximum
Shock	.50 G
Total Resistance Shift	±1 % maximum
Voltage Ratio Shift	±20 % maximum
Load Life	1,000 Hours @ Rated Power, 20 % RH, 70 °C
Total Resistance Shift	±10 % maximum
Rotational Life (No Load)	50,000 cycles
Total Resistance Shift (Linear taper)	±10 ohms or 12 %, whichever is greater
Total Resistance Shift (Audio taper)	±20 % maximum
Contact Resistance Variation	±5 % maximum
Moisture Resistance	MIL-STD-202, Method 103, Condition B
Total Resistance Shift	±20 % maximum
IP Rating	IP 40

### Mechanical Characteristics

Stop Strength (1/4 " and 6 mm Shaft Diameters)	79.09 N-cm (7 lb.-in.)
Mechanical Angle	300 ° ± 5 °
Torque	
Starting (Detented)	0.5-1.5 N-cm (0.75-2.25 oz.-in.)
Starting (Undetented)	1.5 N-cm (2.25 oz.-in.) maximum
Running (Undetented)	0.18 to 1.06 N-cm (0.25 to 1.5 oz.-in.)
Mounting	79.09 N-cm (7 lb.-in.) maximum
Weight (Single Section)	.21 gm (0.75 oz.) maximum
Terminals	PC pin or solder lug
Soldering Condition	
Manual Soldering	96.5Sn/3.0Ag/0.5Cu solid wire or no-clean rosin cored wire 370 °C (700 °F) max. for 3 seconds
Wave Soldering	96.5Sn/3.0Ag/0.5Cu solder with no-clean flux 260 °C (500 °F) max. for 5 seconds
Wash processes	Not recommended
Marking	Manufacturer's trademark, resistance value, part number, and date code
Ganging	1 cup maximum
Hardware	One lockwasher and one mounting nut is shipped with each potentiometer, except where noted in the part number.
Detents	Center, 10, 20, 30, none

For additional features or specifications not shown, consult factory.

FOR ORDERING INFORMATION SEE PAGE 4.

\*RoHS Directive 2002/95/EC Jan 27 2003 including Annex  
Specifications are subject to change without notice.

Customers should verify actual device performance in their specific applications.

# PC - "Slimline" 22 mm Square Single Turn Panel Control

**BOURNS®**

## Product Dimensions

### Axial PC Pins

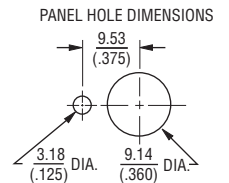
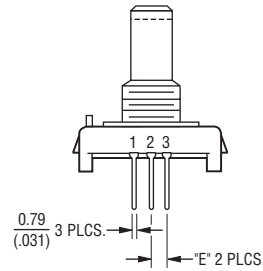
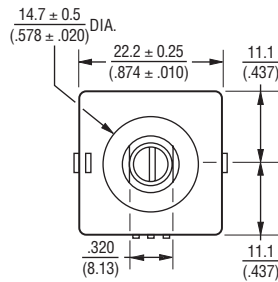
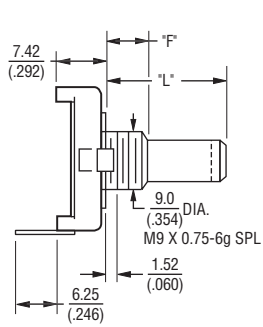

$${}^{\circ}F = \frac{6.35}{(.250)} \text{ OR } \frac{9.53}{(.375)} \quad {}^{\circ}E = \frac{2.54}{(.100)} \text{ OR } \frac{5.08}{(.200)}$$

\*L\* = SEE SHAFT LENGTH TABLE

### Radial PC Pins

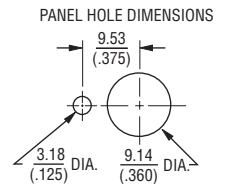
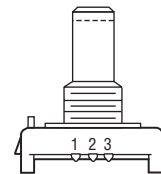
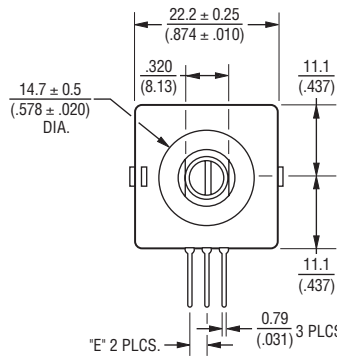
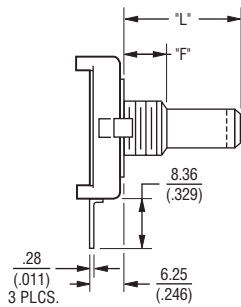

$${}^{\circ}F = \frac{6.35}{(.250)} \text{ OR } \frac{9.53}{(.375)} \quad {}^{\circ}E = \frac{2.54}{(.100)} \text{ OR } \frac{5.08}{(.200)}$$

\*L\* = SEE SHAFT LENGTH TABLE

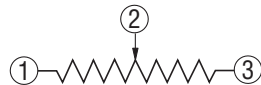

TOLERANCES EXCEPT WHERE NOTED:

$$.XX = \pm \frac{.25}{(.010)}$$

$$.XXX = \pm \frac{.13}{(.005)}$$

DIMENSIONS ARE:  $\frac{\text{MM}}{\text{(INCHES)}}$

# PC - "Slimline" 22 mm Square Single Turn Panel Control

**BOURNS®**

## Product Dimensions

### SOLDER LUGS

(Dimensions not given are the same as Axial PC pins.)

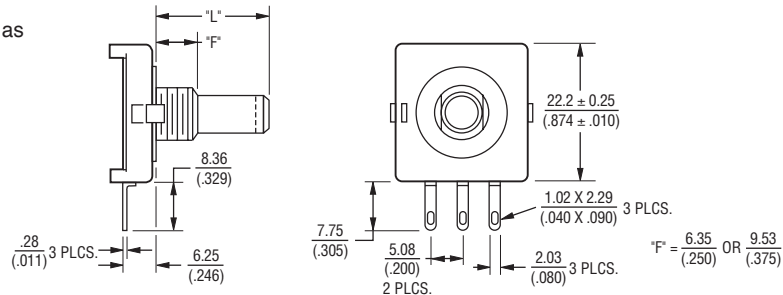

### Axial PC PINS With Rear Mounting Bracket

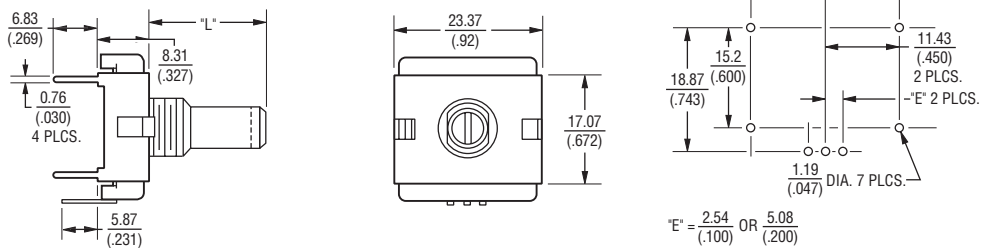

### Radial PC PINS With Side Mounting Bracket

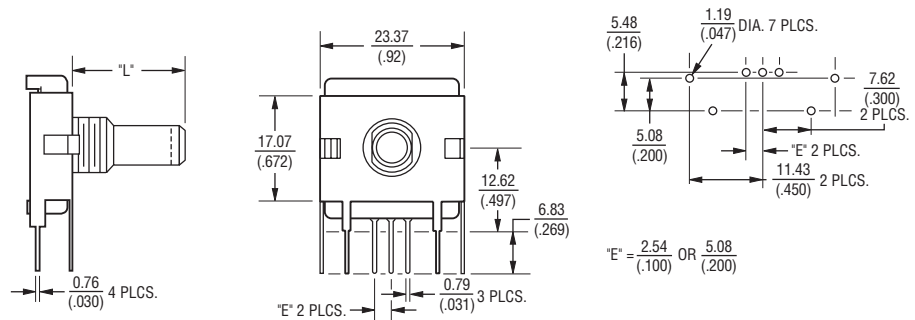

## SHAFT STYLES AND ORIENTATION (Full CCW Rotation)

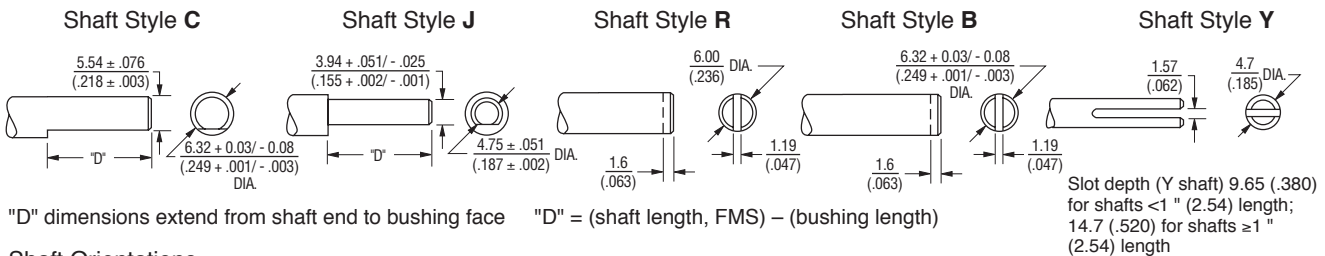

### Shaft Orientations

#### Shaft Styles C, J

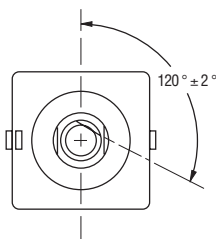

#### Shaft Styles B, R

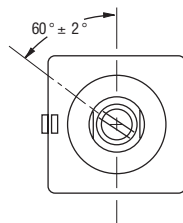

#### Shaft Style Y

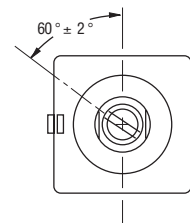

DIMENSIONS: MM (IN.)  
TOLERANCES EXCEPT WHERE NOTED:  
.XX = ± 0.25 (0.010)  
.XXX = ± 0.13 (0.005)

Specifications are subject to change without notice. Customers should verify actual device performance in their specific applications.

# How to Order PC "Slimline" Panel Controls

**BOURNS®**

P C W 1 J - B 2 4 - B A B 1 0 3 L

RoHS IDENTIFIER	
Code	Description
L	Compliant

SHAFT LENGTH (FMS)		
Code	Description	Available Shaft Styles
16	1/2 " (12.7 mm) Length	B
20	5/8 " (15.9 mm) Length	J
<b>24</b>	<b>3/4 " (19 mm) Length</b>	B, C, J, Y
<b>28</b>	<b>7/8 " (22.2 mm) Length</b>	B, C, J, Y
32	1 " (25.4 mm) Length	B, C, J, Y
36	1-1/8 " (28.6 mm) Length	B, C, J, Y
Metric		
19	19 mm Length	R
22	22 mm Length	R
<b>24</b>	<b>24 mm Length</b>	R

RESISTANCE VALUES					
Code	TR	Code	TR	Code	TR
501	500 Ω	<b>103</b>	<b>10 KΩ</b>	<b>104</b>	<b>100 KΩ</b>
102	1 KΩ	203	20 KΩ	254	250 KΩ
252	2.5 KΩ	253	25 KΩ	504	500 KΩ
<b>502</b>	<b>5 KΩ</b>	<b>503</b>	<b>50 KΩ</b>	105	1 MΩ

ELEMENT TAPER VERSIONS	
Code	Taper Description
<b>B</b>	<b>Lin. CP ±20 %</b>
D	CW Audio CP ±20 %
G	CCW Audio CP ±20 %

SHAFT STYLES (See Outline Drawing)	
Code	Description
<b>B</b>	<b>1/4 " (6.35 mm) Dia. Slotted</b>
C	1/4 " (6.35 mm) Dia. Flatted
J	3/16 " (4.76 mm) Dia. Flatted
<b>R</b>	<b>6 mm Dia. Slotted (Use Metric Lengths Only)</b>
Y	3/16 " (4.76 mm) Dia. Split Shaft

DETENT CONFIGURATIONS	
Code	Taper Description
<b>A</b>	<b>No Detents</b>
B	10 Detents
C	Center Detent Only
D	20 Detents
E	30 Detents
F	CCW Detent Only

ANTI-ROTATION LUG	
Code	Description
<b>J</b>	<b>9:00 Position</b>
D	None

NO. SECTIONS	
Code	Description
<b>1</b>	<b>Single</b>

BUSHING CONFIGURATION		
Code	Description	Available Shaft Styles
<b>W</b>	<b>9 mm x .250 " (6.35 mm) Length Threaded M9 x 0.75 6g 5 Pl</b>	All
L	9 mm x .375 " (9.53 mm) Length Threaded M9 x 0.75 6g 5 Pl	B, C, R

Features	HOUSING TERMINAL CONFIGURATION													
	Code													
	A	B	C	D	E	F	G	H	J	K	L	M	N	
Rear Mounting Bracket		<b>X</b>							X	X				X
Side Mounting Bracket					X		X					X	X	
Axial Terminals .100 " (2.54 mm) Centers	X	<b>X</b>									X			
Radial Terminals .100 " (2.54 mm) Centers				X	X							X		
Radial Terminals .200 " (5.08 mm) Centers						X	X						X	
Solder Lugs .200" (5.08 mm) Centers			X											
Axial Terminals .200 " (5.08 mm) Centers								X	X					X
Hardware Included	X		X	X		X		X		X	X	X	X	X

Panel mount hardware not included as standard on bracketed versions. The sample part number demonstrates the identification code for Bourns Slimline Potentiometers. The part number shown is a commonly used model, typically available from stock.

Boldface features are Bourns standard options. All others are available with higher minimum order quantities.



**Asia-Pacific:**  
Tel: +886-2 2562-4117 • Fax: +886-2 2562-4116  
**Europe:**  
Tel: +41-41 768 5555 • Fax: +41-41 768 5510  
**The Americas:**  
Tel: +1-951 781-5500 • Fax: +1-951 781-5700  
[www.bourns.com](http://www.bourns.com)

REV. 08/09

Specifications are subject to change without notice. Customers should verify actual device performance in their specific applications.