

3 line IPAD™, EMI filter for SIM card applications

Features

- SIM card EMI low-pass filter
- High efficiency in EMI filtering
- Very low PCB space consumption:
1.7 mm x 1.5 mm
- Very thin package: 0.6 mm max
- High efficiency in ESD suppression on external pins (IEC 61000-4-2 level 4).
- High reliability offered by monolithic integration
- High reduction of parasitic elements through integration and wafer level packaging.
- Lead free package
- Easy layout and flexibility thanks to I/O topology
- Low clamping voltage

Complies with following standards

- IEC 61000-4-2 level 4 external pins
 - 15 kV (air discharge)
 - 8 kV (contact discharge)
- IEC 61000-4-2 level 2 internal pins
 - 2 kV (air discharge)
 - 2 kV (contact discharge)
- MIL STD 883G - Method 3015-7 Class 3A (all pins)

Applications

Where EMI filtering in ESD sensitive equipment is required:

- Keyboard for mobile phones
- Computers and printers
- Communication systems
- MCU boards

TM: IPAD is a trademark of STMicroelectronics

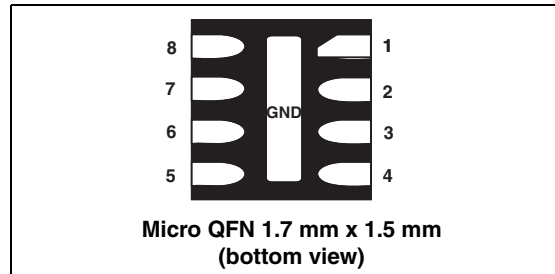

Figure 1. Pin configuration (top view)

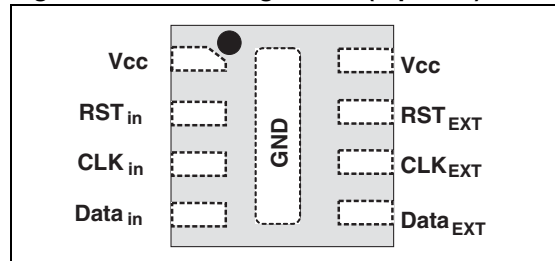
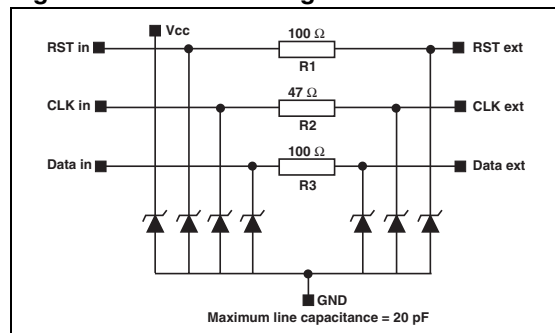

Figure 2. Device configuration



Description

The EMIF03-SIM02M8 is a 3 line highly integrated device designed to suppress EMI/RFI noise in all systems exposed to electromagnetic interference.

This filter includes ESD protection circuitry, which prevents damage to the application when subjected to ESD surges up to 15 kV on the external pins.

1 Characteristics

Table 1. Absolute ratings (limiting values at $T_{amb} = 25\text{ }^{\circ}\text{C}$ unless otherwise specified)

Symbol	Parameter	Value	Unit
V_{PP}	Internal pins		
	ESD discharge IEC 61000-4-2 air discharge	2	kV
	ESD discharge IEC 61000-4-2 contact discharge	2	
	External pins and V_{CC}		
	ESD discharge IEC 61000-4-2 air discharge	15	
ESD discharge IEC 61000-4-2 contact discharge	8		
T_j	All pins		
	MIL STD 883G - Method 3015-7 Class 3A (human body model)	4	
T_j	Junction temperature	125	$^{\circ}\text{C}$
T_{op}	Operating temperature range	-40 to + 85	$^{\circ}\text{C}$
T_{stg}	Storage temperature range	-55 to +150	$^{\circ}\text{C}$

Table 2. Electrical characteristics ($T_{amb} = 25\text{ }^{\circ}\text{C}$)

Symbol	Parameter				
V_{BR}	Breakdown voltage				
I_{RM}	Leakage current @ V_{RM}				
V_{RM}	Stand-off voltage				
V_{CL}	Clamping voltage				
I_{PP}	Peak pulse current				
$R_{I/O}$	Series resistance between input and output				
C_{line}	Input capacitance per line				
Symbol	Test conditions	Min.	Typ.	Max.	Unit
V_{BR}	$I_R = 1\text{ mA}$	6		7.9	V
I_{RM}	$V_{RM} = 3\text{ V}$			0.2	μA
R_1, R_3	Tolerance $\pm 20\%$		100		Ω
R_2	Tolerance $\pm 20\%$		47		Ω
C_{line}	$V_R = 0\text{ V}, F = 1\text{ MHz}, V_{OSC} = 30\text{ mV}$		17	20	pF

Figure 3. S21(db) attenuation (RST line)

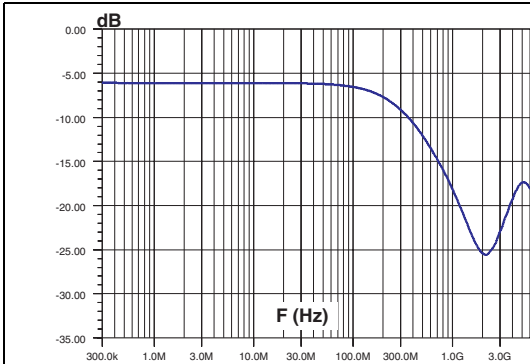

Figure 4. S21(db) attenuation (CLK line)

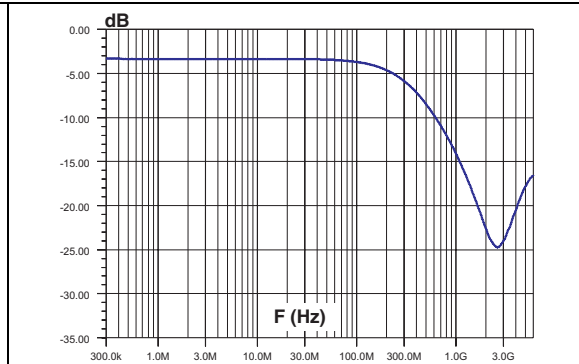

Figure 5. S21(db) attenuation (DATA line)

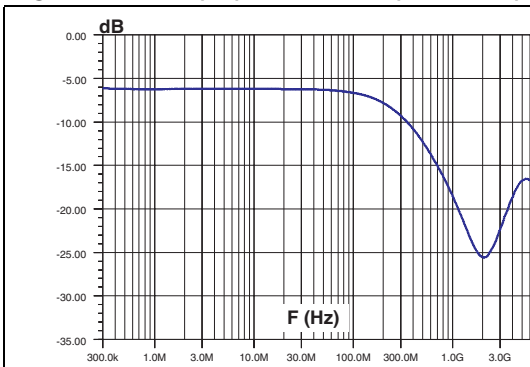

Figure 6. Analog cross talk measurements

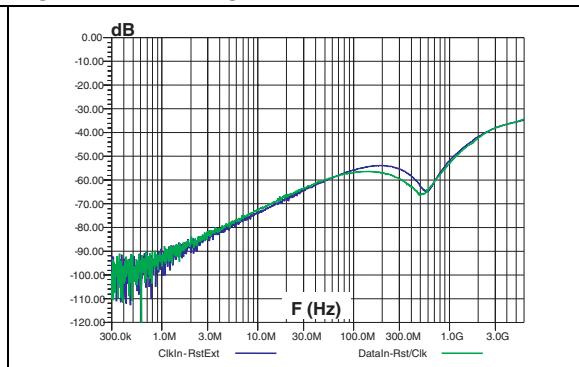

Figure 7. ESD response to IEC 61000-4-2 (+15 kV air discharge) applied to external pin

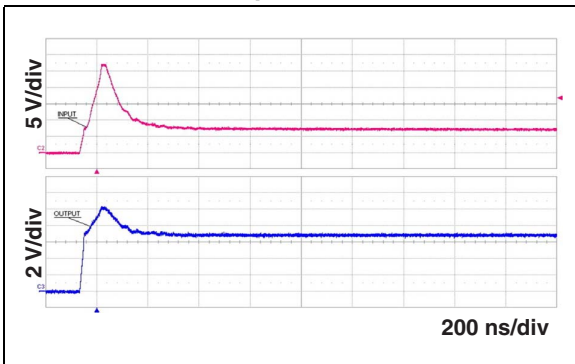

Figure 8. ESD response to IEC 61000-4-2 (-15 kV air discharge) applied to external pin

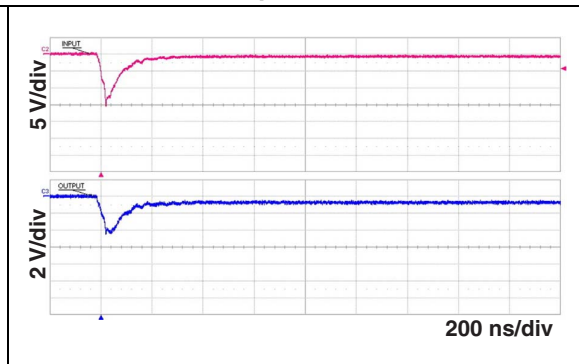

Figure 9. ESD response to IEC 61000-4-2 (+2 kV air discharge) applied to internal pin

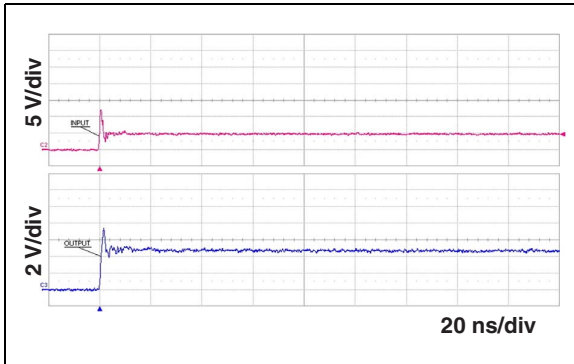
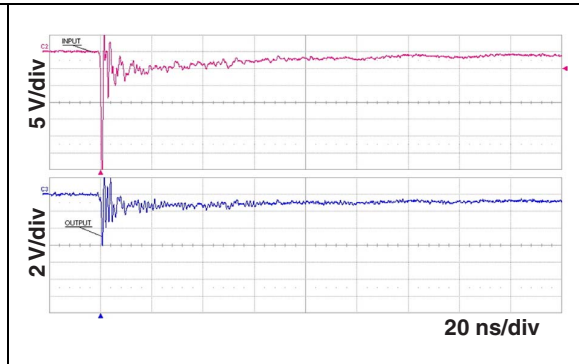
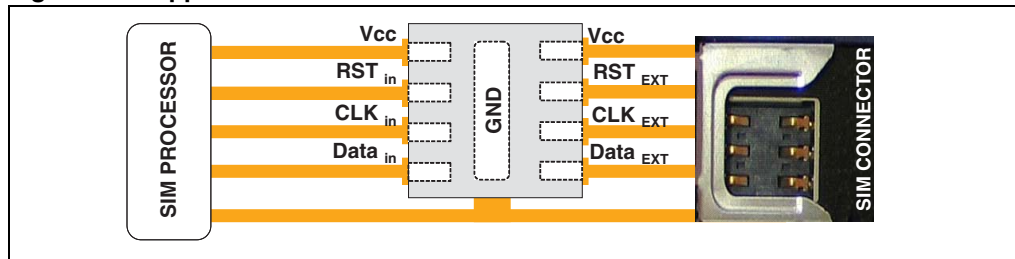

Figure 10. ESD response to IEC 61000-4-2 (-2 kV air discharge) applied to internal pin



2 Application schematic

Figure 11. Application schematic



3 Ordering information scheme

Figure 12. Ordering information scheme

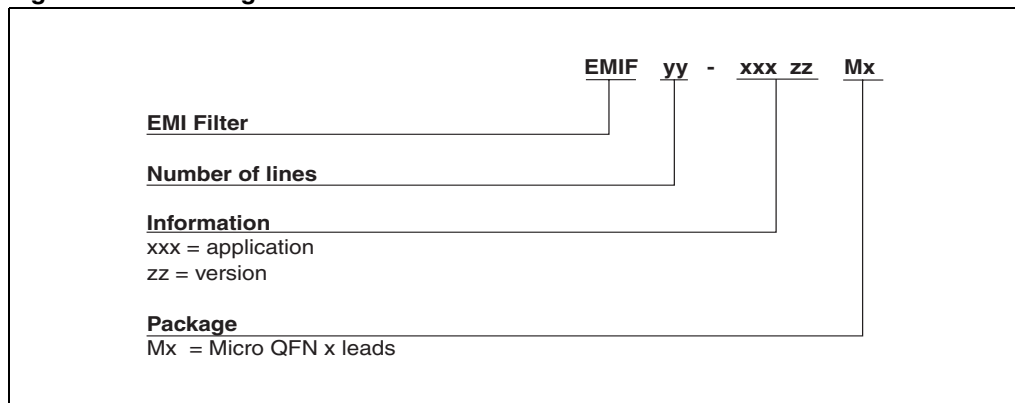

4 Package information

- Epoxy meets UL94, V0

In order to meet environmental requirements, ST offers these devices in ECOPACK® packages. These packages have a lead-free second level interconnect. The category of second level interconnect is marked on the inner box label, in compliance with JEDEC Standard JESD97. The maximum ratings related to soldering conditions are also marked on the inner box label. ECOPACK is an ST trademark. ECOPACK specifications are available at: www.st.com.

Table 3. QFN 1.7 x 1.5 package dimensions

Ref	Dimensions					
	Millimeters			inches		
	MIN	TYP	MAX	MIN	TYP	MAX
A	0.50	0.55	0.60	0.20	0.22	0.24
A1	0.00	0.02	0.05	0.00	0.01	0.02
b	0.15	0.18	0.25	0.06	0.07	0.10
D		1.70			0.67	
D2	0.9	1.00	1.10	0.35	0.39	0.43
E		1.50			0.59	
E2	0.30	0.40	0.50	0.12	0.16	0.24
e		0.40			0.16	
k	0.20			0.08		
L	0.25	0.30	0.35	0.10	0.12	0.14

Figure 13. Footprint (dimensions in mm) Figure 14. Marking

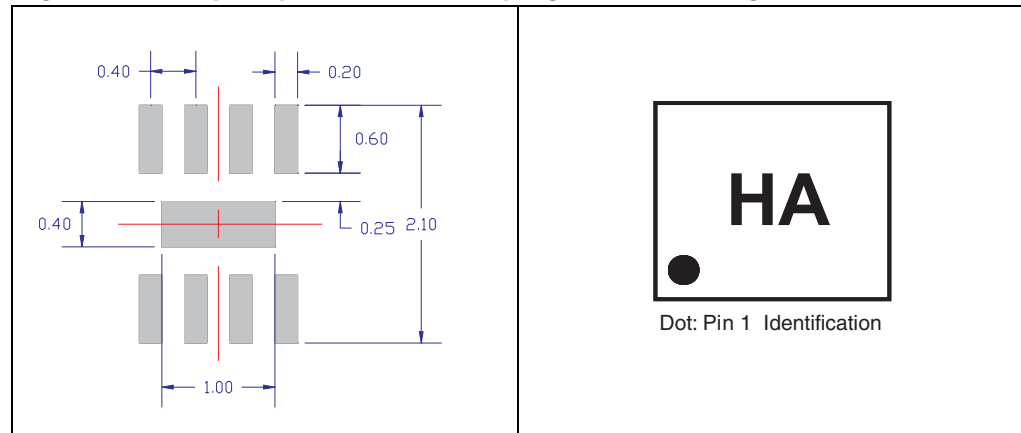
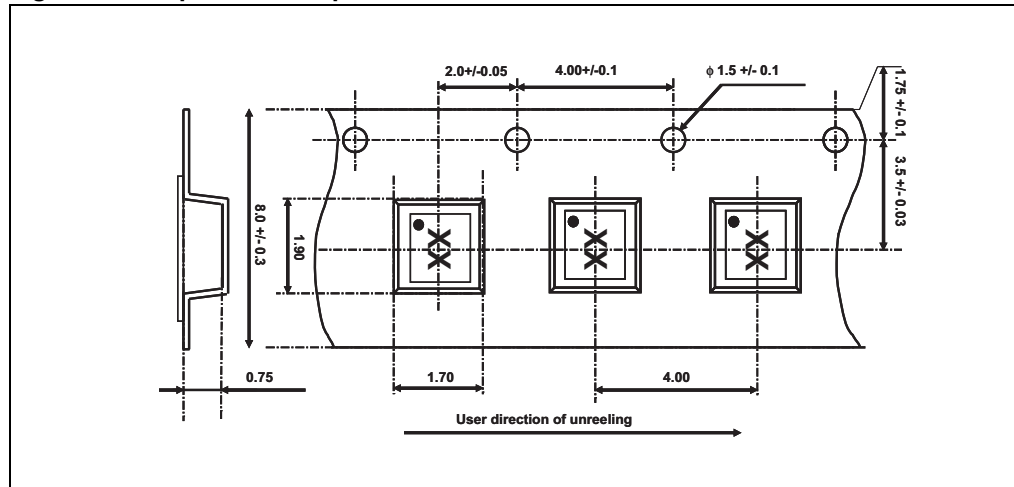

Figure 15. Tape and reel specification



Note: *Product marking may be rotated by 90° for assembly plant differentiation. In no case should this product marking be used to orient the component for its placement on a PCB. Only pin 1 mark is to be used for this purpose.*

5 Recommendation on PCB assembly

5.1 Stencil opening design

1. General recommendation on stencil opening design
 - a) Stencil opening dimensions: L (Length), W (Width), T (Thickness).

Figure 16. Stencil opening dimensions

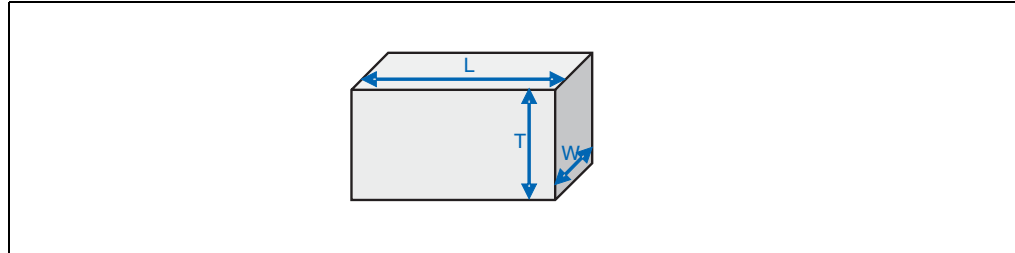

- b) General Design Rule

Stencil thickness (T) = 75 ~ 125 μm

$$\text{Aspect Ratio} = \frac{W}{T} \geq 1.5$$

$$\text{Aspect Area} = \frac{L \times W}{2T(L + W)} \geq 0.66$$
2. Reference design
 - a) Stencil opening thickness: 100 μm
 - b) Stencil opening for central exposed pad: Opening to footprint ratio is 50%.
 Example: Stencil opening L = 680 μm , W = 300 μm
 Footprint (see [Figure 13](#)) L = 1000 μm , W = 400 μm
 - c) Stencil opening for leads: Opening to footprint ratio is 90%.
 Example: Stencil opening L = 570 μm , W = 190 μm
 Footprint (see [Figure 13](#)) L = 600 μm , W = 200 μm

5.2 Solder paste

1. Halide-free flux qualification ROL0 according to ANSI/J-STD-004.
2. "No clean" solder paste is recommended.
3. Offers a high tack force to resist component movement during high speed
4. Solder paste with fine particles: powder particle size is 20-45 μm .

5.3 Placement

1. Manual positioning is not recommended.
2. It is recommended to use the lead recognition capabilities of the placement system, not the outline centering
3. Standard tolerance of ± 0.05 mm is recommended.
4. 3.5 N placement force is recommended. Too much placement force can lead to squeezed out solder paste and cause solder joints to short. Too low placement force can lead to insufficient contact between package and solder paste that could cause open solder joints or badly centered packages.
5. To improve the package placement accuracy, a bottom side optical control should be performed with a high resolution tool.
6. For assembly, a perfect supporting of the PCB (all the more on flexible PCB) is recommended during solder paste printing, pick and place and reflow soldering by using optimized tools.

5.4 PCB design preference

1. To control the solder paste amount, the closed via is recommended instead of open vias.
2. The position of tracks and open vias in the solder area should be well balanced. The symmetrical layout is recommended, in case any tilt phenomena caused by asymmetrical solder paste amount due to the solder flow away.

5.5 Reflow profile

Figure 17. ST ECOPACK® recommended soldering reflow profile for PCB mounting

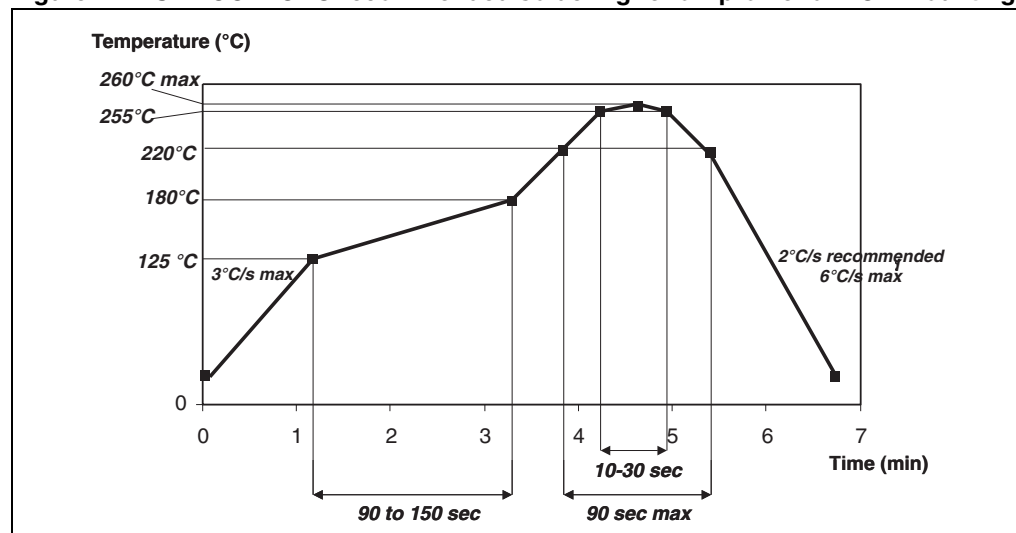

Note: Minimize air convection currents in the reflow oven to avoid component movement.

6 Ordering information

Table 4. Ordering information

Part number	Marking	Package	Weight	Base qty	Delivery mode
EMIF03-SIM02M8	HA	Micro QFN	4 mg	3000	Tape and reel (7")

7 Revision history

Table 5. Document revision history

Date	Revision	Changes
07-Oct-2007	1	Initial release.

Please Read Carefully:

Information in this document is provided solely in connection with ST products. STMicroelectronics NV and its subsidiaries ("ST") reserve the right to make changes, corrections, modifications or improvements, to this document, and the products and services described herein at any time, without notice.

All ST products are sold pursuant to ST's terms and conditions of sale.

Purchasers are solely responsible for the choice, selection and use of the ST products and services described herein, and ST assumes no liability whatsoever relating to the choice, selection or use of the ST products and services described herein.

No license, express or implied, by estoppel or otherwise, to any intellectual property rights is granted under this document. If any part of this document refers to any third party products or services it shall not be deemed a license grant by ST for the use of such third party products or services, or any intellectual property contained therein or considered as a warranty covering the use in any manner whatsoever of such third party products or services or any intellectual property contained therein.

UNLESS OTHERWISE SET FORTH IN ST'S TERMS AND CONDITIONS OF SALE ST DISCLAIMS ANY EXPRESS OR IMPLIED WARRANTY WITH RESPECT TO THE USE AND/OR SALE OF ST PRODUCTS INCLUDING WITHOUT LIMITATION IMPLIED WARRANTIES OF MERCHANTABILITY, FITNESS FOR A PARTICULAR PURPOSE (AND THEIR EQUIVALENTS UNDER THE LAWS OF ANY JURISDICTION), OR INFRINGEMENT OF ANY PATENT, COPYRIGHT OR OTHER INTELLECTUAL PROPERTY RIGHT.

UNLESS EXPRESSLY APPROVED IN WRITING BY AN AUTHORIZED ST REPRESENTATIVE, ST PRODUCTS ARE NOT RECOMMENDED, AUTHORIZED OR WARRANTED FOR USE IN MILITARY, AIR CRAFT, SPACE, LIFE SAVING, OR LIFE SUSTAINING APPLICATIONS, NOR IN PRODUCTS OR SYSTEMS WHERE FAILURE OR MALFUNCTION MAY RESULT IN PERSONAL INJURY, DEATH, OR SEVERE PROPERTY OR ENVIRONMENTAL DAMAGE. ST PRODUCTS WHICH ARE NOT SPECIFIED AS "AUTOMOTIVE GRADE" MAY ONLY BE USED IN AUTOMOTIVE APPLICATIONS AT USER'S OWN RISK.

Resale of ST products with provisions different from the statements and/or technical features set forth in this document shall immediately void any warranty granted by ST for the ST product or service described herein and shall not create or extend in any manner whatsoever, any liability of ST.

ST and the ST logo are trademarks or registered trademarks of ST in various countries.

Information in this document supersedes and replaces all information previously supplied.

The ST logo is a registered trademark of STMicroelectronics. All other names are the property of their respective owners.

© 2007 STMicroelectronics - All rights reserved

STMicroelectronics group of companies

Australia - Belgium - Brazil - Canada - China - Czech Republic - Finland - France - Germany - Hong Kong - India - Israel - Italy - Japan - Malaysia - Malta - Morocco - Singapore - Spain - Sweden - Switzerland - United Kingdom - United States of America

www.st.com