

Series 380, 53/RV4, 485

2 Watt, Conductive Plastic

Potentiometer

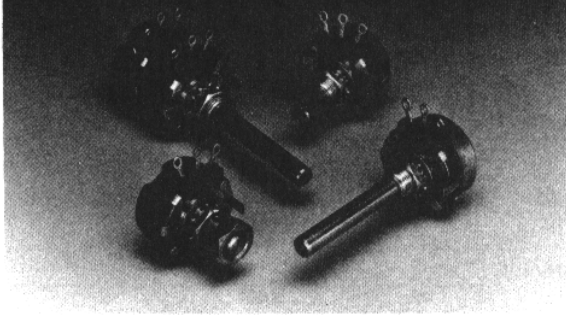

Description

The Series 380 "Quiet One" is a 2-watt conductive plastic potentiometer offering superior dynamic noise and a long rotational life. And it's manufactured to MIL-R-94 specifications where applicable.

Our 53/RV4 is a dual-marked potentiometer with all the fine features of the Series 380 in a more economical package. And it's built in strict accordance with MIL-R-94.

Series 485 has all the exceptional features of the 380 with a bonus of ten times the rotational life. (Special order only.)

Features

- **Series 380**
1% dynamic noise
100,000 cycle life
Stainless-steel shaft
- **Series 53/RV4**
Economical
Wide range of values and tapers
Shaft and mounting seals available
- **Series 485**
1% dynamic noise
1 million cycle life
Available on special order only

Series 380, 53/RV4, 485, Electrical Specifications

Resistance Range

50 Ω to 5 Megohms, linear.

250 Ω to 2.5 Megohms, tapered.

485 series only, 100 Ω to 2.5 Megohm, linear.

Resistance Tolerance

Linear, up to 1 Megohm $\pm 10\%$, above 1 Megohm $\pm 20\%$.

Tapers, up to 500K Ω $\pm 10\%$; above 500K Ω $\pm 20\%$.

Power Rating (Watts)

2 watts maximum continuous power rating for linear taper, but voltage not to exceed rating. Full rating @ 70°C, derated linearly to zero watts at 120°C.

Derate all non-linear tapers by multiplying wattage rating by 0.5. See Chart A, page 44.

Electrical Rotation

312° $\pm 3^\circ$ without switch; 333° $\pm 3^\circ$ with switch.

Effective Rotation

270°, -0°/ +10°

Tapers

Right or left-hand available.

See Chart B, page 45.

End Resistance

Linear units: 4 Ω maximum for total resistances up to 250K; 10 Ω for resistances 250K and higher.

Taper units: High end of element 1% of total resistance or 4 Ω whichever is greater; low end same as for linear units.

Dielectric Strength

1000 Vac for 60 seconds @ ATM pressure.

450 Vac for 60 seconds @ 3.4 in. Hg.

Working Voltage

500 Vdc across end terminals, but power not to exceed rating.

Resistance Temperature Characteristics

See Chart C, page 45.

Dynamic Noise

Linear single controls maximum initial noise level of 1% of total resistance. Measurement made using a constant current source and oscilloscope detection technique.

Static noise

See Chart D, page 45.

Linearity

$\pm 5\%$ independent — linear tapers only

Voltage Coefficient

.005%/Volt, maximum

Switch Characteristics

Rotary

See Chart E, page 47.

Mechanical Rotation

312° ±3° without switch; 333° ±3° with switch

Stop Torque Withstanding Strength

12 lb. in. minimum, single shaft

8 lb. in. minimum, concentric shaft

Torque Range

Single control 1 oz. in. to 4 oz. in., 2 oz. in. variation through mechanical rotation within a control.

Single control with shaft seal 1 oz. in. to 6 oz. in.

Single control with shaft locking feature and jam nut tightened to 10 lb. in. Starting torque is 30 oz. in.

Standard Bushing Lengths

Plain, 1/4 in. (6.35mm), 3/8 in. (9.53mm), 1/2 in. (12.7mm)

Panel Seal, 3/8 in. (9.53mm)

Shaft Locking, 1/2 in. (12.7mm)

Thread, 3/8 in. (9.53mm)-32 NEF-2A

Other bushings available on special order.

Standard Shafts (Single Control Only)

Standard diameter 1/4 in. (6.35mm). Standard lengths every 1/8 in. (3.18mm) from 3/8 in. (9.53mm) minimum to 5 in. (127 mm) maximum. 380, stainless steel.

53/RV4 and 485 brass, nickel-plated.

Available in round, slotted or flatted configurations. All shafts measured from mounting surface. Other shaft configurations available on special order.

Weight

Single .072 lbs. approximate

Hardware

Must be ordered separately.

(a) Hex mounting nut, 3/8 in. (9.53mm) x 32 -NEF-2A thread, 1/2 in. (12.7mm) across flats, 3/32 in. (2.38mm) thick.

(b) Internal tooth lockwasher, 11/16 in. (17.46mm) outer diameter. x .022 in. (0.56 mm) thick.

(c) Jam hex nut, 1/2 in. (12.7mm) across flats, 7/32 in. (5.56mm) thick, supplied on locking-type bushing.

Marking

Will appear on rear surface without switch. On periphery when switch is used. Unless otherwise specified, marking will consist of:

- Customer part number or Clarostat part number,
- EIA source and date code.

NOTE: SPECIFICATIONS SUBJECT TO CHANGE WITHOUT NOTICE.

Operating Temperature Range

-55°C to +120°C

Rotational Life (Standard)

Series 380: Rotational life for linear control; 100,000 cycles for units up to and including 100,000Ω, change not to exceed 5% R; above 100,000Ω change not to exceed 10% R.

Series 53/RV4: All resistance values: 25,000 cycles.

Series 485: 10% maximum change in total resistance as a result of 1,500,000 shaft rotations life test under full load for resistance values 1K to 2.5 Megohms; 1,000,000 shaft rotations under full load for resistance values 100Ω to 1KΩ

Figure 1

Chart A

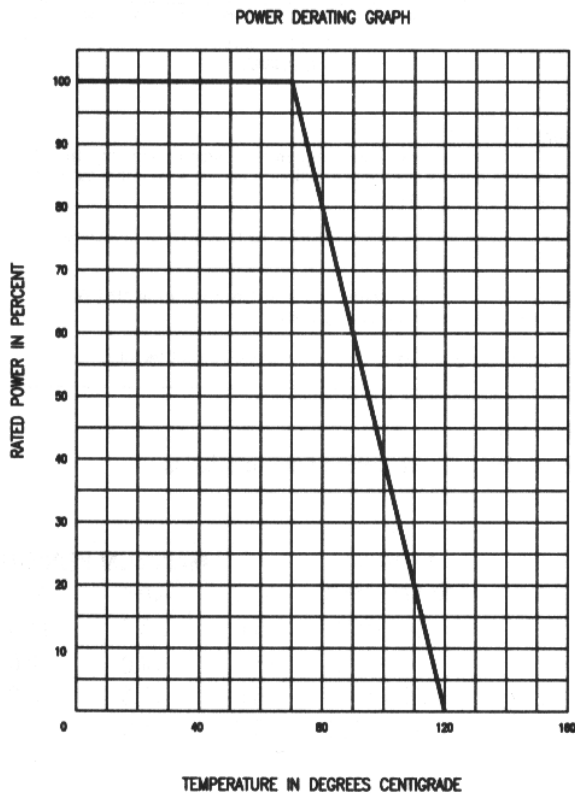
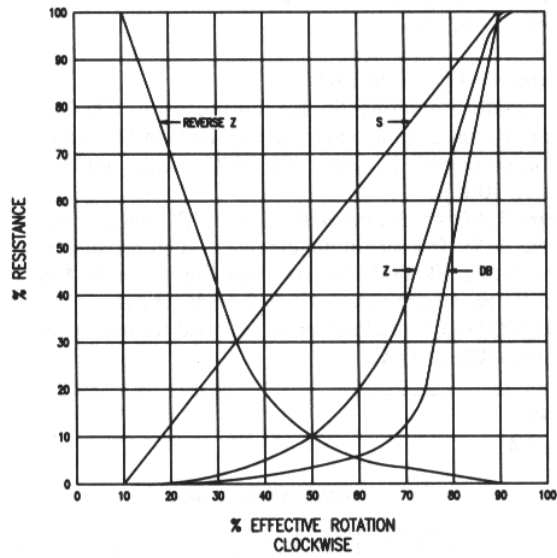

Figure 2

Chart B



Curve Standard

The "S" taper is linear, the change in resistance value being directly proportional to the degree of rotation. It can be used either as right-hand or left-hand taper.

The "Z" taper attains 10% resistance value at 50% of clockwise rotation (left-hand).

The reverse "Z" taper attains 10% resistance values at 50% of counter-clockwise rotation (right-hand).

For conformity and special output curves, consult factory.

Figure 3

Chart D

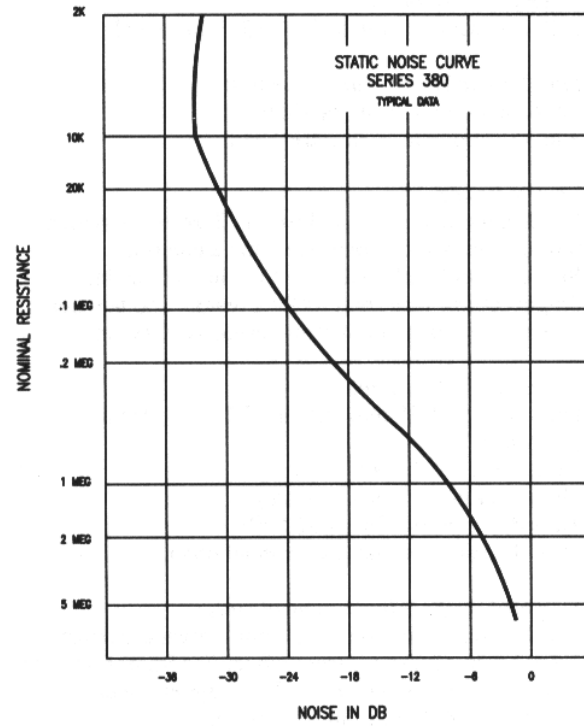

Chart C

Resistance Temperature Characteristics

| NOMINAL RESISTANCE | MAXIMUM PERCENT TEMPORARY RESISTANCE FROM 25°C | | | | | | |
|--------------------|--|-------|------|-------|-------|--------|--------|
| | -55°C | -40°C | 0°C | +25°C | +85°C | +105°C | +120°C |
| 100 OHMS | ±5.0 | ±3.0 | ±1.5 | 0 | ±1.5 | ±2.5 | ±3.5 |
| 10K OHMS | +5.5 | +4.0 | +2.0 | 0 | ±2.5 | ±3.0 | ±4.0 |
| 100K OHMS | +6.5 | +5.5 | +2.0 | 0 | ±3.0 | ±4.0 | ±5.5 |
| 1 MEGOHMS | +9.0 | +8.0 | +2.5 | 0 | ±3.5 | ±5.5 | ±7.0 |

Figure 4

Series 380, 53/RV4 Dimensions

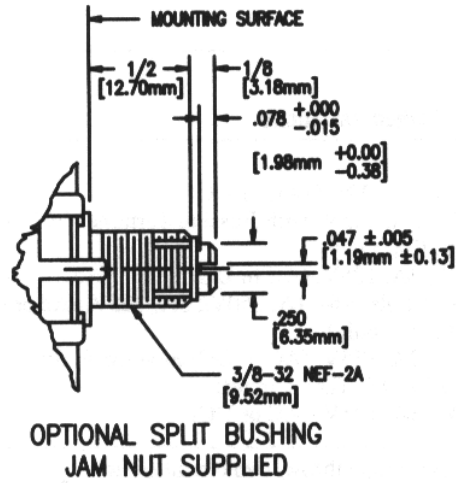
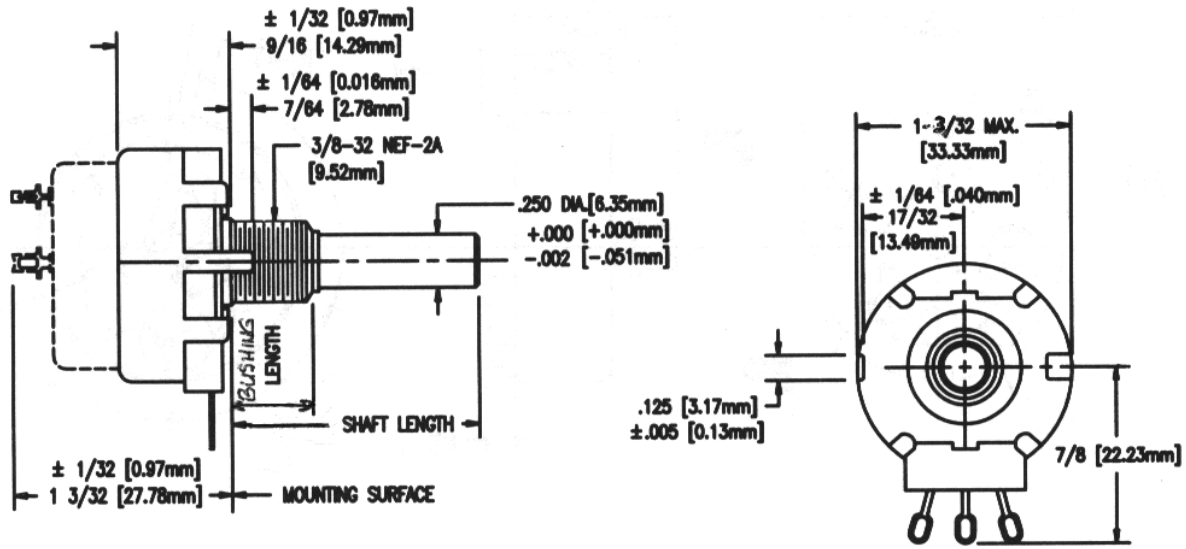
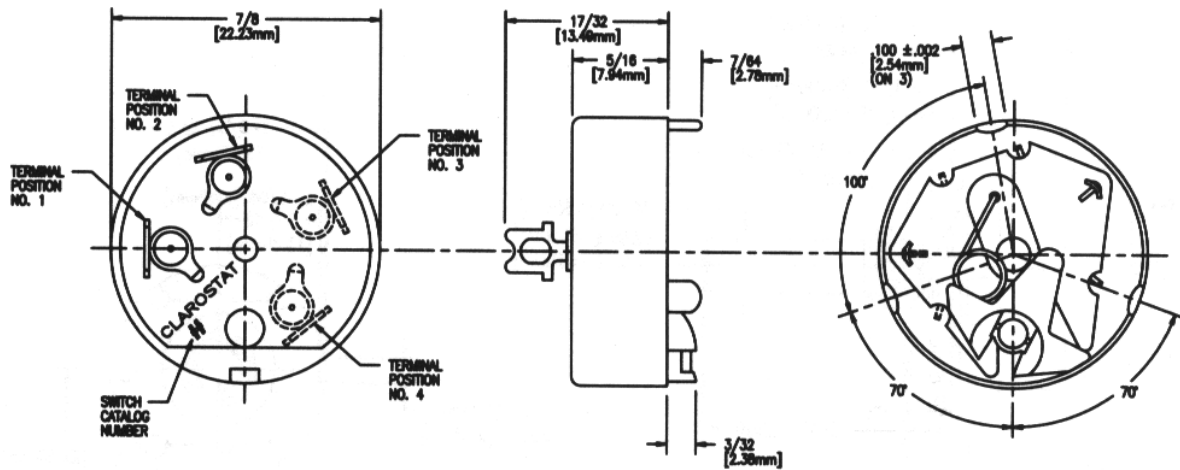

Figure 5
Chart E



| Type No. | Switch Variations | Terminal Positions | Max. Operating Torque-Oz. In. |
|----------|--|--------------------|-------------------------------|
| AE-10 | S.P.S.T. 1A, 250 V.; 3A, 125V (AC or DC) | 1-2 | 12 |
| AE-11 | S.P.S.T. 1A, 250V.; 3A, 125V. with Bussing Terminal (AC or DC) | 1-2-4 | 12 |
| AE-13 | S.P.S.T. 15A, 10V. (DC Only) | 1-4 | 16 |
| *AE-20 | D.P.S.T. 1A, 250V.; 3A, 125V. (AC or DC) | 1-2-3-4 | 16 |
| AE-21 | D.P. 1 Pole on, 1 Pole off—1A, 250V.; 3A, 125V. (Ac or DC) | 1-2-3-4 | 16 |
| AE-23 | D.P.S.T. 15A, 10V. (DC only) | 1-2-3-4 | 16 |
| *AE-24 | D.P.S.T. 1A, 250V.; 3A, 125V. (AC or DC) Reverse Action | 1-2-3-4 | 16 |
| AE-25 | D.P.S.T. 250MA. 24V.D.C. (Dry Circuit) | 1-2-3-4 | 12 |
| AE-30 | S.P.D.T. 1A, 250V.; 3A, 125V. (AC or DC) | 2-3-4 | 16 |

* May be employed as a single pole, single throw, two circuit switch.
To Designate this application add an "A" to the end of switch type.
Example: AE-20A

Series 380 Standard Resistance Values

Stock Values (Ohms) Series 380C1

| | | | | |
|------|-------|------|------|----------|
| 50 | 1000 | 10K | 100K | 1 meg |
| 100 | 1500 | 15K | 150K | 1.5 meg* |
| 150 | 2000 | 20K | 200K | 2 meg |
| 250 | 2500 | 25K | 250K | 2.5 meg* |
| 350* | 3500* | 35K | 350K | 3 meg* |
| 500 | 5000 | 50K | 500K | 3.5 meg* |
| 750* | 7500* | 75K* | 750K | 4 meg |
| | | | | 5 meg |

*Made-to-order; please consult Factory.

Stock Values (Ohms) Series 380C2

| | | | | |
|------|-------|------|-------|----------|
| 50* | 1000 | 10K | 100K | 1 meg |
| 100 | 1500* | 15K | 150K | 1.5 meg |
| 150 | 2000 | 20K | 200K* | 2 meg* |
| 250 | 2500 | 25K | 250K | 2.5 meg* |
| 350 | 3500 | 35K* | 350K | 3 meg* |
| 500 | 5000 | 50K | 500K | 3.5 meg |
| 750* | 7500* | 75K* | 750K* | 4 meg* |
| | | | | 5 meg |

*Made-to-order; please consult Factory.

Stock Values (Ohms) Series 380C3

| | | | | |
|------|-------|------|-------|----------|
| 50 | 1000 | 10K | 100K | 1 meg |
| 100 | 1500 | 15K | 150K | 1.5 meg |
| 150* | 2000 | 20K | 200K | 2 meg |
| 250 | 2500 | 25K | 250K | 2.5 meg |
| 350* | 3500 | 35K* | 350K* | 3 meg |
| 500 | 5000 | 50K | 500K | 3.5 meg* |
| 750* | 7500* | 75K | 750K | 4 meg |
| | | | | 5 meg |

*Made-to-order; please consult Factory.

Series 380 How To Order

| Catalog Number | Description |
|----------------|--|
| 380C1 | 2" round shaft FMS; 3/8" long bushing with 3/8 x 32-NEF-2A thread. |
| 380C2 | 5/8" screwdriver slotted shaft FMS; with a 1/2" split locking bushing. |
| 380C3 | 7/8" screwdriver slotted shaft FMS; 3/8" long bushing with 3/8 x 32-NEF-2A thread. |

Example: **380-C1-10K-S**

| | | | |
|------------|---|----------------------------|---|
| 380 | C1 | 10K | S |
| Series | Shaft & Bushing See Catalog Number and Description | Resistance Value (Ohms) | Taper See Chart B (Figure 2, page 45) |

Series 53 Standard Resistance Values

Series 53: Brass, nickel-plated shaft. Economical version of 380.

Series 53 Stock Values (Ohms)

53C1, 53C2, 53C3 Linear

| | | | | |
|------|------|------|---------|---------|
| 50 | 1500 | 20K | 250K | 3 Meg |
| 100 | 2000 | 25K | 350K | 3.5 Meg |
| 150 | 2500 | 35K | 500K | 4 Meg |
| 250 | 3500 | 50K | 750K | 5 Meg |
| 350 | 5000 | 75K | 1 Meg | 7.5 Meg |
| 500 | 7500 | 100K | 1.5 Meg | 10 Meg |
| 750 | 10K | 150K | 2.5 Meg | |
| 1000 | 15K | 200K | | |

| Dual Taper D53C1 | Z-Taper 53C1-Z | Reversed Z-Taper 53C1-RZ |
|---------------------|-------------------|-----------------------------|
|---------------------|-------------------|-----------------------------|

| | | | |
|-------|------|---------|------|
| 10K | 500 | 150K | 10K |
| 25K | 1K | 200K | 25K |
| 50K | 2.5K | 250K | 50K |
| 100K | 5K | 500K | 100K |
| 250K | 10K | 750K | 250K |
| 500K | 15K | 1 Meg | 500K |
| 1 Meg | 20K | 2 Meg | |
| | 25K | 2.5 Meg | |
| | 50K | 5 Meg | |
| | 100K | | |

Series 53 How to Order

| Catalog Number | Description |
|----------------|---|
| 53C1 | 2 in. (.50.5mm) round shaft FMS; 3/8 in. (9.52mm) long bushing with 3/8 in. (9.52mm) x 32-NEF-2A thread. |
| 53C2 | 5/8" screwdriver slotted shaft FMS; with a 1/2 in. (.50.5mm) split locking bushing. |
| 53C3 | 7/8 in (22.22mm) screwdriver slotted shaft FMS; 3/8 in. (9.52mm) long bushing with 38 in. (203.2mm) x 32-NEF 2A thread. |
| 53C1SW | Unsealed version of 53C1 available for use with field assembled switches. Order as 53C1 SW see table 1 for switch ordering. |
| 53C1-Z | Same as 53C1 but with Z taper (see chart B, page 45). |
| 53C1-RZ | Same as 53C1 but with Reversed Z taper (see chart B, page 45). |
| D53C1 | Dual ganged. Bushing and shaft same as 53C1. |

Table 1
Switches for 53C1 SW only. Must be ordered separately on a made-to-order basis.

| | |
|-------|---------------------------|
| 53-10 | SPST-3A-125 Vac |
| 53-20 | DPST-3A-125 Vac |
| 53-21 | (Mod.) DPST-3A-125 Vac/dc |

Series 53 How to Order, continued next page

Example: **53-C1-SW-1Meg-S**

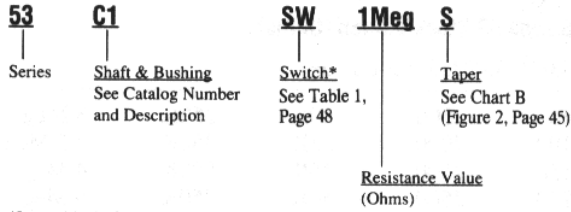

*Leave blank if switch is not required.

Series RV4 Standard Resistance Values

Series RV4: Military version of Series 53

RV4 Stock Values (Ohms, Tolerance and Tapers)

| RV4NAYSD | | | | RV4NAYSK | |
|----------|------|------|------|----------|-------|
| 500A | 252A | 753A | 205B | 101A* | 503A |
| 101A | 352A | 104A | 255B | 251A* | 104A* |
| 151A | 502A | 154A | 355B | 501A* | 254A |
| 251A | 752A | 204A | 505B | 102A | 504A |
| 351A | 103A | 254A | | 252A* | 105A* |
| 501A | 153A | 354A | | 502A | 255B |
| 751A | 203A | 504A | | 103A | 505B |
| 102A | 253A | 754A | | 253A | |
| 152A | 353A | 105A | | | |
| 202A | 503A | 155B | | | |

*Made-to-order; please consult Factory.

| RV4LAYSA | | | | RV4NAYSB | |
|----------|------|-------|------|----------|-------|
| 500A | 252A | 753A | 205B | 101A* | 503A |
| 101A | 352A | 104A | 255B | 251A | 104A |
| 151A | 502A | 154A | 355B | 501A | 254A |
| 251A | 752A | 204A | 505B | 102A | 504A |
| 351A | 103A | 254A | | 252A* | 105A |
| 501A | 153A | 354A | | 502A | 255B |
| 751A* | 203A | 504A | | 103A | 505B* |
| 102A | 253A | 754A | | 253A | |
| 152A | 353A | 105A | | | |
| 202A | 503A | 155B* | | | |

*Made-to-order; please consult Factory.

| RV4LAYSD | |
|----------|-------|
| 101A | 503A |
| 251A | 104A |
| 501A | 254A |
| 102A | 504A |
| 252A | 105A |
| 502A | 255B* |
| 103A | 505B |
| 253A | |

*Made-to-order; please consult Factory.

Series RV4 How To Order

Example: **RV4-N-A-Y-S-D-10-4-A**

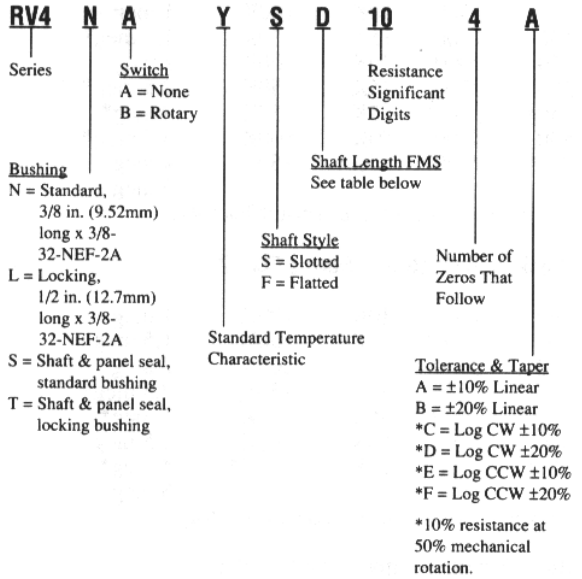

Shaft Length from Mounting Surface Table

| Shaft Length Code | With 3/8 in. (9.52mm) Lg Bushings N & S | With 1/2 in. (12.7mm) Lg Bushings L & T |
|-------------------|---|---|
| A | N/A | 5/8 in. (15.88 mm) |
| B | 1/2 in. (12.7 mm) | N/A |
| D | 7/8 in. (22.23 mm) | 7/8 in. (22.23 mm) |
| G | 1 1/4 in. (31.75 mm) | N/A |
| J | 2 in. (50.8 mm) | N/A |
| K | 2 1/2 in. (63.5 mm) | N/A |

N/A = Not available

Series 485 How To Order

Series 485 available on a made-to-order basis only. Please consult Factory for pricing, delivery, and minimums.