

On-Board Type (DC) EMI Suppression Filters (EMIFIL®)

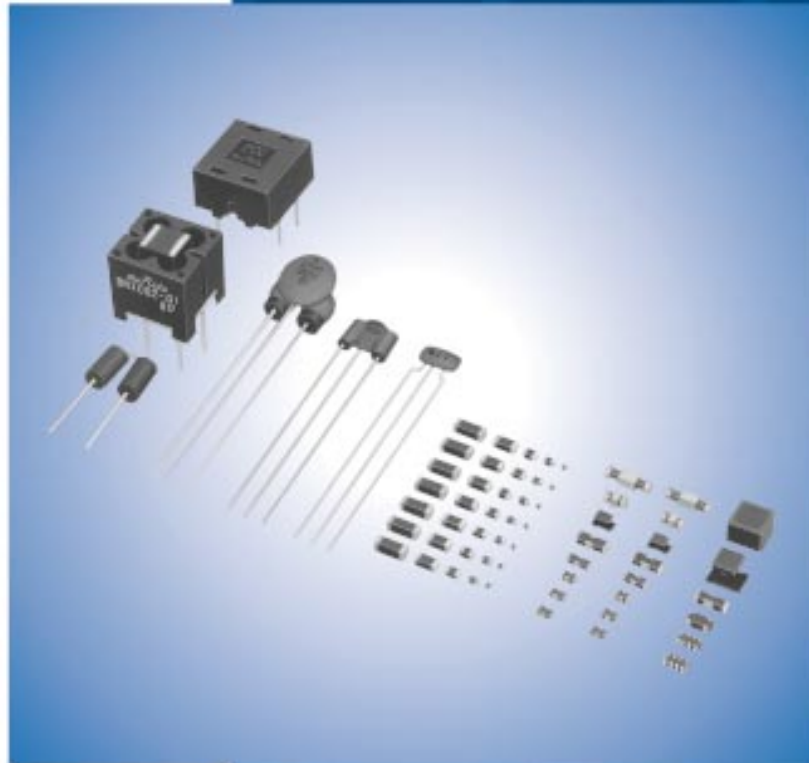

Cat.No.C31E-20

muRata *Innovator
in Electronics*
Murata
Manufacturing Co., Ltd.

for EU RoHS Compliant

- All the products in this catalog comply with EU RoHS.
- EU RoHS is "the European Directive 2002/95/EC on the Restriction of the Use of Certain Hazardous Substances in Electrical and Electronic Equipment".
- For more details, please refer to our website 'Murata's Approach for EU RoHS' (<http://www.murata.com/info/rohs.html>).

CONTENTS

EMIFIL®, EMIGUARD®, "EMIFIL" and "EMIGUARD" in this catalog are the trademarks of Murata Manufacturing Co., Ltd.

| | | |
|--|-----|---|
| Selection Guide of EMI Filters | 2 | |
| Product Guide / Effective Frequency Range | 4 | |
| Outlines of EMI Suppression Filters (EMIFIL®) for DC Line | 7 | |
| 1 Chip Ferrite Beads Part Numbering / Impedance Map / BLM Series Line Up | 13 | 1 |
| ●BLM02A/03A/15A/18A/21A | 21 | ●BLM18K |
| ●BLM18T | 32 | ●BLM18S |
| ●BLM03B/15B/18B/21B | 34 | ●For GHz Band Noise Suppression BLM15H/15E/18H/18E |
| ●BLM18R/21R | 50 | ●For High-GHz Band Noise Suppression BLM15G/18G |
| ●BLM03P/15P/18P/21P/31P/41P | 55 | ●Array Type BLA2AA/2AB/31A/31B |
| | | 85 |
| 2 Chip EMIFIL® Part Numbering | 92 | 2 |
| ●Capacitor Type NFM18C/21C/3DC/41C | 95 | ●RC Combined Type NFR21G |
| ●Capacitor Array Type NFA31C | 99 | ●RC Combined Array Type NFA31G |
| ●LC Combined Monolithic Type NFL18ST/18SP/21S | 100 | ●For Large Current NFM18P/21P/3DP/31P/41P/55P |
| ●LC Combined Array Type NFA18S/21S | 103 | ●LC Combined Type for Large Current NFE31P/61P |
| ●LC Combined Wire Wound Type NFW31S | 106 | 121 |
| 3 Chip Common Mode Choke Coils Part Numbering | 123 | 3 |
| ●Film Type DLP0NS/11S/31S | 124 | ●Wire Wound Type DLW21S/21H/31S |
| ●Film Type Array DLP2AD/31D | 128 | ●Wire Wound Type for Large Current DLW5AH/5BS/5BT |
| ●Monolithic Type DLM11G/2HG | 131 | 137 |
| 4 Block Type EMIFIL® | | 4 |
| ●SMD Type BNX022/023 | 140 | |
| ●Lead Type BNX00□/01□ | 141 | |
| 5 Lead Type EMI Suppression Filters (EMIFIL®) | | 5 |
| Ferrite Beads Inductors Part Numbering | | EMIGUARD® (EMIFIL® with Varistor Function) Part Numbering |
| ●BL01/02/03 | 145 | ●VFR3V/VFS6V/VFS9V |
| Disc Type EMIFIL® Part Numbering | | Common Mode Choke Coils Part Numbering |
| ●DS□6/Wide frequency DS□9N/Heavy-duty Type DS□9H | 149 | ●PLT09H |
| | | 167 |
| 6 Microwave Absorbers Part Numbering | 169 | 6 |
| ●EA10/20/21/22/30 | 170 | |
| △Caution / Notice | 173 | |
| Soldering and Mounting | 177 | |
| Packaging | 191 | |
| Chip EMI Suppression Filter Design Kits | 195 | |
| Outlines of Major Noise Regulation Standards | 203 | |
| Principles of Noise Suppression by DC EMIFIL® | 208 | |
| Murata EMI Filter Selection Simulator | 212 | |

Selection Guide of EMI Filters

Chip Ferrite Beads

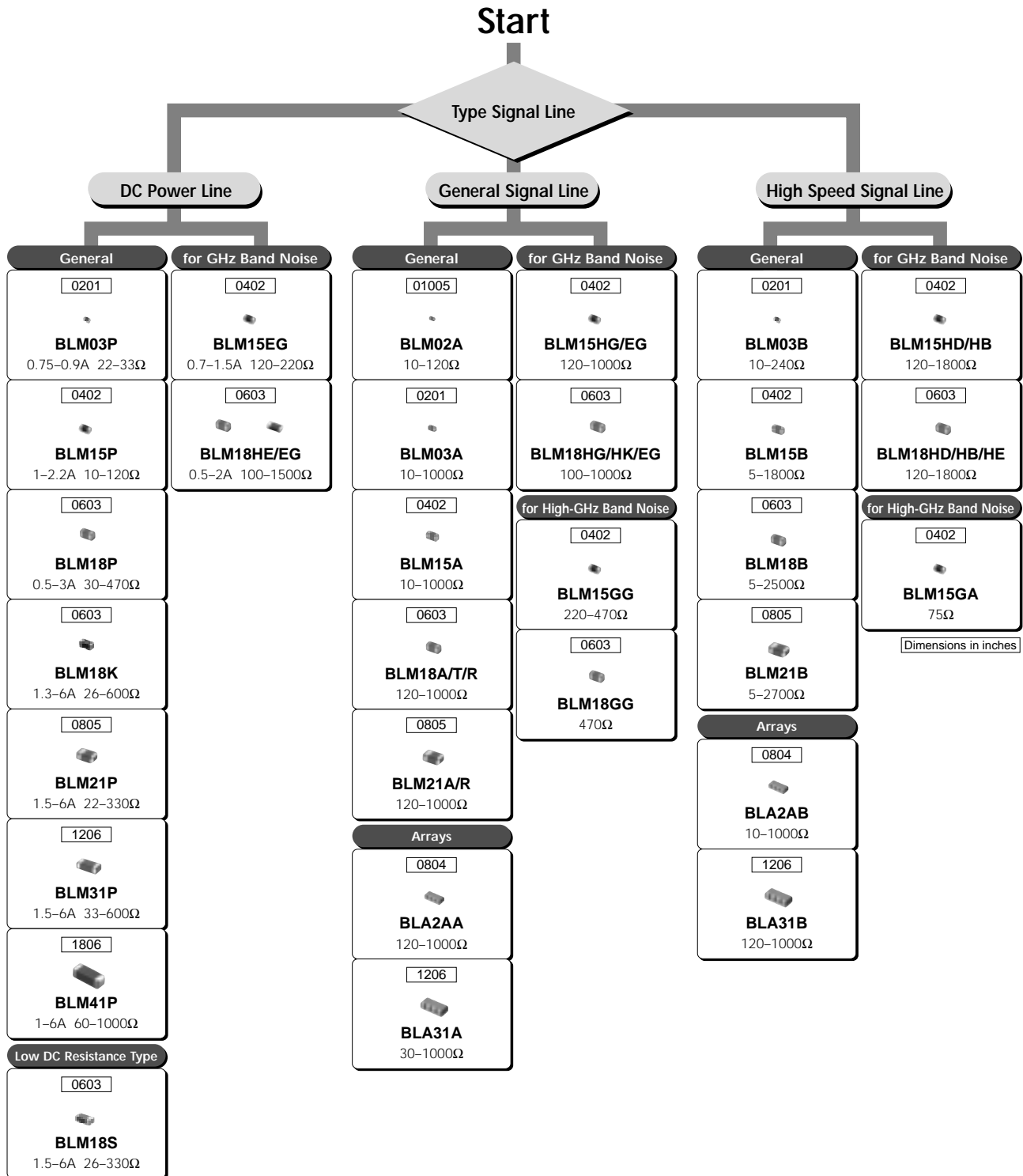

Impedance is typical value at 100MHz.

Selection Guide of EMI Filters

Chip EMIFIL®



Chip Common Mode Choke Coils

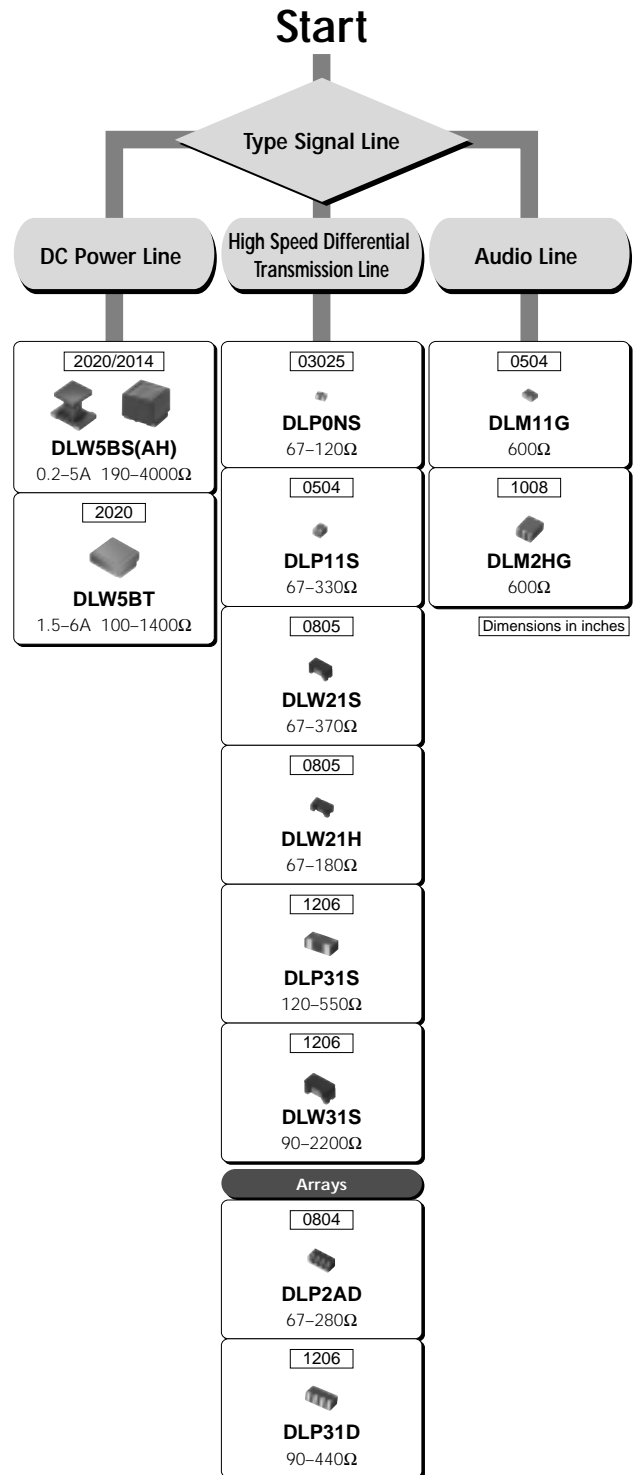

Impedance is typical value at 100MHz.

Product Guide/Effective Frequency Range

















Product Guide

| Inductor Type | Type | Series | Dimensions | | Effective Frequency Range | | | | | | | | | |
|------------------------------------|------------------------------|------------------------------|--------------|-------------|---------------------------|--------|------|-------|--------|------|-------|--|--|--|
| | | | (mm) | EIA Code | 10kHz | 100kHz | 1MHz | 10MHz | 100MHz | 1GHz | 10GHz | | | |
| | For Digital Interfaces | BLM18R | 1.6 ±0.8 | 0603 | | | | | | | | | | |
| | | BLM21R | 2.0 ±1.25 | 0805 | | | | | | | | | | |
| | Standard | BLM02A | 0.4 ±0.2 | 01005 | | | | | | | | | | |
| | | BLM03A | 0.6 ±0.3 | 0201 | | | | | | | | | | |
| | | BLM15A | 1.0 ±0.5 | 0402 | | | | | | | | | | |
| | | BLM18A | 1.6 ±0.8 | 0603 | | | | | | | | | | |
| | | BLM18T | 1.6 ±0.8 | 0603 | | | | | | | | | | |
| | | BLM21A | 2.0 ±1.25 | 0805 | | | | | | | | | | |
| | | BLA2AA (4 circuits array) | 2.0 ±1.0 | 0804 | | | | | | | | | | |
| | | BLA31A (4 circuits array) | 3.2 ±1.6 | 1206 | | | | | | | | | | |
| | | For High Speed Signals | BLM03B | 0.6 ±0.3 | 0201 | | | | | | | | | |
| | BLM15B | | 1.0 ±0.5 | 0402 | | | | | | | | | | |
| | BLM18B | | 1.6 ±0.8 | 0603 | | | | | | | | | | |
| | BLM21B | | 2.0 ±1.25 | 0805 | | | | | | | | | | |
| | BLA2AB (4 circuits array) | | 2.0 ±1.0 | 0804 | | | | | | | | | | |
| | BLA31B (4 circuits array) | | 3.2 ±1.6 | 1206 | | | | | | | | | | |
| | For High Current | BLM03P | 0.6 ±0.3 | 0201 | | | | | | | | | | |
| | | BLM15P | 1.0 ±0.5 | 0402 | | | | | | | | | | |
| | | BLM18P | 1.6 ±0.8 | 0603 | | | | | | | | | | |
| | | BLM18K | 1.6 ±0.8 | 0603 | | | | | | | | | | |
| BLM21P | | 2.0 ±1.25 | 0805 | | | | | | | | | | | |
| BLM31P | | 3.2 ±1.6 | 1206 | | | | | | | | | | | |
| BLM41P | | 4.5 ±1.6 | 1806 | | | | | | | | | | | |
| BLM18S (Low DC Resistance Type) | | 1.6 ±0.8 | 0603 | | | | | | | | | | | |

Continued on the following page. 

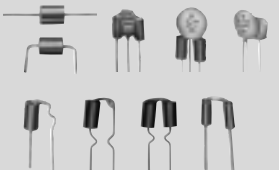

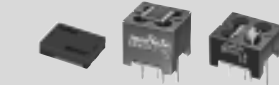







Product Guide/Effective Frequency Range

Continued from the preceding page.

| Type | Series | Dimensions | | Effective Frequency Range | | | | | | | |
|--|---|--------------------|-------------|---------------------------|--------|------|-------|--------|------|-------|--|
| | | (mm) | EIA Code | 10kHz | 100kHz | 1MHz | 10MHz | 100MHz | 1GHz | 10GHz | |
| Common Mode Choke Coils |  DLP0NS | 0.85 ■ ±0.65 | 03025 | | | | | | | | |
| |  DLP11S | 1.25 ■ ±1.0 | 0504 | | | | | | | | |
| |  DLP31S | 3.2 ■ ±1.6 | 1206 | | | | | | | | |
| |  DLP2AD | 2.0 ■ ±1.0 | 0804 | | | | | | | | |
| |  DLP31D | 3.2 ■ ±1.6 | 1206 | | | | | | | | |
| |  DLM11G | 1.25 ■ ±1.0 | 0504 | | | | | | | | |
| |  DLM2HG | 2.5 ■ ±2.0 | 1008 | | | | | | | | |
| |  DLW21S | 2.0 ■ ±1.2 | 0805 | | | | | | | | |
| |  DLW21H | 2.0 ■ ±1.2 | 0805 | | | | | | | | |
| |  DLW31S | 3.2 ■ ±1.6 | 1206 | | | | | | | | |
| |  DLW5BS (DLW5AH) | 5.0 ■ 5.0 (3.6) | 2020 (2014) | | | | | | | | |
| |  DLW5BT | 5.0 ■ 5.0 | 2020 | | | | | | | | |
| Disc EMIFIL® |  | | | | | | | | | | |
| EMIGUARD® (EMI Filters with varistor functions) |  | | | | | | | | | | |
| Block EMIFIL® |  | | | | | | | | | | |
| Common Mode Choke Coils |  | | | | | | | | | | |
| Microwave Absorbers |  | | | | | | | | | | |

Outline of EMI Suppression Filters (EMIFIL[®]) for DC Line

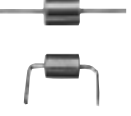
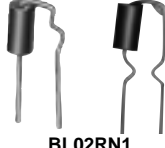
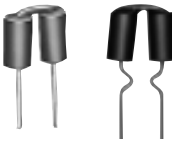
- Chip Ferrite Bead
- Ferrite Bead Inductor





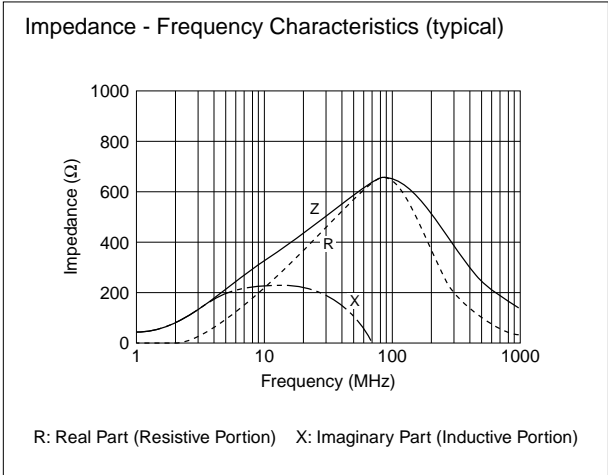
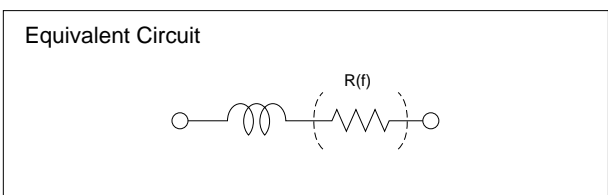





| | |
|--|--|
| <p>Chip Ferrite Beadp.21-91</p> <div style="display: flex; justify-content: space-around; align-items: center;"> <div style="text-align: center;">  BLM02 </div> <div style="text-align: center;">  BLM03 </div> <div style="text-align: center;">  BLM15 </div> <div style="text-align: center;">  BLM18 </div> <div style="text-align: center;">  BLA2A </div> </div> <div style="display: flex; justify-content: space-around; align-items: center; margin-top: 20px;"> <div style="text-align: center;">  BLM21 </div> <div style="text-align: center;">  BLM31 </div> <div style="text-align: center;">  BLM41 </div> <div style="text-align: center;">  BLA31 </div> </div> | <p>Ferrite Bead Inductorp.146-148</p> <div style="display: flex; justify-content: space-around; align-items: center;"> <div style="text-align: center;">  BL01 </div> <div style="text-align: center;">  BL02RN1 </div> </div> <div style="display: flex; justify-content: space-around; align-items: center; margin-top: 20px;"> <div style="text-align: center;">  BL02RN2 </div> <div style="text-align: center;">  BL03RN2 </div> </div> |
|--|--|

- Chip Ferrite Beads are effective for frequencies ranging from a few MHz to a few GHz. Chip Ferrite Beads are widely used as a low noise countermeasure, as well as a universal noise suppression component.
- Chip Ferrite Beads produce a micro inductance in the low frequency range. At high frequencies, however, the resistive component of the inductor produces the primary impedance. When inserted in series in the noise producing circuit, the resistive impedance of the inductor prevents noise propagation.



Outline of EMI Suppression Filters (EMIFIL®) for DC Line

- Chip EMIFIL®
- T-type Chip EMIFIL®
- Disk Type EMIFIL®

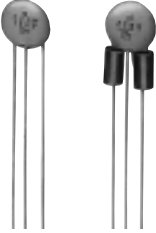
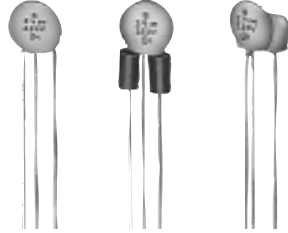



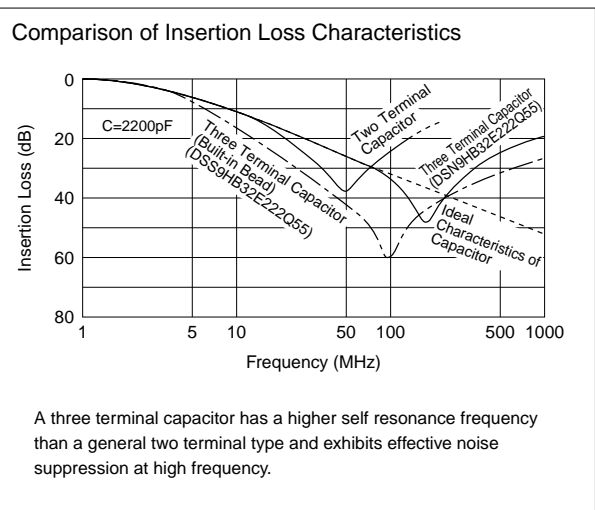





| | |
|--|---|
| <p>Chip EMIFIL®p.95-99 p.103-105 p.114-120</p> <div style="display: flex; justify-content: space-around; align-items: center;"> <div style="text-align: center;">  NFM18P </div> <div style="text-align: center;">  NFM21C </div> <div style="text-align: center;">  NFM21P </div> <div style="text-align: center;">  NFM31P </div> </div> <div style="display: flex; justify-content: space-around; align-items: center; margin-top: 10px;"> <div style="text-align: center;">  NFM3DC </div> <div style="text-align: center;">  NFA31C </div> <div style="text-align: center;">  NFA18S </div> <div style="text-align: center;">  NFA21S </div> </div> | <p>T-type Chip EMIFIL®p.121-122</p> <div style="display: flex; justify-content: space-around; align-items: center; margin-top: 20px;"> <div style="text-align: center;">  NFE31P </div> <div style="text-align: center;">  NFE61P/H </div> </div> |
| <p>Disk Type EMIFIL®p.150-158</p> <div style="display: flex; justify-content: space-around; align-items: center; margin-top: 20px;"> <div style="text-align: center;">  DS06 </div> <div style="text-align: center;">  DS09 </div> <div style="text-align: center;">  DS09H </div> </div> | |

- This capacitor type EMI suppression filter has a large noise suppression effect at frequencies ranging from a few MHz to hundreds of MHz. This type of filter is used widely as a universal, high performance EMI suppression component.
- The chip EMIFIL® incorporates a built-in three terminal capacitor, eliminating the lead wire and thereby increasing the high frequency performance characteristic.
- The T-type chip EMIFIL® is a chip EMI suppression filter with a built-in feed-thru capacitor. The use of ferrite beads on input and output terminals minimizes resonance with surrounding circuits.
- Whatever the situation, three terminal construction reduces residual inductance, thereby substantially improving noise suppression at frequencies over 10MHz.



Outline of EMI Suppression Filters (EMIFIL[®]) for DC Line

- Chip EMIFIL[®] for Signal Line
- Chip EMIFIL[®] with Waveform Distortion Suppressing Function

| | |
|--|---|
| <p>Chip EMIFIL[®] for Signal Linep.34–49 p.69–71 p.74–78 p.100–102 p.106–107</p> <div style="display: flex; justify-content: space-around; align-items: flex-start;"> <div style="text-align: center;">  NFW31S </div> <div style="text-align: center;">  NFL18ST </div> <div style="text-align: center;">  NFL18SP </div> <div style="text-align: center;">  NFL21S </div> </div> <div style="display: flex; justify-content: space-around; align-items: flex-start; margin-top: 10px;"> <div style="text-align: center;">  BLM03B </div> <div style="text-align: center;">  BLM15B/HB/HD </div> <div style="text-align: center;">  BLM18B/HB/HD/HE </div> <div style="text-align: center;">  BLM21B </div> </div> | <p>Chip EMIFIL[®] with Waveform Distortion Suppressing Functionp.108–113</p> <div style="display: flex; justify-content: space-around; align-items: center; margin-top: 20px;"> <div style="text-align: center;">  NFR21G </div> <div style="text-align: center;">  NFA31G </div> </div> |
|--|---|

- High-speed signal application EMIFIL[®] are high performance EMI suppression filters which increase the slope of insertion loss frequency characteristic curves (shape factor), thereby improving noise and signal separation. These are used for high speed signal applications in which noise and signal frequency approach the same value. To avoid the elimination of both the noise and specific signal components, three terminal capacitors and other components are applied. An NFW31S with a built-in capacitor and an inductor type BLM□□B are available. BLM□□HB/HD has additional performance for suppressing GHz range noise after cut-off frequency.
- The EMIFIL[®] with waveform distortion suppressing function suppresses waveform distortion caused by the resonance of digital ICs and surrounding circuits.

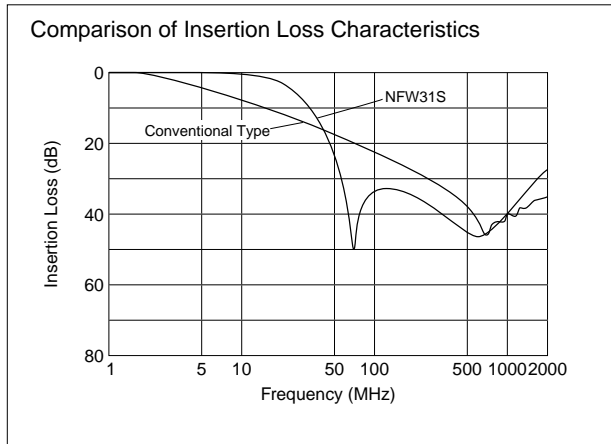

Outline of EMI Suppression Filters (EMIFIL®) for DC Line

- Chip Common Mode Choke Coil
- Common Mode Choke Coil

| | | | | | |
|--|--------|--------|--------|--------|-----------------------------------|
| Chip Common Mode Choke Coilp.124–139 | | | | | Common Mode Choke Coilp.168 |
| | | | | | |
| DLP0NS | DLP11S | DLP31S | DLP2AD | DLP31D | |
| | | | | | |
| DLM11G | DLM2HG | DLW21S | DLW21H | DLW31S | |
| | | | | | |
| DLW5AH | DLW5BS | DLW5BT | | | |

- These choke coils reduce common mode noise, which causes problems on balanced transmission lines, and are effective against common mode noise in the several MHz to several 100MHz frequency range. They are ideally suited for noise suppression on DC power supply lines and interface cables.

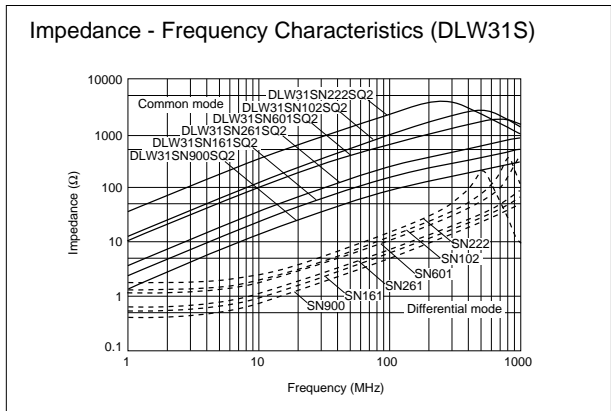
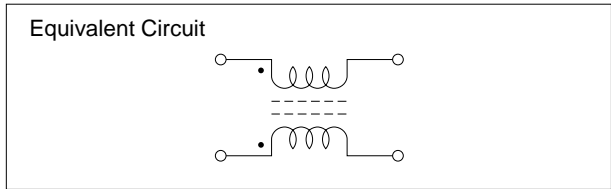
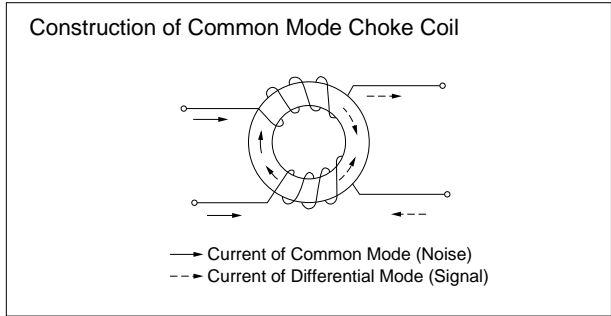

Outline of EMI Suppression Filters (EMIFIL[®]) for DC Line

● EMIGUARD[®]

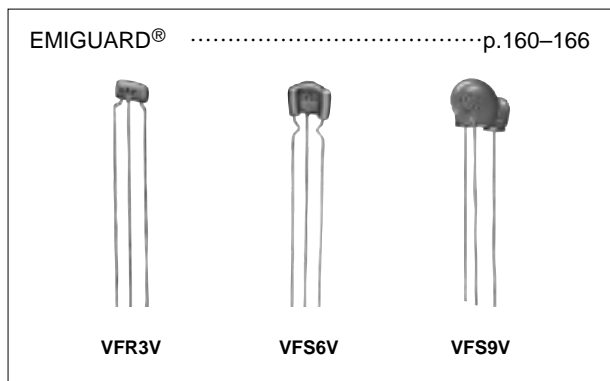

- EMIGUARD[®] eliminates both surge noises and EMI noises due to its dielectric varistor material.
- Effective when high frequency noise and high voltage surge suppression are required, and also in situations when surging starts at extremely high speeds. This type of surging cannot be eliminated with general type varistors.

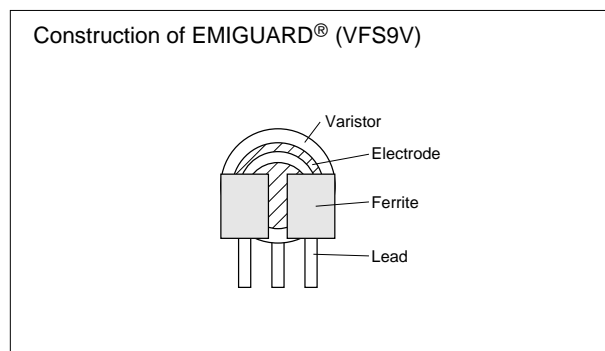

■ Surge Absorption Effect of EMIGUARD[®]

| Type of Filter | Surge Absorption Effect of EMIGUARD [®] |
|--|--|
| No filter | |
| Three terminal capacitor is used to suppress the surge. | |
| EMIGUARD [®] is used to suppress the surge. (VFS6V) | |

Outline of EMI Suppression Filters (EMIFIL®) for DC Line

●Block Type EMIFIL®

Block Type EMIFIL®p.140-144

BNX022/023 BNX002-01 BNX003-01 BNX005-01 BNX012-01 BNX016-01

- Block type EMIFIL® are resin encased, built-in, high performance EMI suppression filters, which use a feed-thru capacitor having excellent high frequency characteristics.
- Used when the noise frequency is high, or when extreme countermeasures are required.
- The high performance EMIFIL® BNX series exhibits significant noise suppression effects over a wide frequency band (extending from 100kHz to 1GHz) in DC power lines.

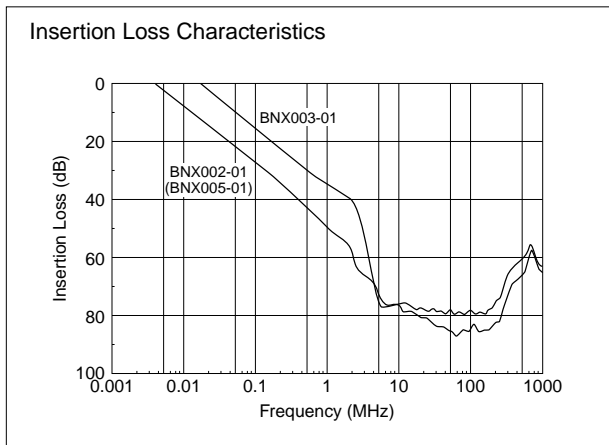
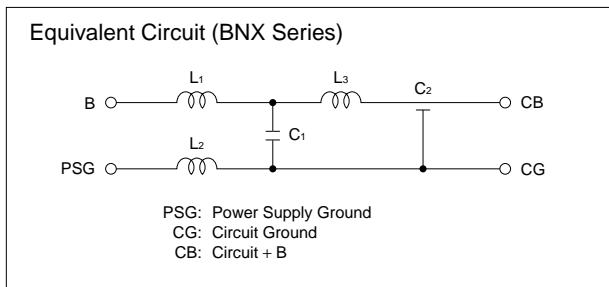

- In operating temperatures exceeding +85°C, derating of current is necessary for BNX010 series. Please apply the derating curve according to the operating temperature.

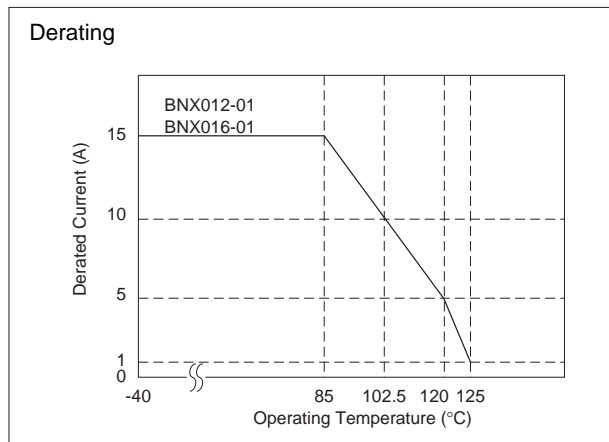

On-Board Type (DC) EMI Suppression Filters (EMIFIL®)



Chip Ferrite Beads Part Numbering

1

Chip Ferrite Beads

(Part Number)

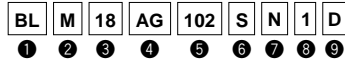

① Product ID

| Product ID | |
|------------|--------------------|
| BL | Chip Ferrite Beads |

② Type

| Code | Type |
|------|-----------------|
| A | Array Type |
| M | Monolithic Type |

③ Dimensions (L×W)

| Code | Dimensions (L×W) | EIA |
|------|------------------|-------|
| 02 | 0.4×0.2mm | 01005 |
| 03 | 0.6×0.3mm | 0201 |
| 15 | 1.0×0.5mm | 0402 |
| 18 | 1.6×0.8mm | 0603 |
| 2A | 2.0×1.0mm | 0804 |
| 21 | 2.0×1.25mm | 0805 |
| 31 | 3.2×1.6mm | 1206 |
| 41 | 4.5×1.6mm | 1806 |

④ Characteristics/Applications

| Code *1 | Characteristics/Applications | Series |
|---------|---|-----------------------------|
| AG | for General Use | BLM02/03/15/18/21, BLA2A/31 |
| TG | | BLM18 |
| BA | for High-speed Signal Lines | BLM15/18 |
| BB | | BLM03/15/18/21, BLA2A |
| BD | | BLM03/15/18/21, BLA2A/31 |
| PD | for Power Supplies | BLM15 |
| PG | | BLM03/15/18/21/31/41 |
| KG | | BLM18 |
| SG | for Power Supplies (Low DC Resistance Type) | BLM18 |
| RK | for Digital Interface | BLM18/21 |
| HG | for GHz Band General Use | BLM15/18 |
| EG | for GHz Band General Use (Low DC Resistance Type) | |
| HB | for GHz Band High-speed Signal Lines | BLM15/18 |
| HD | | |
| HE | | |
| HK | for GHz Band Digital Interface | BLM18 |
| GA | for High-GHz Band High-speed Signal Lines | BLM15 |
| GG | for High-GHz Band General Use | BLM15/18 |

*1 Frequency characteristics vary with each code.

⑤ Impedance

Expressed by three figures. The unit is in ohm (Ω) at 100MHz. The first and second figures are significant digits, and the third figure expresses the number of zeros which follow the two figures.

⑥ Electrode

Expressed by a letter.

Ex.)

| Code | Electrode |
|------|------------|
| S/T | Sn Plating |
| A | Au Plating |

⑦ Category

| Code | Category |
|------|---------------|
| N | Standard Type |

⑧ Number of Circuits

| Code | Number of Circuits |
|------|--------------------|
| 1 | 1 Circuit |
| 4 | 4 Circuits |

Continued on the following page.

 Continued from the preceding page.

 Packaging

| Code | Packaging | Series |
|----------|-------------------------------|--|
| K | Embossed Taping (ø330mm Reel) | BLM21 *1/31/41 |
| L | Embossed Taping (ø180mm Reel) | |
| B | Bulk | All Series |
| J | Paper Taping (ø330mm Reel) | BLM03/15/18 *3/21 *2, BLA2A/31 |
| D | Paper Taping (ø180mm Reel) | BLM02/03/15/18/21 *2, BLA2A/31 |
| C | Bulk Case | BLM15/18 |

*1 BLM21BD222SN1/BLM21BD272SN1 only.

*2 Except BLM21BD222SN1/BLM21BD272SN1

*3 Except BLM18T

1

On-Board Type (DC) EMI Suppression Filters (EMIFIL®)



Chip Ferrite Bead BLM Series

Covers Every Application in High Speed Signal Line, DC Power Lines and High-GHz Noise Suppression

1

The chip ferrite bead BLM series is comprised of ferrite beads in the shape of a chip. This ferrite bead generates a high impedance which at high frequencies mainly consists of a resistance element. BLM series is effective in circuits without stable ground lines because BLM series does not need a connection to ground.

Chip sizes of 0.4x0.2, 0.6x0.3, 1.0x0.5, 1.6x0.8, 2.0x1.25, 3.2x1.6 and 4.5x1.6mm are cataloged. (BLA series of array type chip ferrite beads is also cataloged.)

The nickel barrier structure of the external electrodes provides excellent solder heat resistance.

■Features

BLM series is comprised of R series (for digital interface), A/T series (for standard), B series (for high speed signal), P/S series (for large current), H/E series (for GHz band noise suppression), and G series (for High-GHz band noise suppression).

1. BLM□□R series – For Digital Interface
BLM-R series can be used in Digital Interface.
Resistance of BLM-R series especially grows in the lower frequency range. Therefore BLM-R series is less effective for digital signal waveform at low frequency range and can suppress the ringing.
2. BLM□□A/T series – For General Use
BLM-A series generates an impedance from the relatively low frequencies. Therefore BLM-A series is effective in noise suppression in the wide frequency range (30MHz – several hundred MHz).
3. BLM□□B series – For High Speed Signal
BLM-B series can minimize attenuation of the signal waveform due to its sharp impedance characteristics. Various impedances are available to match signal frequency.

4. BLM□□P/S series – For Large Current
BLM-P/S series can be used in high current circuits due to its low DC resistance. It can match power lines to a maximum of 6A DC.
5. BLM□□H/E series – For GHz Band Noise Suppression
BLM□□H/E series has horizontal wire wound structure that minimizes stray capacitance and increases the effective frequency range.
6. BLM□□G series – For High-GHz Band Noise Suppression
BLM□□G series has improved the performance in High-GHz frequency area using newly developed low dielectric ferrite material.

Impedance Characteristics

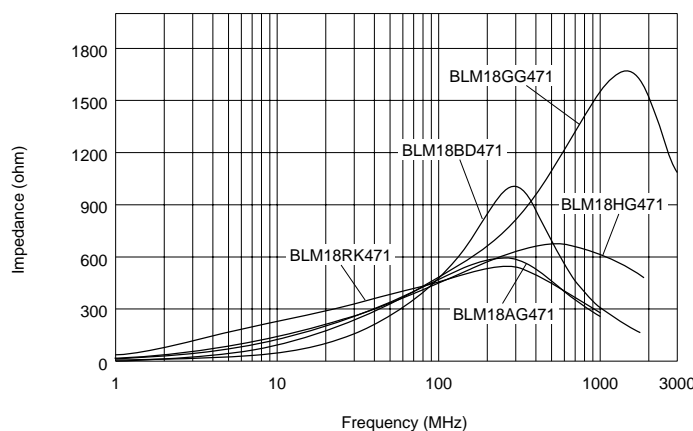

■ Impedance Map

1

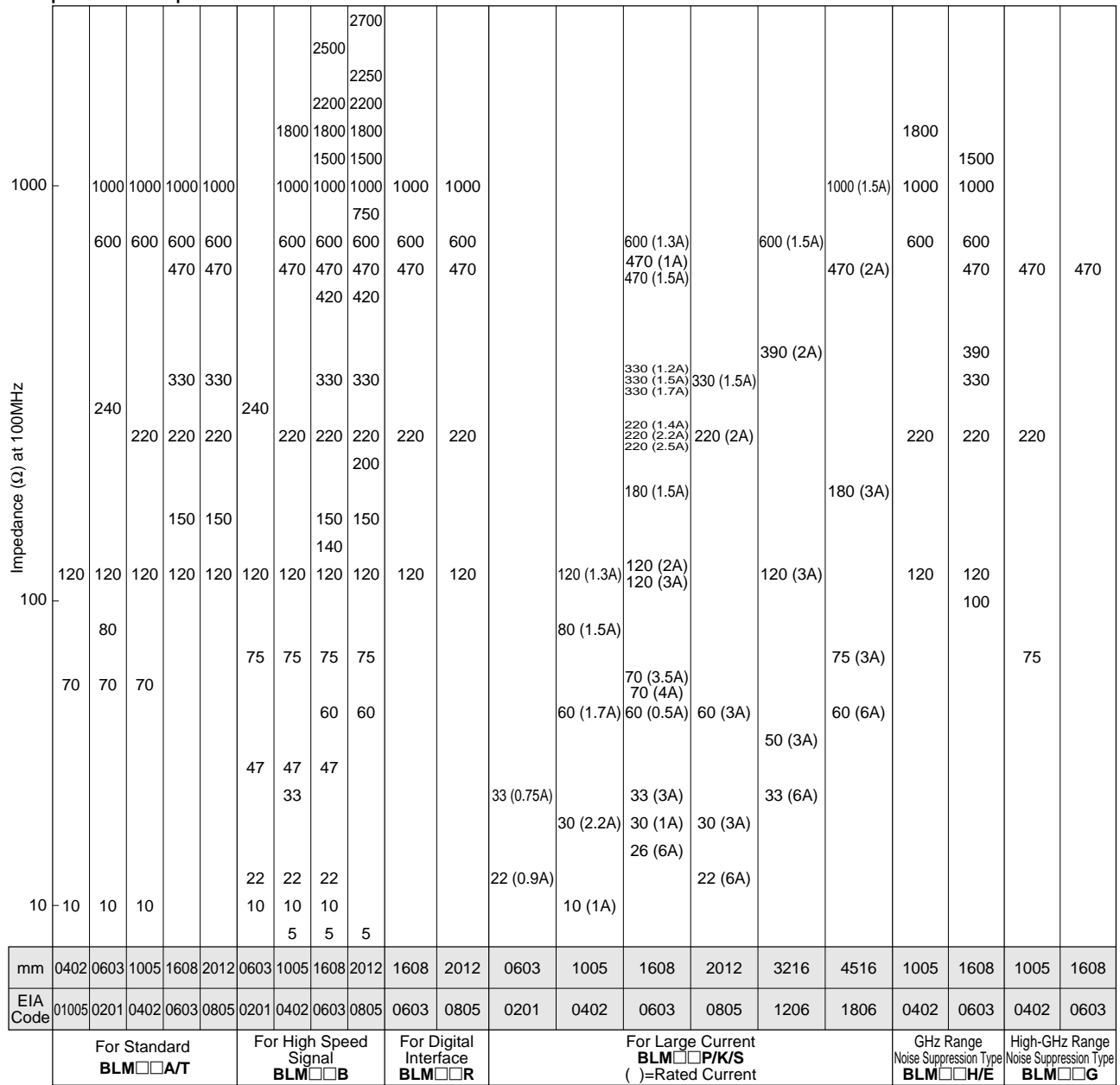

■ BLM Series

| Size (EIA Code) | Type | Part Number | Impedance (Ω) | | Rated Current (mA) |
|--|---------------------------------------|-------------------------------------|---------------|-----------|--------------------|
| | | | at 100MHz | at 1GHz | |
| 01005 | For Standard (p. 21 - 22) | BLM02AG100SN1 | 10 (Typ.) | - | 500 |
| | | BLM02AG700SN1 | 70±25% | - | 250 |
| | | BLM02AG121SN1 | 120±25% | - | 200 |
| 0201 | For Standard (p. 23 - 24) | BLM03AG100SN1 | 10 (Typ.) | - | 500 |
| | | BLM03AG700SN1 | 70 (Typ.) | - | 200 |
| | | BLM03AG800SN1 | 80±25% | - | 200 |
| | | BLM03AG121SN1 | 120±25% | - | 200 |
| | | BLM03AG241SN1 | 240±25% | - | 200 |
| | | BLM03AG601SN1 | 600±25% | - | 100 |
| | | BLM03AG102SN1 | 1000±25% | - | 100 |
| | For High Speed Signal (p. 34 - 35) | BLM03BB100SN1 | 10±25% | - | 300 |
| | | BLM03BB220SN1 | 22±25% | - | 200 |
| | | BLM03BB470SN1 | 47±25% | - | |
| | | BLM03BB750SN1 | 75±25% | - | |
| | | BLM03BB121SN1 | 120±25% | - | 100 |
| | | BLM03BD750SN1 | 75±25% | - | 300 |
| | | BLM03BD121SN1 | 120±25% | - | 250 |
| | | BLM03BD241SN1 | 240±25% | - | 200 |
| | For Large Current (p. 55 - 56) | BLM03PG220SN1 | 22±25% | - | 900 |
| | | BLM03PG330SN1 | 33±25% | - | 750 |
| | 0402 | For Standard (p. 25 - 26, p. 31) | BLM15AG100SN1 | 10 (Typ.) | - |
| BLM15AG700SN1 | | | 70 (Typ.) | - | 500 |
| BLM15AG121SN1 | | | 120±25% | - | |
| BLM15AG221SN1 | | | 220±25% | - | 300 |
| BLM15AG601SN1 | | | 600±25% | - | |
| BLM15AG102SN1 | | | 1000±25% | - | 200 |
| BLM15AG601AN1 | | | 600±25% | - | 300 |
| BLM15AG102AN1 | | 1000±25% | - | 200 | |
| For High Speed Signal (Sharp impedance characteristics) (p. 36 - 39) | | BLM15BA050SN1 | 5±25% | - | 300 |
| | | BLM15BB050SN1 | | - | 500 |
| | | BLM15BA100SN1 | 10±25% | - | 300 |
| | | BLM15BB100SN1 | | - | |
| | | BLM15BA220SN1 | 22±25% | - | |
| | | BLM15BB220SN1 | | - | |
| | | BLM15BA330SN1 | 33±25% | - | 200 |
| | | BLM15BA470SN1 | 47±25% | - | |
| | | BLM15BB470SN1 | 75±25% | - | 300 |
| | | BLM15BA750SN1 | | - | 200 |
| | | BLM15BB750SN1 | - | 300 | |
| | | BLM15BB121SN1 | 120±25% | | - |
| | | BLM15BB221SN1 | 220±25% | - | 200 |
| | | BLM15BD750SN1 | 75±25% | - | 300 |
| | | BLM15BD121SN1 | 120±25% | - | |
| | | BLM15BD221SN1 | 220±25% | - | |
| | | BLM15BD471SN1 | 470±25% | - | 200 |
| | | BLM15BD601SN1 | 600±25% | - | |
| BLM15BD102SN1 | | 1000±25% | - | 100 | |
| BLM15BD182SN1 | | 1800±25% | - | | |
| For Large Current (p. 56 - 57) | | BLM15PG100SN1 | 10 (Typ.) | - | 1000 |
| | | BLM15PD300SN1 | 30±25% | - | 2200* |
| | | BLM15PD600SN1 | 60±25% | - | 1700* |
| | | BLM15PD800SN1 | 80±25% | - | 1500* |
| | | BLM15PD121SN1 | 120±25% | - | 1300* |

* Please see p.57 "Derating of Rated Current".

Continued on the following page. 

1

Continued from the preceding page.

| Size (EIA Code) | Type | | Part Number | Impedance (Ω) | | Rated Current (mA) |
|-----------------|--|--|---------------------------------------|---------------|------------|--------------------|
| | | | | at 100MHz | at 1GHz | |
| 0402 | GHz Band | For Standard (p. 69 – 70) | BLM15HG601SN1 | 600±25% | 1000±40% | 300 |
| | | | BLM15HG102SN1 | 1000±25% | 1400±40% | 250 |
| | | For High Speed Signal (p. 69 – 71) | BLM15HB121SN1 | 120±25% | 500±40% | 300 |
| | | | BLM15HB221SN1 | 220±25% | 900±40% | 250 |
| | | | BLM15HD601SN1 | 600±25% | 1400±40% | 300 |
| | | | BLM15HD102SN1 | 1000±25% | 2000±40% | 250 |
| | For Standard (Low DC Resistance Type) (p. 72) | BLM15HD182SN1 | 1800±25% | 2700±40% | 200 | |
| | | BLM15EG121SN1 | 120±25% | 145 (Typ.) | 1500* | |
| | High-GHz Band | For Standard (Low DC Resistance Type) (p. 81 – 82) | BLM15EG221SN1 | 220±25% | 270 (Typ.) | 700* |
| | | | For High Speed Signal (p. 81 – 82) | BLM15GA750SN1 | 75±25% | 1000±40% |
| 0603 | For Standard (p. 27 – 28, p. 32 – 33) | BLM15GG221SN1 | 220±25% | 600±40% | 300 | |
| | | BLM15GG471SN1 | 470±25% | 1200±40% | 200 | |
| | | For High Speed Signal (Sharp impedance characteristics) (p. 40 – 45) | BLM18AG121SN1 | 120±25% | - | 500 |
| | | | BLM18AG151SN1 | 150±25% | - | |
| | | | BLM18AG221SN1 | 220±25% | - | |
| | | | BLM18AG331SN1 | 330±25% | - | |
| | | | BLM18AG471SN1 | 470±25% | - | |
| | | | BLM18AG601SN1 | 600±25% | - | 400 |
| | | | BLM18AG102SN1 | 1000±25% | - | |
| | | | BLM18TG121TN1 | 120±25% | - | 200 |
| | BLM18TG221TN1 | | 220±25% | - | | |
| | BLM18TG601TN1 | | 600±25% | - | | |
| | BLM18TG102TN1 | 1000±25% | - | 100 | | |
| | For High Speed Signal (Sharp impedance characteristics) (p. 40 – 45) | BLM18BA050SN1 | 5±25% | - | 500 | |
| | | BLM18BB050SN1 | | - | 700 | |
| | | BLM18BA100SN1 | 10±25% | - | 500 | |
| | | BLM18BB100SN1 | | - | 700 | |
| | | BLM18BA220SN1 | 22±25% | - | 500 | |
| | | BLM18BB220SN1 | | - | 600 | |
| | | BLM18BA470SN1 | 47±25% | - | 300 | |
| | | BLM18BB470SN1 | | - | 550 | |
| | | BLM18BD470SN1 | 60±25% | - | 500 | |
| | | BLM18BB600SN1 | | - | 550 | |
| | | BLM18BA750SN1 | 75±25% | - | 300 | |
| | | BLM18BB750SN1 | | - | 500 | |
| | | BLM18BA121SN1 | 120±25% | - | 200 | |
| | | BLM18BB121SN1 | | - | 500 | |
| | | BLM18BD121SN1 | 140±25% | - | 200 | |
| | | BLM18BB141SN1 | | - | 450 | |
| | | BLM18BB151SN1 | 150±25% | - | 450 | |
| | | BLM18BD151SN1 | | - | 200 | |
| | | BLM18BB221SN1 | 220±25% | - | 450 | |
| | | BLM18BD221SN1 | | - | 200 | |
| | BLM18BB331SN1 | 330±25% | - | 400 | | |
| | BLM18BD331SN1 | | - | 200 | | |
| | BLM18BD421SN1 | 420±25% | - | 200 | | |
| | BLM18BB471SN1 | | - | 300 | | |
| | BLM18BD471SN1 | 470±25% | - | 200 | | |
| | BLM18BD601SN1 | | - | 200 | | |
| | BLM18BD102SN1 | 600±25% | - | 200 | | |
| | BLM18BD152SN1 | | - | 100 | | |
| | BLM18BD182SN1 | 1800±25% | - | 50 | | |
| | BLM18BD222SN1 | | - | | | |
| | BLM18BD252SN1 | 2500±25% | - | | | |

* Please see p.73 "Derating of Rated Current".

Continued on the following page. ↗

Continued from the preceding page.

| Size (inches) | Type | | Part Number | Impedance (Ω) | | Rated Current (mA) | | |
|--|---------------------------------------|---------------|--|---------------|---------------------------------------|--------------------|---------------|---------|
| | | | | at 100MHz | at 1GHz | | | |
| 0603 | For Digital Interface (p. 50 – 51) | | BLM18RK121SN1 | 120±25% | - | 200 | | |
| | | | BLM18RK221SN1 | 220±25% | - | | | |
| | | | BLM18RK471SN1 | 470±25% | - | | | |
| | | | BLM18RK601SN1 | 600±25% | - | | | |
| | | | BLM18RK102SN1 | 1000±25% | - | | | |
| | For Large Current | | For Standard (p. 58 – 59 p. 64 – 66) | BLM18PG300SN1 | 30 (Typ.) | - | 1000 | |
| | | | | BLM18PG330SN1 | 33±25% | - | 3000* | |
| | | | | BLM18PG600SN1 | 60 (Typ.) | - | 500 | |
| | | | | BLM18PG121SN1 | 120±25% | - | 2000* | |
| | | | | BLM18PG181SN1 | 180±25% | - | 1500* | |
| | | | | BLM18PG221SN1 | 220±25% | - | 1400* | |
| | | | | BLM18PG331SN1 | 330±25% | - | 1200* | |
| | | | | BLM18PG471SN1 | 470±25% | - | 1000 | |
| | | | | BLM18KG260TN1 | 26±25% | - | 6000* | |
| | | | | BLM18KG700TN1 | 70±25% | - | 3500* | |
| | | | | BLM18KG121TN1 | 120±25% | - | 3000* | |
| | | | | BLM18KG221SN1 | 220±25% | - | 2200* | |
| | | | | BLM18KG331SN1 | 330±25% | - | 1700* | |
| | | | | BLM18KG471SN1 | 470±25% | - | 1500* | |
| | | | | BLM18KG601SN1 | 600±25% | - | 1300* | |
| | | | For Standard (Low DC Resistance Type) (p. 67 – 68) | | BLM18SG260TN1 | 26±25% | - | 6000* |
| | | | | | BLM18SG700TN1 | 70±25% | - | 4000* |
| | | | | | BLM18SG121TN1 | 120±25% | - | 3000* |
| | | | | | BLM18SG221TN1 | 220±25% | - | 2500* |
| | | | | | BLM18SG331TN1 | 330±25% | - | 1500* |
| | GHz Band | | For Standard (p. 74 – 76) | BLM18HG471SN1 | 470±25% | 600 (Typ.) | 200 | |
| | | | | BLM18HG601SN1 | 600±25% | 700 (Typ.) | | |
| | | | | BLM18HG102SN1 | 1000±25% | 1000 (Typ.) | | |
| | | | For High Speed Signal (p. 74 – 77) | | BLM18HB121SN1 | 120±25% | 500±40% | 200 |
| | | | | | BLM18HB221SN1 | 220±25% | 1100±40% | 100 |
| | | | | | BLM18HB331SN1 | 330±25% | 1600±40% | 50 |
| | | | | | BLM18HD471SN1 | 470±25% | 1000 (Typ.) | 100 |
| | | | | | BLM18HD601SN1 | 600±25% | 1200 (Typ.) | |
| | | | | | BLM18HD102SN1 | 1000±25% | 1700 (Typ.) | 50 |
| | | | | | BLM18HE601SN1 | 600±25% | 600 (Typ.) | 800* |
| | | | | | BLM18HE102SN1 | 1000±25% | 1000 (Typ.) | 600* |
| | | | | | BLM18HE152SN1 | 1500±25% | 1500 (Typ.) | 500* |
| | | | | | For Digital Interface (p. 74 – 77) | | BLM18HK331SN1 | 330±25% |
| | | | BLM18HK471SN1 | 470±25% | | | 600±40% | |
| | | | BLM18HK601SN1 | 600±25% | | | 700±40% | 100 |
| BLM18HK102SN1 | | | 1000±25% | 1200±40% | | | 50 | |
| For Standard (Low DC Resistance Type) (p. 78 – 79) | | | BLM18EG101TN1 | 100±25% | 140 (Typ.) | 2000* | | |
| | | | BLM18EG121SN1 | 120±25% | 145 (Typ.) | 2000* | | |
| | | | BLM18EG221TN1 | 220±25% | 300 (Typ.) | 1000 | | |
| | | | BLM18EG221SN1 | | 260 (Typ.) | 2000* | | |
| | | BLM18EG331TN1 | 330±25% | 450 (Typ.) | 500 | | | |
| | | BLM18EG391TN1 | 390±25% | 520 (Typ.) | 500 | | | |
| | | BLM18EG471SN1 | 470±25% | 550 (Typ.) | 500 | | | |
| | | BLM18EG601SN1 | 600±25% | 700 (Typ.) | 500 | | | |
| | | High-GHz Band | | (p. 83) | BLM18GG471SN1 | 470±25% | 1800±30% | 200 |

* Please see p.68, p.78, p.80 "Derating of Rated Current".

Continued on the following page. ↗

1

Continued from the preceding page.

| Size (inches) | Type | Part Number | Impedance (Ω) | | Rated Current (mA) |
|---------------|--|---------------|---------------|---------|--------------------|
| | | | at 100MHz | at 1GHz | |
| 0805 | For Standard (p. 29 - 30) | BLM21AG121SN1 | 120±25% | - | 200 |
| | | BLM21AG151SN1 | 150±25% | - | |
| | | BLM21AG221SN1 | 220±25% | - | |
| | | BLM21AG331SN1 | 330±25% | - | |
| | | BLM21AG471SN1 | 470±25% | - | |
| | | BLM21AG601SN1 | 600±25% | - | |
| | | BLM21AG102SN1 | 1000±25% | - | |
| | For High Speed Signal (Sharp impedance characteristics) (p. 46 - 49) | BLM21BB050SN1 | 5±25% | - | 200 |
| | | BLM21BB600SN1 | 60±25% | - | |
| | | BLM21BB750SN1 | 75±25% | - | |
| | | BLM21BB121SN1 | 120±25% | - | |
| | | BLM21BD121SN1 | | - | |
| | | BLM21BB151SN1 | 150±25% | - | |
| | | BLM21BD151SN1 | | - | |
| | | BLM21BB201SN1 | 200±25% | - | |
| | | BLM21BB221SN1 | 220±25% | - | |
| | | BLM21BD221SN1 | | - | |
| | | BLM21BB331SN1 | 330±25% | - | |
| | | BLM21BD331SN1 | | - | |
| | | BLM21BD421SN1 | 420±25% | - | |
| | | BLM21BB471SN1 | 470±25% | - | |
| | | BLM21BD471SN1 | | - | |
| | | BLM21BD601SN1 | 600±25% | - | |
| | | BLM21BD751SN1 | 750±25% | - | |
| | | BLM21BD102SN1 | 1000±25% | - | |
| | | BLM21BD152SN1 | 1500±25% | - | |
| | | BLM21BD182SN1 | 1800±25% | - | |
| | BLM21BD222SN1 | 2250 (Typ.) | - | | |
| | BLM21BD222TN1 | 2200±25% | - | | |
| | BLM21BD272SN1 | 2700±25% | - | | |
| | For Digital Interface (p. 52 - 53) | BLM21RK121SN1 | 120±25% | - | 200 |
| | | BLM21RK221SN1 | 220±25% | - | |
| | | BLM21RK471SN1 | 470±25% | - | |
| | | BLM21RK601SN1 | 600±25% | - | |
| | | BLM21RK102SN1 | 1000±25% | - | |
| | For Large Current (p. 60 - 61) | BLM21PG220SN1 | 22±25% | - | 6000* |
| | | BLM21PG300SN1 | 30 (Typ.) | - | 3000* |
| BLM21PG600SN1 | | 60±25% | - | 2000* | |
| BLM21PG221SN1 | | 220±25% | - | 1500* | |
| BLM21PG331SN1 | | 330±25% | - | 1500* | |
| 1206 | For Large Current (p. 61 - 62) | BLM31PG330SN1 | 33±25% | - | 6000* |
| | | BLM31PG500SN1 | 50 (Typ.) | - | 3000* |
| | | BLM31PG121SN1 | 120±25% | - | 2000* |
| | | BLM31PG391SN1 | 390±25% | - | 1500* |
| | | BLM31PG601SN1 | 600±25% | - | 1500* |
| 1806 | For Large Current (p. 63 - 64) | BLM41PG600SN1 | 60 (Typ.) | - | 6000* |
| | | BLM41PG750SN1 | 75 (Typ.) | - | 3000* |
| | | BLM41PG181SN1 | 180±25% | - | 3000* |
| | | BLM41PG471SN1 | 470±25% | - | 2000* |
| | | BLM41PG102SN1 | 1000±25% | - | 1500* |

* Please see p.68 "Derating of Rated Current".

1

On-Board Type (DC) EMI Suppression Filters (EMIFIL®)



Chip Ferrite Beads BLM02/03/15/18/21/31/41 Series

■ Features (BLM_A Series)

The chip ferrite beads BLM series is designed to function nearly as a resistor at noise frequencies, which greatly reduces the possibility of resonance and leaves signal wave forms undistorted.

BLM series is effective in circuits without stable ground lines because BLM series does not need a connection to ground.

The nickel barrier structure of the external electrodes provides excellent solder heat resistance. BLM_A series generates an impedance from the relatively low frequencies. Therefore BLM_A series is effective in noise suppression in a wide frequency range (30MHz to several hundred MHz).

The small size of BLM02A series (0.4x0.2mm) is suitable for noise suppression in small equipment such as PA modules for cellular phones.

■ Equivalent Circuit

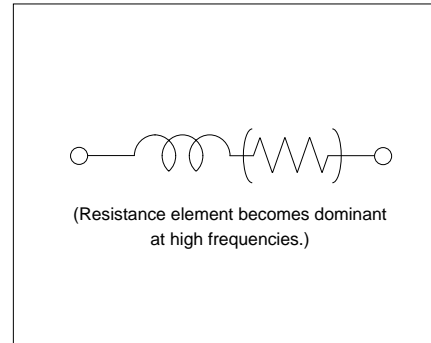

1

BLM02A Series (01005 Size)

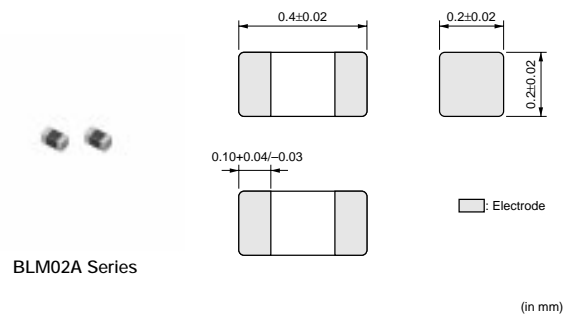

| Part Number | Impedance (at 100MHz/20°C) (ohm) | Rated Current (mA) | DC Resistance (max.) (ohm) | Operating Temperature Range (°C) |
|---------------|--|-----------------------|-------------------------------|--|
| BLM02AG100SN1 | 10 (Typ.) | 500 | 0.1 | -55 to +125 |
| BLM02AG700SN1 | 70 ±25% | 250 | 0.5 | -55 to +125 |
| BLM02AG121SN1 | 120 ±25% | 200 | 0.8 | -55 to +125 |

■ Impedance - Frequency (Typical)

BLM02A Series

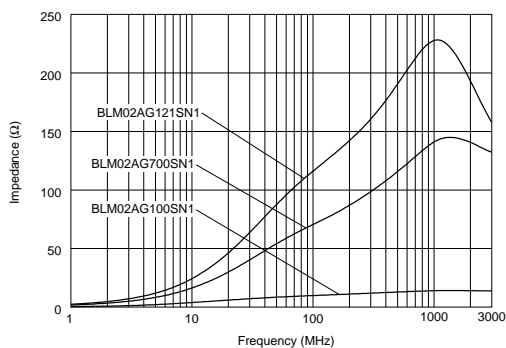

1

■ Impedance - Frequency Characteristics

BLM02AG100SN1

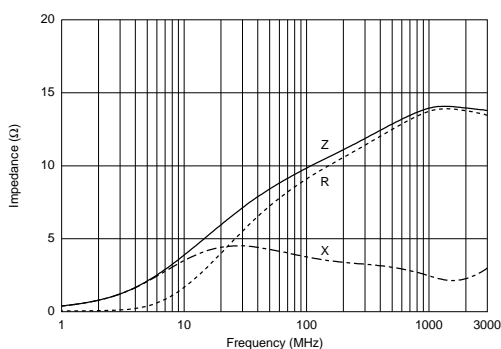

BLM02AG700SN1

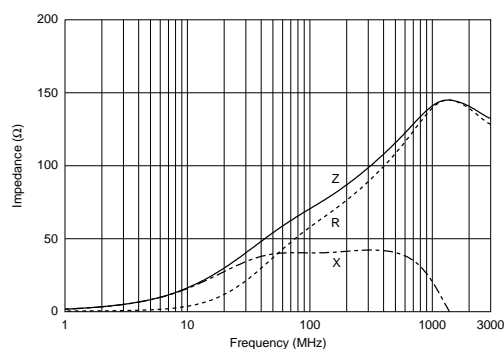

BLM02AG121SN1

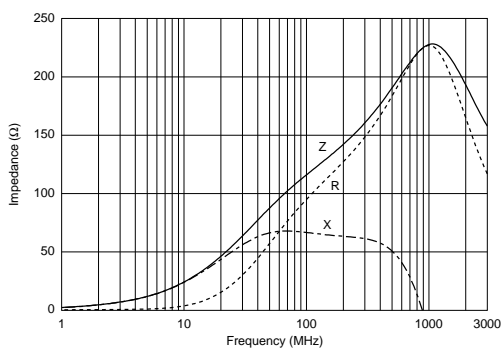

BLM03A Series (0201 Size)

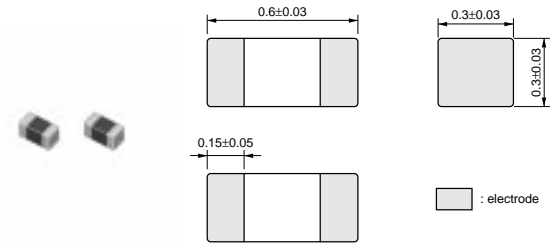

BLM03A Series

(in mm)

1

| Part Number | Impedance (at 100MHz/20°C) (ohm) | Rated Current (mA) | DC Resistance (max.) (ohm) | Operating Temperature Range (°C) |
|---------------|----------------------------------|--------------------|----------------------------|----------------------------------|
| BLM03AG100SN1 | 10 (Typ.) | 500 | 0.1 | -55 to +125 |
| BLM03AG700SN1 | 70 (Typ.) | 200 | 0.4 | -55 to +125 |
| BLM03AG800SN1 | 80 ±25% | 200 | 0.4 | -55 to +125 |
| BLM03AG121SN1 | 120 ±25% | 200 | 0.5 | -55 to +125 |
| BLM03AG241SN1 | 240 ±25% | 200 | 0.8 | -55 to +125 |
| BLM03AG601SN1 | 600 ±25% | 100 | 1.5 | -55 to +125 |
| BLM03AG102SN1 | 1000 ±25% | 100 | 2.5 | -55 to +125 |

■ Impedance - Frequency (Typical)

BLM03A Series

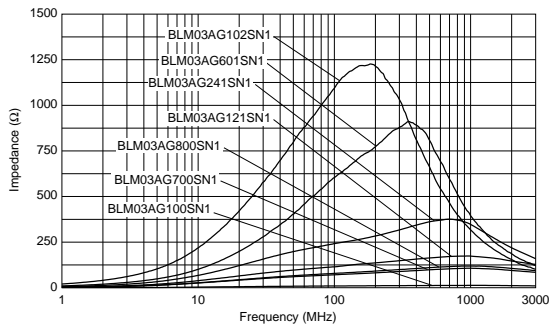

■ Impedance - Frequency Characteristics

BLM03AG100SN1

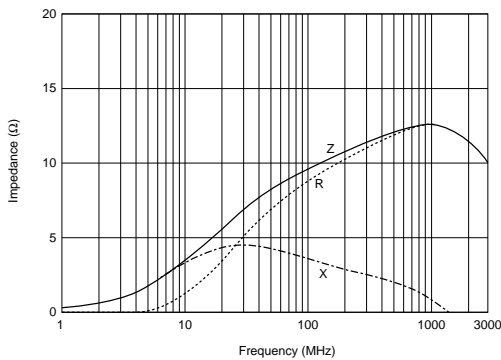

BLM03AG700SN1

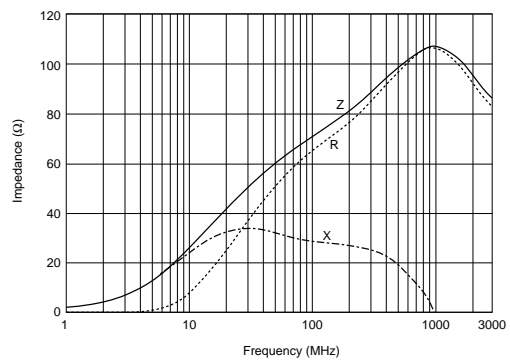

Continued on the following page. ↗

Continued from the preceding page.

Impedance - Frequency Characteristics

BLM03AG800SN1

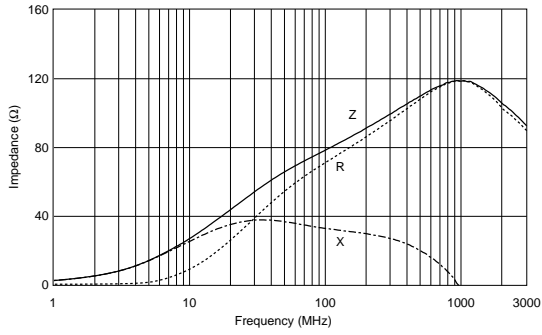

BLM03AG121SN1

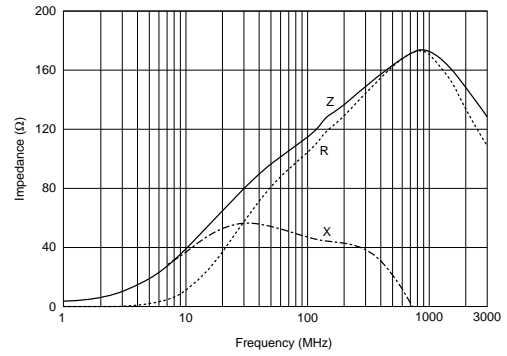

BLM03AG241SN1

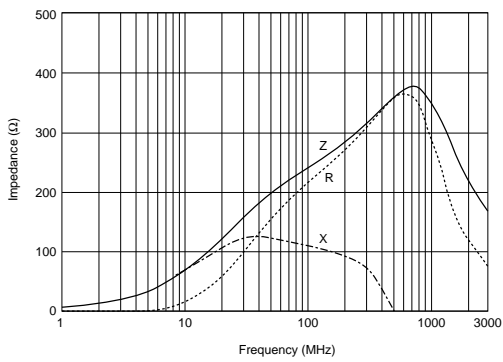

BLM03AG601SN1

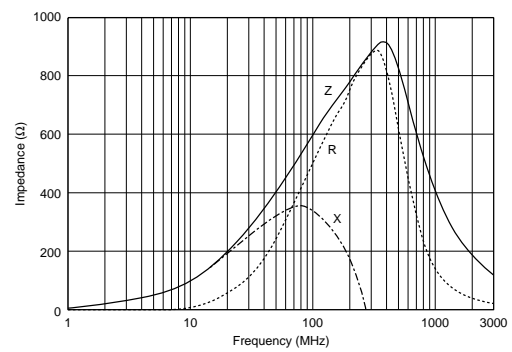

BLM03AG102SN1

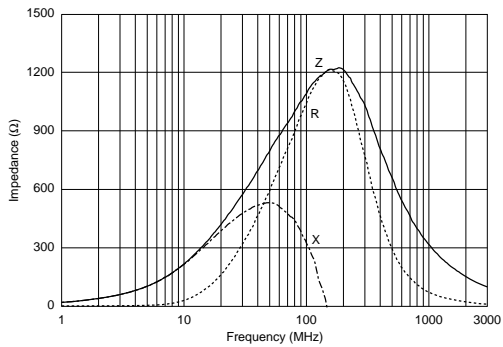

BLM15A Series (0402 Size)

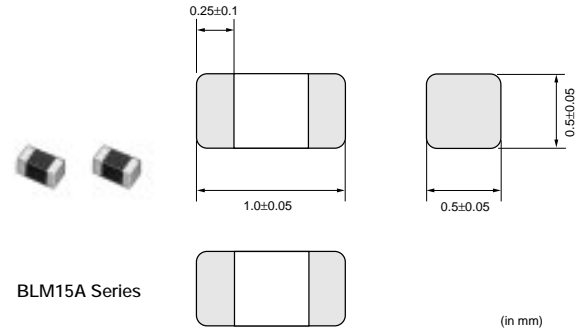

1

| Part Number | Impedance (at 100MHz/20°C) (ohm) | Rated Current (mA) | DC Resistance (max.) (ohm) | Operating Temperature Range (°C) |
|---------------|----------------------------------|--------------------|----------------------------|----------------------------------|
| BLM15AG100SN1 | 10 (Typ.) | 1000 | 0.05 | -55 to +125 |
| BLM15AG700SN1 | 70 (Typ.) | 500 | 0.15 | -55 to +125 |
| BLM15AG121SN1 | 120 ±25% | 500 | 0.25 | -55 to +125 |
| BLM15AG221SN1 | 220 ±25% | 300 | 0.35 | -55 to +125 |
| BLM15AG601SN1 | 600 ±25% | 300 | 0.6 | -55 to +125 |
| BLM15AG102SN1 | 1000 ±25% | 200 | 1.0 | -55 to +125 |

■ Impedance - Frequency (Typical)

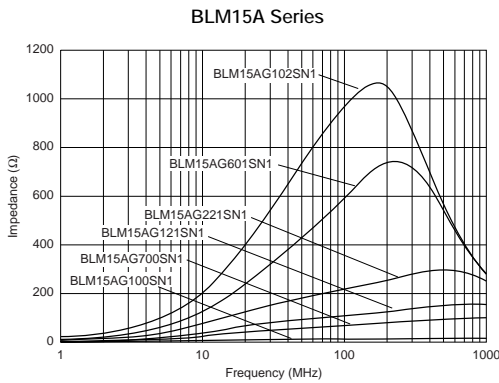

■ Impedance - Frequency Characteristics

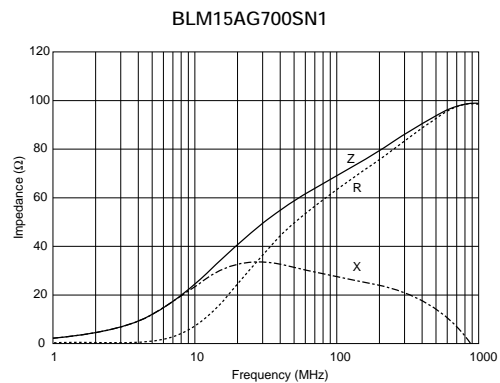
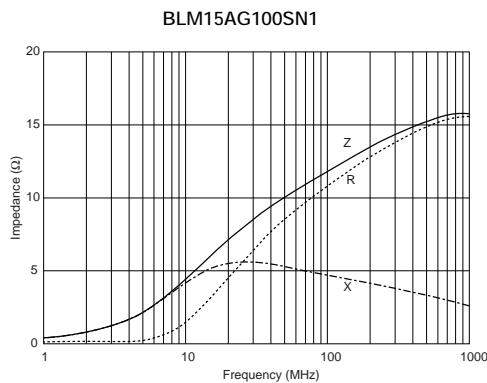

Continued on the following page. ↗

Continued from the preceding page.

■ Impedance - Frequency Characteristics

BLM15AG121SN1

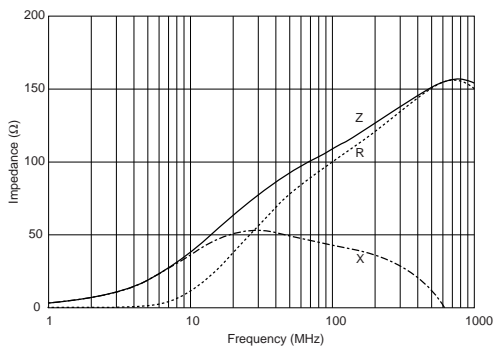

BLM15AG221SN1

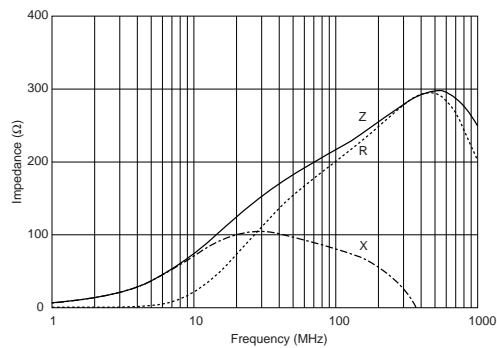

BLM15AG601SN1

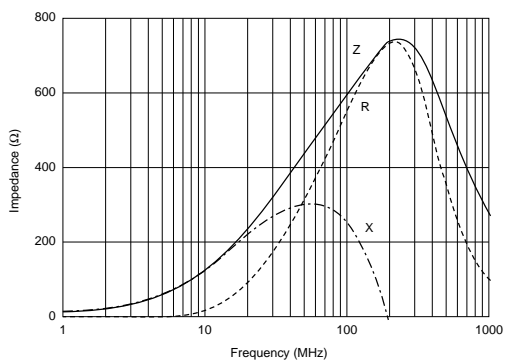

BLM15AG102SN1

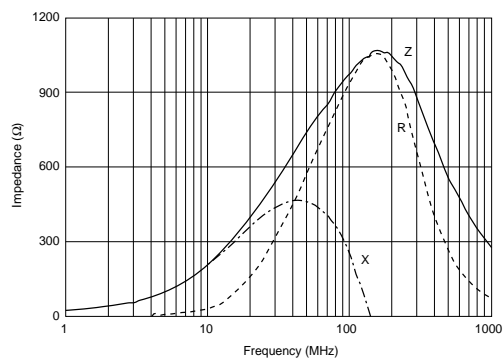

1

BLM18A Series (0603 Size)

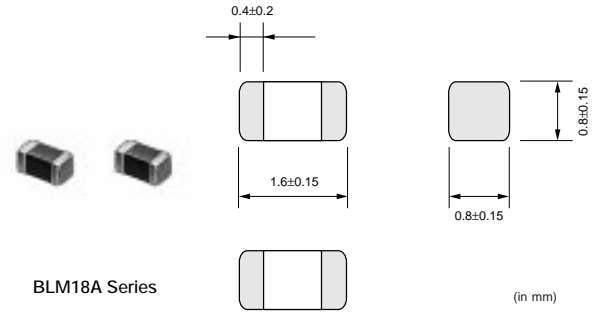

1

| Part Number | Impedance (at 100MHz/20°C) (ohm) | Rated Current (mA) | DC Resistance (max.) (ohm) | Operating Temperature Range (°C) |
|---------------|----------------------------------|--------------------|----------------------------|----------------------------------|
| BLM18AG121SN1 | 120 ±25% | 500 | 0.18 | -55 to +125 |
| BLM18AG151SN1 | 150 ±25% | 500 | 0.25 | -55 to +125 |
| BLM18AG221SN1 | 220 ±25% | 500 | 0.25 | -55 to +125 |
| BLM18AG331SN1 | 330 ±25% | 500 | 0.30 | -55 to +125 |
| BLM18AG471SN1 | 470 ±25% | 500 | 0.35 | -55 to +125 |
| BLM18AG601SN1 | 600 ±25% | 500 | 0.38 | -55 to +125 |
| BLM18AG102SN1 | 1000 ±25% | 400 | 0.50 | -55 to +125 |

■ Impedance - Frequency (Typical)

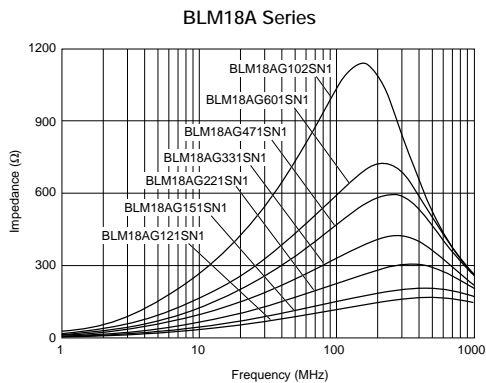

■ Impedance - Frequency Characteristics

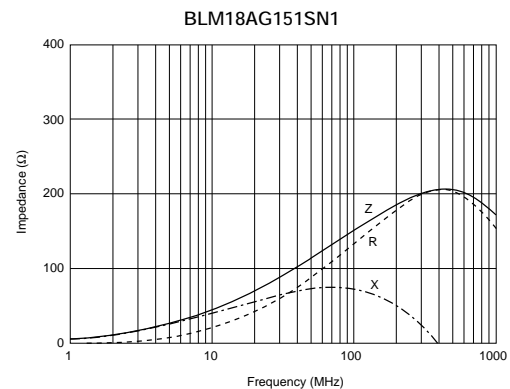
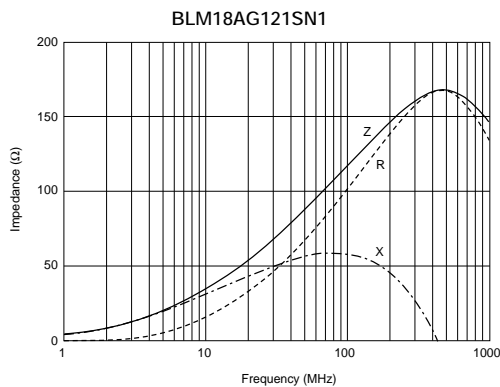

Continued on the following page. ↗

Continued from the preceding page.

Impedance - Frequency Characteristics

BLM18AG221SN1

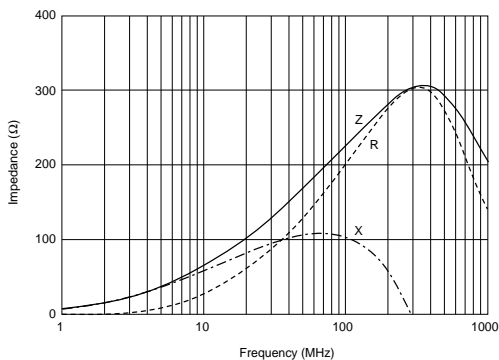

BLM18AG331SN1

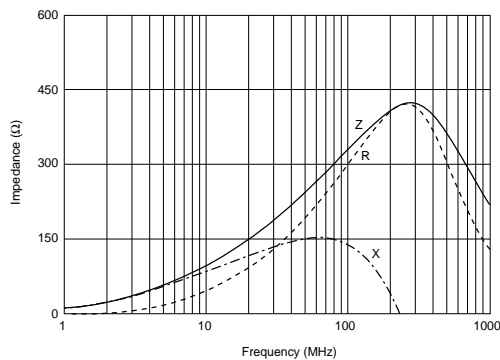

BLM18AG471SN1

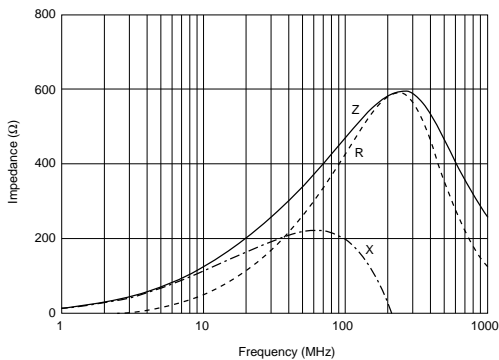

BLM18AG601SN1

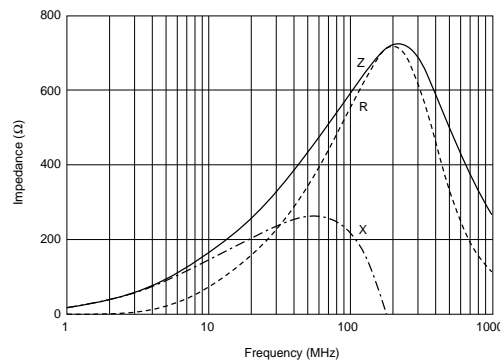

BLM18AG102SN1

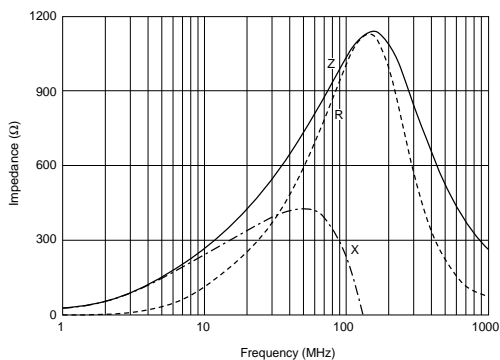

1

BLM21A Series (0805 Size)

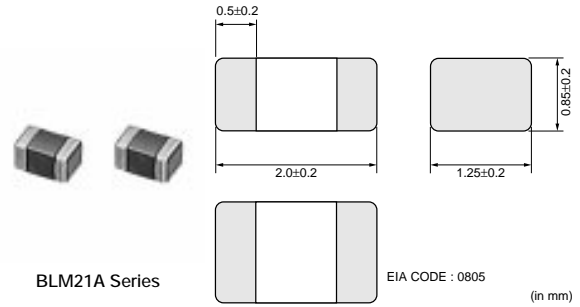

1

| Part Number | Impedance (at 100MHz/20°C) (ohm) | Rated Current (mA) | DC Resistance (max.) (ohm) | Operating Temperature Range (°C) |
|---------------|----------------------------------|--------------------|----------------------------|----------------------------------|
| BLM21AG121SN1 | 120 ±25% | 200 | 0.15 | -55 to +125 |
| BLM21AG151SN1 | 150 ±25% | 200 | 0.15 | -55 to +125 |
| BLM21AG221SN1 | 220 ±25% | 200 | 0.20 | -55 to +125 |
| BLM21AG331SN1 | 330 ±25% | 200 | 0.25 | -55 to +125 |
| BLM21AG471SN1 | 470 ±25% | 200 | 0.25 | -55 to +125 |
| BLM21AG601SN1 | 600 ±25% | 200 | 0.30 | -55 to +125 |
| BLM21AG102SN1 | 1000 ±25% | 200 | 0.45 | -55 to +125 |

■ Impedance - Frequency (Typical)

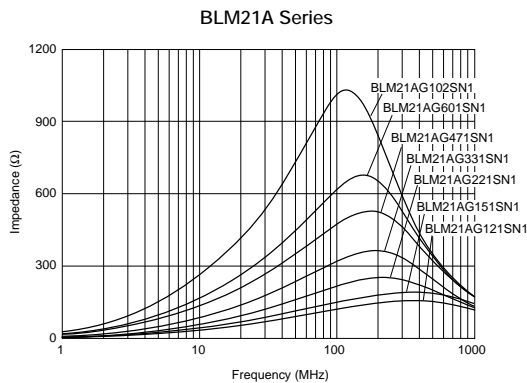

■ Impedance - Frequency Characteristics

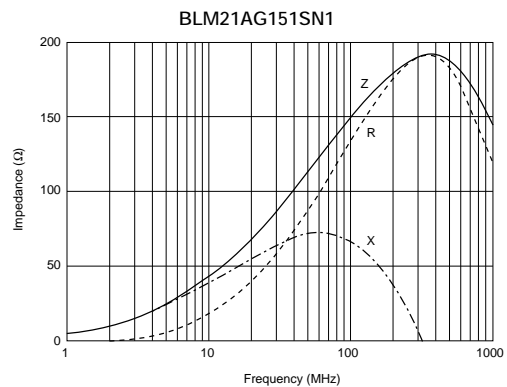
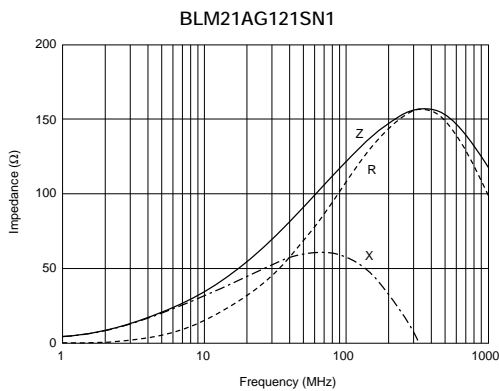

Continued on the following page. ↗

Continued from the preceding page.

Impedance - Frequency Characteristics

BLM21AG221SN1

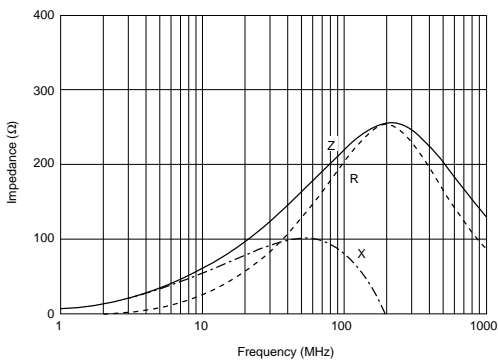

BLM21AG331SN1

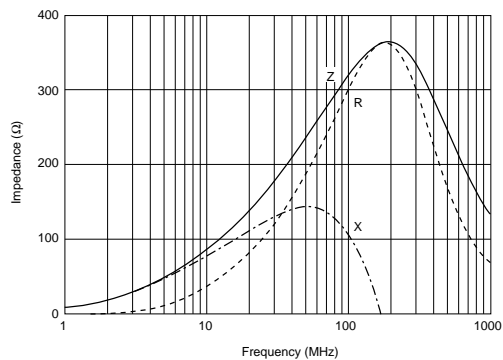

BLM21AG471SN1

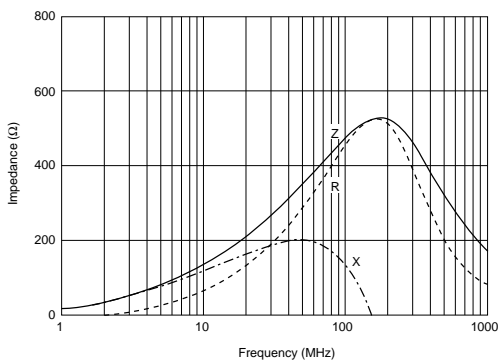

BLM21AG601SN1

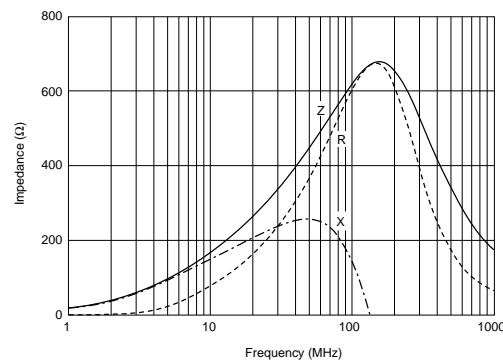

BLM21AG102SN1

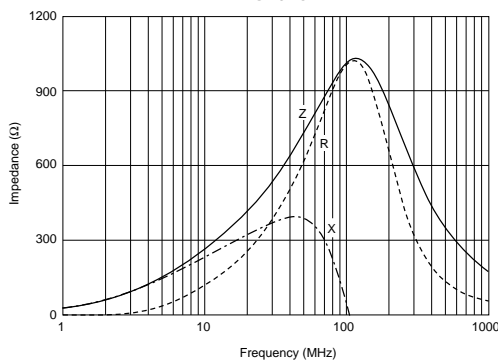

1

BLM15A Series Gold Plating (0402 Size)

■ Features

1. Au plating for wire bonding mounting
2. BLM_A series generates an impedance from the relatively low frequencies. Therefore BLM_A series is effective in noise suppression in a wide frequency range (30MHz to several hundred MHz).

■ Applications

1. Optical transceiver modules
2. Optical pickup modules

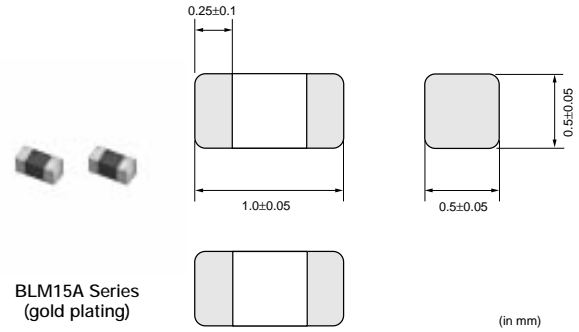

1

| Part Number | Impedance (at 100MHz/20°C) (ohm) | Rated Current (mA) | DC Resistance (max.) (ohm) | Operating Temperature Range (°C) |
|----------------------|----------------------------------|--------------------|----------------------------|----------------------------------|
| BLM15AG601AN1 | 600 ±25% | 300 | 0.6 | -55 to +125 |
| BLM15AG102AN1 | 1000 ±25% | 200 | 1.0 | -55 to +125 |

■ Impedance - Frequency (Typical)

BLM15A Series (gold plating)

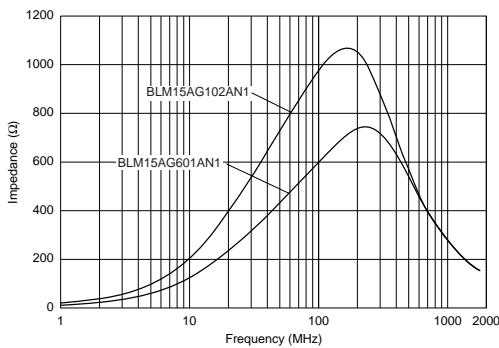

■ Impedance - Frequency Characteristics

BLM15AG601AN1

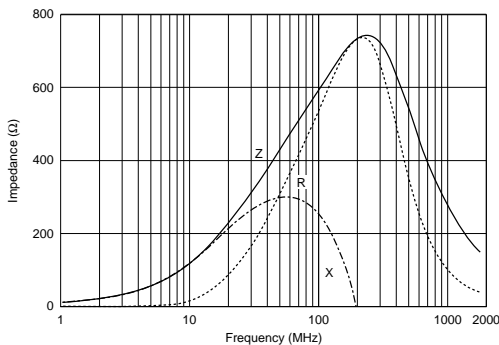

BLM15AG102AN1

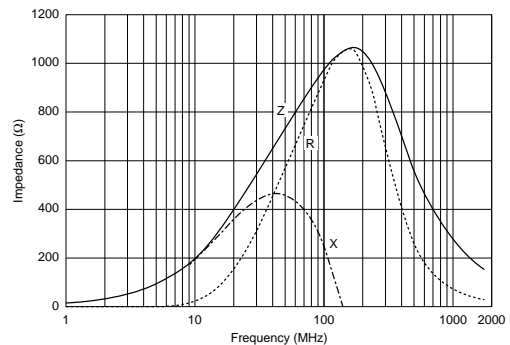

BLM18T Series (0603 Size)

■ Features

The chip ferrite beads BLM series is designed to function nearly as a resistor at noise frequencies, which greatly reduces the possibility of resonance and leaves signal wave forms undistorted.

BLM series is effective in circuits without stable ground lines because BLM series does not need a connection to ground.

The nickel barrier structure of the external electrodes provides excellent solder heat resistance.

BLM_T series generates an impedance from the relatively low frequencies. Therefore BLM_T series is effective in noise suppression in a wide frequency range (10MHz to several hundred MHz).

BLM_T series contributes further to miniaturizing portable equipment.

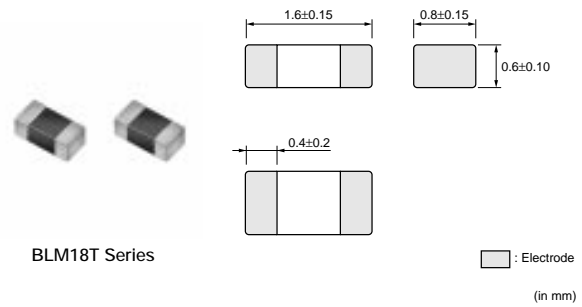

| Part Number | Impedance (at 100MHz/20°C) (ohm) | Rated Current (mA) | DC Resistance (max.) (ohm) | Operating Temperature Range (°C) |
|----------------------|----------------------------------|--------------------|----------------------------|----------------------------------|
| BLM18TG121TN1 | 120 ±25% | 200 | 0.25 | -55 to +125 |
| BLM18TG221TN1 | 220 ±25% | 200 | 0.30 | -55 to +125 |
| BLM18TG601TN1 | 600 ±25% | 200 | 0.45 | -55 to +125 |
| BLM18TG102TN1 | 1000 ±25% | 100 | 0.60 | -55 to +125 |

■ Impedance - Frequency (Typical)

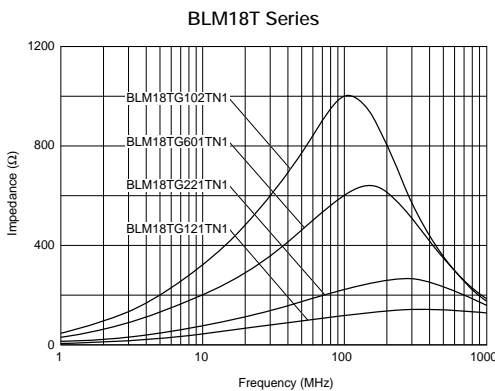

■ Impedance - Frequency Characteristics

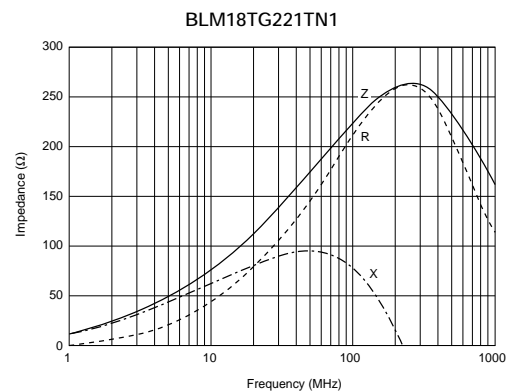
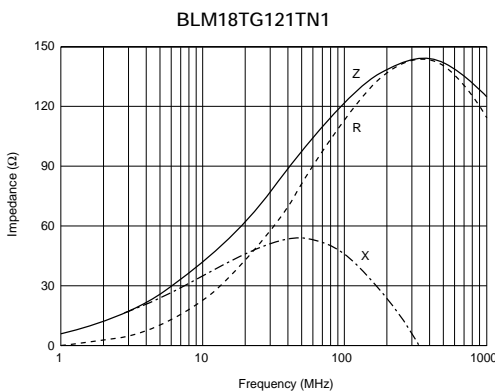

Continued on the following page. ↗

Continued from the preceding page.

■ Impedance - Frequency Characteristics

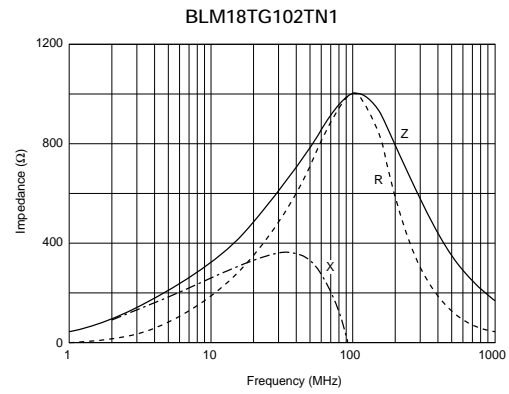
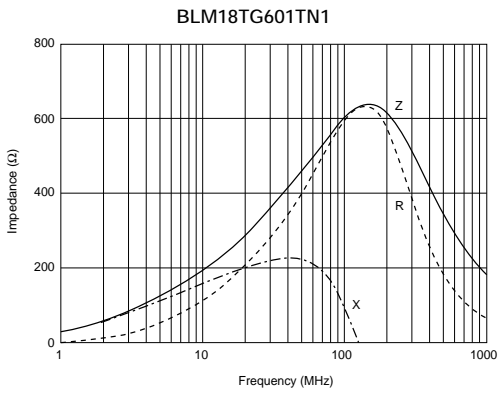

1

■ Features (BLM_B Series)

The chip ferrite beads BLM series is designed to function nearly as a resistor at noise frequencies, which greatly reduces the possibility of resonance and leaves signal wave forms undistorted.

BLM series is effective in circuits without stable ground lines because BLM series does not need a connection to ground.

The nickel barrier structure of the external electrodes provides excellent solder heat resistance. BLM_B series can minimize attenuation of the signal waveform due to its sharp impedance characteristics. Various impedances are available to match signal frequency.

The small size of BLM03B series (0.6x0.3mm) is suitable for advanced high-density mounting, and is followed on a miniaturization of digital equipment, or module of a functional portion.

■ Equivalent Circuit

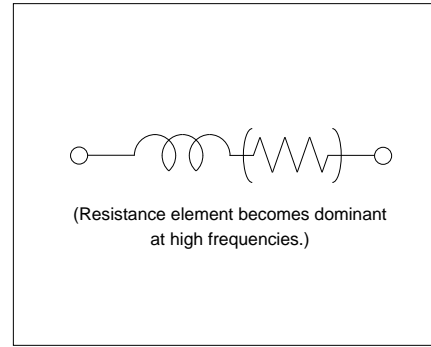

1

BLM03B Series (0201 Size)

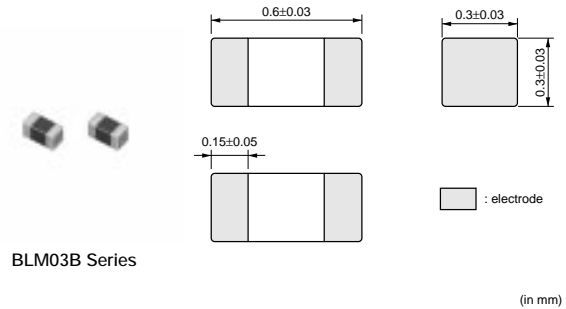

| Part Number | Impedance (at 100MHz/20°C) (ohm) | Rated Current (mA) | DC Resistance (max.) (ohm) | Operating Temperature Range (°C) |
|---------------|----------------------------------|--------------------|----------------------------|----------------------------------|
| BLM03BB100SN1 | 10 ±25% | 300 | 0.4 | -55 to +125 |
| BLM03BB220SN1 | 22 ±25% | 200 | 0.5 | -55 to +125 |
| BLM03BB470SN1 | 47 ±25% | 200 | 0.7 | -55 to +125 |
| BLM03BB750SN1 | 75 ±25% | 200 | 1.0 | -55 to +125 |
| BLM03BD750SN1 | 75 ±25% | 300 | 0.4 | -55 to +125 |
| BLM03BB121SN1 | 120 ±25% | 100 | 1.5 | -55 to +125 |
| BLM03BD121SN1 | 120 ±25% | 250 | 0.5 | -55 to +125 |
| BLM03BD241SN1 | 240 ±25% | 200 | 0.8 | -55 to +125 |

■ Impedance - Frequency (Typical)

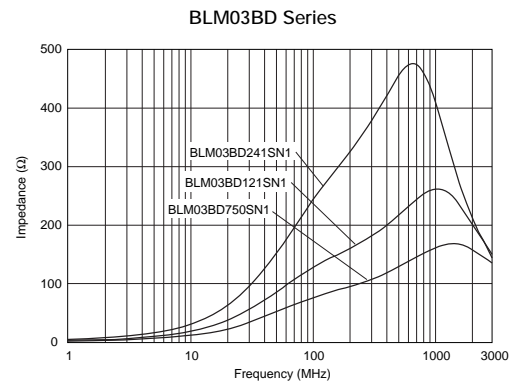
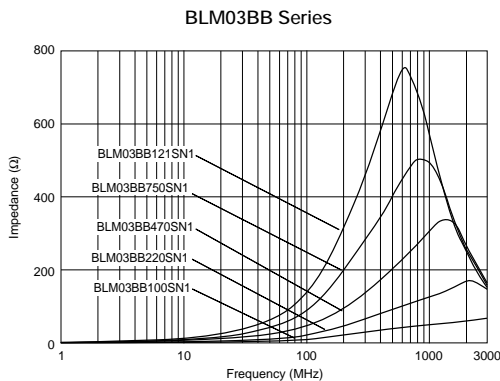

Continued on the following page. ↗

Continued from the preceding page.

Impedance - Frequency Characteristics

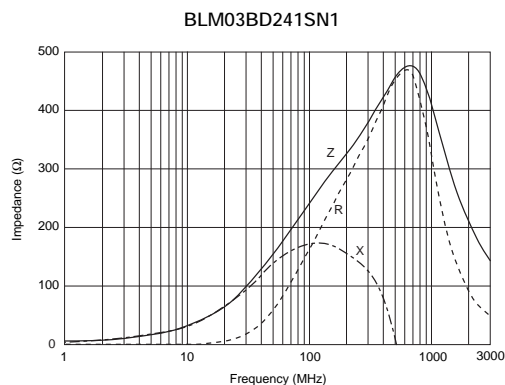
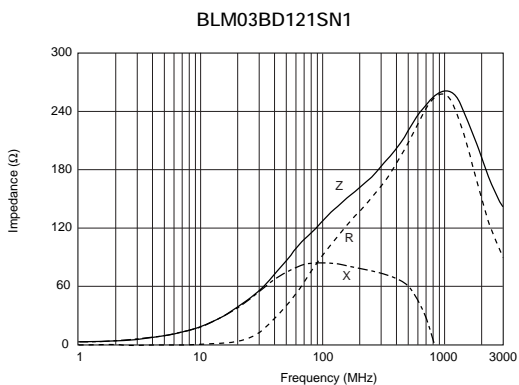
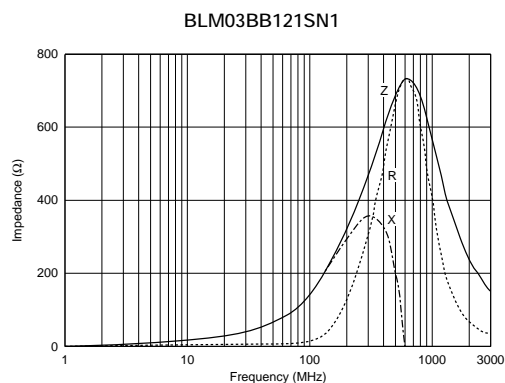
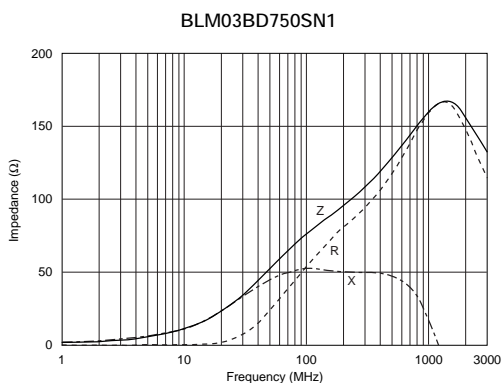
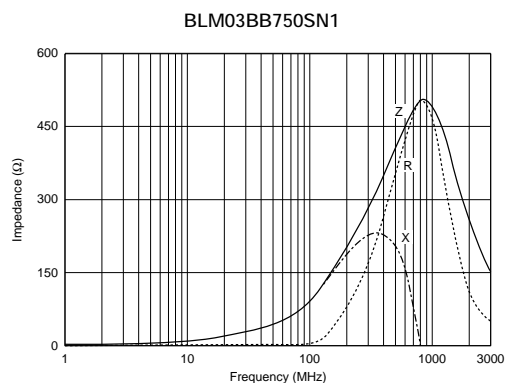
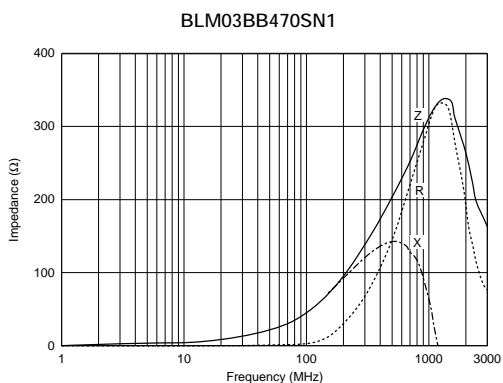
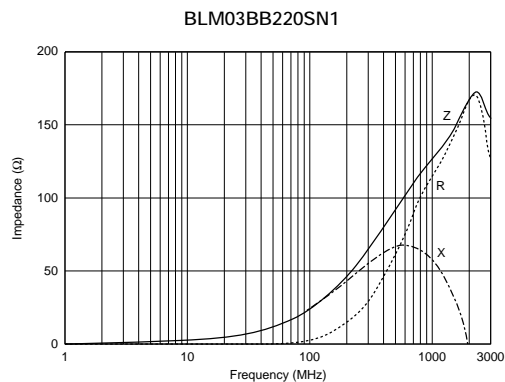
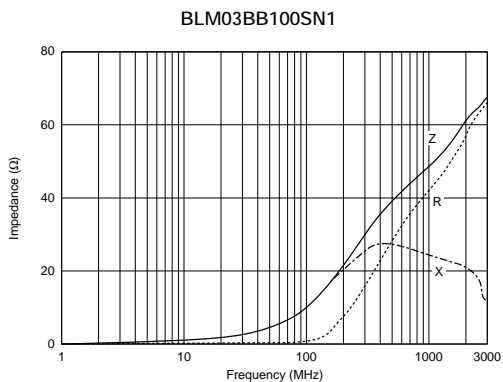

1

BLM15B Series (0402 Size)

1

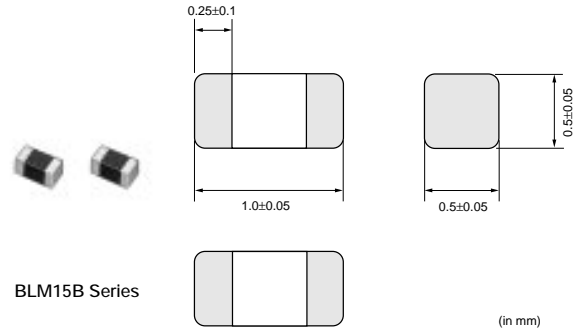

| Part Number | Impedance (at 100MHz/20°C) (ohm) | Rated Current (mA) | DC Resistance (max.) (ohm) | Operating Temperature Range (°C) |
|---------------|--|-----------------------|-------------------------------|--|
| BLM15BA050SN1 | 5 ±25% | 300 | 0.10 | -55 to +125 |
| BLM15BB050SN1 | 5 ±25% | 500 | 0.08 | -55 to +125 |
| BLM15BA100SN1 | 10 ±25% | 300 | 0.20 | -55 to +125 |
| BLM15BB100SN1 | 10 ±25% | 300 | 0.10 | -55 to +125 |
| BLM15BA220SN1 | 22 ±25% | 300 | 0.30 | -55 to +125 |
| BLM15BB220SN1 | 22 ±25% | 300 | 0.20 | -55 to +125 |
| BLM15BA330SN1 | 33 ±25% | 300 | 0.40 | -55 to +125 |
| BLM15BA470SN1 | 47 ±25% | 200 | 0.60 | -55 to +125 |
| BLM15BB470SN1 | 47 ±25% | 300 | 0.35 | -55 to +125 |
| BLM15BA750SN1 | 75 ±25% | 200 | 0.80 | -55 to +125 |
| BLM15BB750SN1 | 75 ±25% | 300 | 0.40 | -55 to +125 |
| BLM15BD750SN1 | 75 ±25% | 300 | 0.20 | -55 to +125 |
| BLM15BB121SN1 | 120 ±25% | 300 | 0.55 | -55 to +125 |
| BLM15BD121SN1 | 120 ±25% | 300 | 0.30 | -55 to +125 |
| BLM15BB221SN1 | 220 ±25% | 200 | 0.80 | -55 to +125 |
| BLM15BD221SN1 | 220 ±25% | 300 | 0.40 | -55 to +125 |
| BLM15BD471SN1 | 470 ±25% | 200 | 0.60 | -55 to +125 |
| BLM15BD601SN1 | 600 ±25% | 200 | 0.65 | -55 to +125 |
| BLM15BD102SN1 | 1000 ±25% | 200 | 0.90 | -55 to +125 |
| BLM15BD182SN1 | 1800 ±25% | 100 | 1.40 | -55 to +125 |

■ Impedance - Frequency (Typical)

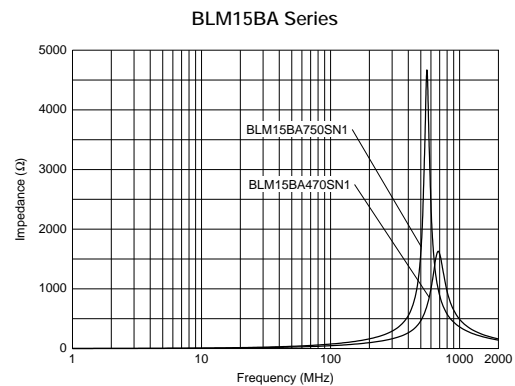
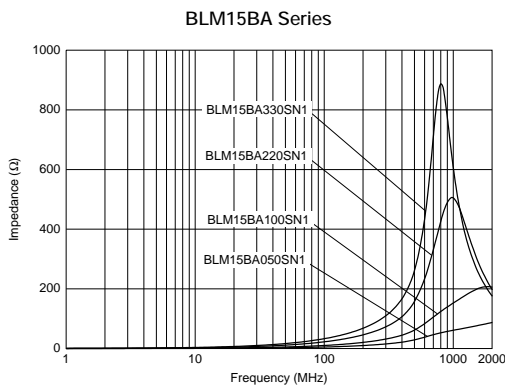

Continued on the following page. ↗

Continued from the preceding page.

Impedance - Frequency (Typical)

BLM15BB Series

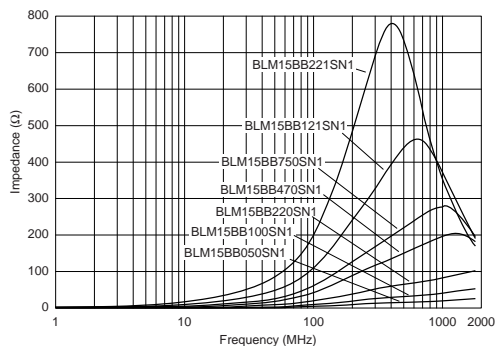

BLM15BD Series

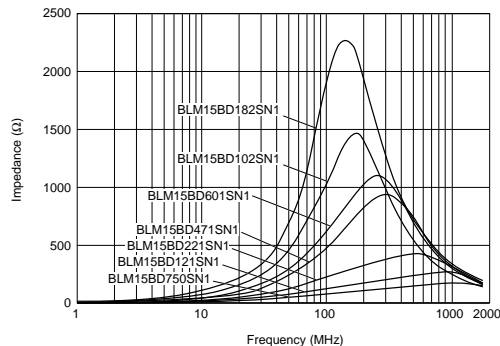

1

Impedance - Frequency Characteristics

BLM15BA050SN1

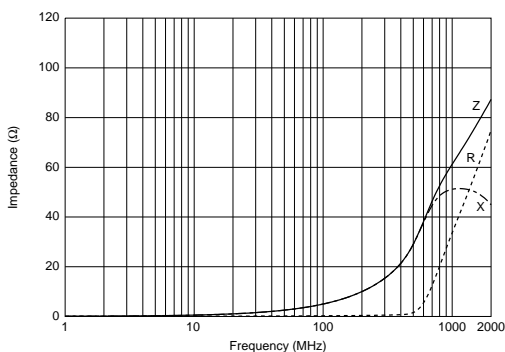

BLM15BB050SN1

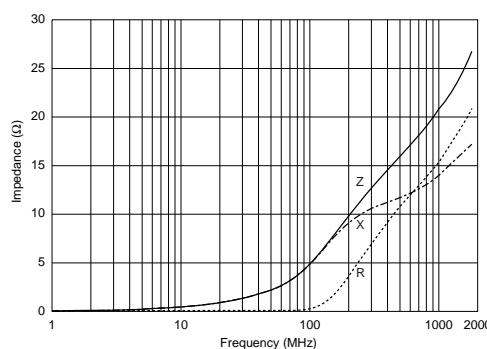

BLM15BA100SN1

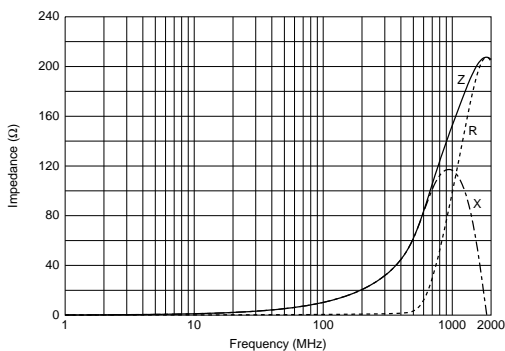

BLM15BB100SN1

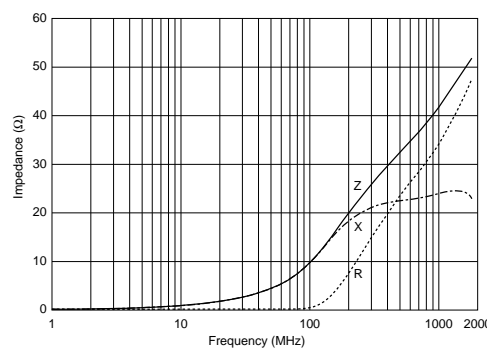

BLM15BA220SN1

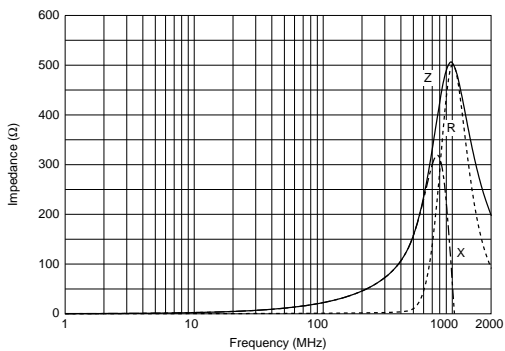

BLM15BB220SN1

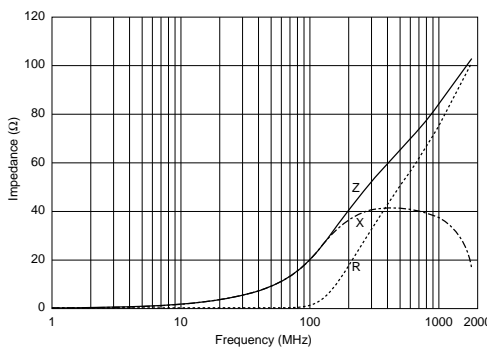

Continued on the following page. ↗

Continued from the preceding page.

Impedance - Frequency Characteristics

BLM15BA330SN1

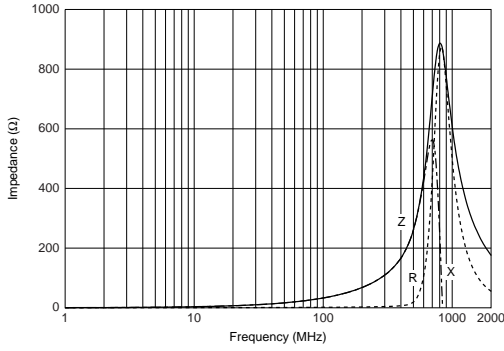

BLM15BA470SN1

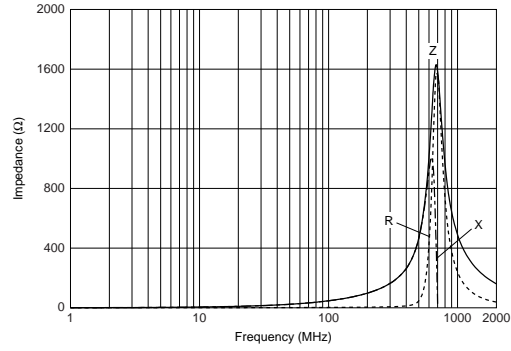

BLM15BB470SN1

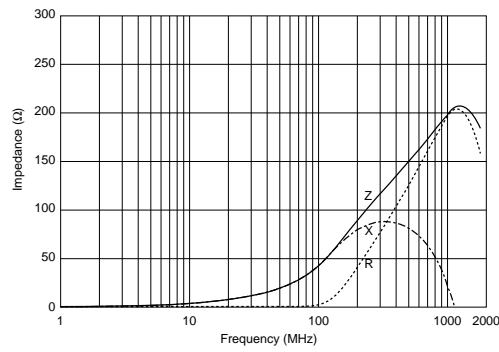

BLM15BA750SN1

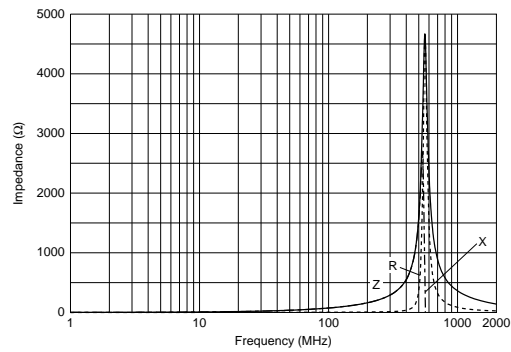

BLM15BB750SN1

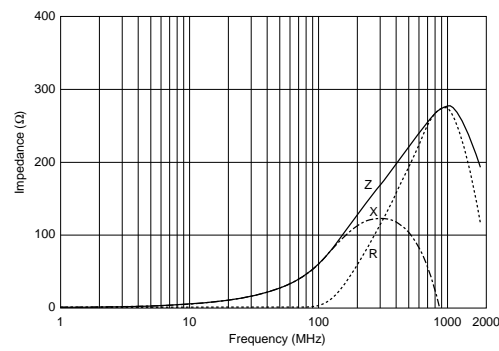

BLM15BD750SN1

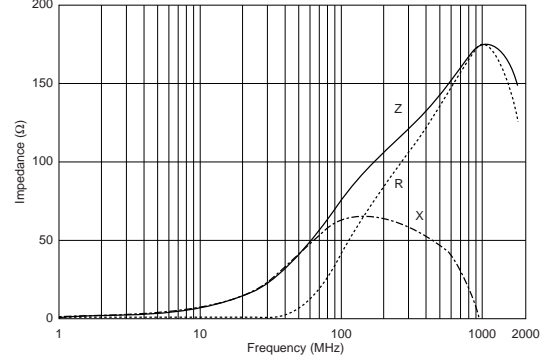

BLM15BB121SN1

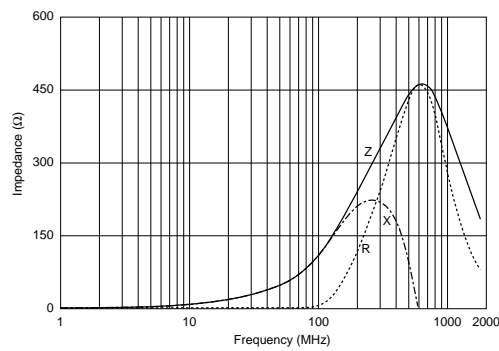

BLM15BD121SN1

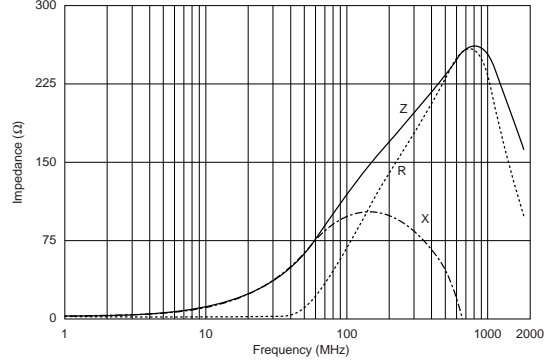

1

Continued from the preceding page.

Impedance - Frequency Characteristics

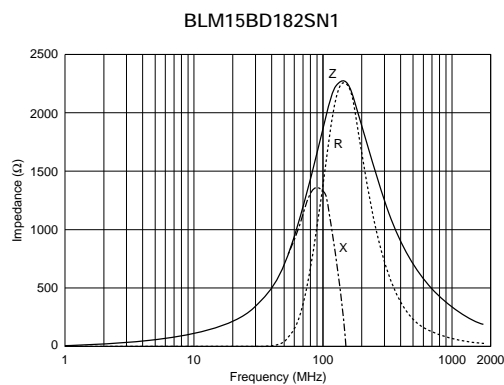
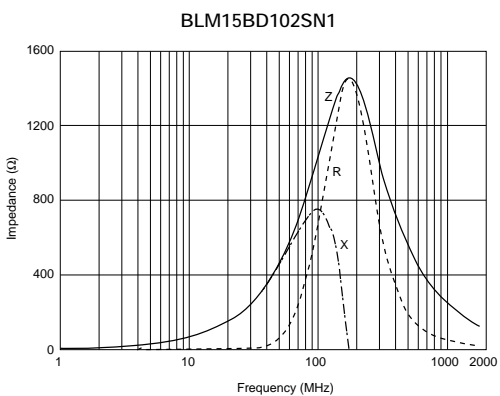
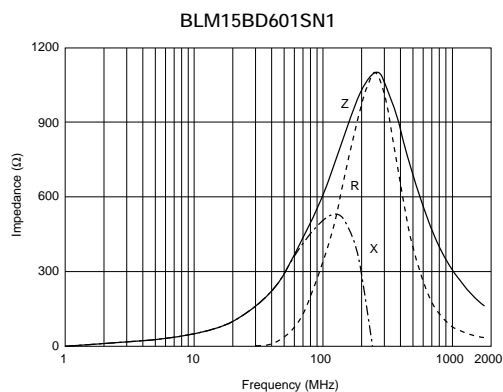
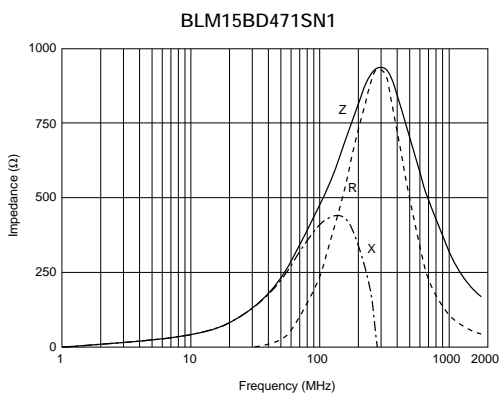
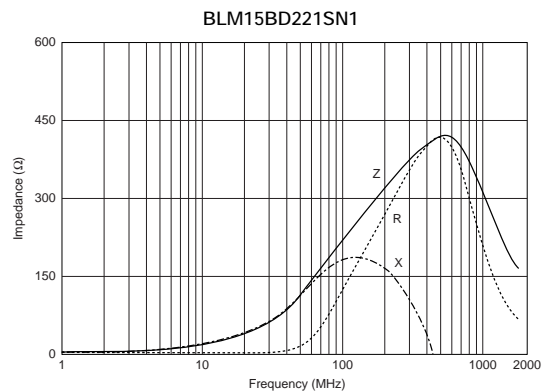
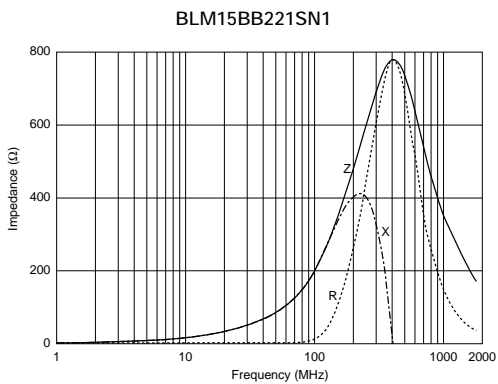

1

BLM18B Series (0603 Size)

1

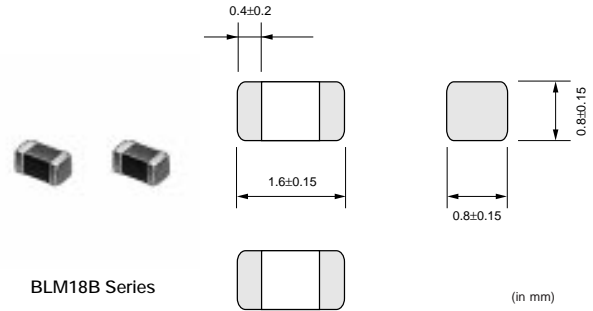

| Part Number | Impedance (at 100MHz/20°C) (ohm) | Rated Current (mA) | DC Resistance (max.) (ohm) | Operating Temperature Range (°C) |
|---------------|--|-----------------------|-------------------------------|--|
| BLM18BA050SN1 | 5 ±25% | 500 | 0.20 | -55 to +125 |
| BLM18BB050SN1 | 5 ±25% | 700 | 0.05 | -55 to +125 |
| BLM18BA100SN1 | 10 ±25% | 500 | 0.25 | -55 to +125 |
| BLM18BB100SN1 | 10 ±25% | 700 | 0.10 | -55 to +125 |
| BLM18BA220SN1 | 22 ±25% | 500 | 0.35 | -55 to +125 |
| BLM18BB220SN1 | 22 ±25% | 600 | 0.20 | -55 to +125 |
| BLM18BA470SN1 | 47 ±25% | 300 | 0.55 | -55 to +125 |
| BLM18BB470SN1 | 47 ±25% | 550 | 0.25 | -55 to +125 |
| BLM18BD470SN1 | 47 ±25% | 500 | 0.30 | -55 to +125 |
| BLM18BB600SN1 | 60 ±25% | 550 | 0.25 | -55 to +125 |
| BLM18BA750SN1 | 75 ±25% | 300 | 0.70 | -55 to +125 |
| BLM18BB750SN1 | 75 ±25% | 500 | 0.30 | -55 to +125 |
| BLM18BA121SN1 | 120 ±25% | 200 | 0.90 | -55 to +125 |
| BLM18BB121SN1 | 120 ±25% | 500 | 0.30 | -55 to +125 |
| BLM18BD121SN1 | 120 ±25% | 200 | 0.40 | -55 to +125 |
| BLM18BB141SN1 | 140 ±25% | 450 | 0.35 | -55 to +125 |
| BLM18BB151SN1 | 150 ±25% | 450 | 0.37 | -55 to +125 |
| BLM18BD151SN1 | 150 ±25% | 200 | 0.40 | -55 to +125 |
| BLM18BB221SN1 | 220 ±25% | 450 | 0.45 | -55 to +125 |
| BLM18BD221SN1 | 220 ±25% | 200 | 0.45 | -55 to +125 |
| BLM18BB331SN1 | 330 ±25% | 400 | 0.58 | -55 to +125 |
| BLM18BD331SN1 | 330 ±25% | 200 | 0.50 | -55 to +125 |
| BLM18BD421SN1 | 420 ±25% | 200 | 0.55 | -55 to +125 |
| BLM18BB471SN1 | 470 ±25% | 300 | 0.85 | -55 to +125 |
| BLM18BD471SN1 | 470 ±25% | 200 | 0.55 | -55 to +125 |
| BLM18BD601SN1 | 600 ±25% | 200 | 0.65 | -55 to +125 |
| BLM18BD102SN1 | 1000 ±25% | 100 | 0.85 | -55 to +125 |
| BLM18BD152SN1 | 1500 ±25% | 50 | 1.20 | -55 to +125 |
| BLM18BD182SN1 | 1800 ±25% | 50 | 1.50 | -55 to +125 |
| BLM18BD222SN1 | 2200 ±25% | 50 | 1.50 | -55 to +125 |
| BLM18BD252SN1 | 2500 ±25% | 50 | 1.50 | -55 to +125 |

■ Impedance - Frequency (Typical)

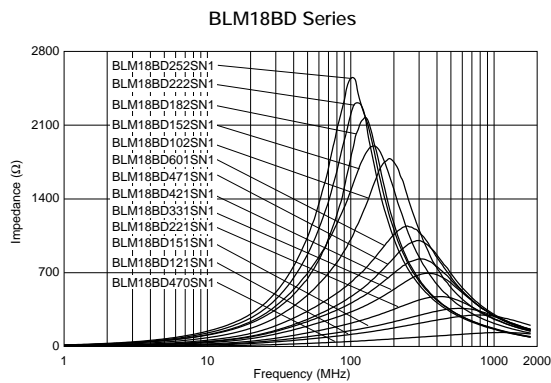
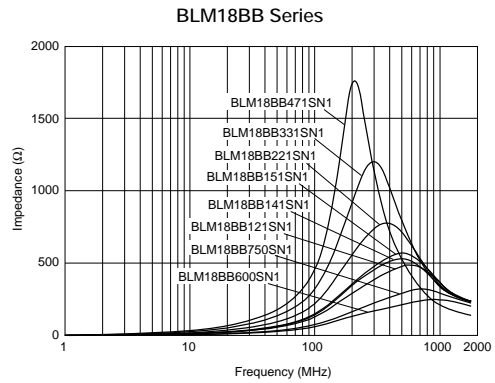
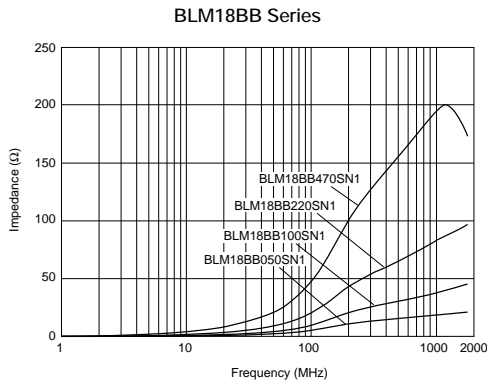
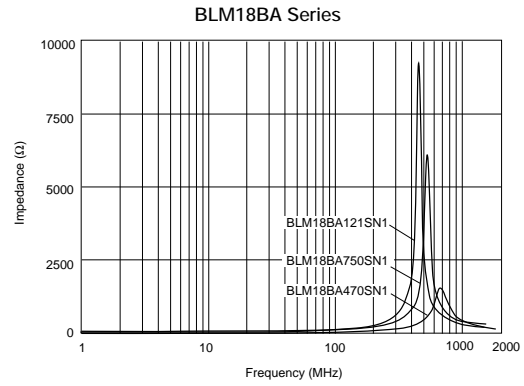
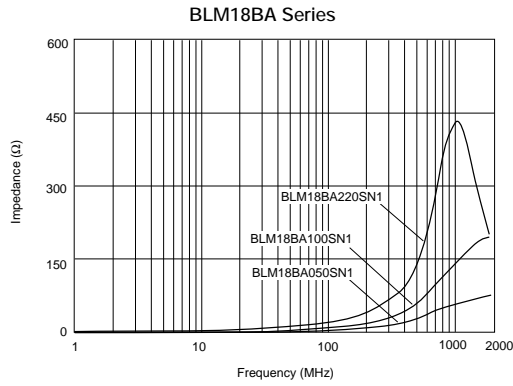

■ Impedance - Frequency Characteristics

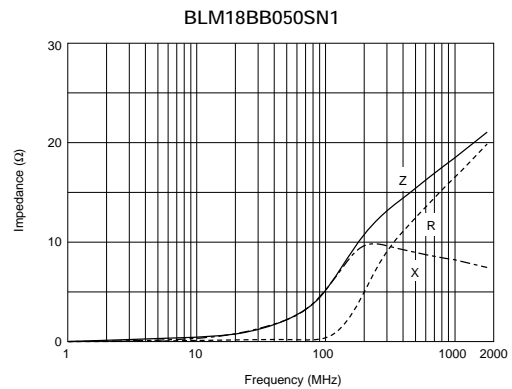
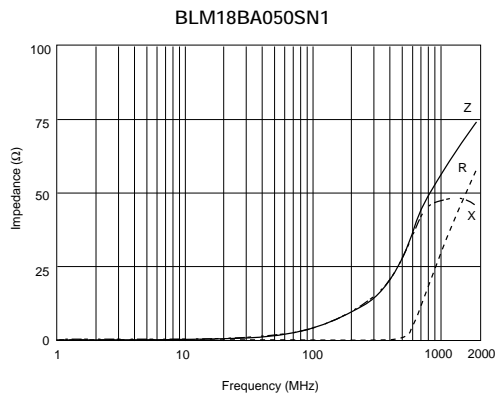

Continued on the following page.

Continued from the preceding page.

Impedance - Frequency Characteristics

BLM18BA100SN1

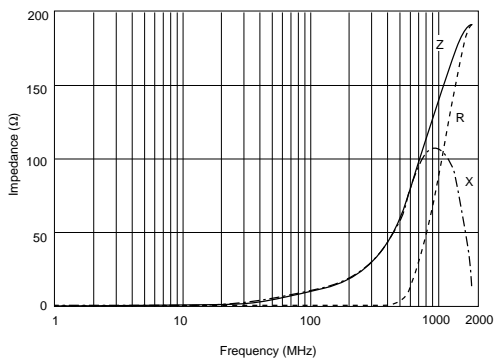

BLM18BB100SN1

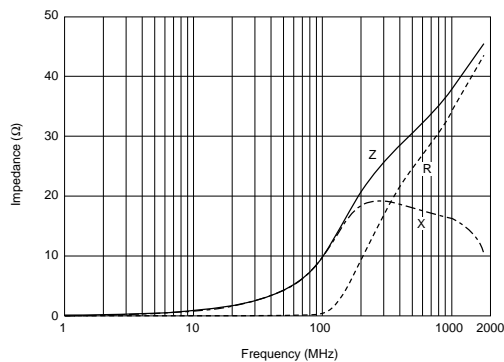

BLM18BA220SN1

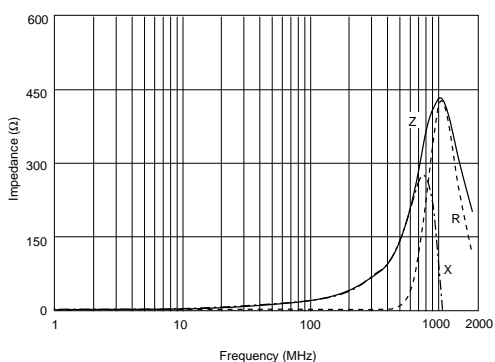

BLM18BB220SN1

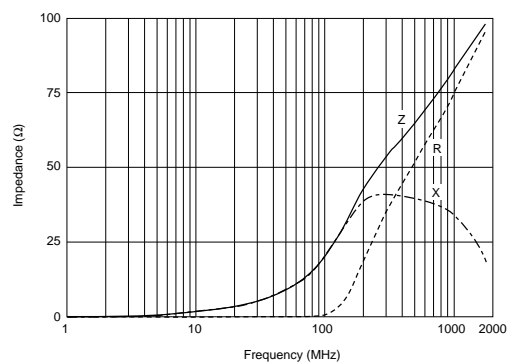

BLM18BA470SN1

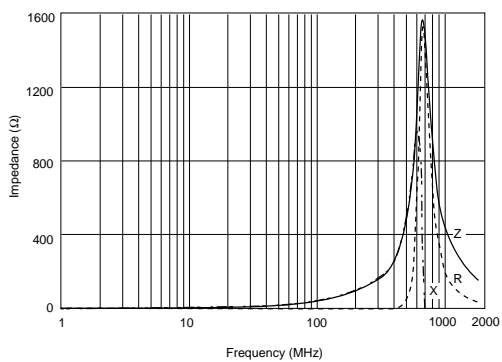

BLM18BB470SN1

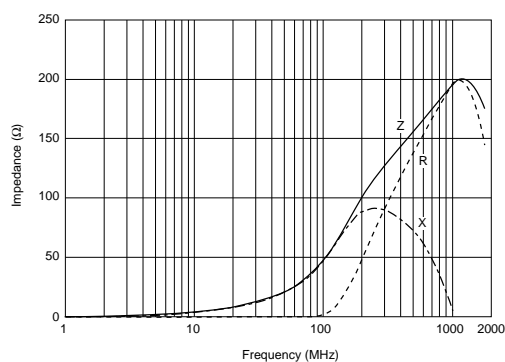

BLM18BD470SN1

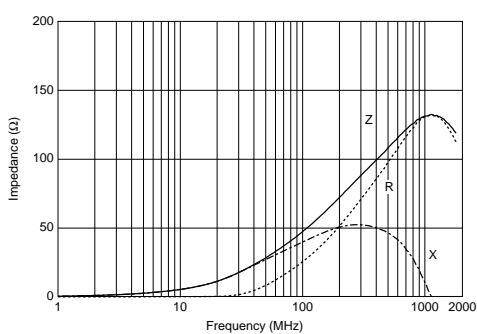

BLM18BB600SN1

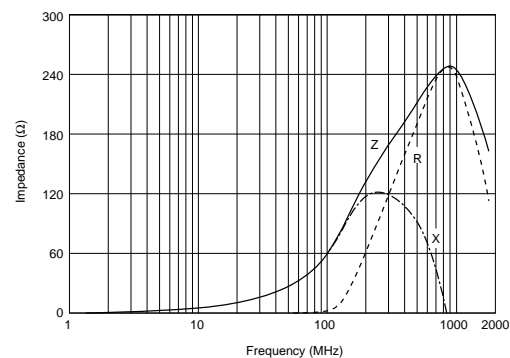

1

Continued from the preceding page.

Impedance - Frequency Characteristics

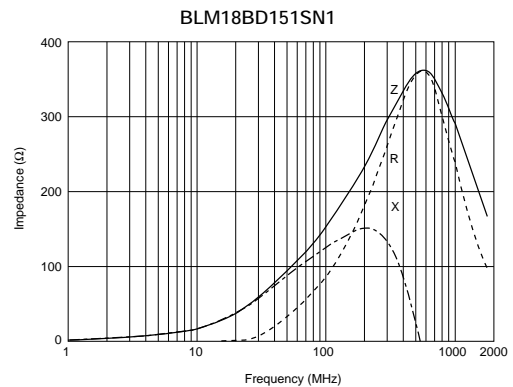
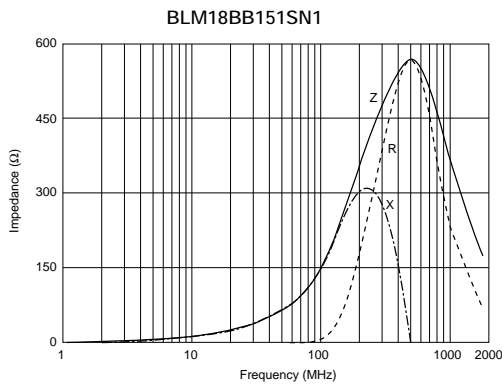
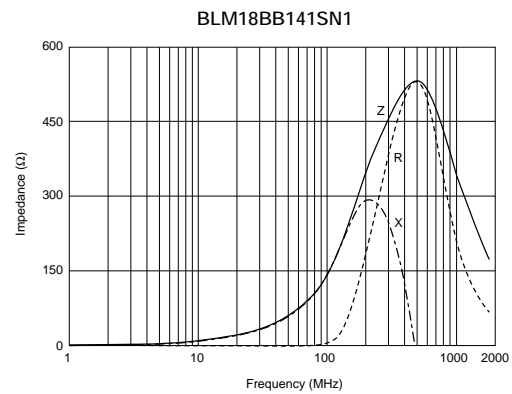
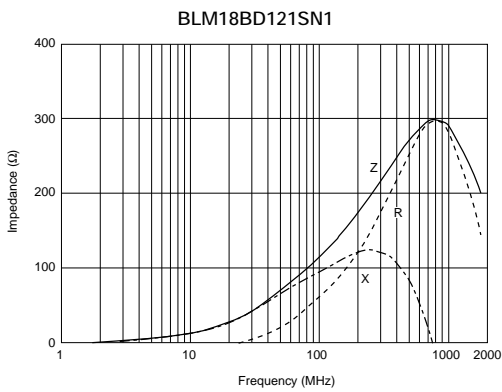
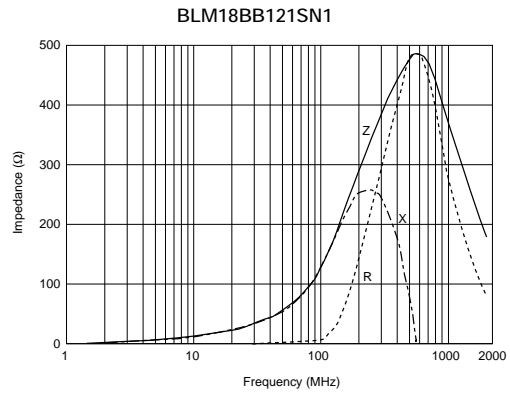
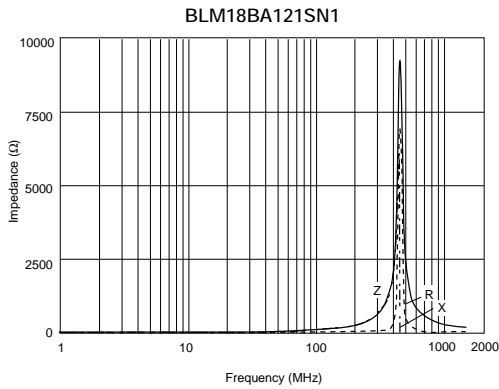
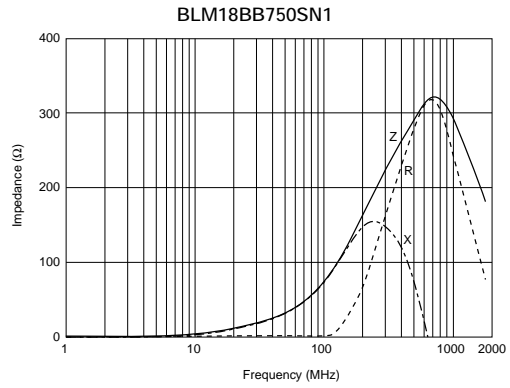
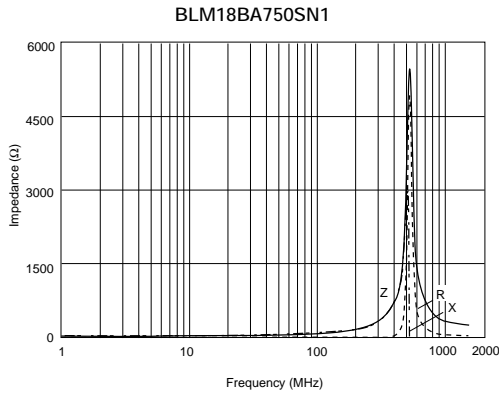

1

Continued on the following page. ↗

Continued from the preceding page.

Impedance - Frequency Characteristics

1

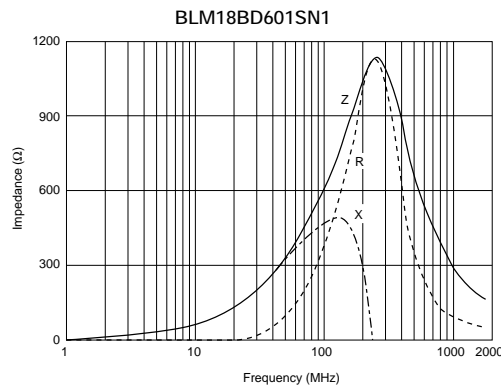
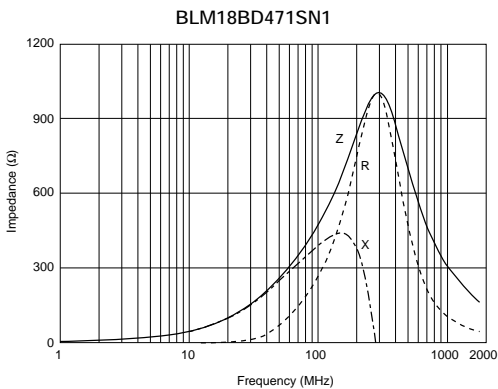
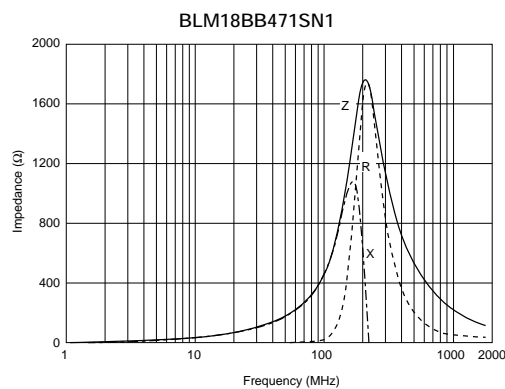
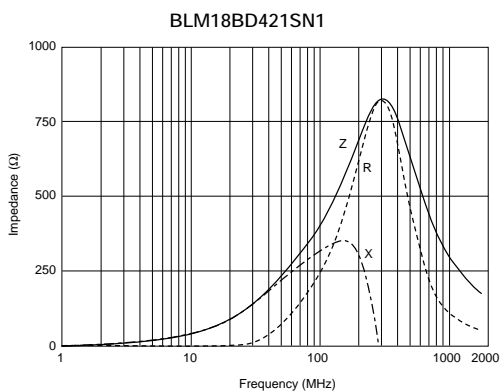
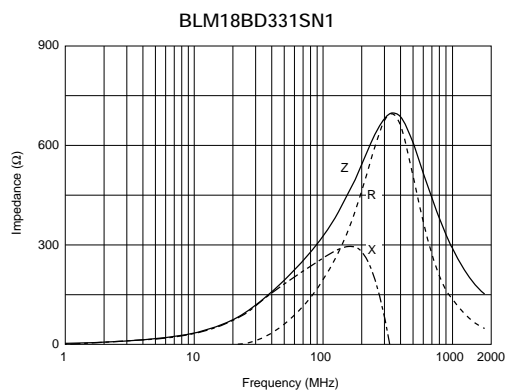
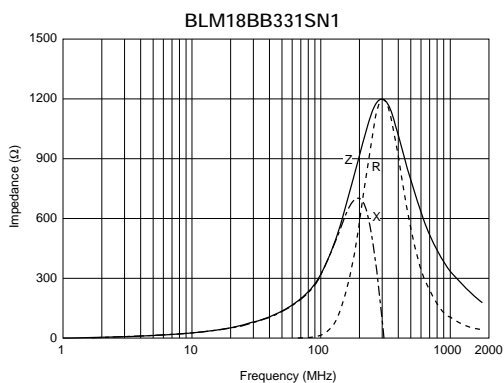
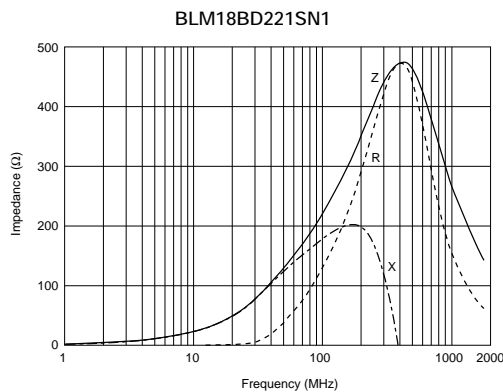
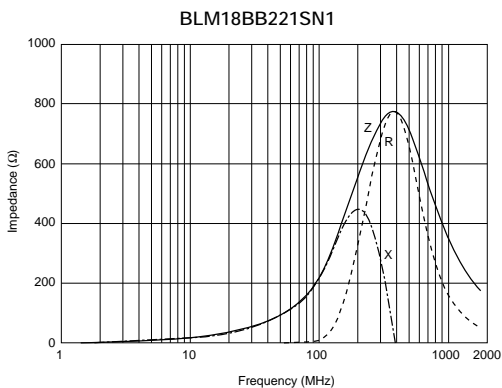

Continued on the following page. ↗

Continued from the preceding page.

Impedance - Frequency Characteristics

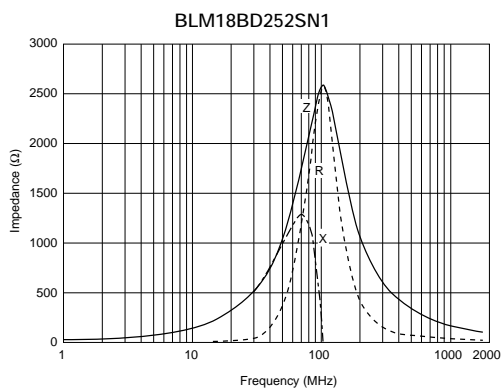
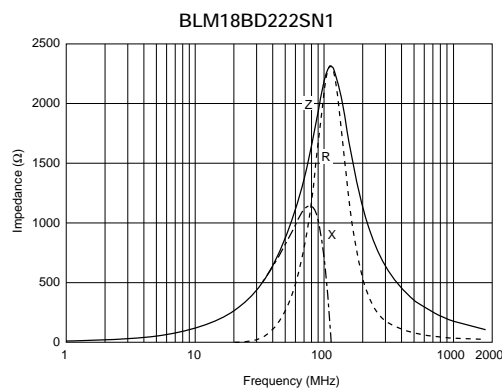
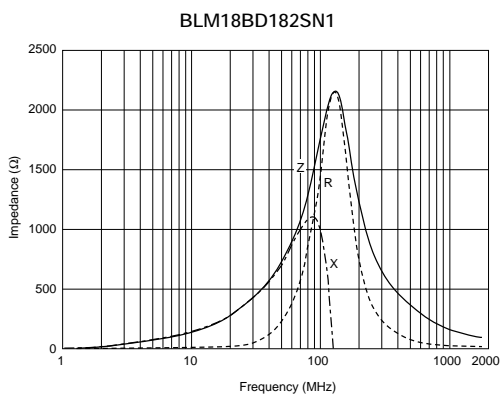
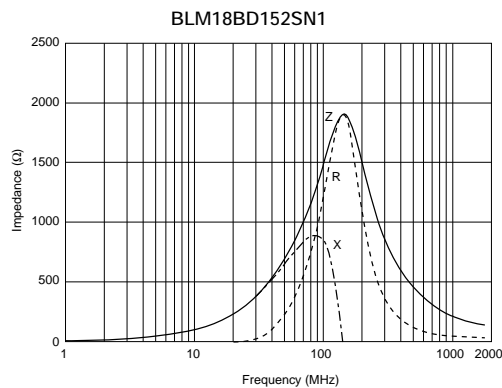
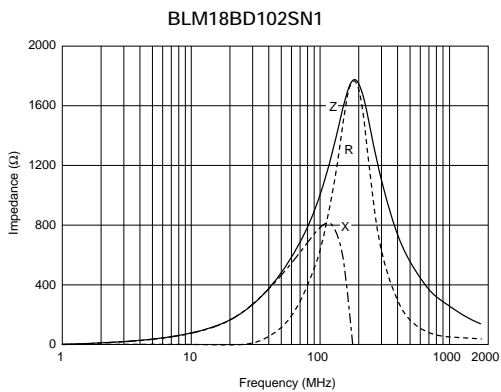

1

BLM21B Series (0805 Size)

1

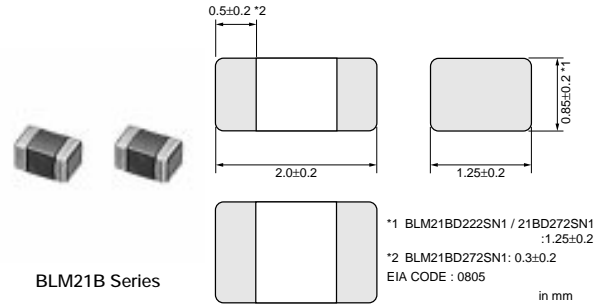

| Part Number | Impedance (at 100MHz/20°C) (ohm) | Rated Current (mA) | DC Resistance (max.) (ohm) | Operating Temperature Range (°C) |
|---------------|----------------------------------|--------------------|----------------------------|----------------------------------|
| BLM21BB050SN1 | 5 ±25% | 500 | 0.07 | -55 to +125 |
| BLM21BB600SN1 | 60 ±25% | 200 | 0.20 | -55 to +125 |
| BLM21BB750SN1 | 75 ±25% | 200 | 0.25 | -55 to +125 |
| BLM21BB121SN1 | 120 ±25% | 200 | 0.25 | -55 to +125 |
| BLM21BD121SN1 | 120 ±25% | 200 | 0.25 | -55 to +125 |
| BLM21BB151SN1 | 150 ±25% | 200 | 0.25 | -55 to +125 |
| BLM21BD151SN1 | 150 ±25% | 200 | 0.25 | -55 to +125 |
| BLM21BB201SN1 | 200 ±25% | 200 | 0.35 | -55 to +125 |
| BLM21BB221SN1 | 220 ±25% | 200 | 0.35 | -55 to +125 |
| BLM21BD221SN1 | 220 ±25% | 200 | 0.25 | -55 to +125 |
| BLM21BB331SN1 | 330 ±25% | 200 | 0.40 | -55 to +125 |
| BLM21BD331SN1 | 330 ±25% | 200 | 0.30 | -55 to +125 |
| BLM21BD421SN1 | 420 ±25% | 200 | 0.30 | -55 to +125 |
| BLM21BB471SN1 | 470 ±25% | 200 | 0.45 | -55 to +125 |
| BLM21BD471SN1 | 470 ±25% | 200 | 0.35 | -55 to +125 |
| BLM21BD601SN1 | 600 ±25% | 200 | 0.35 | -55 to +125 |
| BLM21BD751SN1 | 750 ±25% | 200 | 0.40 | -55 to +125 |
| BLM21BD102SN1 | 1000 ±25% | 200 | 0.40 | -55 to +125 |
| BLM21BD152SN1 | 1500 ±25% | 200 | 0.45 | -55 to +125 |
| BLM21BD182SN1 | 1800 ±25% | 200 | 0.50 | -55 to +125 |
| BLM21BD222TN1 | 2200 ±25% | 200 | 0.60 | -55 to +125 |
| BLM21BD222SN1 | 2250 (Typ.) | 200 | 0.60 | -55 to +125 |
| BLM21BD272SN1 | 2700 ±25% | 200 | 0.80 | -55 to +125 |

■ Impedance - Frequency (Typical)

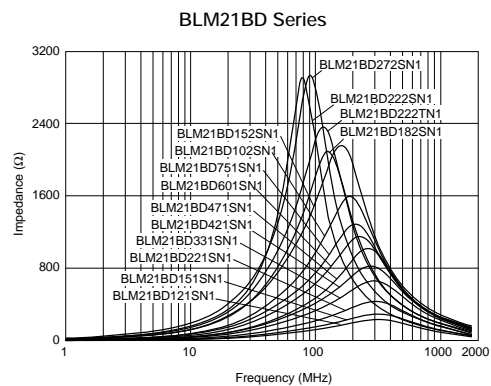
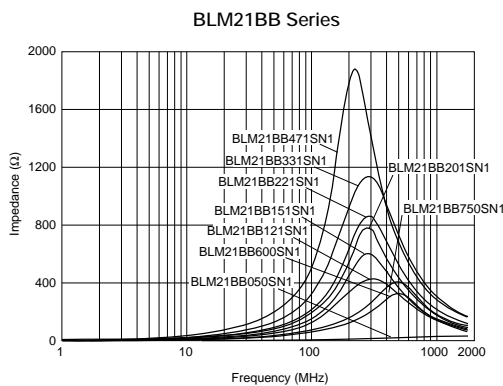

Continued on the following page. ↗

Continued from the preceding page.

Impedance - Frequency Characteristics

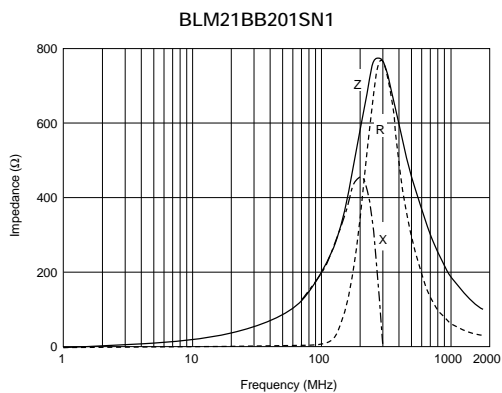
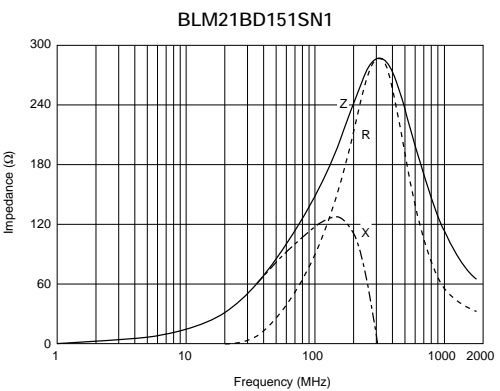
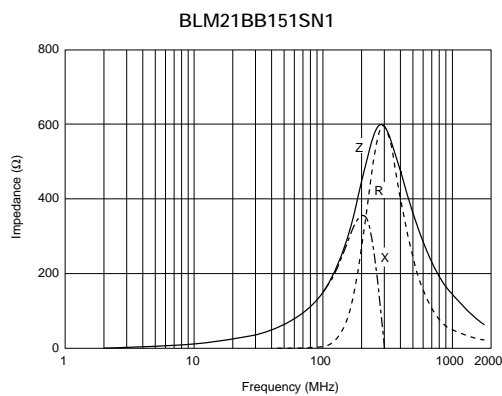
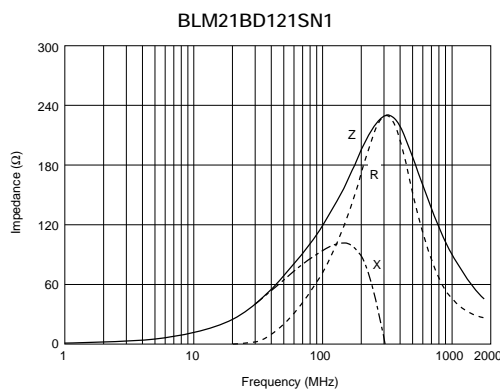
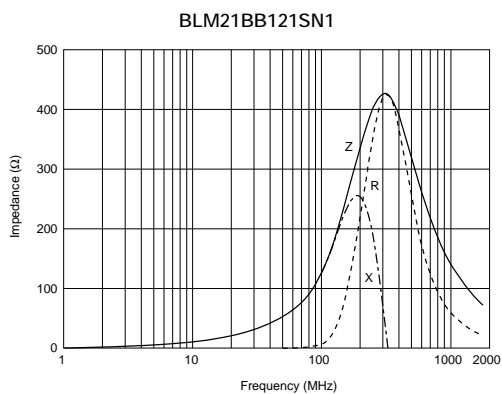
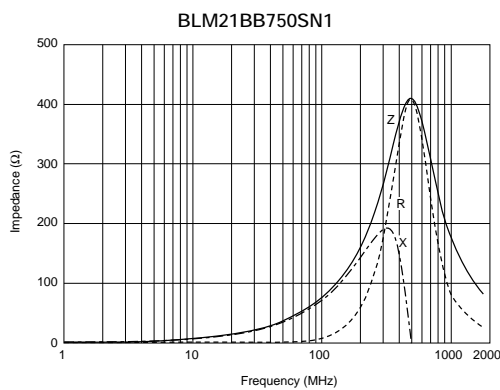
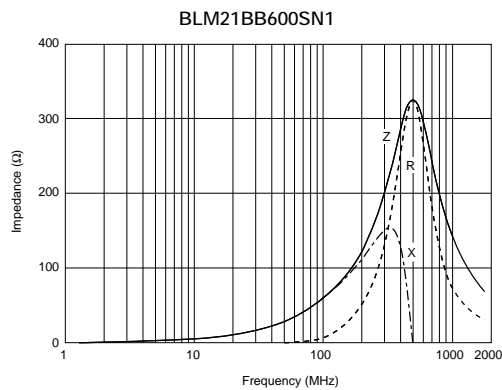
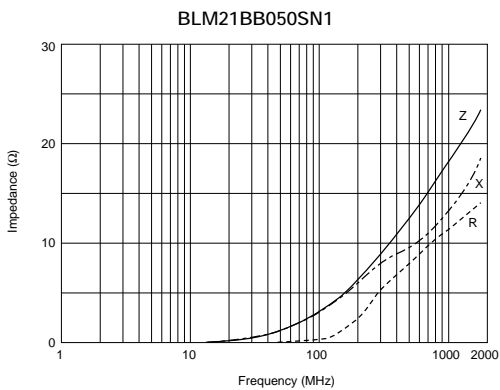

1

Continued on the following page. ↗

Continued from the preceding page.

Impedance - Frequency Characteristics

1

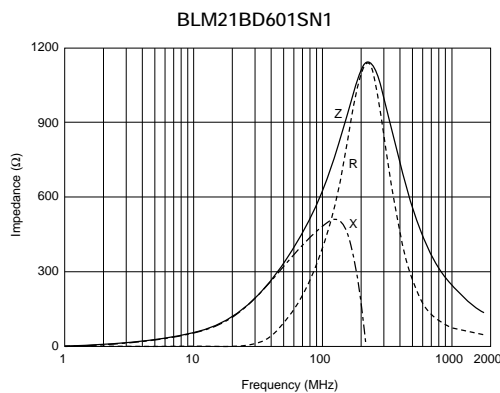
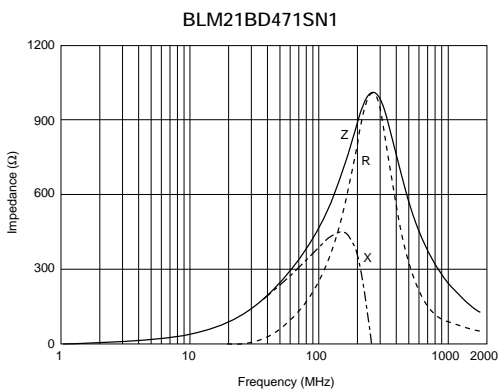
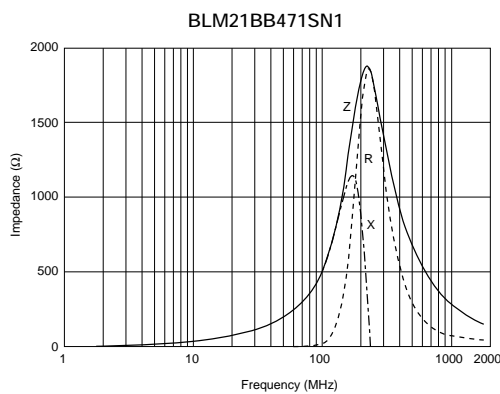
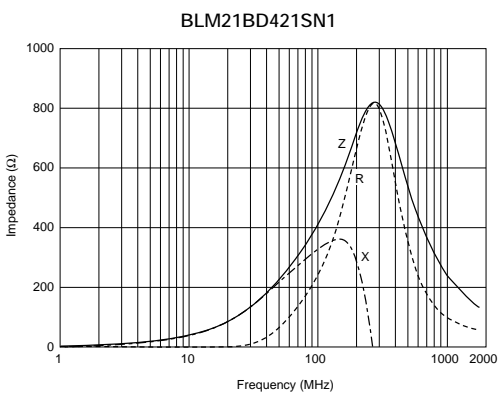
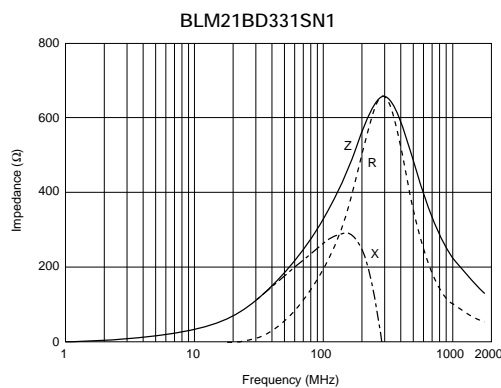
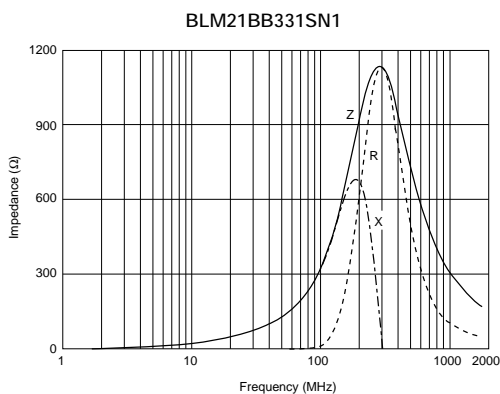
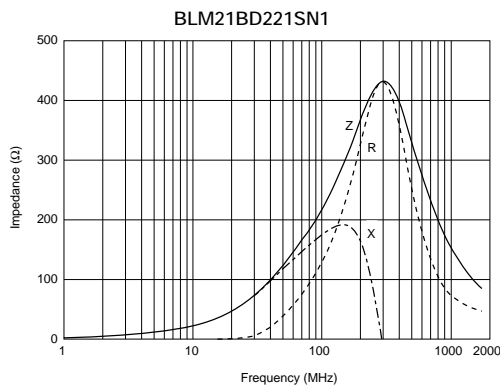
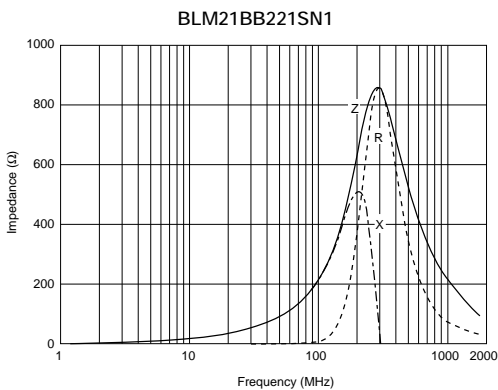

Continued on the following page. ↗

Continued from the preceding page.

■ Impedance - Frequency Characteristics

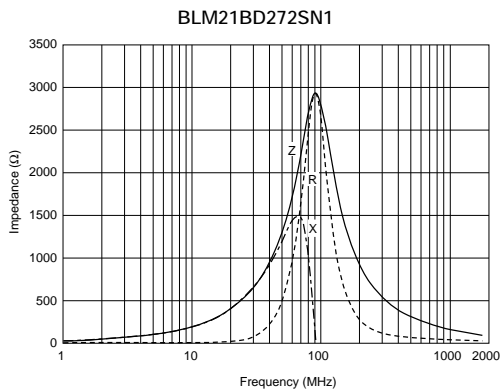
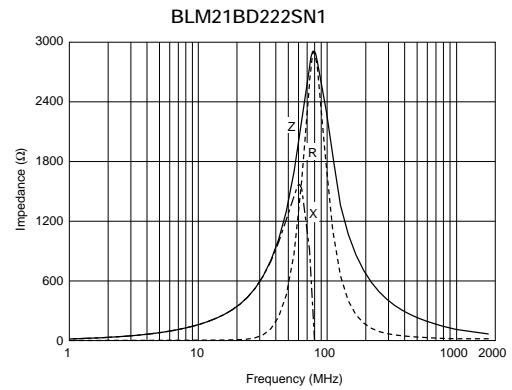
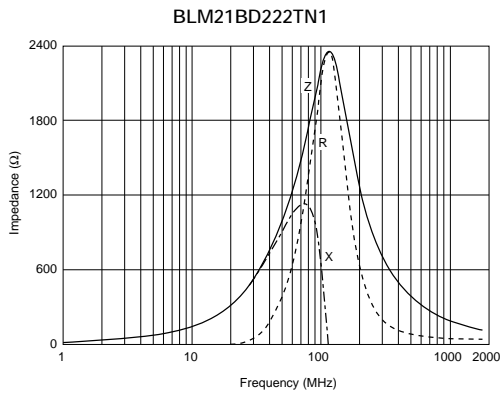
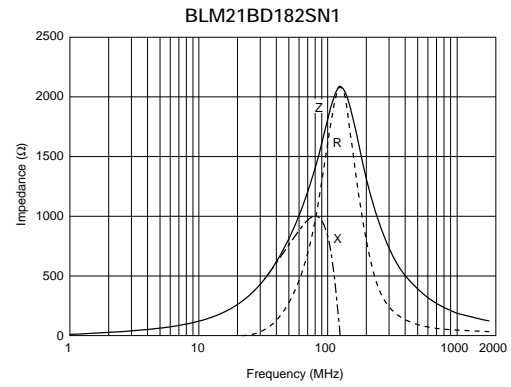
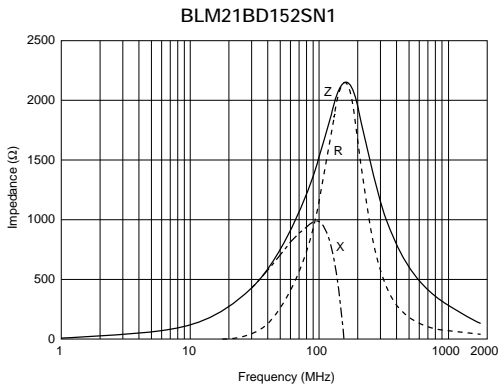
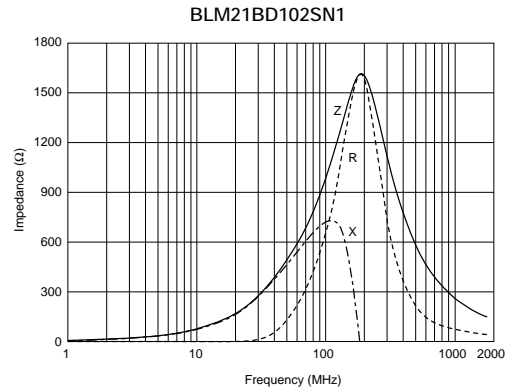
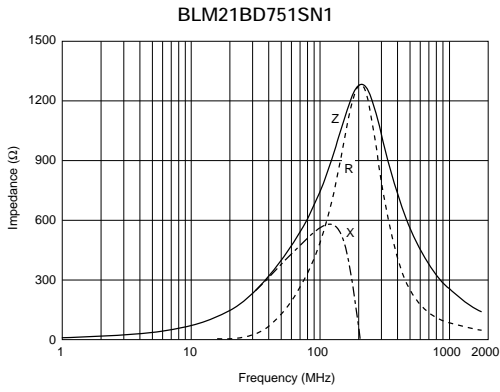

1

■ Features (BLM_R Series)

The chip ferrite beads BLM series is designed to function nearly as a resistor at noise frequencies, which greatly reduces the possibility of resonance and leaves signal wave forms undistorted.

BLM series is effective in circuits without stable ground lines because BLM series does not need a connection to ground.

The nickel barrier structure of the external electrodes provides excellent solder heat resistance. BLM_R series can be used in a digital Interface. Resistance of BLM_R series especially grows in the lower frequency range. Therefore BLM_R series is less effective for digital signal waveform at low frequency range and can suppress the ringing.

■ Equivalent Circuit

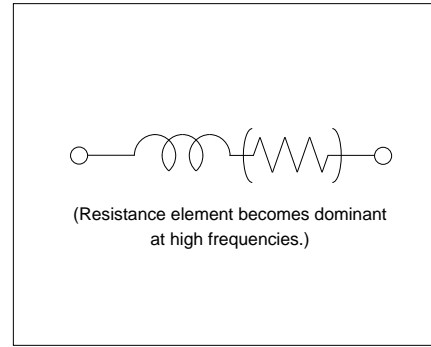

1

BLM18R Series (0603 Size)

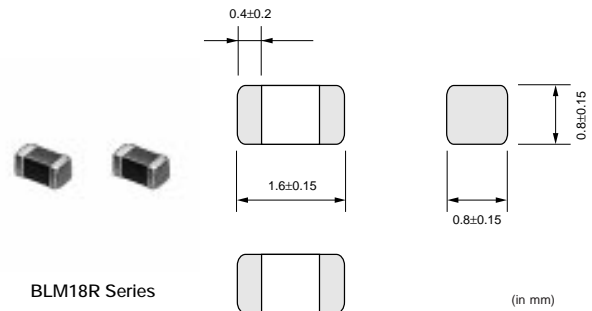

| Part Number | Impedance (at 100MHz/20°C) (ohm) | Rated Current (mA) | DC Resistance (max.) (ohm) | Operating Temperature Range (°C) |
|----------------------|----------------------------------|--------------------|----------------------------|----------------------------------|
| BLM18RK121SN1 | 120 ±25% | 200 | 0.25 | -55 to +125 |
| BLM18RK221SN1 | 220 ±25% | 200 | 0.30 | -55 to +125 |
| BLM18RK471SN1 | 470 ±25% | 200 | 0.50 | -55 to +125 |
| BLM18RK601SN1 | 600 ±25% | 200 | 0.60 | -55 to +125 |
| BLM18RK102SN1 | 1000 ±25% | 200 | 0.80 | -55 to +125 |

■ Impedance - Frequency (Typical)

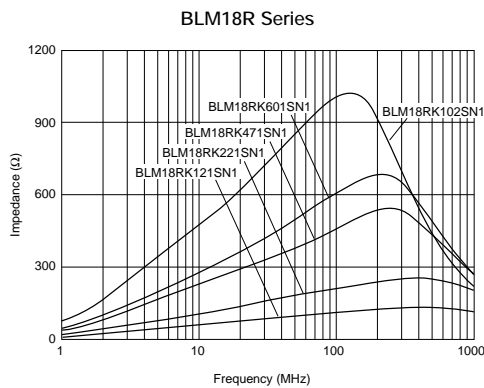

■ Impedance - Frequency Characteristics

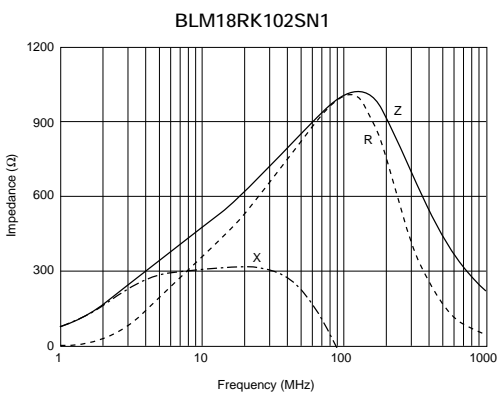
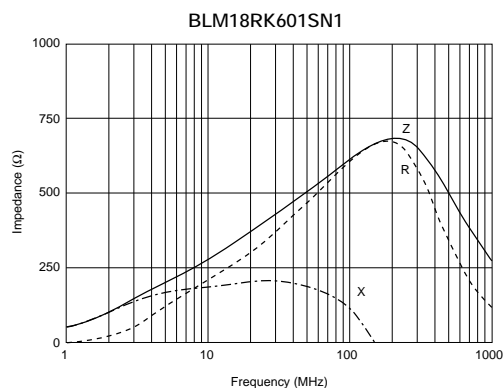
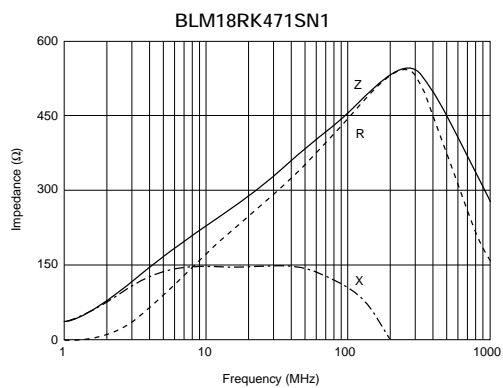
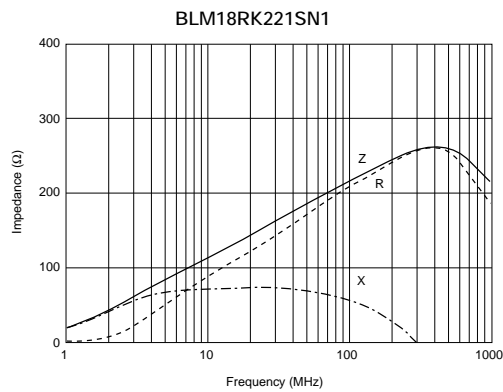
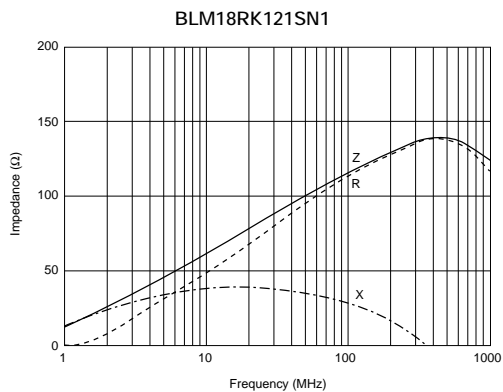

1

BLM21R Series (0805 Size)

1

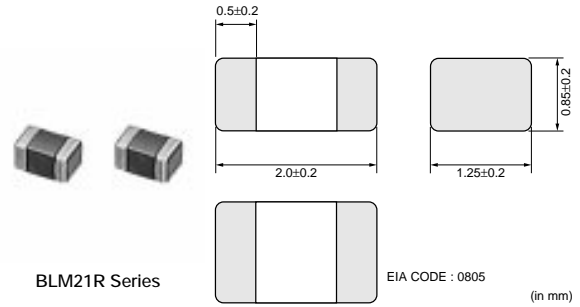

| Part Number | Impedance (at 100MHz/20°C) (ohm) | Rated Current (mA) | DC Resistance (max.) (ohm) | Operating Temperature Range (°C) |
|---------------|----------------------------------|--------------------|----------------------------|----------------------------------|
| BLM21RK121SN1 | 120 ±25% | 200 | 0.15 | -55 to +125 |
| BLM21RK221SN1 | 220 ±25% | 200 | 0.20 | -55 to +125 |
| BLM21RK471SN1 | 470 ±25% | 200 | 0.25 | -55 to +125 |
| BLM21RK601SN1 | 600 ±25% | 200 | 0.30 | -55 to +125 |
| BLM21RK102SN1 | 1000 ±25% | 200 | 0.50 | -55 to +125 |

■ Impedance - Frequency (Typical)

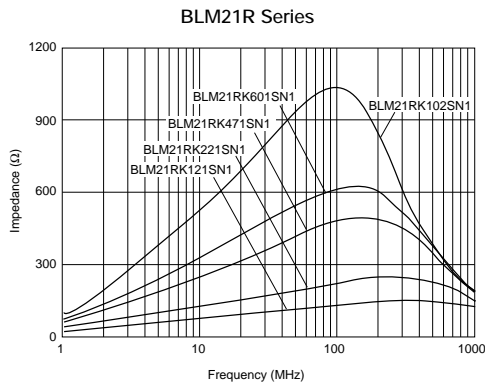

■ Impedance - Frequency Characteristics

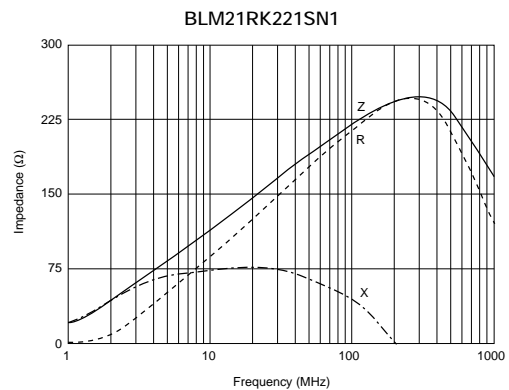
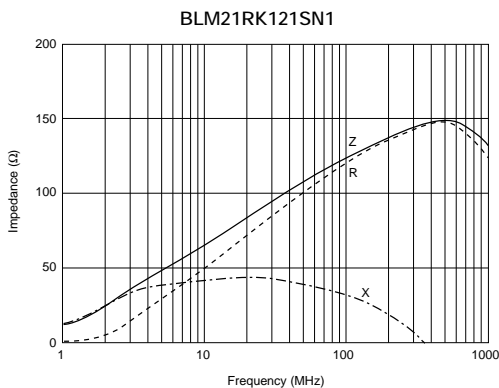

Continued on the following page. ↗

Continued from the preceding page.

Impedance - Frequency Characteristics

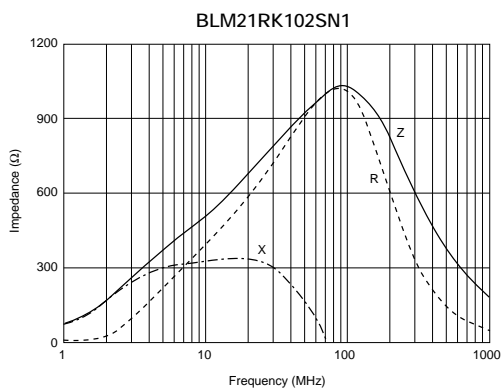
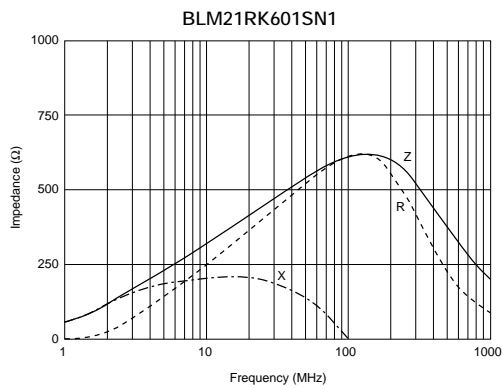
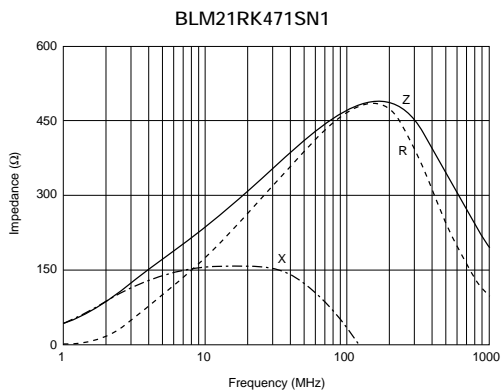

1

Noise Suppression Effect of BLM_R Series

Waveform Distortion Suppressing Performance of BLM□□R Series

1

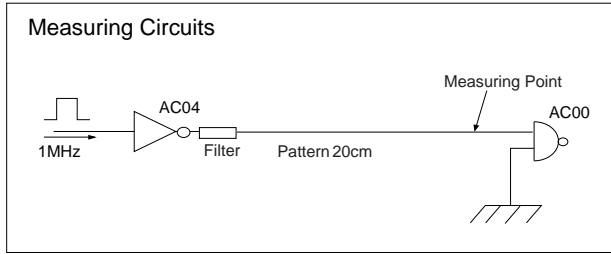

| Type of Filter | EMI Suppression Effect / Description | | |
|--|--|------------------------------------|-----------------|
| <p>Initial (No filter)</p> | <p>Signal waveform (100nsec/div, 2V/div)</p> | <p>Expand (10nsec/div, 2V/div)</p> | <p>Spectrum</p> |
| <p>Resistor (47Ω) is used</p> | <p>Signal waveform (100nsec/div, 2V/div)</p> | <p>Expand (10nsec/div, 2V/div)</p> | <p>Spectrum</p> |
| <p>BLM18RK221SN1 (220Ω at 100MHz) is used</p> | <p>Signal waveform (100nsec/div, 2V/div)</p> | <p>Expand (10nsec/div, 2V/div)</p> | <p>Spectrum</p> |

Ringing is caused on the signal waveform.
Such ringing contains several hundred MHz harmonic components and generates noise.

Comparing initial waveform, ringing is suppressed a little.
However there still remains high level waveform distortion.

BLM18R has excellent performance for noise suppression and waveform distortion suppression.
BLM18R suppresses drastically not only spectrum level in more than 100MHz range but waveform distortion.

■ Features (BLM_P Series)

The chip ferrite beads BLM series is designed to function nearly as a resistor at noise frequencies, which greatly reduces the possibility of resonance and leaves signal wave forms undistorted.

BLM series is effective in circuits without stable ground lines because BLM series does not need a connection to ground.

The nickel barrier structure of the external electrodes provides excellent solder heat resistance. BLM_P series can be used in high current circuits due to its low DC resistance. It can match power lines to a maximum of 6A DC.

The small size of BLM03A series (0.6x0.3mm) is suitable for noise suppression in small equipment such as PA modules for cellular phones.

■ Equivalent Circuit

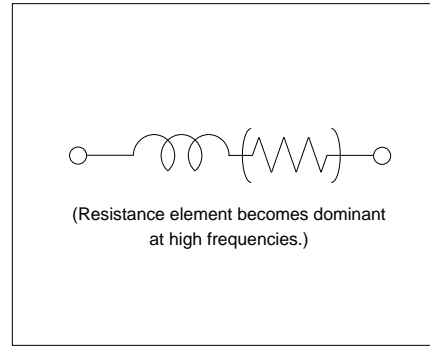

1

BLM03P Series (0201 Size)

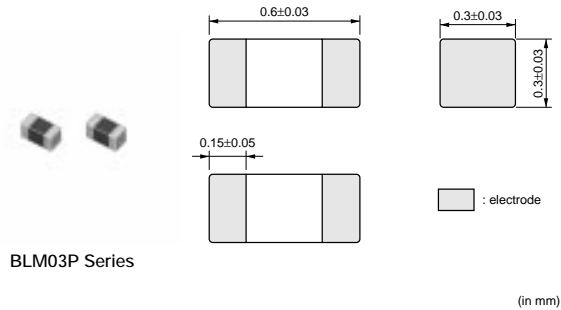

| Part Number | Impedance (at 100MHz/20°C) (ohm) | Rated Current (mA) | DC Resistance (max.) (ohm) | Operating Temperature Range (°C) |
|---------------|----------------------------------|--------------------|----------------------------|----------------------------------|
| BLM03PG220SN1 | 22 ±25% | 900 | 0.065 | -55 to +125 |
| BLM03PG330SN1 | 33 ±25% | 750 | 0.090 | -55 to +125 |

■ Impedance - Frequency (Typical)

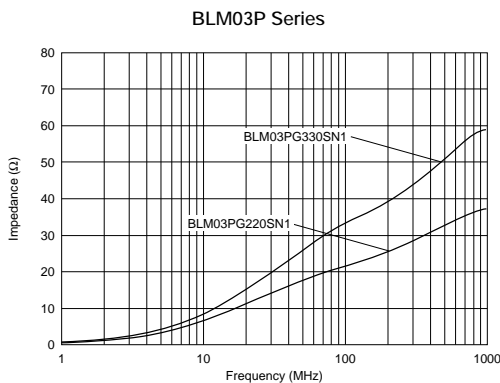

■ Impedance - Frequency Characteristics

BLM03PG220SN1

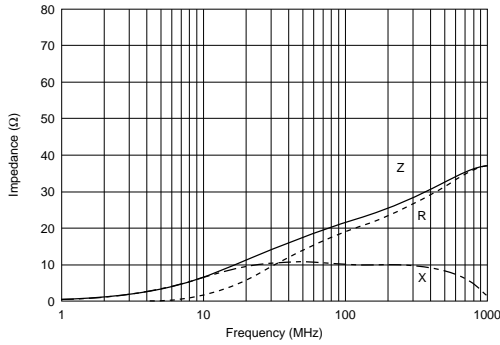

BLM03PG330SN1

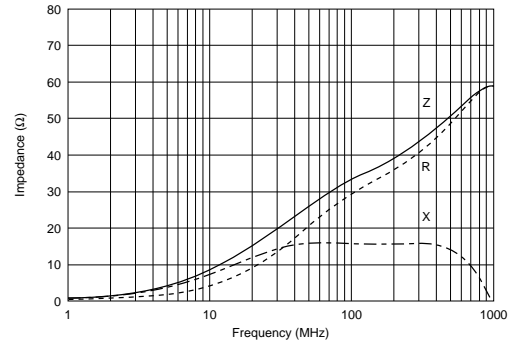

BLM15P Series (0402 Size)

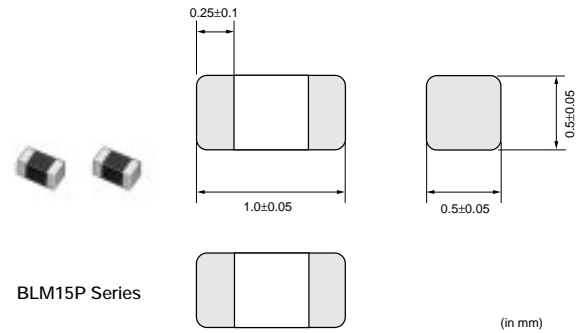

| Part Number | Impedance (at 100MHz/20°C) (ohm) | Rated Current (mA) | DC Resistance (max.) (ohm) | Operating Temperature Range (°C) |
|---------------|----------------------------------|--------------------|----------------------------|----------------------------------|
| BLM15PG100SN1 | 10 (Typ.) | 1000 | 0.05 | -55 to +125 |
| BLM15PD300SN1 | 30 ±25% | 2200 | 0.035 | -55 to +125 |
| BLM15PD600SN1 | 60 ±25% | 1700 | 0.06 | -55 to +125 |
| BLM15PD800SN1 | 80 ±25% | 1500 | 0.07 | -55 to +125 |
| BLM15PD121SN1 | 120 ±25% | 1300 | 0.09 | -55 to +125 |

In operating temperature exceeding +85°C, derating of current is necessary for BLM15PD series. Please refer to p.57, "Derating of Rated Current".

■ Impedance - Frequency (Typical)

BLM15P Series

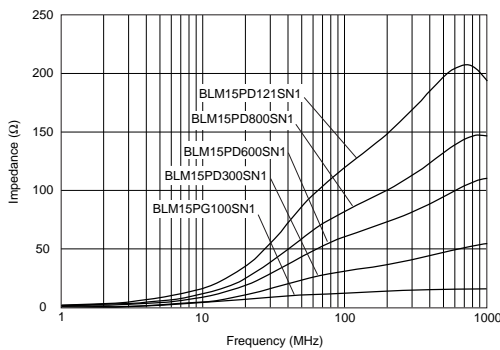

■ Impedance - Frequency Characteristics

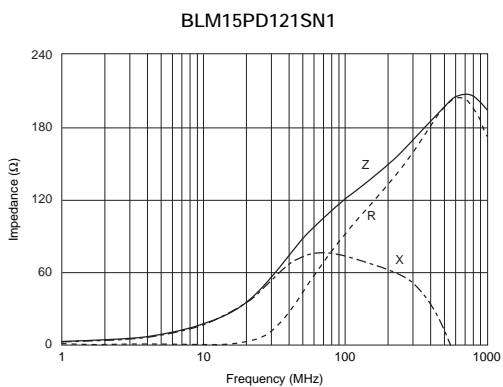
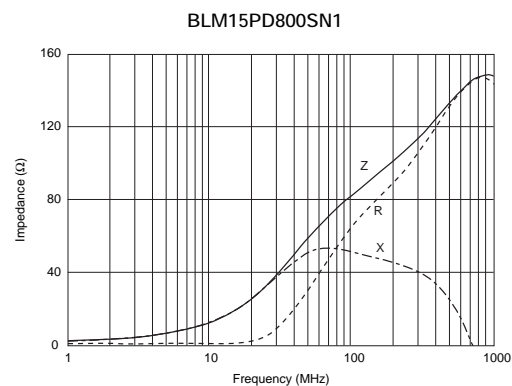
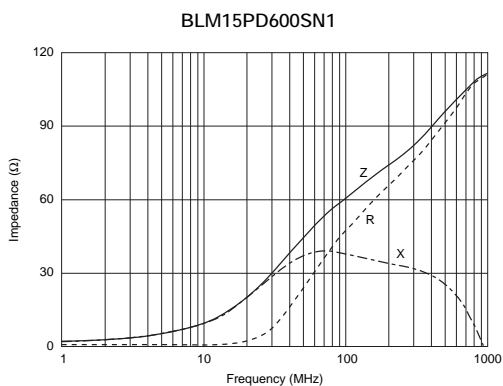
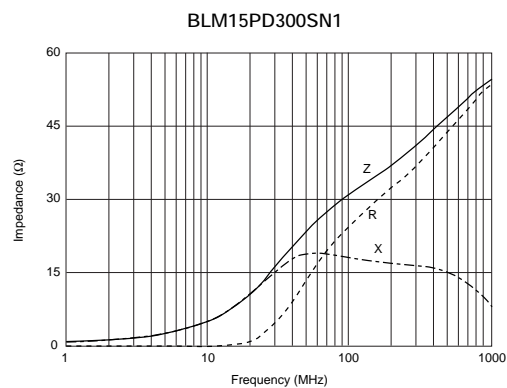
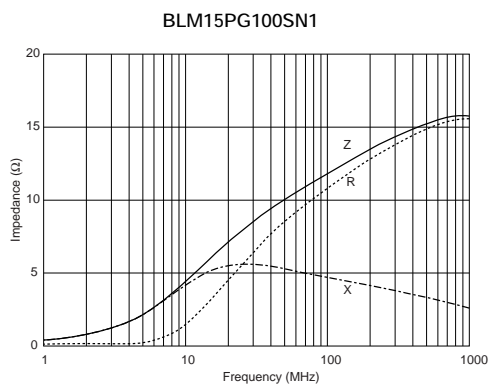

■ Notice (Rating)

In operating temperature exceeding +85°C, derating of current is necessary for BLM15PD series.
 Please apply the derating curve shown in chart according to the operating temperature.

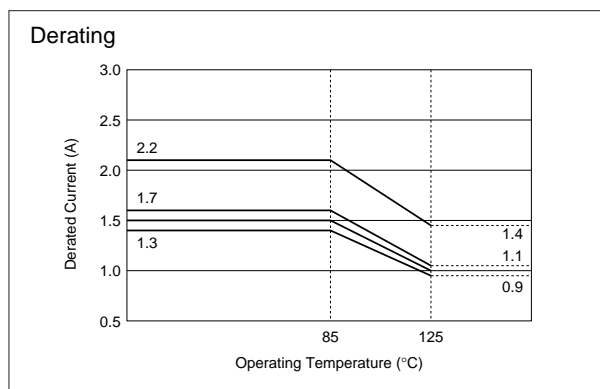

1

BLM18P Series (0603 Size)

1

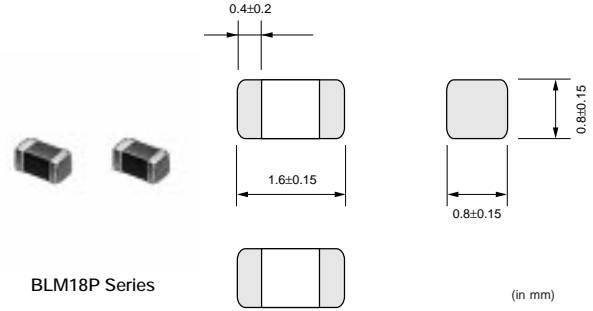

| Part Number | Impedance (at 100MHz/20°C) (ohm) | Rated Current (mA) | DC Resistance (max.) (ohm) | Operating Temperature Range (°C) |
|----------------------|----------------------------------|--------------------|----------------------------|----------------------------------|
| BLM18PG300SN1 | 30 (Typ.) | 1000 | 0.05 | -55 to +125 |
| BLM18PG330SN1 | 33 ±25% | 3000 | 0.025 | -55 to +125 |
| BLM18PG600SN1 | 60 (Typ.) | 500 | 0.10 | -55 to +125 |
| BLM18PG121SN1 | 120 ±25% | 2000 | 0.05 | -55 to +125 |
| BLM18PG181SN1 | 180 ±25% | 1500 | 0.09 | -55 to +125 |
| BLM18PG221SN1 | 220 ±25% | 1400 | 0.10 | -55 to +125 |
| BLM18PG331SN1 | 330 ±25% | 1200 | 0.15 | -55 to +125 |
| BLM18PG471SN1 | 470 ±25% | 1000 | 0.20 | -55 to +125 |

For the items of rated current higher than 1200mA, derating is required. Please refer to p.68, "Derating of Rated Current".

■ Impedance - Frequency (Typical)

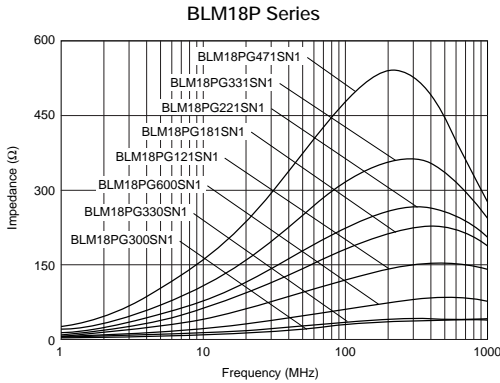

■ Impedance - Frequency Characteristics

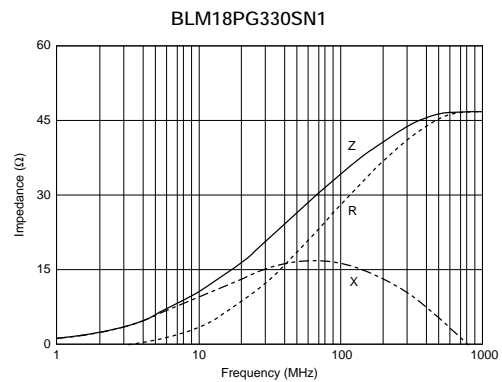
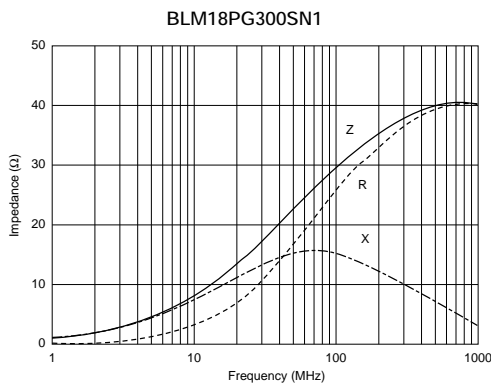

Continued on the following page. ↗

Continued from the preceding page.

Impedance - Frequency Characteristics

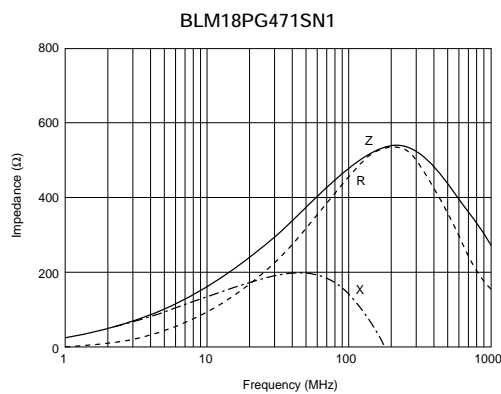
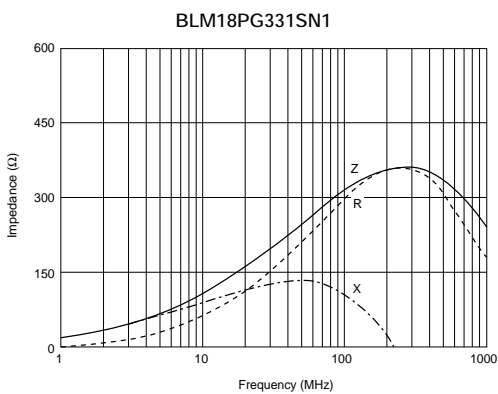
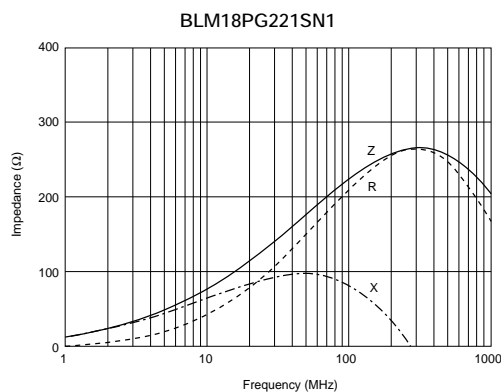
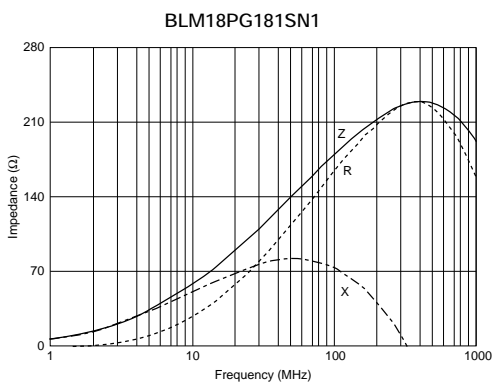
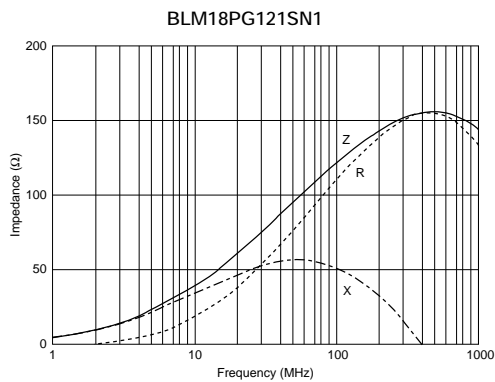
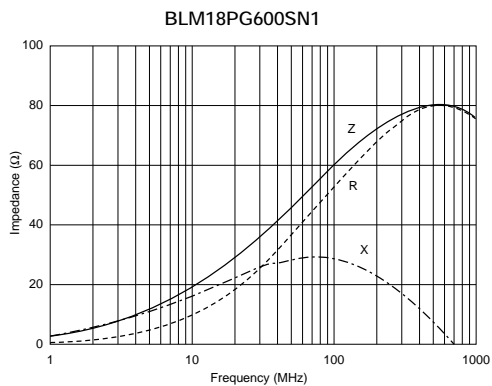

1

BLM21P Series (0805 Size)

1

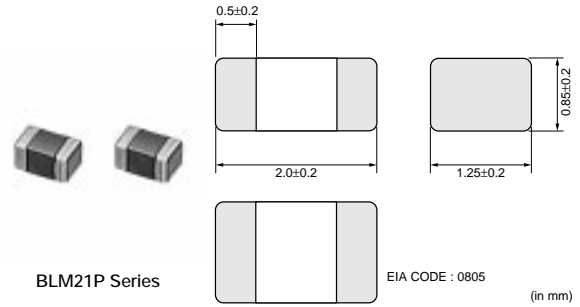

| Part Number | Impedance (at 100MHz/20°C) (ohm) | Rated Current (mA) | DC Resistance (max.) (ohm) | Operating Temperature Range (°C) |
|----------------------|----------------------------------|--------------------|----------------------------|----------------------------------|
| BLM21PG220SN1 | 22 ±25% | 6000 | 0.01 | -55 to +125 |
| BLM21PG300SN1 | 30 (Typ.) | 3000 | 0.015 | -55 to +125 |
| BLM21PG600SN1 | 60 ±25% | 3000 | 0.025 | -55 to +125 |
| BLM21PG221SN1 | 220 ±25% | 2000 | 0.050 | -55 to +125 |
| BLM21PG331SN1 | 330 ±25% | 1500 | 0.09 | -55 to +125 |

For the items of rated current higher than 1500mA, derating is required. Please refer to p.68, "Derating of Rated Current".

■ Impedance - Frequency (Typical)

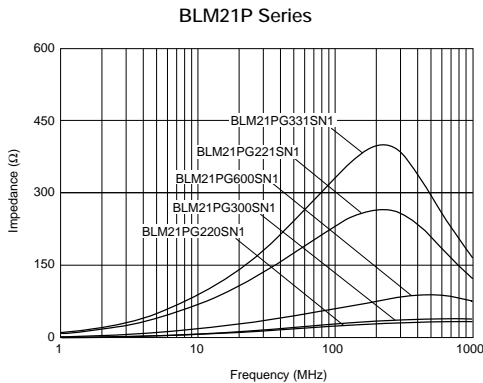

■ Impedance - Frequency Characteristics

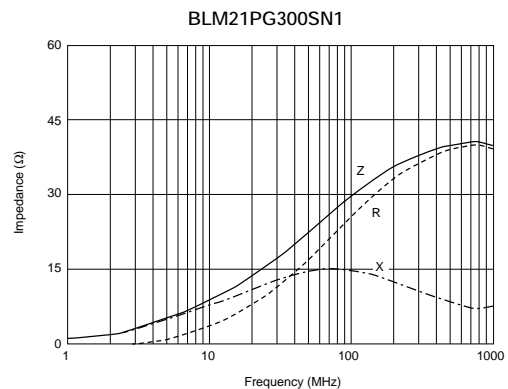
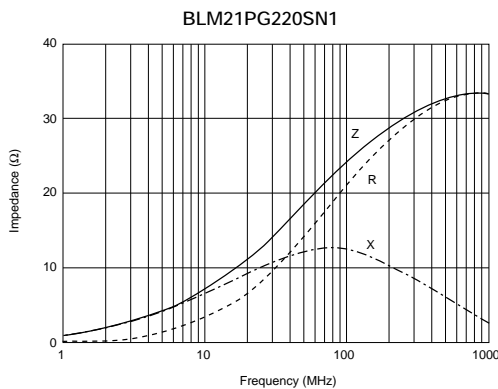

Continued on the following page. ↗

Continued from the preceding page.

Impedance - Frequency Characteristics

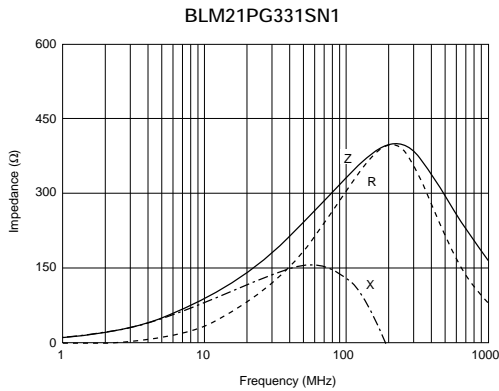
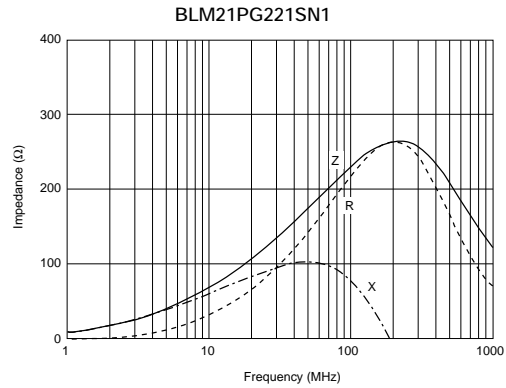
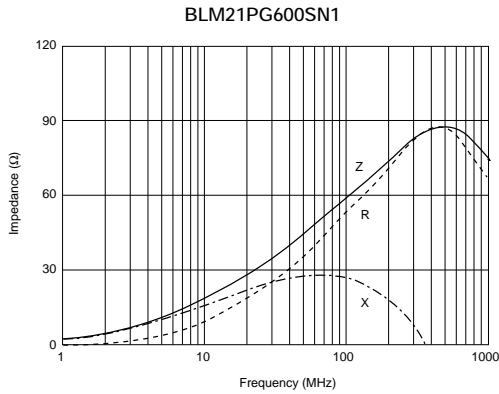

1

BLM31P Series (1206 Size)

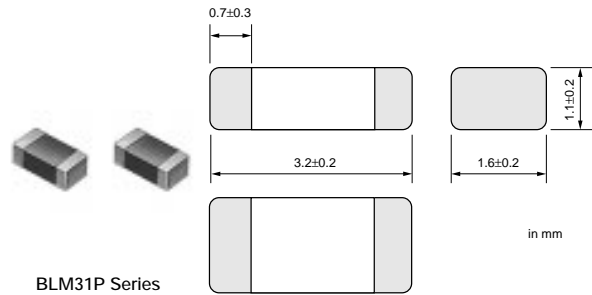

| Part Number | Impedance (at 100MHz/20°C) (ohm) | Rated Current (mA) | DC Resistance (max.) (ohm) | Operating Temperature Range (°C) |
|----------------------|----------------------------------|--------------------|----------------------------|----------------------------------|
| BLM31PG330SN1 | 33 ±25% | 6000 | 0.01 | -55 to +125 |
| BLM31PG500SN1 | 50 (Typ.) | 3000 | 0.025 | -55 to +125 |
| BLM31PG121SN1 | 120 ±25% | 3000 | 0.025 | -55 to +125 |
| BLM31PG391SN1 | 390 ±25% | 2000 | 0.05 | -55 to +125 |
| BLM31PG601SN1 | 600 ±25% | 1500 | 0.09 | -55 to +125 |

For the items of rated current higher than 1500mA, derating is required. Please refer to p.68, "Derating of Rated Current".

■ Impedance - Frequency (Typical)

BLM31P Series

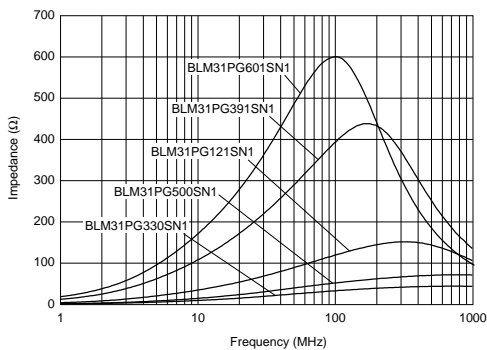

1

■ Impedance - Frequency Characteristics

BLM31PG330SN1

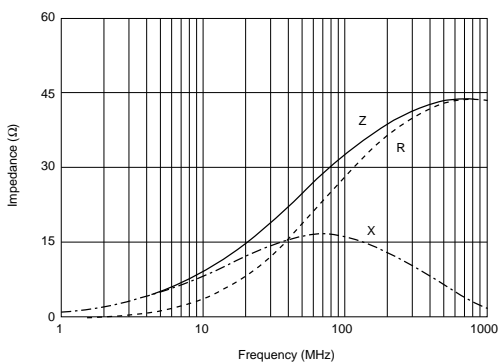

BLM31PG500SN1

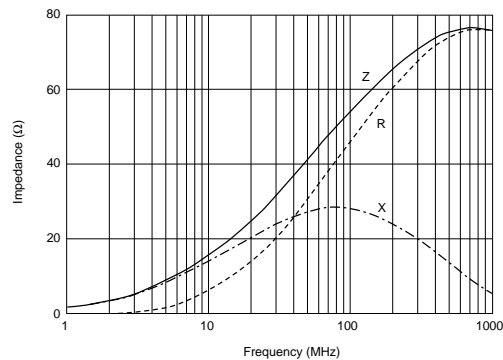

BLM31PG121SN1

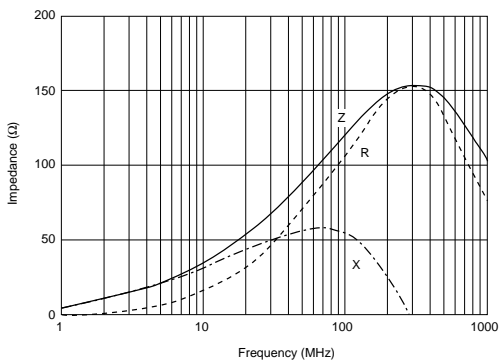

BLM31PG391SN1

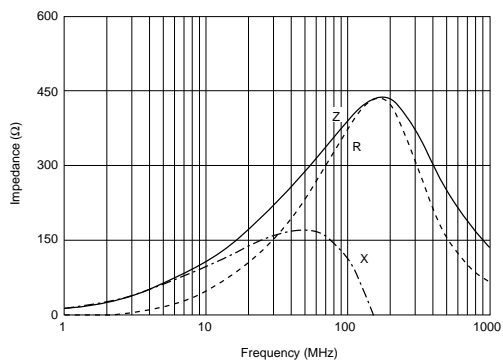

BLM31PG601SN1

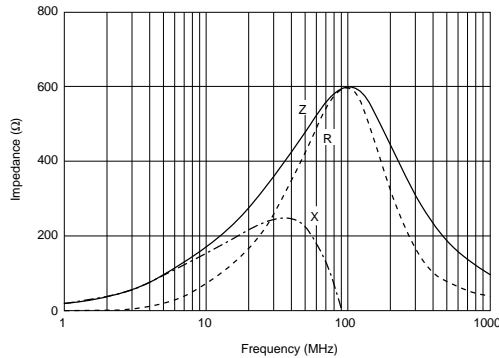

BLM41P Series (1806 Size)

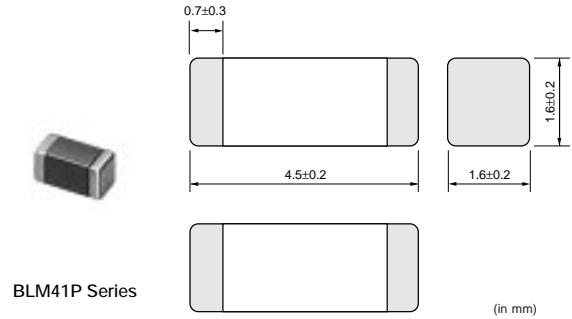

1

| Part Number | Impedance (at 100MHz/20°C) (ohm) | Rated Current (mA) | DC Resistance (max.) (ohm) | Operating Temperature Range (°C) |
|---------------|----------------------------------|--------------------|----------------------------|----------------------------------|
| BLM41PG600SN1 | 60 (Typ.) | 6000 | 0.01 | -55 to +125 |
| BLM41PG750SN1 | 75 (Typ.) | 3000 | 0.025 | -55 to +125 |
| BLM41PG181SN1 | 180 ±25% | 3000 | 0.025 | -55 to +125 |
| BLM41PG471SN1 | 470 ±25% | 2000 | 0.05 | -55 to +125 |
| BLM41PG102SN1 | 1000 ±25% | 1500 | 0.09 | -55 to +125 |

For the items of rated current higher than 1500mA, derating is required. Please refer to p.68, "Derating of Rated Current".

■ Impedance - Frequency (Typical)

BLM41P Series (60-180ohm)

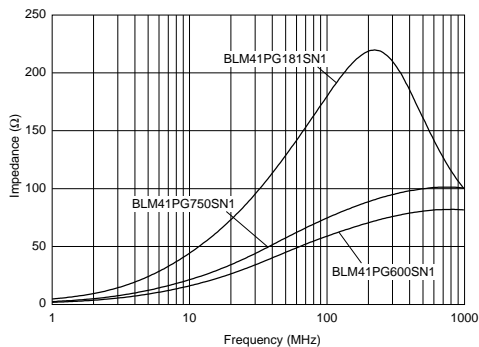

BLM41P Series (470-1000ohm)

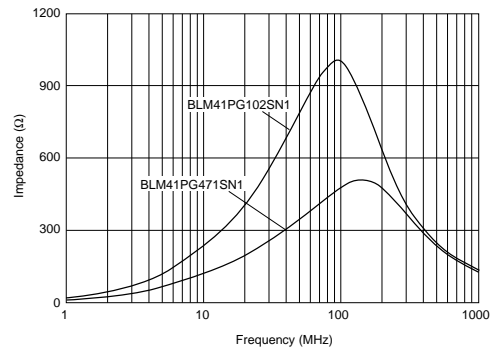

■ Impedance - Frequency Characteristics

BLM41PG600SN1

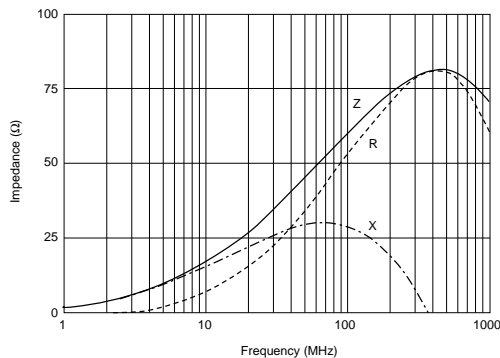

BLM41PG750SN1

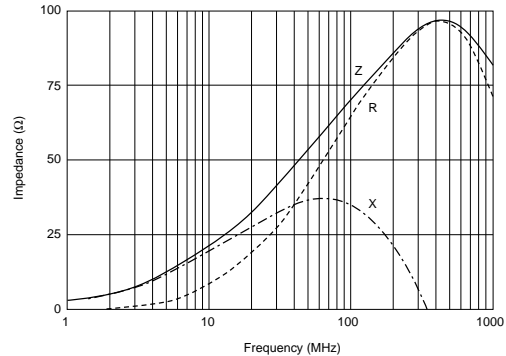

Continued on the following page. ↗

Continued from the preceding page.

Impedance - Frequency Characteristics

BLM41PG181SN1

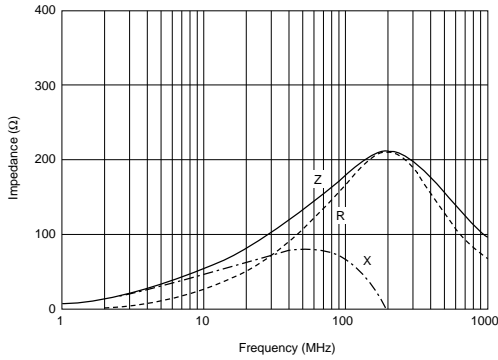

BLM41PG471SN1

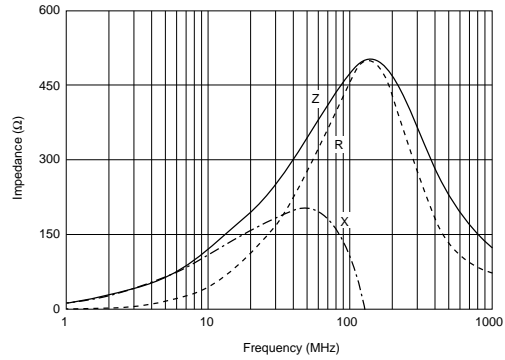

BLM41PG102SN1

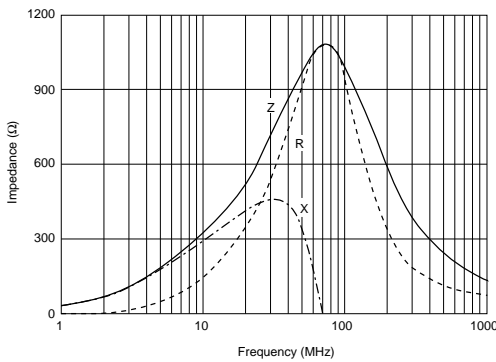

BLM18K Series (0603 Size)

Features

The chip ferrite beads BLM series is designed to function nearly as a resistor at noise frequencies, which greatly reduces the possibility of resonance and leaves signal wave forms undistorted.

BLM series is effective in circuits without stable ground lines because BLM series does not need a connection to ground.

The nickel barrier structure of the external electrodes provides excellent solder heat resistance. BLM_K series can be used in high current circuits due to its low DC resistance. It can match power lines to a maximum of 6A DC.

Equivalent Circuit

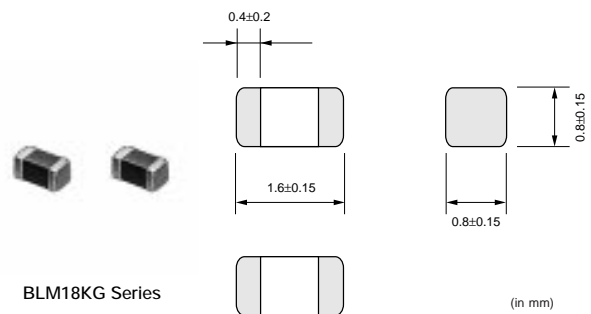
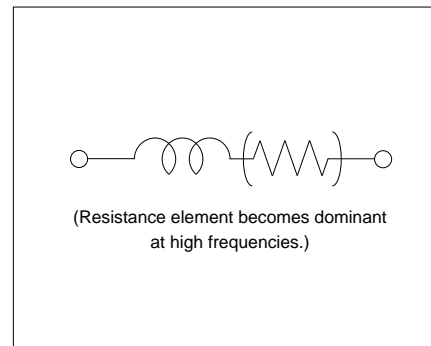

| Part Number | Impedance (at 100MHz/20°C) (ohm) | Rated Current (mA) | DC Resistance (max.) (ohm) | Operating Temperature Range (°C) |
|---------------|--|-----------------------|-------------------------------|--|
| BLM18KG260TN1 | 26 ±25% | 6000 | 0.007 | -55 to +125 |
| BLM18KG700TN1 | 70 ±25% | 3500 | 0.022 | -55 to +125 |
| BLM18KG121TN1 | 120 ±25% | 3000 | 0.030 | -55 to +125 |
| BLM18KG221SN1 | 220 ±25% | 2200 | 0.050 | -55 to +125 |
| BLM18KG331SN1 | 330 ±25% | 1700 | 0.080 | -55 to +125 |
| BLM18KG471SN1 | 470 ±25% | 1500 | 0.130 | -55 to +125 |
| BLM18KG601SN1 | 600 ±25% | 1300 | 0.150 | -55 to +125 |

For the items of rated current higher than 1200mA, derating is required.
Please refer to p.66, "Derating of Rated Current".

1

■ Impedance - Frequency (Typical)

BLM18K Series

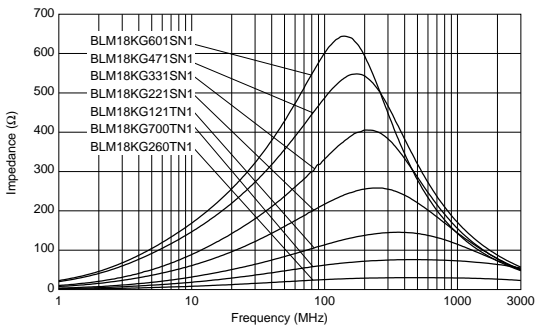

■ Impedance - Frequency Characteristics

BLM18KG260TN1

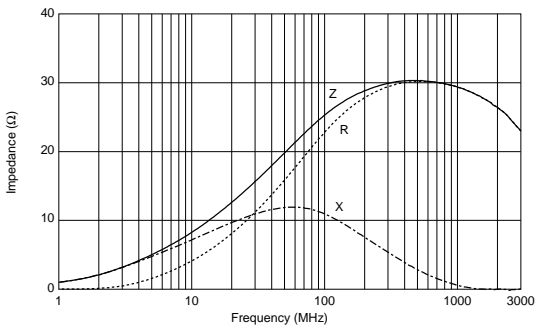

BLM18KG700TN1

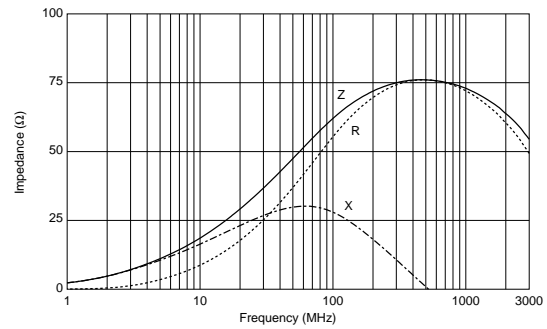

BLM18KG121TN1

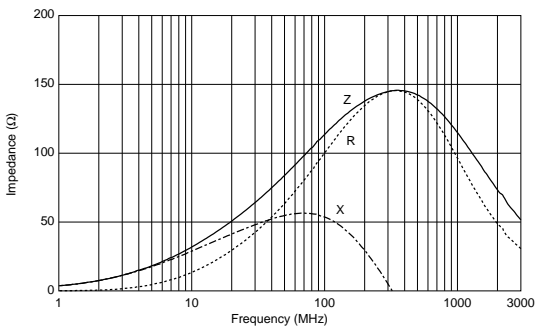

BLM18KG221SN1

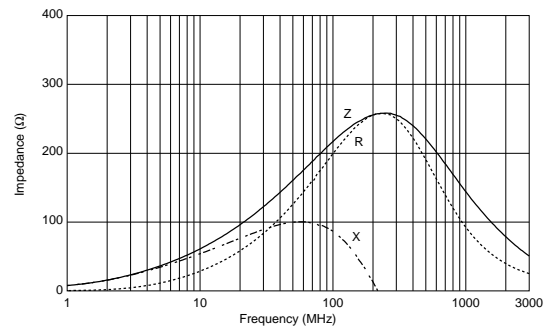

Continued on the following page. ↗

Continued from the preceding page.

Impedance - Frequency Characteristics

BLM18KG331SN1

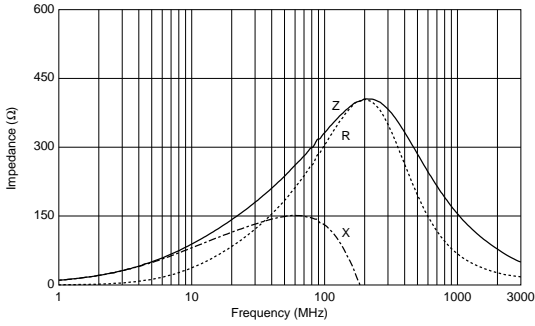

BLM18KG471SN1

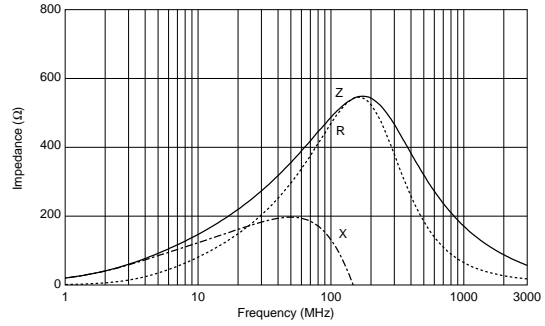

BLM18KG601SN1

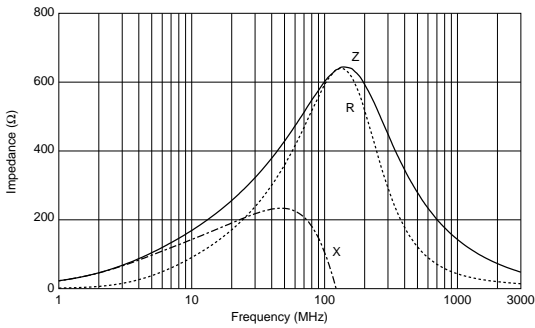

Notice (Rating)

In operating temperatures exceeding +85°C, derating of current is necessary for chip Ferrite Beads for which rated current is 1300mA or over. Please apply the derating curve shown in chart according to the operating temperature.

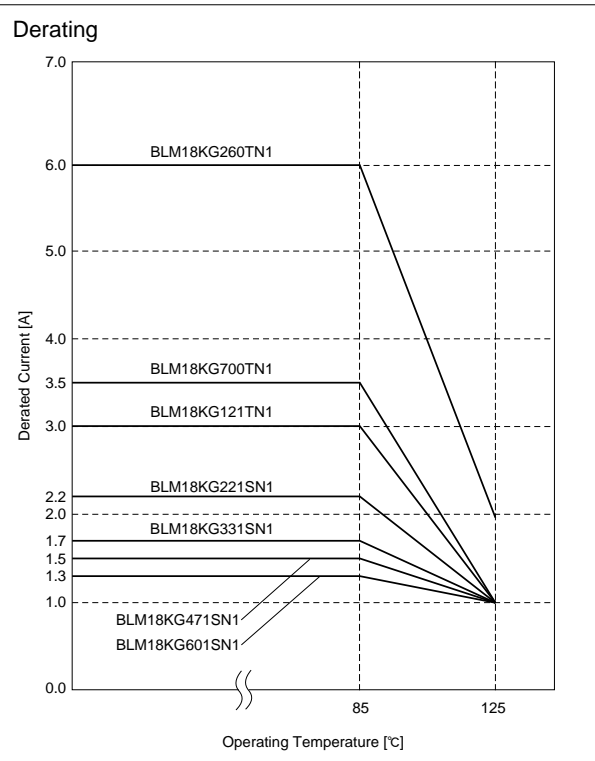

1

BLM18S Series (0603 Size)

■ Features

1. Low DC Resistance/Large Rated Current
2. BLM18S series can be used in high current circuits due to its low DC resistance.
It can match power lines to a maximum of 6A DC.
3. Ni+Sn plating structure of the external electrodes provides excellent solder heat resistance.

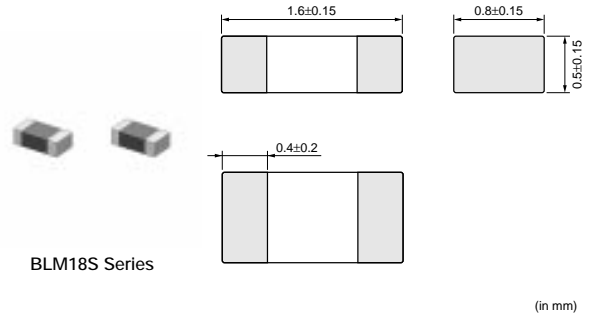

1

■ Applications

EMI suppression for DC power line

| Part Number | Impedance (at 100MHz/20°C) (ohm) | Rated Current (mA) | DC Resistance (max.) (ohm) | Operating Temperature Range (°C) |
|----------------------|----------------------------------|--------------------|----------------------------|----------------------------------|
| BLM18SG260TN1 | 26 ±25% | 6000 | 0.007 | -55 to +125 |
| BLM18SG700TN1 | 70 ±25% | 4000 | 0.020 | -55 to +125 |
| BLM18SG121TN1 | 120 ±25% | 3000 | 0.025 | -55 to +125 |
| BLM18SG221TN1 | 220 ±25% | 2500 | 0.040 | -55 to +125 |
| BLM18SG331TN1 | 330 ±25% | 1500 | 0.070 | -55 to +125 |

For the items of rated current higher than 1500mA, derating is required. Please refer to p.68, "Derating of Rated Current".

■ Impedance - Frequency (Typical)

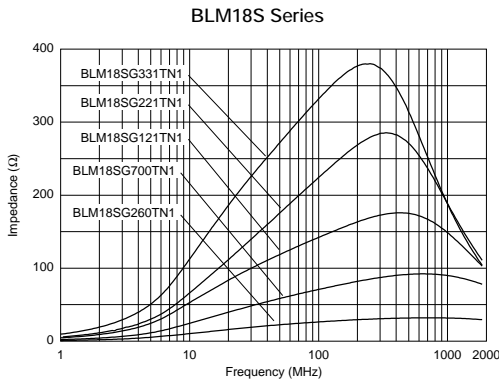

■ Impedance - Frequency Characteristics

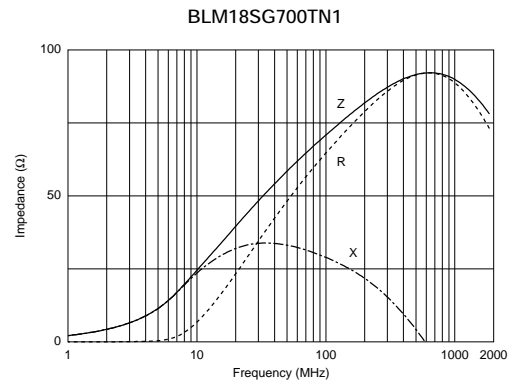
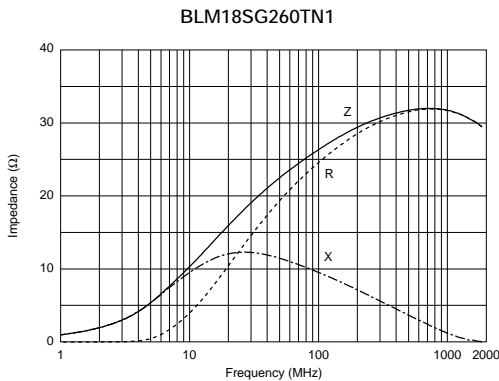

Continued on the following page. ↗

Continued from the preceding page.

■ Impedance - Frequency Characteristics

BLM18SG121TN1

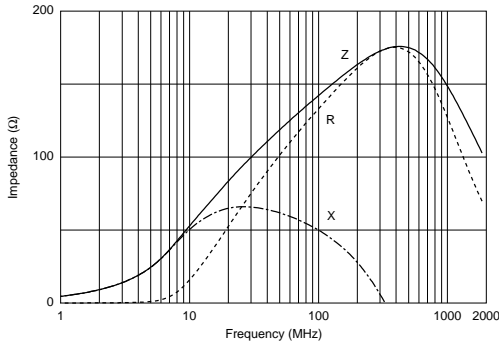

BLM18SG221TN1

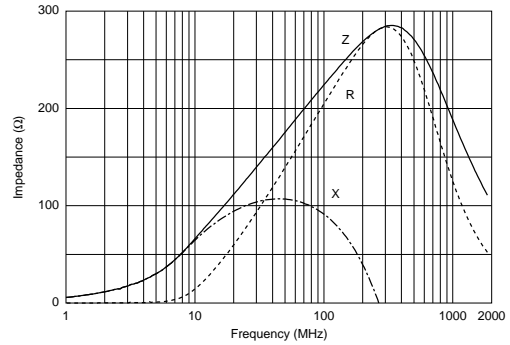

BLM18SG331TN1

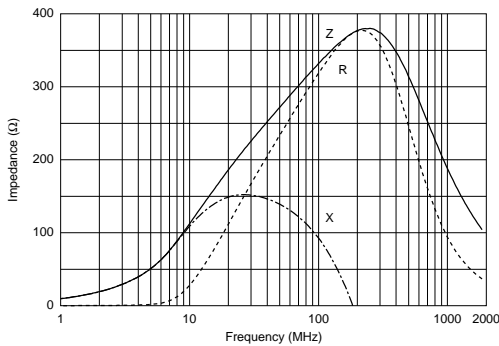

■ Notice (Rating)

In operating temperatures exceeding +85°C, derating of current is necessary for chip Ferrite Beads for which rated current is 1200mA or over. Please apply the derating curve shown in chart according to the operating temperature.

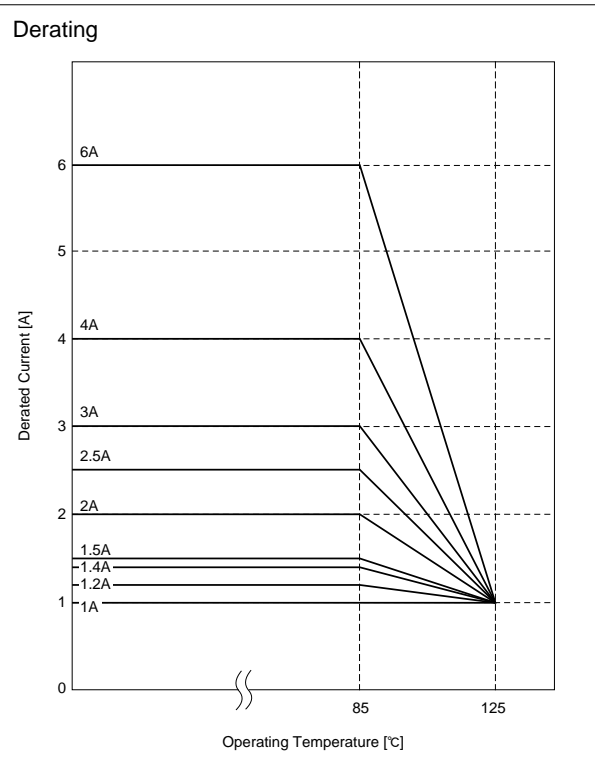

1

On-Board Type (DC) EMI Suppression Filters (EMIFIL®)



GHz Noise Suppression Chip Ferrite Beads BLM15H/15E/18H/18E Series

Excellent high frequency impedance characteristics with 0402 (EIA) size.

Equivalent Circuit

1

Features (BLM15HG/HD/EG Series)

1. Small size: 1.0x0.5mm (0402)
2. Suitable for noise suppression in 1GHz or higher frequency
3. Low DC Resistance/Large Rated Current (BLM15E)
4. No Lead production using Ni+Sn plating in termination

Applications

1. EMI suppression for Note PC and DSC
2. Noise suppression for data line in mobile phone
3. Prevention of erroneous operation caused by local oscillation signal in mobile phone
4. Optical pickup modules

Features (BLM15HB Series)

1. Small size: 1.0x0.5mm
2. Suitable for noise suppression in 1GHz or higher frequency
3. No Lead production using Ni+Sn plating in termination

Applications

1. EMI suppression for Note PC and DSC
2. Noise suppression for data line in mobile phone
3. Noise suppression for USB interface line in mobile phone
4. Prevention of erroneous operation caused by local oscillation signal in mobile phone

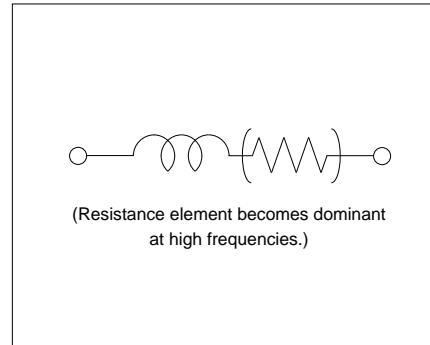

BLM15H Series (0402 Size)

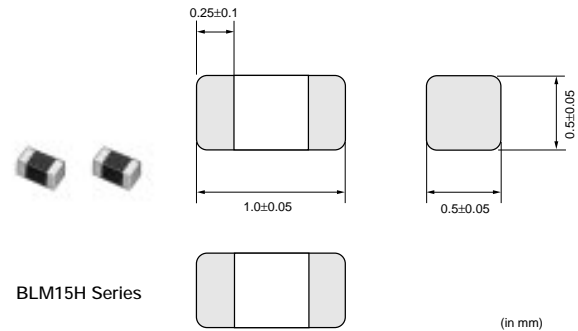

| Part Number | Impedance (at 100MHz/20°C) (ohm) | Impedance (at 1GHz/20°C) (ohm) | Rated Current (mA) | DC Resistance (max.) (ohm) | Operating Temperature Range (°C) |
|----------------------|----------------------------------|--------------------------------|--------------------|----------------------------|----------------------------------|
| BLM15HG601SN1 | 600 ±25% | 1000 ±40% | 300 | 0.7 | -55 to +125 |
| BLM15HG102SN1 | 1000 ±25% | 1400 ±40% | 250 | 1.1 | -55 to +125 |
| BLM15HB121SN1 | 120 ±25% | 500 ±40% | 300 | 0.7 | -55 to +125 |

Continued on the following page.

Continued from the preceding page.

| Part Number | Impedance (at 100MHz/20°C) (ohm) | Impedance (at 1GHz/20°C) (ohm) | Rated Current (mA) | DC Resistance (max.) (ohm) | Operating Temperature Range (°C) |
|----------------------|----------------------------------|--------------------------------|--------------------|----------------------------|----------------------------------|
| BLM15HB221SN1 | 220 ±25% | 900 ±40% | 250 | 1.0 | -55 to +125 |
| BLM15HD601SN1 | 600 ±25% | 1400 ±40% | 300 | 0.85 | -55 to +125 |
| BLM15HD102SN1 | 1000 ±25% | 2000 ±40% | 250 | 1.25 | -55 to +125 |
| BLM15HD182SN1 | 1800 ±25% | 2700 ±40% | 200 | 2.2 | -55 to +125 |

1

■ Impedance - Frequency (Typical)

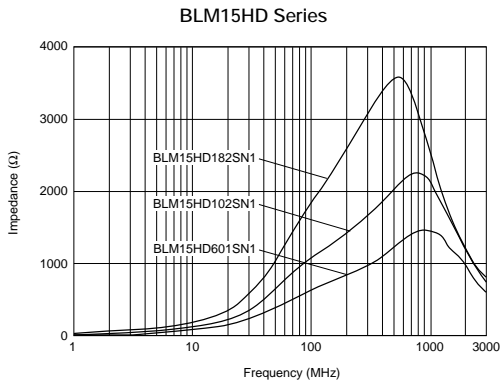
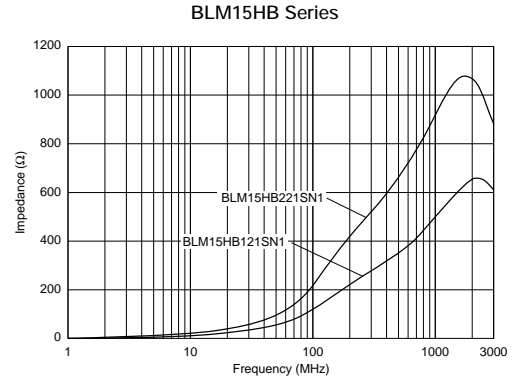
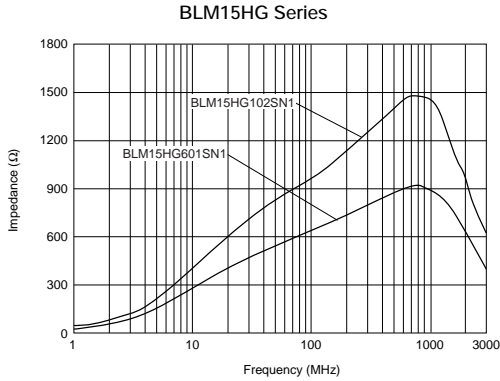

■ Impedance - Frequency Characteristics

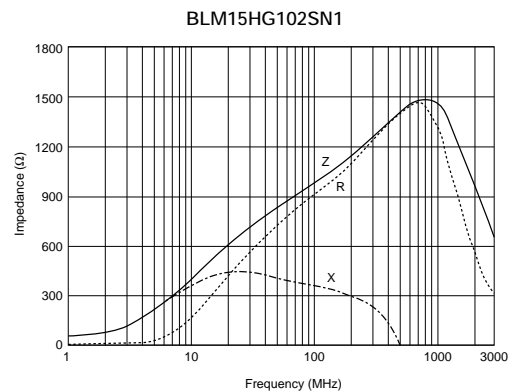
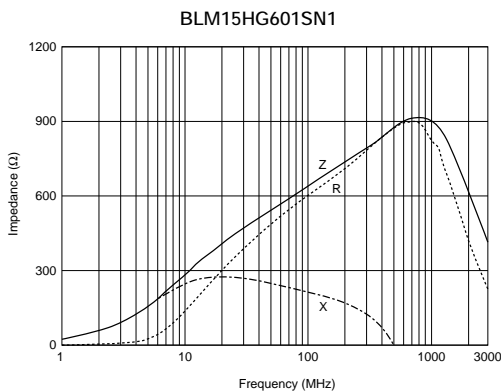

Continued on the following page. ↗

Continued from the preceding page.

Impedance - Frequency Characteristics

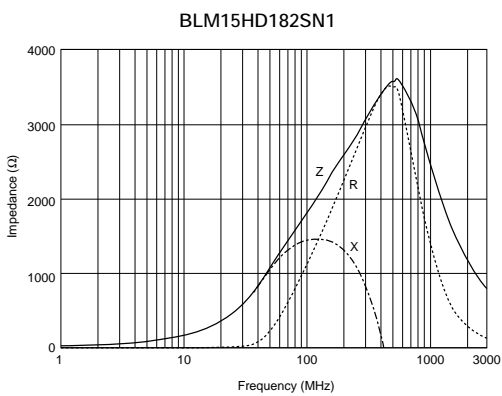
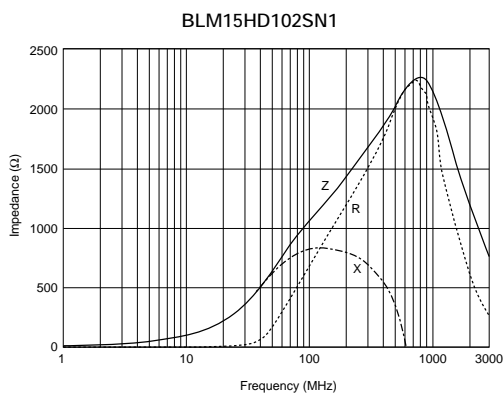
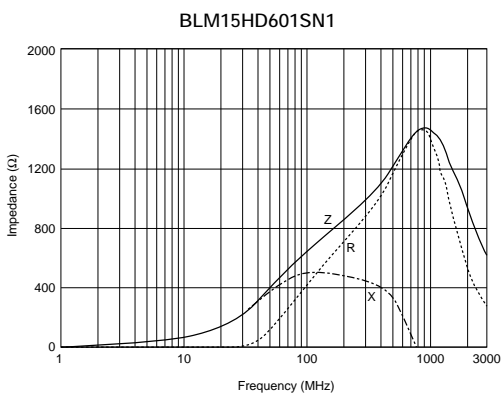
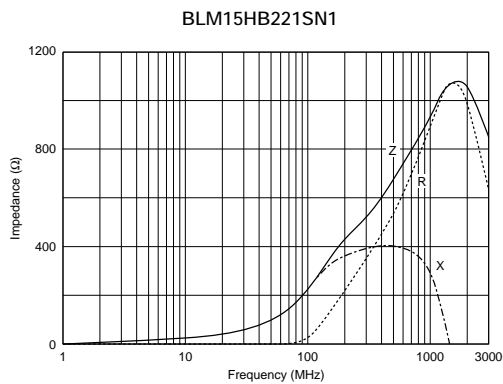
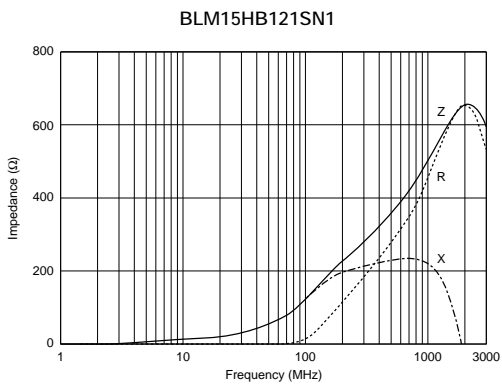

1

BLM15E Series (0402 Size)

1



| Part Number | Impedance (at 100MHz/20°C) (ohm) | Impedance (at 1GHz/20°C) (ohm) | Rated Current (mA) | DC Resistance (max.) (ohm) | Operating Temperature Range (°C) |
|----------------------|----------------------------------|--------------------------------|--------------------|----------------------------|----------------------------------|
| BLM15EG121SN1 | 120 ±25% | 145 (Typ.) | 1500 | 0.095 | -55 to +125 |
| BLM15EG221SN1 | 220 ±25% | 270 (Typ.) | 700 | 0.28 | -55 to +125 |

In operating temperature exceeding +85°C, derating of current is necessary for BLM15E series.
Please refer to p.73, "Derating of Rated Current".

■ Impedance - Frequency (Typical)

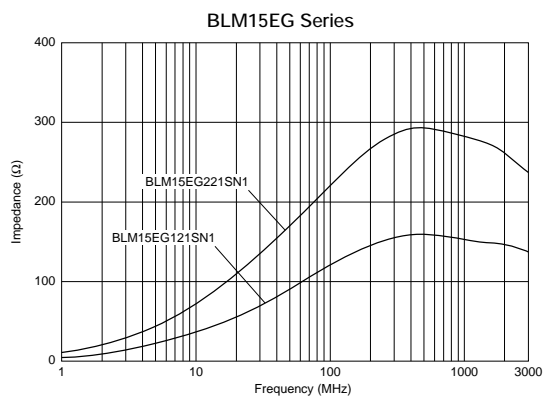

■ Impedance - Frequency Characteristics

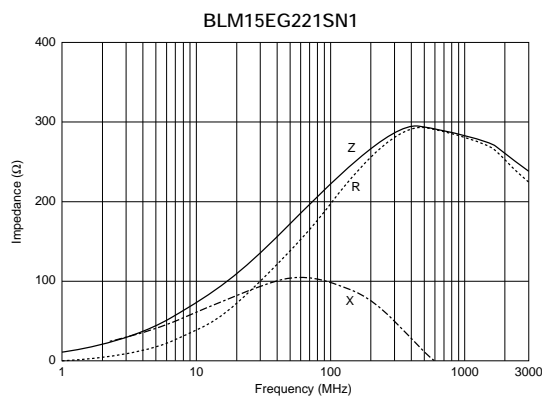
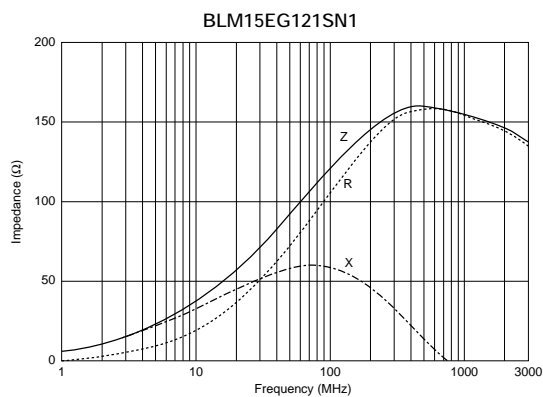

Continued on the following page. ↗

Continued from the preceding page.

■ Notice (Rating)

In operating temperature exceeding +85°C, derating of current is necessary for BLM15E series.

Please apply the derating curve shown in chart according to the operating temperature.

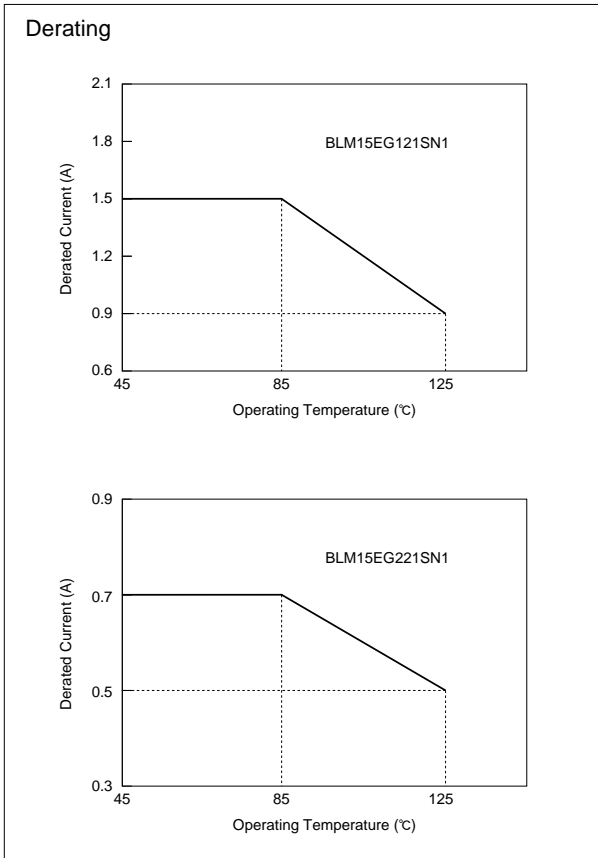

1

BLM18H/BLM18E series has a modified internal electrode structure, that minimizes stray capacitance and increases the effective frequency range.

Equivalent Circuit

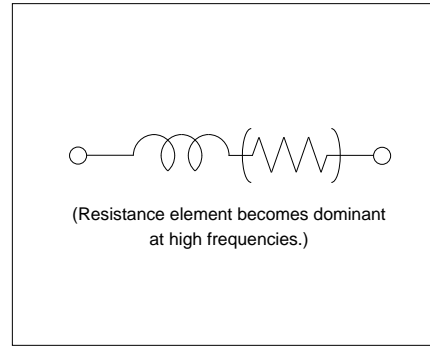

1

Features (BLM18H series)

1. BLM18H series realizes high impedance at 1GHz and is suitable for noise suppression from 500MHz to GHz range. The impedance value of HG/HD-type is about three times as large as that of A/B-type at 1GHz, though the impedance characteristic of HG/HD-type is similar to A/B-type at 100MHz or less.
2. HG-type is effective in noise suppression in wide frequency range (several MHz to several GHz). HB/HD-type for high-speed signal line provides a sharper roll-off after the cut-off frequency. HK-type for digital interface and HE-type for optical pickup modules are effective in suppressing the ringing because resistance especially grows in the lower frequency.
3. The magnetic shielded structure minimizes crosstalk.

Features (BLM18E series)

1. Low DC Resistance and a large Rated Current are suitable for noise suppression of the driver circuit.
2. Excellent direct current characteristics
3. Thin type (t=0.5mm) is suitable for small and low profile equipment such as DSC, cellular phones.

BLM18H Series (0603 Size)

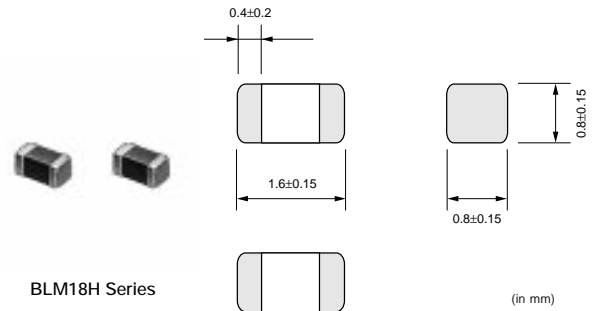

| Part Number | Impedance (at 100MHz/20°C) (ohm) | Impedance (at 1GHz/20°C) (ohm) | Rated Current (mA) | DC Resistance (max.) (ohm) | Operating Temperature Range (°C) |
|---------------|----------------------------------|--------------------------------|--------------------|----------------------------|----------------------------------|
| BLM18HG471SN1 | 470 ±25% | 600 (Typ.) | 200 | 0.85 | -55 to +125 |
| BLM18HG601SN1 | 600 ±25% | 700 (Typ.) | 200 | 1.00 | -55 to +125 |
| BLM18HG102SN1 | 1000 ±25% | 1000 (Typ.) | 100 | 1.60 | -55 to +125 |
| BLM18HB121SN1 | 120 ±25% | 500 ±40% | 200 | 0.50 | -55 to +125 |
| BLM18HB221SN1 | 220 ±25% | 1100 ±40% | 100 | 0.80 | -55 to +125 |
| BLM18HB331SN1 | 330 ±25% | 1600 ±40% | 50 | 1.20 | -55 to +125 |
| BLM18HD471SN1 | 470 ±25% | 1000 (Typ.) | 100 | 1.20 | -55 to +125 |
| BLM18HD601SN1 | 600 ±25% | 1200 (Typ.) | 100 | 1.50 | -55 to +125 |
| BLM18HD102SN1 | 1000 ±25% | 1700 (Typ.) | 50 | 1.80 | -55 to +125 |
| BLM18HE601SN1 | 600 ±25% | 600 (Typ.) | 800 | 0.25 | -55 to +125 |
| BLM18HE102SN1 | 1000 ±25% | 1000 (Typ.) | 600 | 0.35 | -55 to +125 |
| BLM18HE152SN1 | 1500 ±25% | 1500 (Typ.) | 500 | 0.50 | -55 to +125 |
| BLM18HK331SN1 | 330 ±25% | 400 ±40% | 200 | 0.50 | -55 to +125 |
| BLM18HK471SN1 | 470 ±25% | 600 ±40% | 200 | 0.70 | -55 to +125 |

Continued on the following page.

Continued from the preceding page.

| Part Number | Impedance (at 100MHz/20°C) (ohm) | Impedance (at 1GHz/20°C) (ohm) | Rated Current (mA) | DC Resistance (max.) (ohm) | Operating Temperature Range (°C) |
|----------------------|----------------------------------|--------------------------------|--------------------|----------------------------|----------------------------------|
| BLM18HK601SN1 | 600 ±25% | 700 ±40% | 100 | 0.90 | -55 to +125 |
| BLM18HK102SN1 | 1000 ±25% | 1200 ±40% | 50 | 1.50 | -55 to +125 |

In operating temperature exceeding +85°C, derating of current is necessary for BLM18HE series.
 Please refer to p.78, "Derating of Rated Current".

■ Impedance - Frequency (Typical)

1

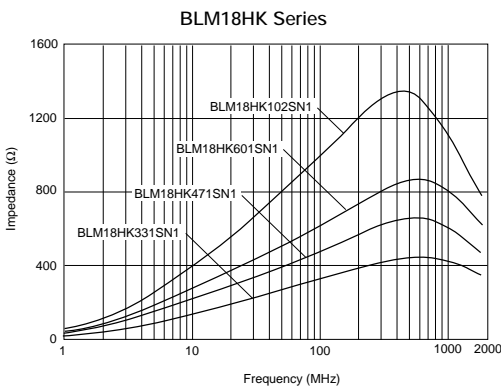
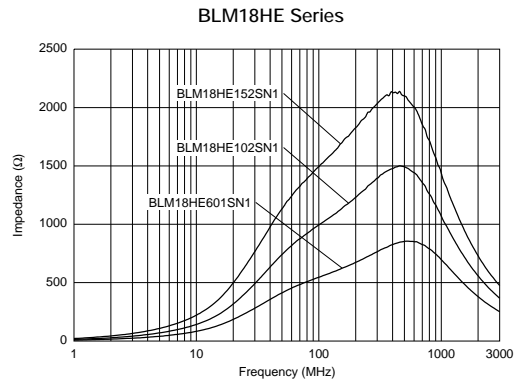
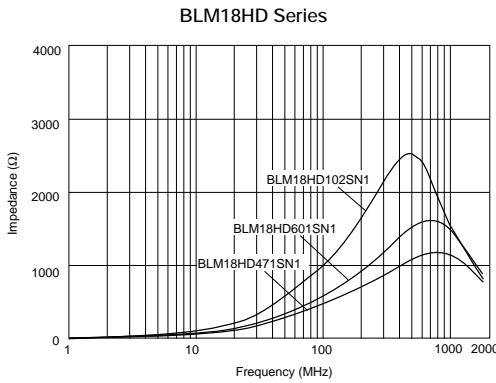
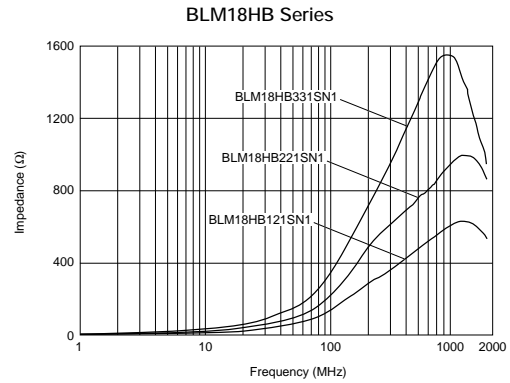
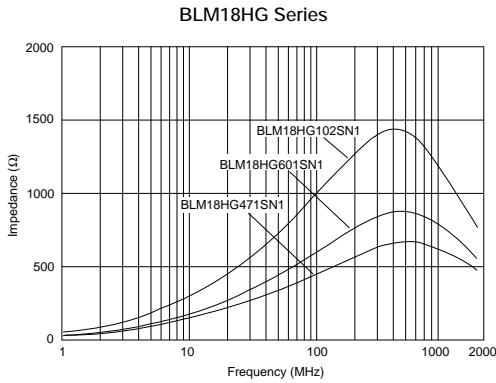

■ Impedance - Frequency Characteristics

BLM18HG471SN1

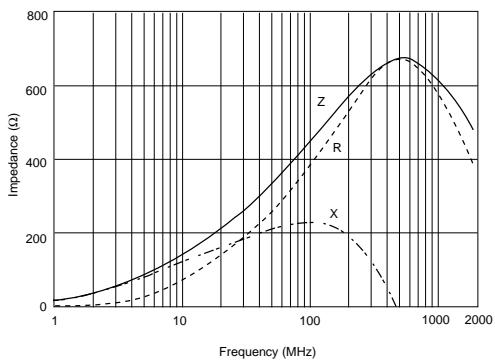

BLM18HG601SN1

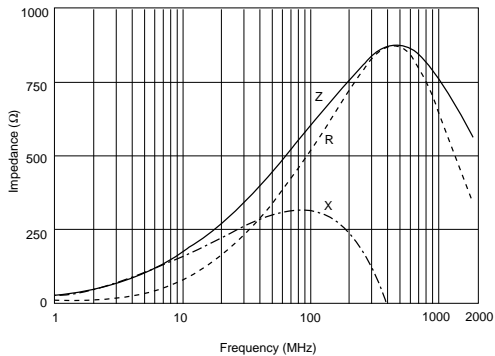

BLM18HG102SN1

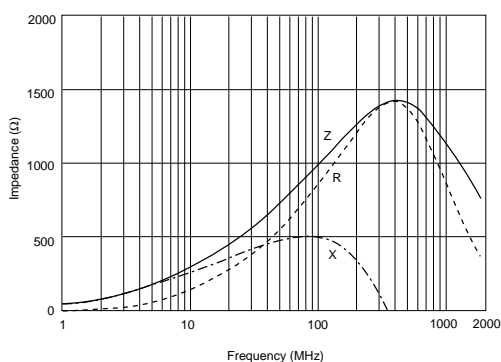

BLM18HB121SN1

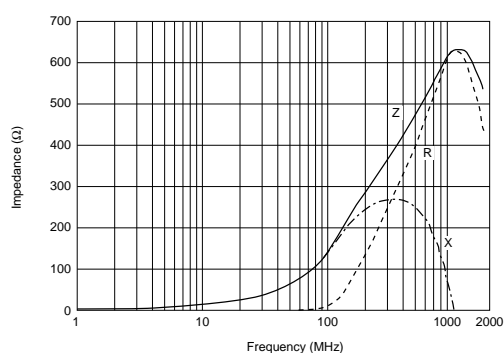

BLM18HB221SN1

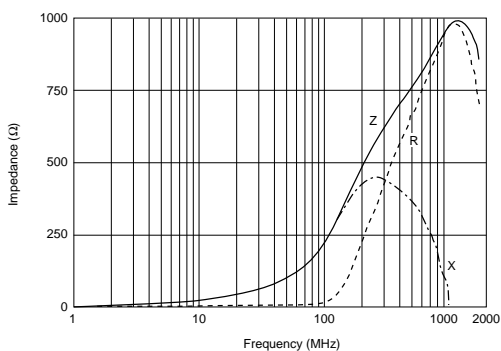

BLM18HB331SN1

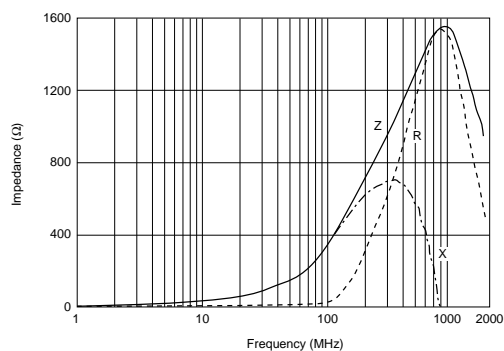

BLM18HD471SN1

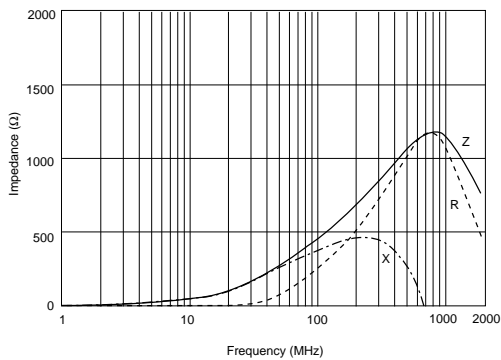

BLM18HD601SN1

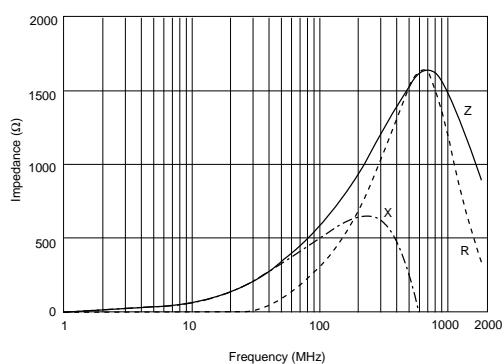

1

Continued from the preceding page.

Impedance - Frequency Characteristics

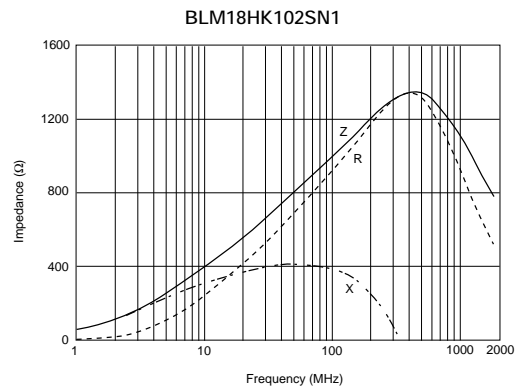
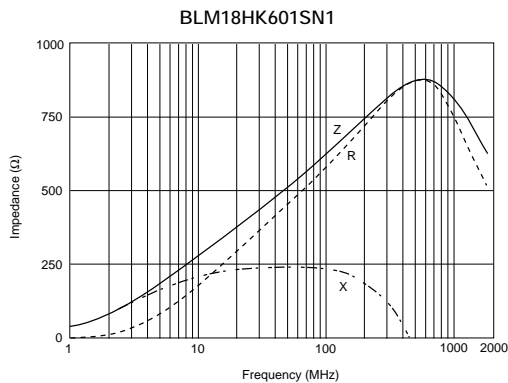
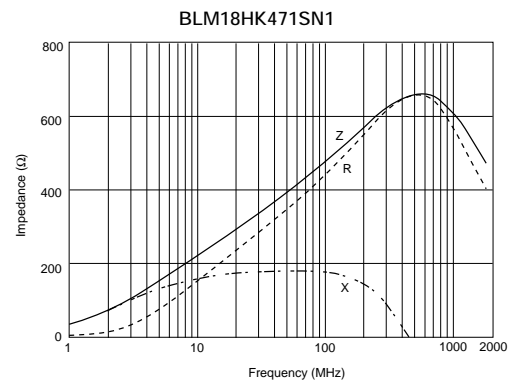
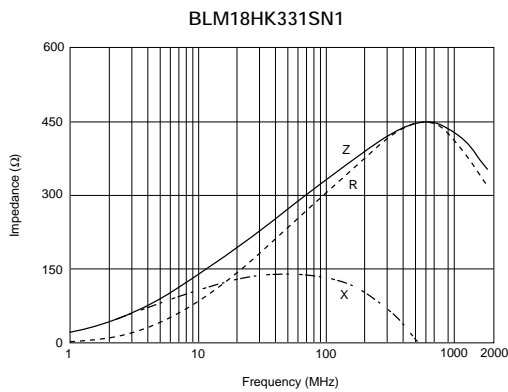
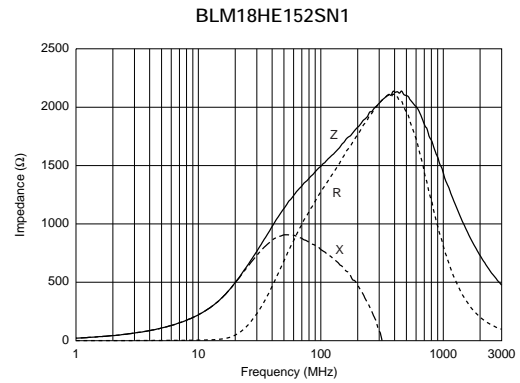
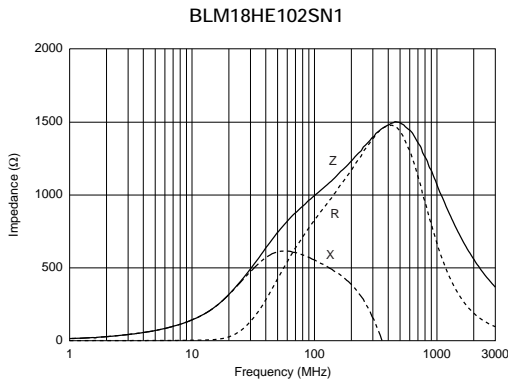
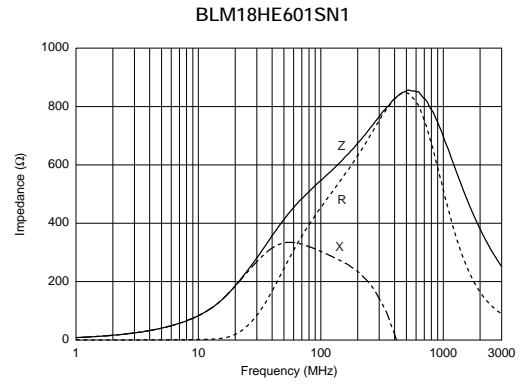
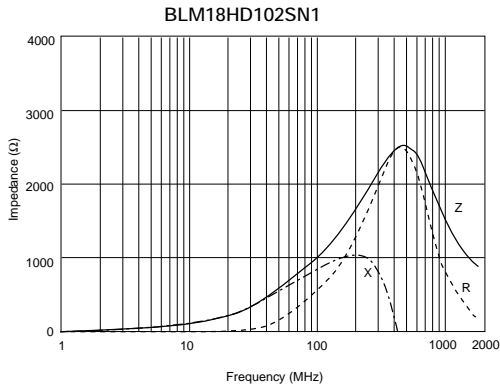

1

Continued on the following page. ↗

Continued from the preceding page.

Notice (Rating)

In operating temperature exceeding +85°C, derating of current is necessary for BLM18HE series.
 Please apply the derating curve shown in chart according to the operating temperature.

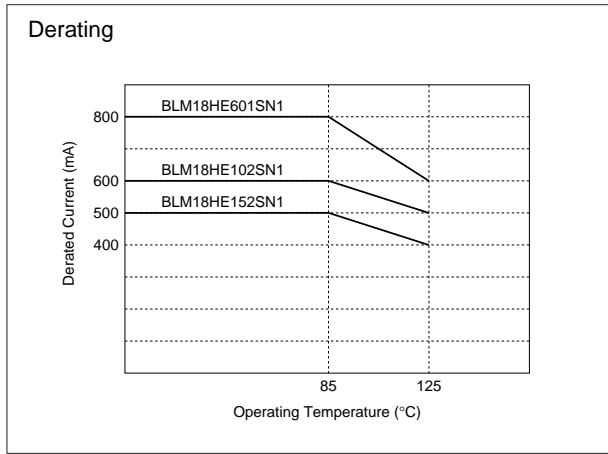

1

BLM18E Series (0603 Size)

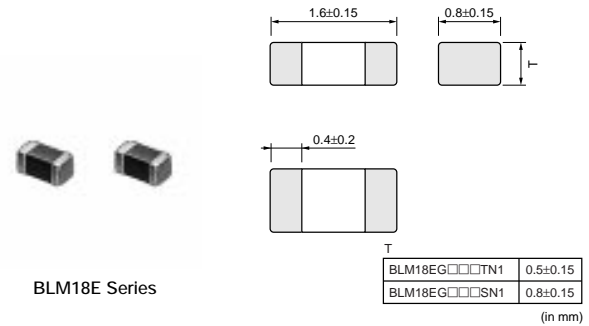

| Part Number | Impedance (at 100MHz/20°C) (ohm) | Impedance (at 1GHz/20°C) (ohm) | Rated Current (mA) | DC Resistance (max.) (ohm) | Operating Temperature Range (°C) |
|---------------|----------------------------------|--------------------------------|--------------------|----------------------------|----------------------------------|
| BLM18EG101TN1 | 100 ±25% | 140 (Typ.) | 2000 | 0.045 | -55 to +125 |
| BLM18EG121SN1 | 120 ±25% | 145 (Typ.) | 2000 | 0.04 | -55 to +125 |
| BLM18EG221SN1 | 220 ±25% | 260 (Typ.) | 2000 | 0.05 | -55 to +125 |
| BLM18EG221TN1 | 220 ±25% | 300 (Typ.) | 1000 | 0.15 | -55 to +125 |
| BLM18EG331TN1 | 330 ±25% | 450 (Typ.) | 500 | 0.21 | -55 to +125 |
| BLM18EG391TN1 | 390 ±25% | 520 (Typ.) | 500 | 0.3 | -55 to +125 |
| BLM18EG471SN1 | 470 ±25% | 550 (Typ.) | 500 | 0.21 | -55 to +125 |
| BLM18EG601SN1 | 600 ±25% | 700 (Typ.) | 500 | 0.35 | -55 to +125 |

For the items of rated current higher than 2000mA, derating is required.
 Please refer to p.80, "Derating of Rated Current".

Impedance - Frequency (Typical)

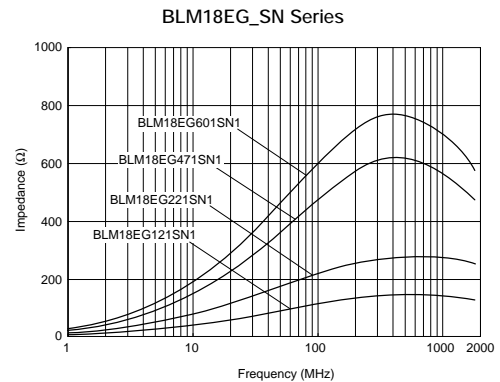
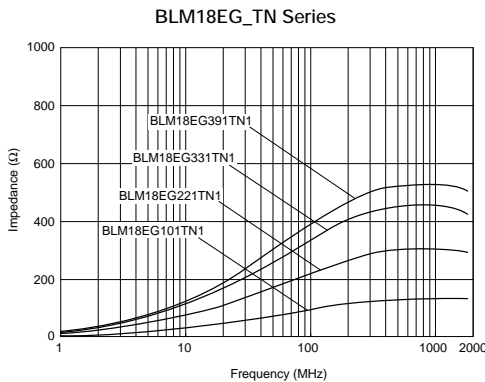

■ Impedance - Frequency Characteristics

BLM18EG101TN1

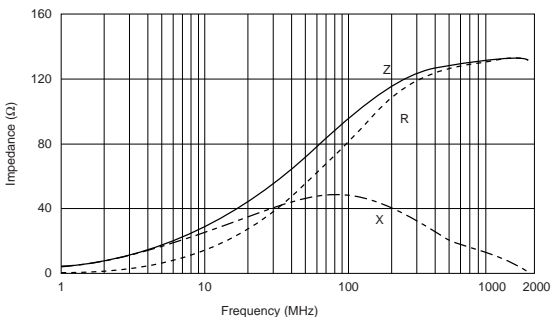

BLM18EG121SN1

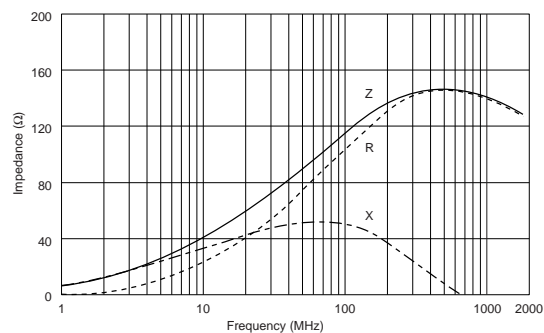

BLM18EG221SN1

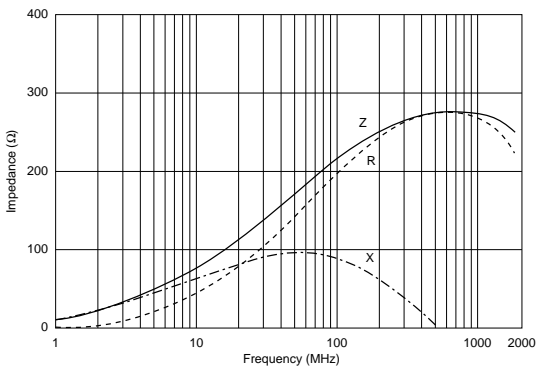

BLM18EG221TN1

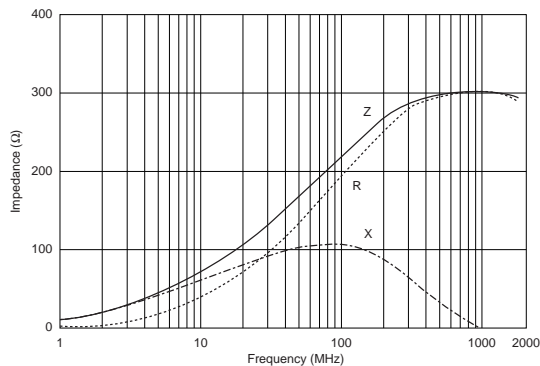

BLM18EG331TN1

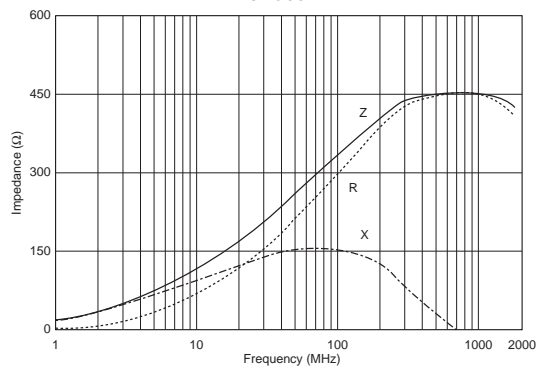

BLM18EG391TN1

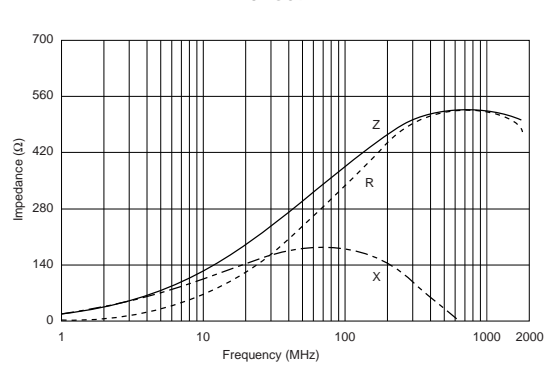

BLM18EG471SN1

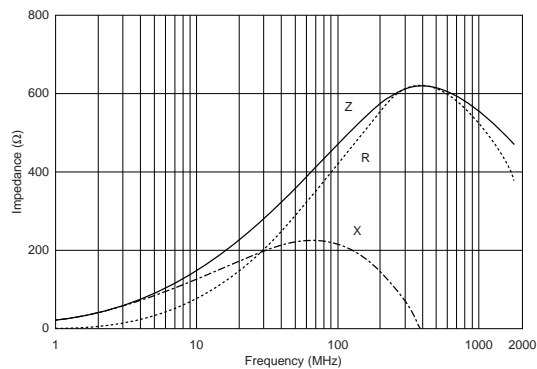

BLM18EG601SN1

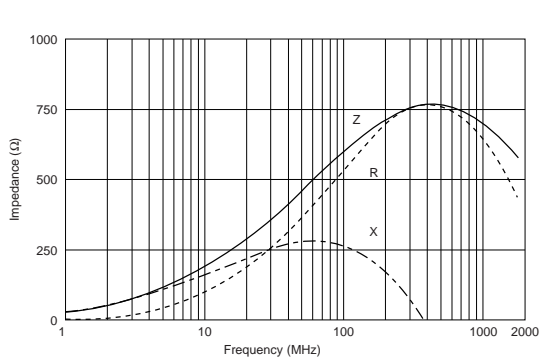

1

Continued on the following page.

☒ Continued from the preceding page.

■ Notice (Rating)

In operating temperatures exceeding +85°C, derating of current is necessary for chip Ferrite Beads for which rated current is 1200mA or over. Please apply the derating curve shown in chart according to the operating temperature.

1

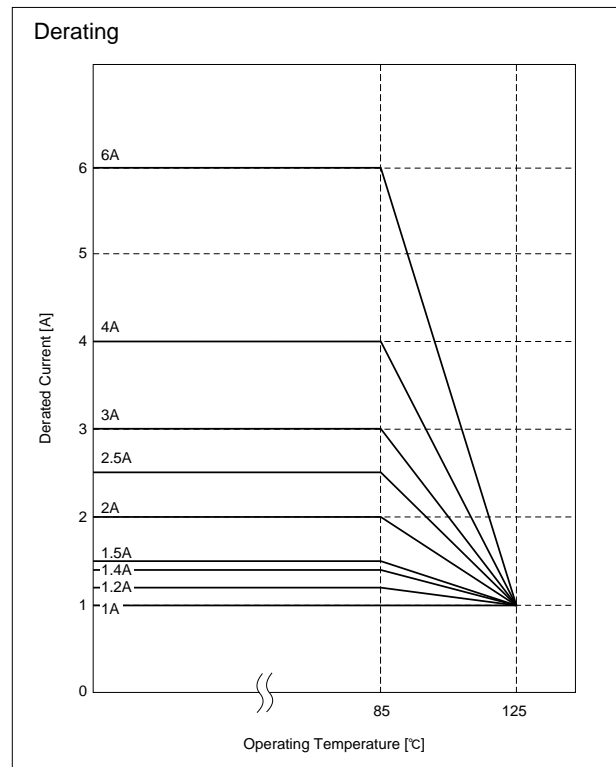

On-Board Type (DC) EMI Suppression Filters (EMIFIL®)



High-GHz Noise Suppression Chip Ferrite Beads BLM15G/18G Series

Chip ferrite beads for high frequency noise suppression over a wide frequency range.

■ Equivalent Circuit

1

■ Features

1. High impedance characteristic in 1GHz or higher frequency
2. High impedance characteristic over a wide frequency band range of 100MHz to 6GHz
3. Small decrease in impedance during current loading, resulting in small impedance fluctuation during equipment operation.
4. Reflow soldering only

■ Applications

1. Noise suppression for PCs with high-speed CPU and high-speed bus, and for interface lines of peripheral equipment.
2. High harmonic noise suppression for digital equipment with several hundred MHz or higher clock speeds.
3. Prevention of erroneous operation caused by local oscillation signals in mobile phone and W-LAN module (ensuring self-immunity).
4. Bias Tee modules in optical transceivers

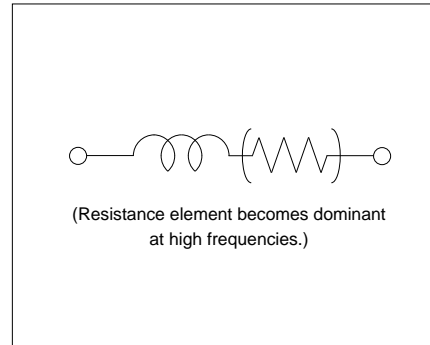

BLM15G Series (0402 Size)

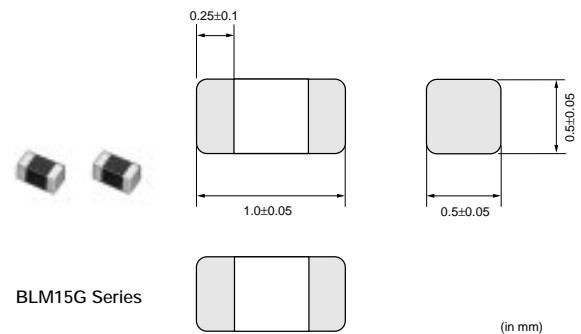

| Part Number | Impedance (at 100MHz/20°C) (ohm) | Impedance (at 1GHz/20°C) (ohm) | Rated Current (mA) | DC Resistance (max.) (ohm) | Operating Temperature Range (°C) |
|----------------------|----------------------------------|--------------------------------|--------------------|----------------------------|----------------------------------|
| BLM15GG221SN1 | 220 ±25% | 600 ±40% | 300 | 0.7 | -55 to +125 |
| BLM15GG471SN1 | 470 ±25% | 1200 ±40% | 200 | 1.3 | -55 to +125 |
| BLM15GA750SN1 | 75 ±25% | 1000 ±40% | 200 | 1.3 | -55 to +125 |

■ Impedance - Frequency (Typical)

BLM15G Series

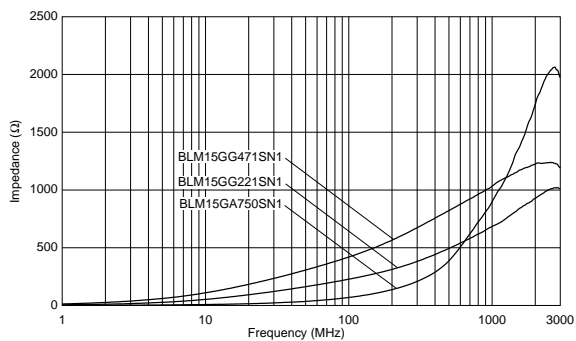

■ Impedance - Frequency Characteristics

BLM15GG221SN1

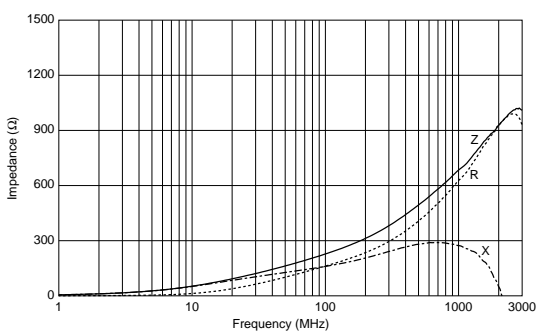

BLM15GG471SN1

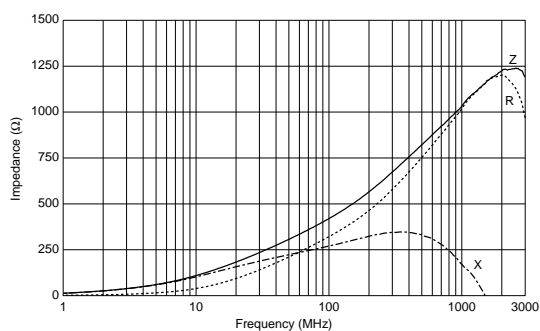

BLM15GA750SN1

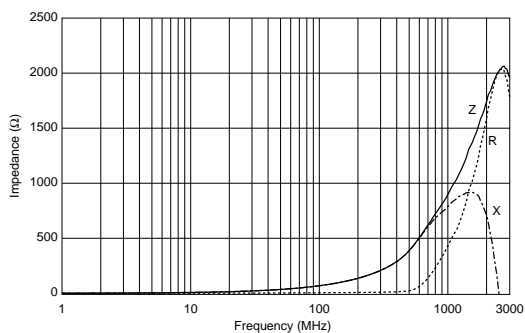

BLM18G Series (0603 Size)

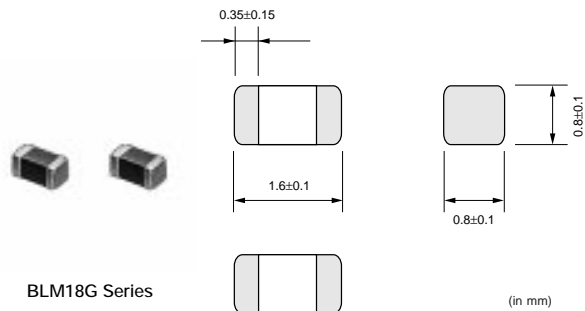

1

| Part Number | Impedance (at 100MHz/20°C) (ohm) | Impedance (at 1GHz/20°C) (ohm) | Rated Current (mA) | DC Resistance (max.) (ohm) | Operating Temperature Range (°C) |
|----------------------|--|--------------------------------------|-----------------------|-------------------------------|--|
| BLM18GG471SN1 | 470 ±25% | 1800 ±30% | 200 | 1.30 | -55 to +125 |

■ Impedance - Frequency (Typical)

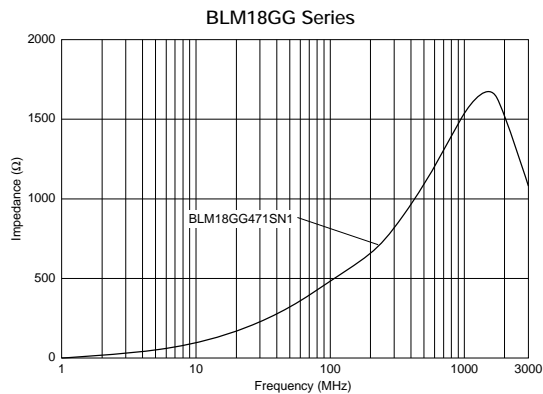

■ Impedance - Frequency Characteristics

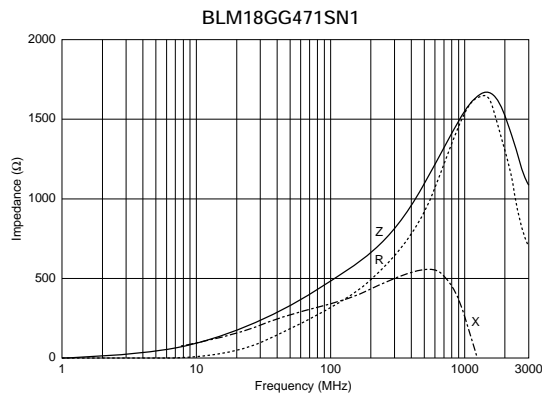

Noise Suppression Effect

Noise Suppression in UHF Range

1

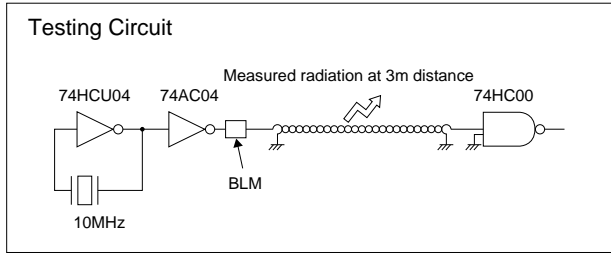

| Type of Filter | EMI Suppression Effect | Description |
|--|------------------------|---|
| Initial (No filter) | | |
| Conventional Type BLM18AG102SN1 (1000Ω at 100MHz) | | Current BLM are effective in suppressing noise in the range between 300MHz and 700MHz. |
| for GHz Noise Suppression BLM18HG102SN1 (1000Ω at 100MHz) | | In addition to the effectiveness of current BLM, BLM18HG suppresses noise in the range beyond 700MHz. |

Comparison between BLM18HG102SN1 and BLM18AG102SN1 (Current Item)

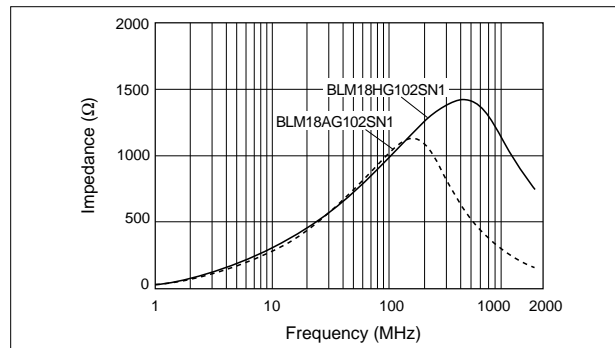

On-Board Type (DC) EMI Suppression Filters (EMIFIL®)



Chip Ferrite Beads Arrays BLA2AA/2AB/31A/31B Series

BLA2AA/BLA2AB Series

■ Features

1. BLA2AA/2AB series has 4 circuits in 2.0x1.0mm body with 0.5mm pitch.
2. Provides attenuation across a broad frequency range.
Two types of impedance characteristics are available, one is for general signal line and the other is for high speed signal line.
3. Original inner electrode structure enables extra low crosstalk.
4. The nickel barrier structure of the external electrodes provides excellent solder heat resistance.

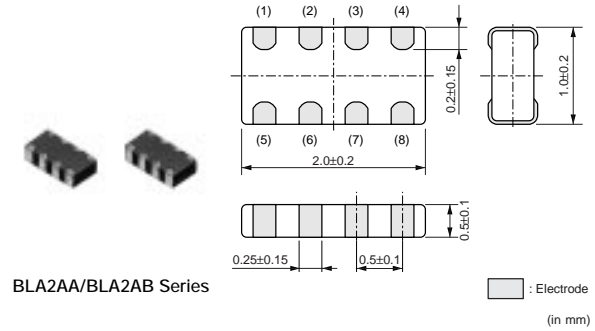

■ Applications

Notebook size PCs, PDAs and other compact size digital equipment

| Part Number | Impedance (at 100MHz/20°C) (ohm) | Rated Current (mA) | DC Resistance (max.) (ohm) | Operating Temperature Range (°C) |
|---------------|----------------------------------|--------------------|----------------------------|----------------------------------|
| BLA2AAG121SN4 | 120 ±25% | 100 | 0.50 | -55 to +125 |
| BLA2AAG221SN4 | 220 ±25% | 50 | 0.70 | -55 to +125 |
| BLA2AAG601SN4 | 600 ±25% | 50 | 1.10 | -55 to +125 |
| BLA2AAG102SN4 | 1000 ±25% | 50 | 1.30 | -55 to +125 |
| BLA2ABB100SN4 | 10 ±25% | 200 | 0.1 | -55 to +125 |
| BLA2ABB220SN4 | 22 ±25% | 200 | 0.2 | -55 to +125 |
| BLA2ABB470SN4 | 47 ±25% | 200 | 0.35 | -55 to +125 |
| BLA2ABB121SN4 | 120 ±25% | 50 | 0.60 | -55 to +125 |
| BLA2ABB221SN4 | 220 ±25% | 50 | 0.90 | -55 to +125 |
| BLA2ABD750SN4 | 75 ±25% | 200 | 0.20 | -55 to +125 |
| BLA2ABD121SN4 | 120 ±25% | 200 | 0.35 | -55 to +125 |
| BLA2ABD221SN4 | 220 ±25% | 100 | 0.40 | -55 to +125 |
| BLA2ABD471SN4 | 470 ±25% | 100 | 0.65 | -55 to +125 |
| BLA2ABD601SN4 | 600 ±25% | 100 | 0.80 | -55 to +125 |
| BLA2ABD102SN4 | 1000 ±25% | 50 | 1.00 | -55 to +125 |

Number of Circuits: 4

1

Equivalent Circuit

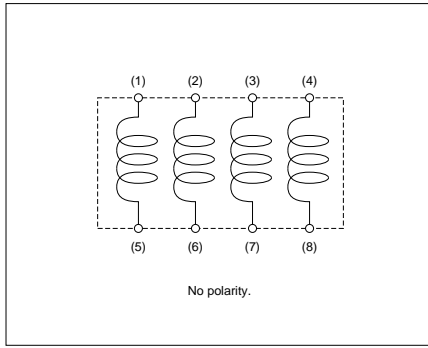

Impedance - Frequency (Typical)

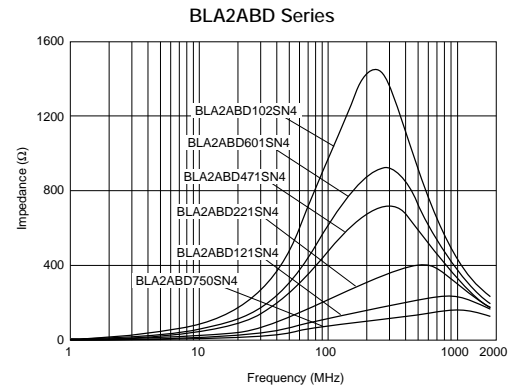
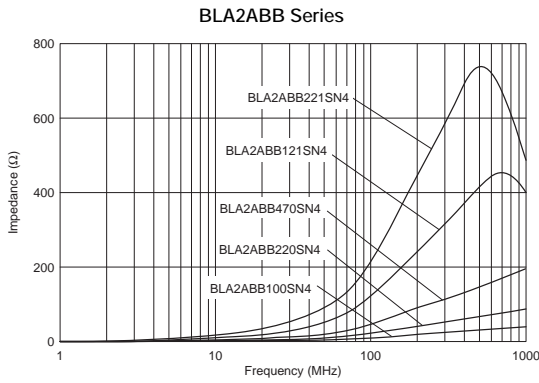
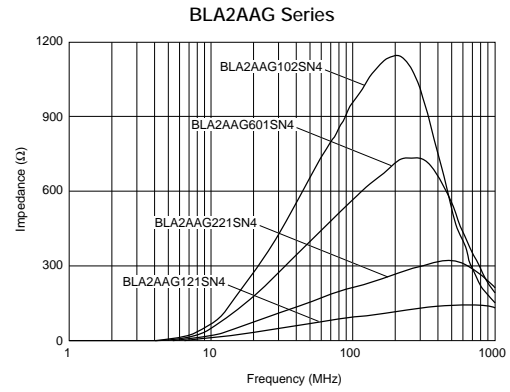

Impedance - Frequency Characteristics

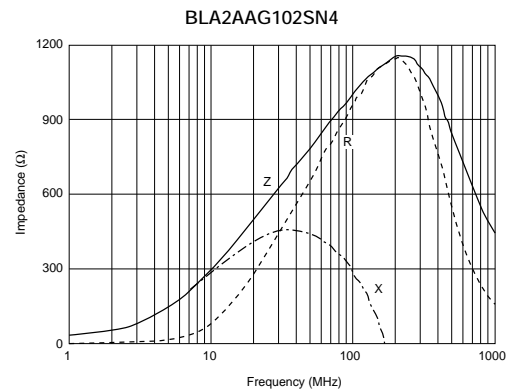
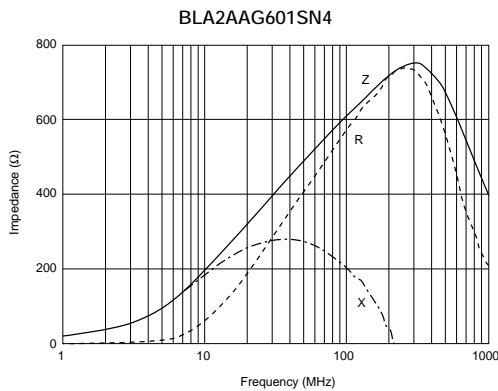
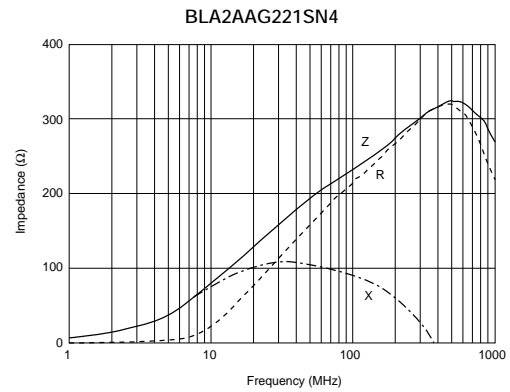
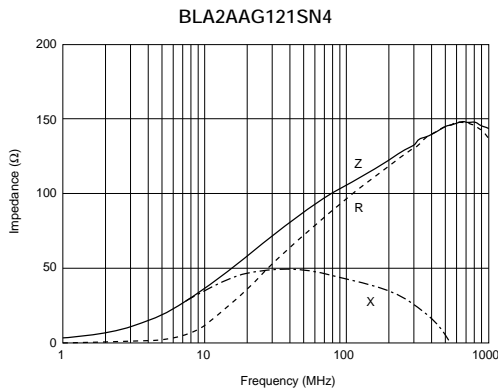

Continued on the following page. ↗

Continued from the preceding page.

Impedance - Frequency Characteristics

BLA2ABB100SN4

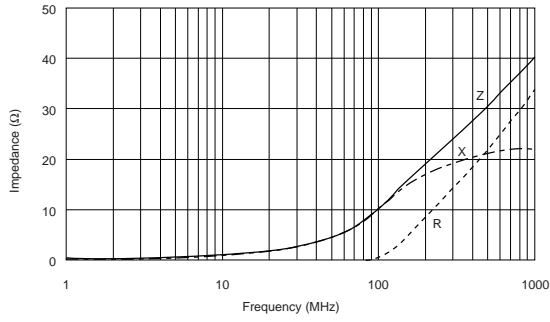

BLA2ABB220SN4

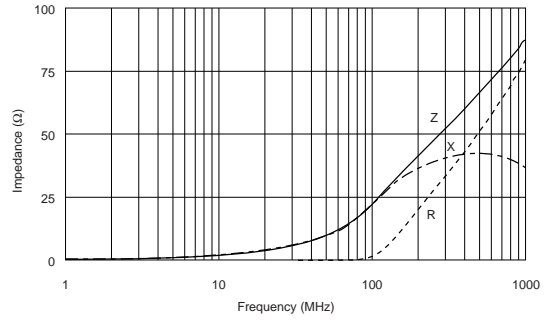

BLA2ABB470SN4

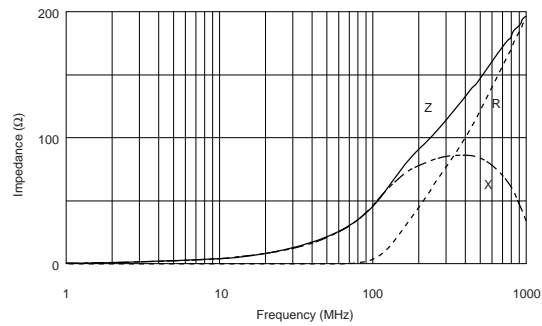

BLA2ABB121SN4

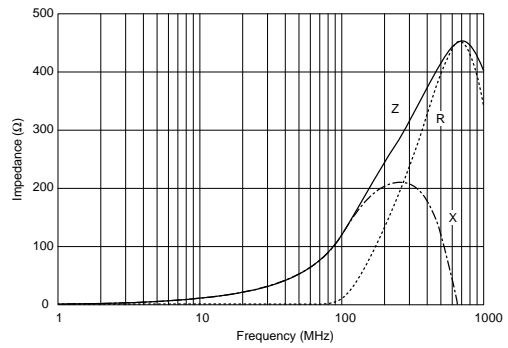

BLA2ABB221SN4

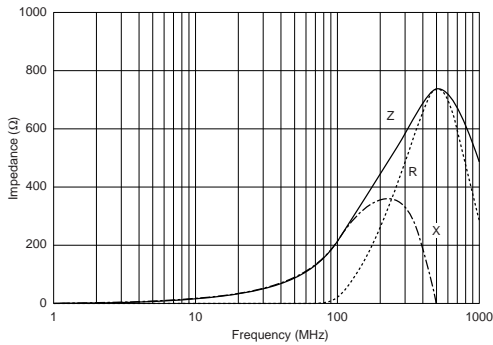

BLA2ABD750SN4

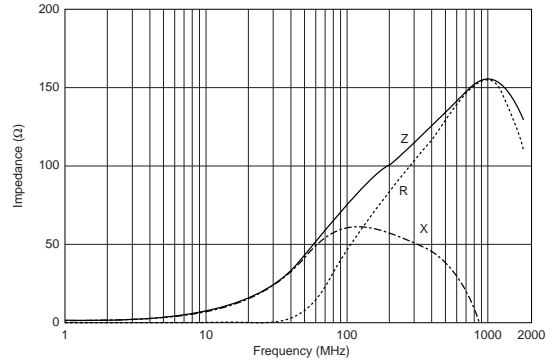

BLA2ABD121SN4

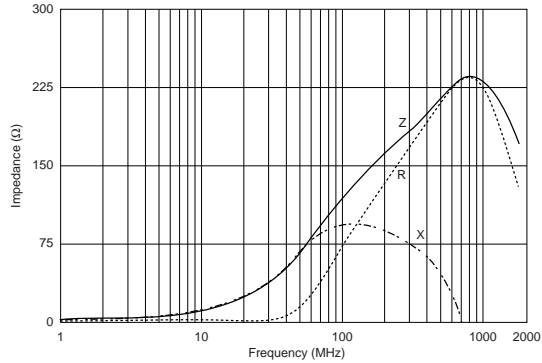

BLA2ABD221SN4

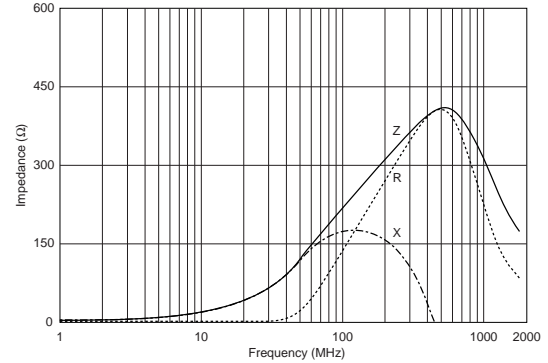

Continued on the following page. ↗

1

Continued from the preceding page.

Impedance - Frequency Characteristics

BLA2ABD471SN4

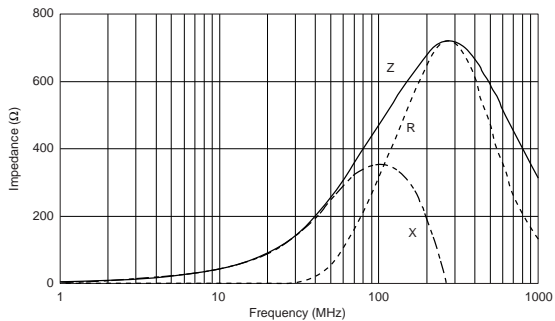

BLA2ABD601SN4

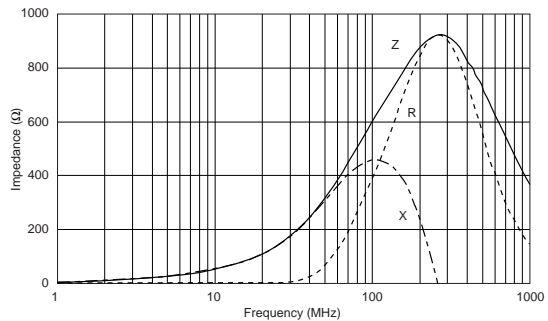

BLA2ABD102SN4

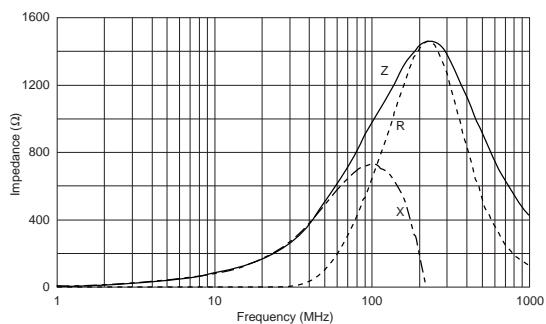

1

BLA31A/BLA31B Series

The miniaturization of electronic equipment requires high performance EMI filters which enable high density mounting. BLA31A/B series consists of 4 circuits of ferrite beads.

BLA31A/B is suitable for EMI suppression in smaller digital equipment.

■ Features

1. BLA31A/B has 4 circuits in 3.2x1.6mm body with 0.8mm pitch.
2. Provides attenuation across a broad frequency range.
Two types of impedance are available which meet general signal line and high speed signal line.
3. Original inner electrode structure enables extra low crosstalk.
4. The nickel barrier structure of the external electrodes provides excellent solder heat resistance. Both flow and reflow soldering methods can be employed.

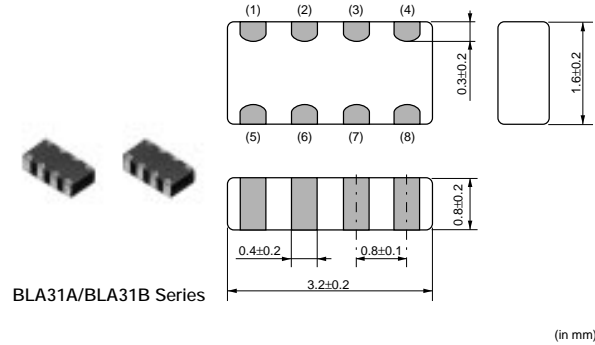

1

| Part Number | Impedance (at 100MHz/20°C) (ohm) | Rated Current (mA) | DC Resistance (max.) (ohm) | Operating Temperature Range (°C) |
|---------------|--|-----------------------|-------------------------------|--|
| BLA31AG300SN4 | 30 ±25% | 200 | 0.10 | -55 to +125 |
| BLA31AG600SN4 | 60 ±25% | 200 | 0.15 | -55 to +125 |
| BLA31AG121SN4 | 120 ±25% | 150 | 0.20 | -55 to +125 |
| BLA31AG221SN4 | 220 ±25% | 150 | 0.25 | -55 to +125 |
| BLA31AG601SN4 | 600 ±25% | 100 | 0.35 | -55 to +125 |
| BLA31AG102SN4 | 1000 ±25% | 50 | 0.45 | -55 to +125 |
| BLA31BD121SN4 | 120 ±25% | 150 | 0.30 | -55 to +125 |
| BLA31BD221SN4 | 220 ±25% | 150 | 0.35 | -55 to +125 |
| BLA31BD471SN4 | 470 ±25% | 100 | 0.40 | -55 to +125 |
| BLA31BD601SN4 | 600 ±25% | 100 | 0.45 | -55 to +125 |
| BLA31BD102SN4 | 1000 ±25% | 50 | 0.55 | -55 to +125 |

Number of Circuits: 4

■ Equivalent Circuit

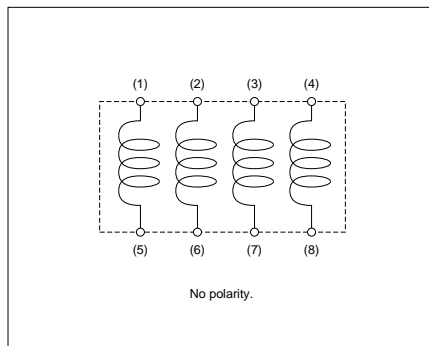

■ Impedance - Frequency (Typical)

BLA31A Series

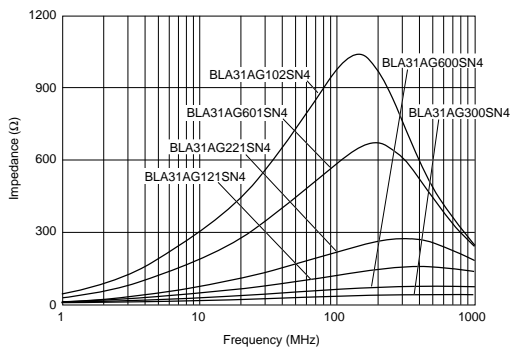

BLA31B Series

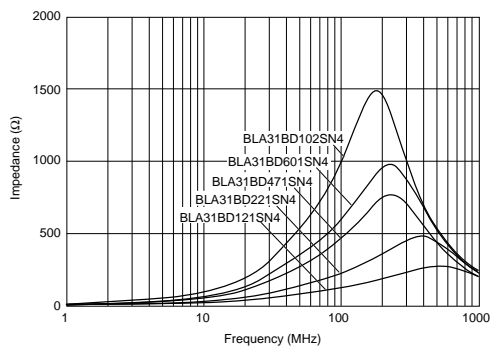

■ Impedance - Frequency Characteristics

BLA31AG300SN4

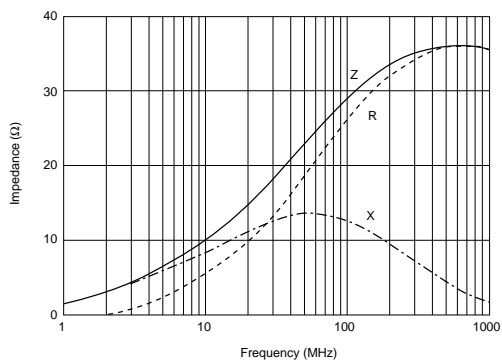

BLA31AG600SN4

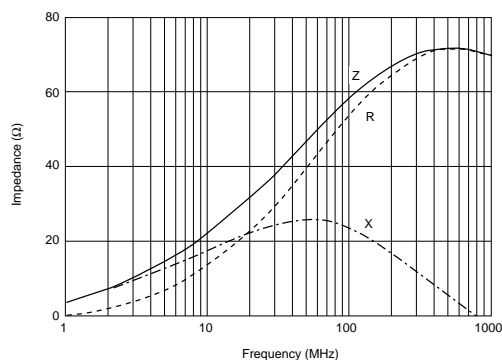

BLA31AG121SN4

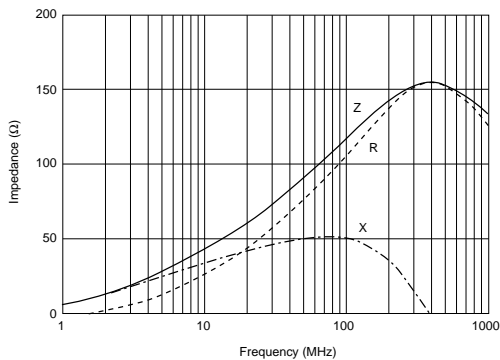

BLA31AG221SN4

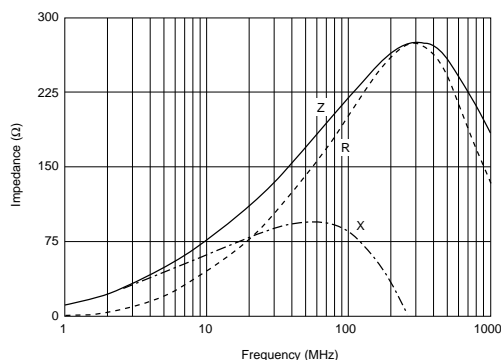

BLA31AG601SN4

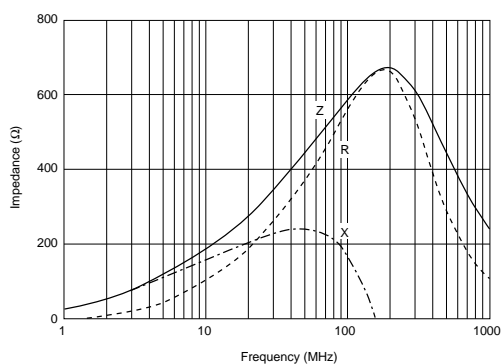

BLA31AG102SN4

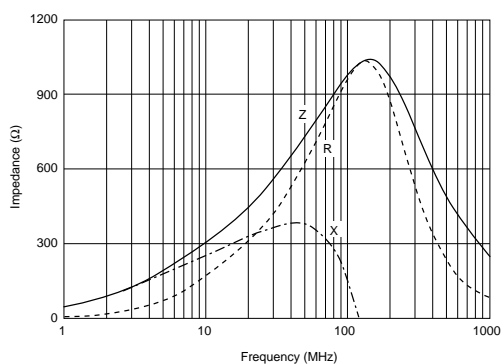

1

Continued from the preceding page.

Impedance - Frequency Characteristics

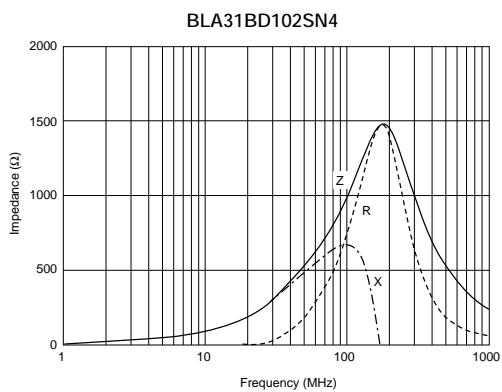
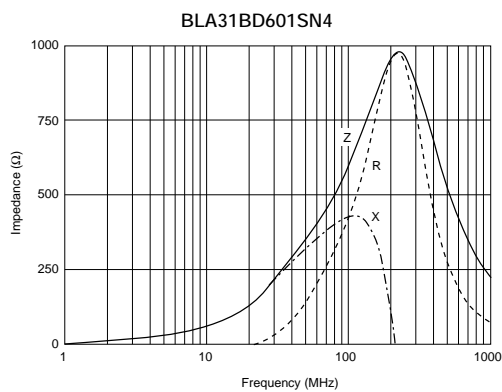
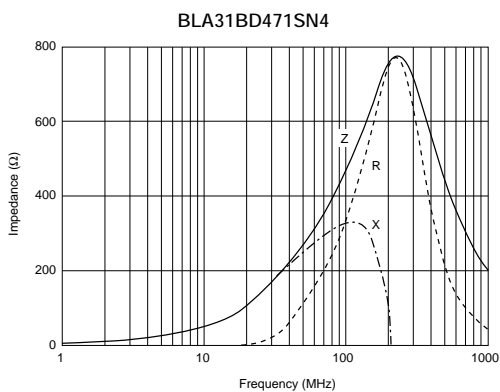
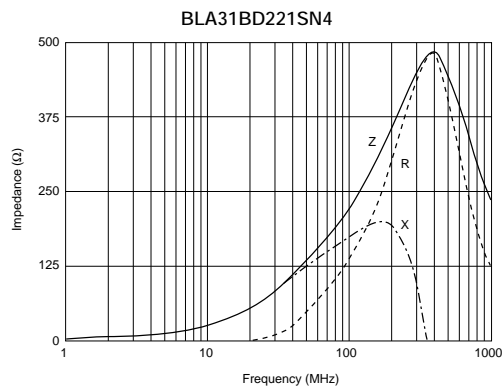
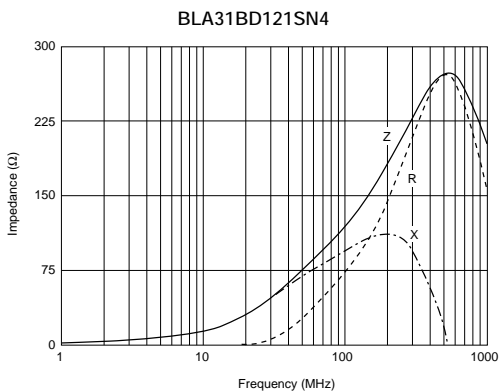

1

On-Board Type (DC) EMI Suppression Filters (EMIFIL®)



Chip EMIFIL® Part Numbering

Chip EMIFIL® Capacitor Type/Capacitor Array Type

(Part Number)

| | | | | | | | | |
|----|---|----|----|-----|---|----|---|---|
| NF | M | 3D | CC | 102 | R | 1H | 3 | L |
| ① | ② | ③ | ④ | ⑤ | ⑥ | ⑦ | ⑧ | ⑨ |

① Product ID

| Product ID | |
|------------|--------------|
| NF | Chip EMIFIL® |

② Structure

| Code | Structure |
|------|----------------------|
| M | Capacitor Type |
| A | Capacitor Array Type |

③ Dimensions (L×W)

| Code | Dimensions (L×W) | EIA |
|------|------------------|------|
| 18 | 1.6×0.8mm | 0603 |
| 21 | 2.0×1.25mm | 0805 |
| 3D | 3.2×1.25mm | 1205 |
| 31 | 3.2×1.6mm | 1206 |
| 41 | 4.5×1.6mm | 1806 |
| 55 | 5.7×5.0mm | 2220 |

④ Features

| Code | Features |
|------|----------------------------------|
| CC | Capacitor Type for Signal Lines |
| PC | Capacitor Type for Large Current |
| PS | High Loss Type for Large Current |

⑤ Capacitance

Expressed by three figures. The unit is in pico-farad (pF). The first and second figures are significant digits, and the third figure expresses the number of zeros which follow the two figures.

⑨ Packaging

| Code | Packaging | Series |
|------|-------------------------------|----------------------------|
| L | Embossed Taping (ø180mm Reel) | NFM3D/NFM41/NFM55 |
| B | Bulk | All series |
| D | Paper Taping (ø180mm Reel) | NFM18/NFM21/NFA□□CC |

⑥ Characteristics

| Code | Capacitance Change (Temperature Characteristics) |
|------|--|
| B | ±10% |
| F | +30/-80% |
| R | ±15% |
| U | -750 ±120ppm/°C |
| S | +350 to -1000ppm/°C |

⑦ Rated Voltage

| Code | Rated Voltage |
|------|---------------|
| 0J | 6.3V |
| 1A | 10V |
| 1C | 16V |
| 1E | 25V |
| 1H | 50V |
| 2A | 100V |

⑧ Electrode/Others (NFM Series)

| Code | Electrode | Series |
|------|----------------|---------------------------|
| 3 | Sn Plating | NFM (Except NFM55) |
| 4 | Solder Coating | NFM55 |

⑥ Number of Circuits (NFA□□CC Series)

| Code | Number of Circuits |
|------|--------------------|
| 4 | 4 Circuits |

Chip EMIFIL® LC Combined Type

(Part Number)

| | | | | | | | | |
|----|---|----|----|-----|---|----|---|---|
| NF | L | 18 | ST | 107 | X | 1C | 3 | L |
| ① | ② | ③ | ④ | ⑤ | ⑥ | ⑦ | ⑧ | ⑨ |

① Product ID

| Product ID | |
|------------|--------------|
| NF | Chip EMIFIL® |

② Structure

| Code | Structure |
|------|------------------------------|
| L | Monolithic, LC Combined Type |
| W | Winding, LC Combined Type |
| E | Block, LC Combined Type |

③ Dimensions (L×W)

| Code | Dimensions (L×W) | EIA |
|------|------------------|------|
| 18 | 1.6×0.8mm | 0603 |
| 21 | 2.0×1.25mm | 0805 |
| 31 | 3.2×1.6mm | 1206 |
| 61 | 6.8×1.6mm | 2606 |

④ Features

| Code | Features |
|------|-----------------------------|
| SP | π Circuit for Signal Lines |
| ST | T Circuit for Signal Lines |
| PT | T Circuit for Large Current |

⑤ Cut-off Frequency (NFL/NFW Series)

Expressed by three figures. The unit is in hertz (Hz). The first and second figures are significant digits, and the third figure expresses the number of zeros which follow the two figures.

⑥ Capacitance (NFE Series)

Expressed by three figures. The unit is in pico-farad (pF). The first and second figures are significant digits, and the third figure expresses the number of zeros which follow the two figures.

⑨ Packaging

| Code | Packaging | Series |
|------|-------------------------------|-----------------|
| K | Embossed Taping (ø330mm Reel) | NFW31/NFE |
| L | Embossed Taping (ø180mm Reel) | NFW31/NFE |
| B | Bulk | NFL18/NFL21/NFE |
| D | Paper Taping (ø180mm Reel) | NFL18/NFL21 |

⑥ Characteristics (NFL/NFW Series)

| Code | Characteristics |
|------|-------------------|
| X | Cut-off Frequency |

⑥ Characteristics (NFE Series)

| Code | Capacitance Change (Temperature Characteristics) |
|------|--|
| B | ±10% |
| C | ±20%, ±22% |
| D | +20/-30%, +22/-33% |
| E | +20/-55%, +22/-56% |
| F | +30/-80%, +22/-82% |
| R | ±15% |
| U | -750 ±120ppm/ °C |
| Z | Other |

⑦ Rated Voltage

| Code | Rated Voltage |
|------|---------------|
| 1A | 10V |
| 1C | 16V |
| 1E | 25V |
| 1H | 50V |
| 2A | 100V |

⑧ Electrode

| Code | Electrode | Series |
|------|--------------------------|--------|
| 3/7 | Sn Plating | NFL |
| 4 | Lead Free Solder Coating | NFW |
| 9 | Others | NFE |

2

Chip EMIFIL® LC Combined Array Type (NFA18S/21S Series)

(Part Number)

| | | | | | | | | | |
|----|---|----|----|-----|---|----|---|---|---|
| NF | A | 21 | SL | 207 | X | 1A | 4 | 5 | L |
| ① | ② | ③ | ④ | ⑤ | ⑥ | ⑦ | ⑧ | ⑨ | ⑩ |

① Product ID

| Product ID | |
|------------|--------------|
| NF | Chip EMIFIL® |

② Structure

| Code | Structure |
|------|------------|
| A | Array Type |

③ Dimensions (L×W)

| Code | Dimensions (L×W) | EIA |
|------|------------------|------|
| 18 | 1.6×0.8mm | 0603 |
| 21 | 2.0×1.25mm | 0805 |

④ Features

| Code | Features |
|------|----------------------------|
| SL | L Circuit for Signal Lines |

⑤ Cut-off Frequency

Expressed by three figures. The unit is in hertz (Hz). The first and second figures are significant digits, and the third figure expresses the number of zeros which follow the two figures.

⑥ Features

| Code | Features |
|------|-----------------------|
| X | Expressed by a letter |
| V | |

⑦ Rated Voltage

| Code | Rated Voltage |
|------|---------------|
| 1A | 10V |

⑧ Number of Circuits

| Code | Number of Circuits |
|------|--------------------|
| 4 | 4 Circuits |

⑨ Dimensions (T)

| Code | Dimensions (T) |
|------|----------------|
| 5 | Low Profile |
| 8 | Standard |

⑩ Packaging

| Code | Packaging |
|------|-------------------------------|
| B | Bulk |
| L | Embossed Taping (ø180mm Reel) |

Chip EMIFIL® RC Combined Type/RC Combined Array Type

(Part Number)

| | | | | | | | |
|----|---|----|----|-----|-----|---|---|
| NF | R | 21 | GD | 470 | 470 | 2 | L |
| ① | ② | ③ | ④ | ⑤ | ⑥ | ⑦ | ⑧ |

① Product ID

| Product ID | |
|------------|--------------|
| NF | Chip EMIFIL® |

② Structure

| Code | Structure |
|------|------------------------|
| R | RC Combined Type |
| A | RC Combined Array Type |

③ Dimensions (L×W)

| Code | Dimensions (L×W) | EIA |
|------|------------------|------|
| 21 | 2.0×1.25mm | 0805 |
| 31 | 3.2×1.6mm | 1206 |

④ Features

| Code | Features |
|------|-----------------------------------|
| GD | RC Combined Type for Signal Lines |

⑥ Packaging

| Code | Packaging | Series |
|------|-------------------------------|------------|
| L | Embossed Taping (ø180mm Reel) | NFR |
| B | Bulk | All Series |
| D | Paper Taping (ø180mm Reel) | NFA□□GD |

⑤ Capacitance

Expressed by three figures. The unit is in pico-farad (pF). The first and second figures are significant digits, and the third figure expresses the number of zeros which follow the two figures.

⑥ Resistance

Expressed by three-digit alphanumerics. The unit is in ohm (Ω). The first and second figures are significant digits, and the third figure expresses the number of zeros which follow the two figures. If there is a decimal point, it is expressed by the capital letter "R". In this case, all figures are significant digits.

⑦ Electrode/Others (NFR Series)

| Code | Electrode |
|------|------------|
| 2 | Sn Plating |

⑦ Number of Circuits (NFA□□GD Series)

| Code | Number of Circuits |
|------|--------------------|
| 4 | 4 Circuits |

On-Board Type (DC) EMI Suppression Filters (EMIFIL®)



Chip EMIFIL® Capacitor Type NFM18C/21C/3DC/41C Series

NFM18C Series

NFM18C series is a 1.6x0.8mm EMI suppression filter for signal lines which have a three terminal structure using Murata's multilayer technology.

■ Features

1. Ultra small size in 1.6x0.8x0.6mm enables high density mounting.
2. Three terminal structure with low residual inductance (ESL)* characteristics achieves large insertion loss characteristics even in high frequency area.
3. NFM18C series covers capacitance range from 22 to 22,000pF.

* Not exceeding one-tenth of monolithic ceramic capacitors (two terminals).

■ Applications

1. EMI suppression of circuit for insertion loss in quantity
2. Noise suppression up to GHz

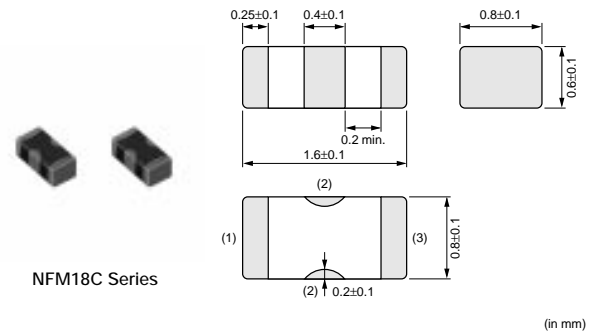

2

| Part Number | Capacitance (pF) | Rated Voltage (Vdc) | Rated Current (mA) | Insulation Resistance (min.) (M ohm) | Operating Temperature Range (°C) |
|----------------|------------------|---------------------|--------------------|--------------------------------------|----------------------------------|
| NFM18CC220U1C3 | 22 +20%, -20% | 16 | 400 | 1000 | -55 to +125 |
| NFM18CC470U1C3 | 47 +20%, -20% | 16 | 400 | 1000 | -55 to +125 |
| NFM18CC101R1C3 | 100 +20%, -20% | 16 | 500 | 1000 | -55 to +125 |
| NFM18CC221R1C3 | 220 +20%, -20% | 16 | 500 | 1000 | -55 to +125 |
| NFM18CC471R1C3 | 470 +20%, -20% | 16 | 500 | 1000 | -55 to +125 |
| NFM18CC102R1C3 | 1000 +20%, -20% | 16 | 600 | 1000 | -55 to +125 |
| NFM18CC222R1C3 | 2200 +20%, -20% | 16 | 700 | 1000 | -55 to +125 |
| NFM18CC223R1C3 | 22000 +20%, -20% | 16 | 1000 | 1000 | -55 to +125 |

■ Equivalent Circuit

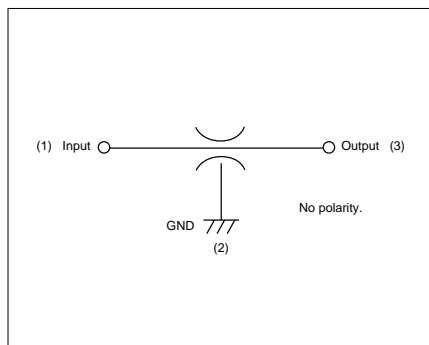

■ Insertion Loss Characteristics

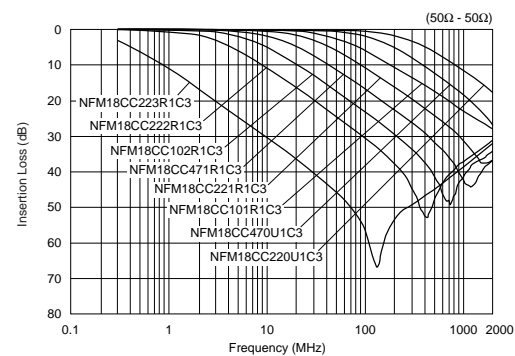

NFM21C Series

The chip "EMIFIL" NFM21C series is a chip type three terminal EMI suppression filter. It can reduce residual inductance to an extremely low level making it excellent for noise suppression at high frequencies.

■ Features

1. Small and low profile of 2.0x1.25x0.85mm enables high density mounting.
2. Three terminal structure enables high performance in high frequency range.
3. Uses original electrode structure which realizes excellent solderability.
4. An electrostatic capacitance range of 22 to 22,000pF enables suppression of noise at specific frequencies.

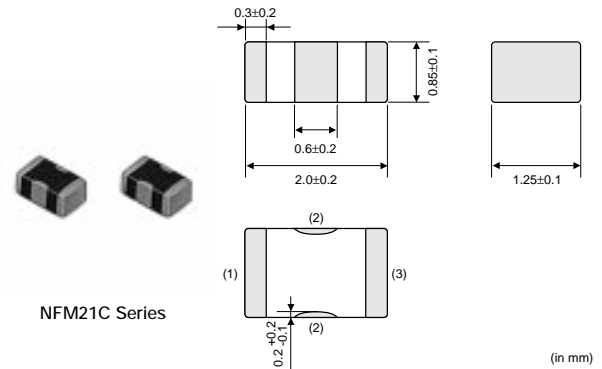

2

■ Applications

1. PCs and peripherals which emit high amount of noise
2. Compact size equipment such as PDAs, PC cards and mobile telecommunications equipment
3. Severe EMI suppression and high impedance circuits such as digital circuits

| Part Number | Capacitance (pF) | Rated Voltage (Vdc) | Rated Current (mA) | Insulation Resistance (min.) (M ohm) | Operating Temperature Range (°C) |
|----------------|------------------|---------------------|--------------------|--------------------------------------|----------------------------------|
| NFM21CC220U1H3 | 22 +20%, -20% | 50 | 700 | 1000 | -55 to +125 |
| NFM21CC470U1H3 | 47 +20%, -20% | 50 | 700 | 1000 | -55 to +125 |
| NFM21CC101U1H3 | 100 +20%, -20% | 50 | 700 | 1000 | -55 to +125 |
| NFM21CC221R1H3 | 220 +20%, -20% | 50 | 700 | 1000 | -55 to +125 |
| NFM21CC471R1H3 | 470 +20%, -20% | 50 | 1000 | 1000 | -55 to +125 |
| NFM21CC102R1H3 | 1000 +20%, -20% | 50 | 1000 | 1000 | -55 to +125 |
| NFM21CC222R1H3 | 2200 +20%, -20% | 50 | 1000 | 1000 | -55 to +125 |
| NFM21CC223R1H3 | 22000 +20%, -20% | 50 | 2000 | 1000 | -55 to +125 |

■ Equivalent Circuit

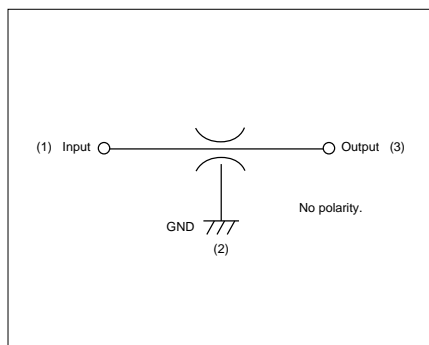

■ Insertion Loss Characteristics

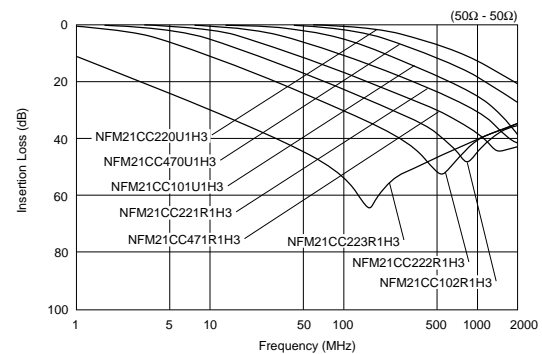

NFM3DC Series

The chip "EMIFIL" NFM3DC series is a chip type three terminal EMI suppression filter. It can reduce residual inductance to an extremely low level making it excellent for noise suppression at high frequencies.

■ Features

An electrostatic capacitance range of 22 to 22,000pF enables suppression of noise at specific frequencies.

■ Applications

High noise radiation and high impedance circuits such as digital circuits

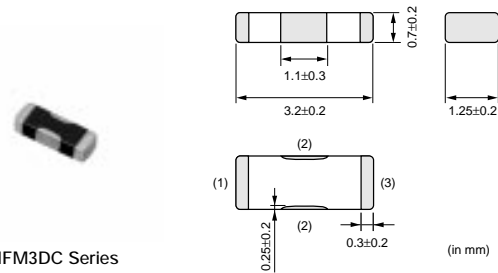

NFM3DC Series

| Part Number | Capacitance (pF) | Rated Voltage (Vdc) | Rated Current (mA) | Insulation Resistance (min.) (M ohm) | Operating Temperature Range (°C) |
|----------------|------------------|---------------------|--------------------|--------------------------------------|----------------------------------|
| NFM3DCC220U1H3 | 22 +50%, -20% | 50 | 300 | 1000 | -55 to +125 |
| NFM3DCC470U1H3 | 47 +50%, -20% | 50 | 300 | 1000 | -55 to +125 |
| NFM3DCC101U1H3 | 100 +50%, -20% | 50 | 300 | 1000 | -55 to +125 |
| NFM3DCC221R1H3 | 220 +50%, -20% | 50 | 300 | 1000 | -55 to +125 |
| NFM3DCC471R1H3 | 470 +50%, -20% | 50 | 300 | 1000 | -55 to +125 |
| NFM3DCC102R1H3 | 1000 +50%, -20% | 50 | 300 | 1000 | -55 to +125 |
| NFM3DCC222R1H3 | 2200 +50%, -20% | 50 | 300 | 1000 | -55 to +125 |
| NFM3DCC223R1H3 | 22000 +50%, -20% | 50 | 300 | 1000 | -55 to +125 |

2

■ Equivalent Circuit

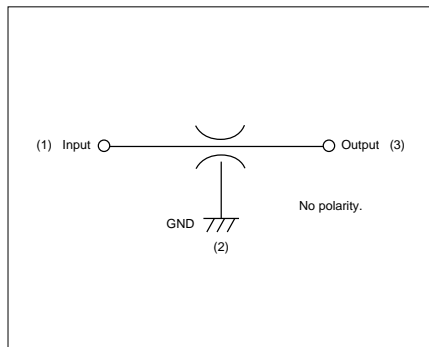

■ Insertion Loss Characteristics

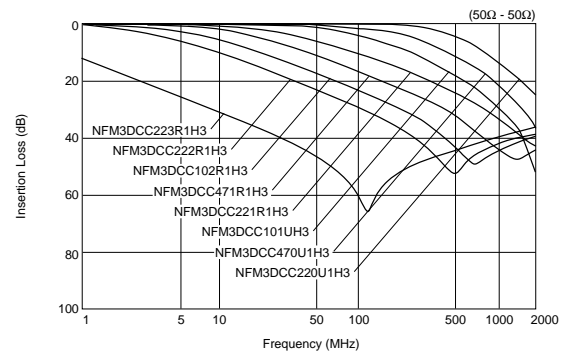

NFM41C Series

The chip "EMIFIL" NFM41C series is a chip type three terminal EMI suppression filter. It can reduce residual inductance to an extremely low level making it excellent for noise suppression at high frequencies.

■ Features

An electrostatic capacitance range of 22 to 22,000pF enables suppression of noise at specific frequencies.

■ Applications

High noise radiation and high impedance circuits such as digital circuits

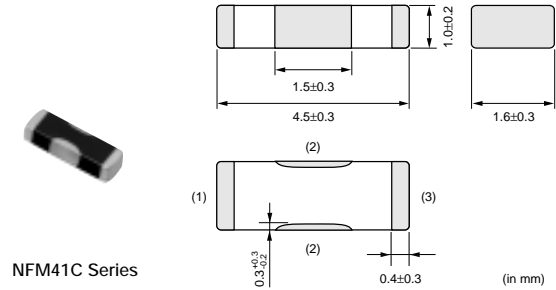

2

| Part Number | Capacitance (pF) | Rated Voltage (Vdc) | Rated Current (mA) | Insulation Resistance (min.) (M ohm) | Operating Temperature Range (°C) |
|----------------|------------------|---------------------|--------------------|--------------------------------------|----------------------------------|
| NFM41CC220U2A3 | 22 +50%, -20% | 100 | 300 | 10000 | -55 to +125 |
| NFM41CC470U2A3 | 47 +50%, -20% | 100 | 300 | 10000 | -55 to +125 |
| NFM41CC101U2A3 | 100 +50%, -20% | 100 | 300 | 10000 | -55 to +125 |
| NFM41CC221U2A3 | 220 +50%, -20% | 100 | 300 | 10000 | -55 to +125 |
| NFM41CC471R2A3 | 470 +50%, -20% | 100 | 300 | 10000 | -55 to +125 |
| NFM41CC102R2A3 | 1000 +50%, -20% | 100 | 300 | 10000 | -55 to +125 |
| NFM41CC222R2A3 | 2200 +50%, -20% | 100 | 300 | 10000 | -55 to +125 |
| NFM41CC223R2A3 | 22000 +50%, -20% | 100 | 300 | 10000 | -55 to +125 |

■ Equivalent Circuit

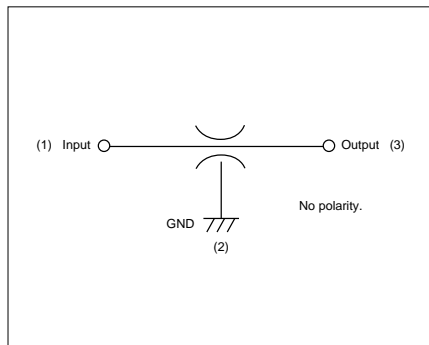

■ Insertion Loss Characteristics

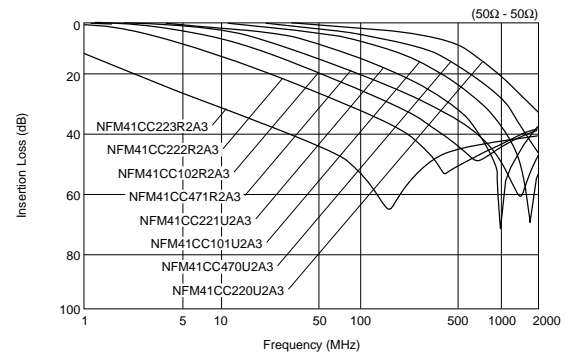

On-Board Type (DC) EMI Suppression Filters (EMIFIL®)



Chip EMIFIL® Capacitor Array Type NFA31C Series

NFA31C Series

NFA31C series is a chip EMI suppression filter for surface mount applications using Murata's ceramic processing technology and filter design technology. The series is well suited for EMI suppression in digital I/O lines of varied electronic equipment such as notebook size PCs.

■ Features

1. High density mounting can be realized because of 4 circuits in one package with 0.8mm pitch.
2. Suitable for high frequency noise suppression because of low residual inductance of three terminal structure.
3. Excellent EMI suppression can be realized because of two terminal simple GNDs for 4 circuits.
4. 22 to 22,000pF lineups can be used depending on noise frequency.

■ Applications

1. Personal computers and peripherals
2. Telephones, PPCs, communications equipment
3. Digital TVs, DVDs



NFA31C Series

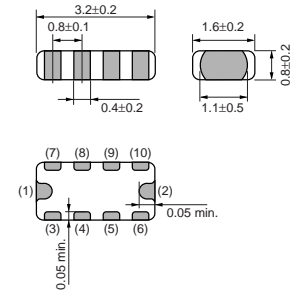

(in mm)

2

| Part Number | Capacitance (pF) | Rated Voltage (Vdc) | Rated Current (mA) | Insulation Resistance (min.) (M ohm) | Operating Temperature Range (°C) |
|----------------|------------------|---------------------|--------------------|--------------------------------------|----------------------------------|
| NFA31CC220S1E4 | 22 +20%, -20% | 25 | 200 | 1000 | -40 to +85 |
| NFA31CC470S1E4 | 47 +20%, -20% | 25 | 200 | 1000 | -40 to +85 |
| NFA31CC101S1E4 | 100 +20%, -20% | 25 | 200 | 1000 | -40 to +85 |
| NFA31CC221S1E4 | 220 +20%, -20% | 25 | 200 | 1000 | -40 to +85 |
| NFA31CC471R1E4 | 470 +20%, -20% | 25 | 200 | 1000 | -40 to +85 |
| NFA31CC102R1E4 | 1000 +20%, -20% | 25 | 200 | 1000 | -40 to +85 |
| NFA31CC222R1E4 | 2200 +20%, -20% | 25 | 200 | 1000 | -40 to +85 |
| NFA31CC223R1C4 | 22000 +20%, -20% | 16 | 200 | 1000 | -40 to +85 |

Number of Circuits: 4

■ Equivalent Circuit

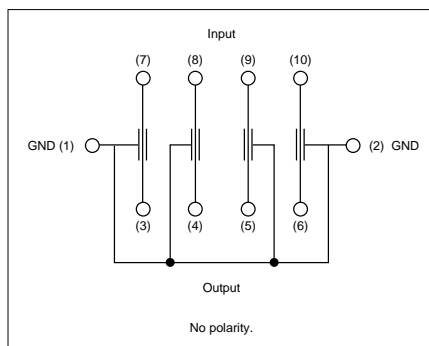

■ Insertion Loss Characteristics

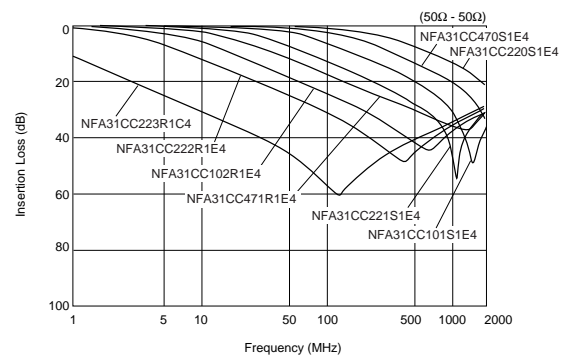

On-Board Type (DC) EMI Suppression Filters (EMIFIL®)



Chip EMIFIL® LC Combined Monolithic Type NFL18ST/18SP/21S Series

NFL18ST Series

NFL18ST series is an EMI suppression filter for high speed signal lines, achieving T-type structure in 1.6x0.8mm size with Murata's multilayer technology.

■ Features

1. Ultra-small size in 1.6x0.8x0.8mm
2. Steep insertion loss characteristics realize excellent noise suppression and prevent distortion of signal waveform.
3. By minimizing stray capacitance of inductor, achieves high performance in noise suppression in high frequency range.
4. Three different values of cut-off frequency are available, ranging from 200MHz up to 500MHz.
5. Since all side electrode structures are the same, it is no polarity.

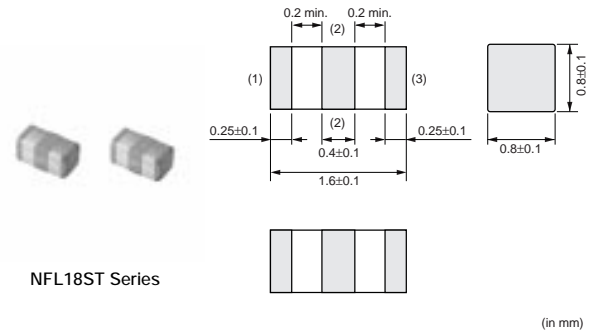

■ Applications

Noise suppression for video signal lines (RGB lines) and high speed clock lines

| Part Number | Cut-off Frequency (MHz) | Capacitance (pF) | Inductance (nH) | Rated Voltage (Vdc) | Rated Current (mA) | Insulation Resistance (M ohm) | Operating Temperature Range (°C) |
|----------------|-------------------------|------------------|-----------------|---------------------|--------------------|-------------------------------|----------------------------------|
| NFL18ST207X1C3 | 200 | 25 +20%, -20% | 110 +20%, -20% | 16 | 150 | 1000 | -55 to 125 |
| NFL18ST307X1C3 | 300 | 18 +20%, -20% | 62 +20%, -20% | 16 | 200 | 1000 | -55 to 125 |
| NFL18ST507X1C3 | 500 | 10 +20%, -20% | 43 +20%, -20% | 16 | 200 | 1000 | -55 to 125 |

Number of Circuits: 1

■ Equivalent Circuit

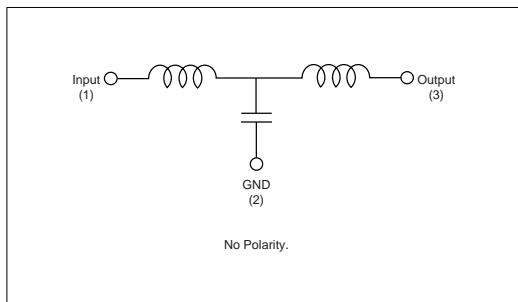

■ Insertion Loss Characteristics

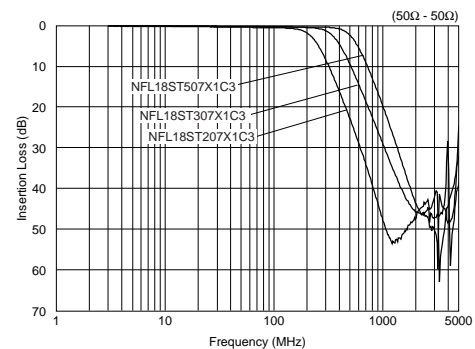

NFL18SP Series

The chip "EMIFIL" NFL18SP series is an EMI Suppression filter for high speed signal lines, achieving pi-type structure in 0603 size with Murata's multilayer technology.

■ Features

1. Ultra-small size in 1.6x0.8x0.6 mm
2. Achieves high performance in noise suppression over wide frequency range
3. Steep insertion loss characteristics realize excellent noise suppression and prevent distortion of signal waveform.
4. Line up 4 items of cut-off frequency range from 150 to 500MHz

■ Applications

EMI suppression for digital signal line such as RGB and high speed clock lines

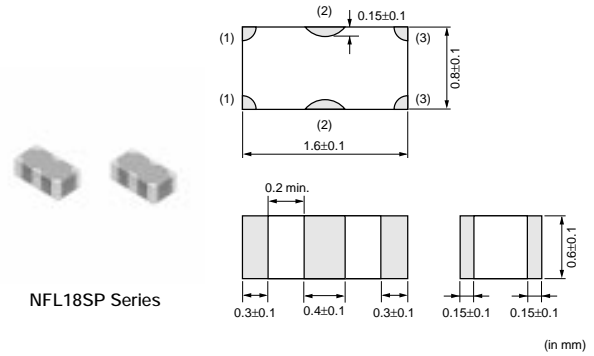

| Part Number | Cut-off Frequency (MHz) | Capacitance (pF) | Inductance (nH) | Rated Voltage (Vdc) | Rated Current (mA) | Insulation Resistance (M ohm) | Operating Temperature Range (°C) |
|----------------|-------------------------|------------------|-----------------|---------------------|--------------------|-------------------------------|----------------------------------|
| NFL18SP157X1A3 | 150 | 34 +20%, -20% | 100 +20%, -20% | 10 | 100 | 1000 | -55 to 125 |
| NFL18SP207X1A3 | 200 | 24 +20%, -20% | 80 +20%, -20% | 10 | 100 | 1000 | -55 to 125 |
| NFL18SP307X1A3 | 300 | 19 +20%, -20% | 60 +20%, -20% | 10 | 100 | 1000 | -55 to 125 |
| NFL18SP507X1A3 | 500 | 11 +20%, -20% | 38 +20%, -20% | 10 | 100 | 1000 | -55 to 125 |

Number of Circuits: 1

■ Equivalent Circuit

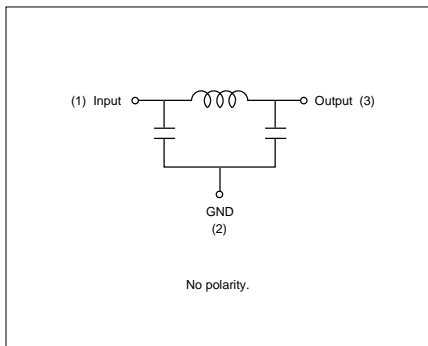

■ Insertion Loss Characteristics

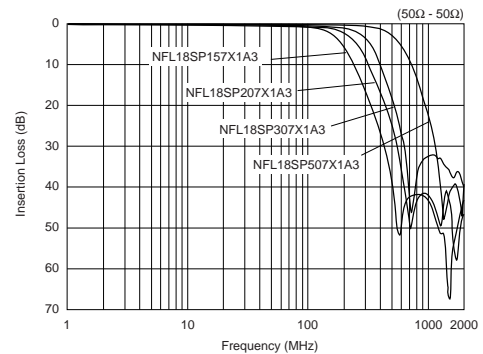

NFL21S Series

The chip "EMIFIL" NFL21S series is a high performance EMI suppression filter in 2.0x1.25mm size for high speed signal lines by using Murata's processing technology.

■ Features

1. Suppresses noise with little attenuation of the signal itself due to its steep filtering characteristics.
2. Murata's original internal structure design enables excellent noise suppression up to high frequencies.
3. Available in ten different values of cut-off frequency ranging from 10MHz up to 500MHz.

■ Applications

Suppression of high magnitude radiated noise generated by high speed digital circuits such as clock and RGB

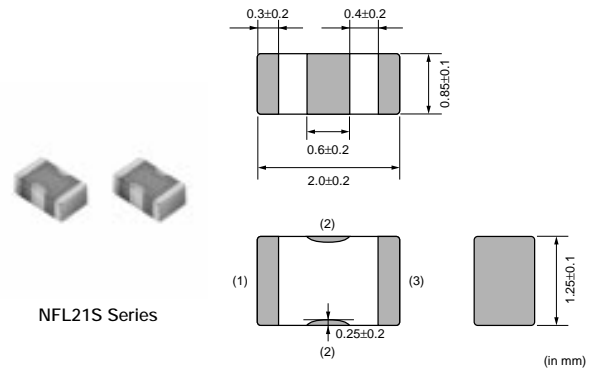

2

| Part Number | Cut-off Frequency (MHz) | Capacitance (pF) | Inductance (nH) | Rated Voltage (Vdc) | Rated Current (mA) | Insulation Resistance (M ohm) | Operating Temperature Range (°C) |
|----------------|-------------------------|------------------|-----------------|---------------------|--------------------|-------------------------------|----------------------------------|
| NFL21SP106X1C3 | 10 | 670 +20%, -20% | 680 +20%, -20% | 16 | 100 | 1000 | -55 to 125 |
| NFL21SP206X1C7 | 20 | 240 +20%, -20% | 700 +20%, -20% | 16 | 100 | 1000 | -55 to 125 |
| NFL21SP506X1C3 | 50 | 84 +20%, -20% | 305 +20%, -20% | 16 | 150 | 1000 | -55 to 125 |
| NFL21SP706X1C3 | 70 | 76 +20%, -20% | 185 +20%, -20% | 16 | 150 | 1000 | -55 to 125 |
| NFL21SP107X1C3 | 100 | 44 +20%, -20% | 135 +20%, -20% | 16 | 200 | 1000 | -55 to 125 |
| NFL21SP157X1C3 | 150 | 28 +20%, -20% | 128 +20%, -20% | 16 | 200 | 1000 | -55 to 125 |
| NFL21SP207X1C3 | 200 | 22 +20%, -20% | 72 +20%, -20% | 16 | 250 | 1000 | -55 to 125 |
| NFL21SP307X1C3 | 300 | 19 +10%, -10% | 45 +10%, -10% | 16 | 300 | 1000 | -55 to 125 |
| NFL21SP407X1C3 | 400 | 16 +10%, -10% | 34 +10%, -10% | 16 | 300 | 1000 | -55 to 125 |
| NFL21SP507X1C3 | 500 | 12 +10%, -10% | 31 +10%, -10% | 16 | 300 | 1000 | -55 to 125 |

Number of Circuits: 1

■ Equivalent Circuit

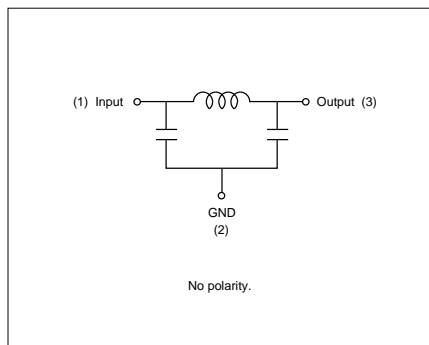

■ Insertion Loss Characteristics

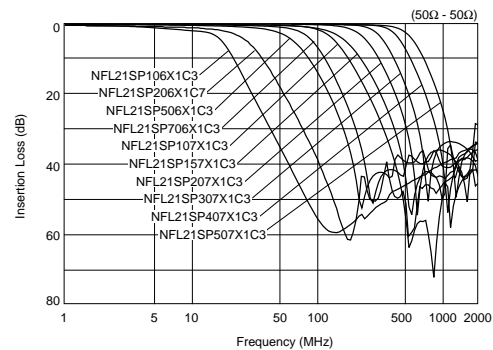

On-Board Type (DC) EMI Suppression Filters (EMIFIL®)



Chip EMIFIL® LC Combined Array Type NFA18S/21S Series

NFA18S Series

■ Features

1. NFA18SL series is LC combined noise suppression filter whose noise suppression curve is very steep and deep in spite of its small shape.
2. [cutoff frequency 300MHz, 400MHz, 480MHz type]
These products have good noise suppression effect at the frequency range over 800MHz which is important for sensitivity of mobile phones, and suppress radiation noise from LCD lines or camera module lines very well.
[cutoff frequency 130MHz, 180MHz, 200MHz type]
These products have good noise suppression effect at UHF range in addition to 800MHz range.
This characteristics works well at noise suppression for improvement of sensitivity at digital TVs.
3. Various cutoff frequency is available to control signal rise speed and signal fall speed.
4. circuits are built in 1.6x0.8mm chip size, it saves the large amount of mounting space.

■ Application

Noise suppression of LCD signal lines, camera module lines.

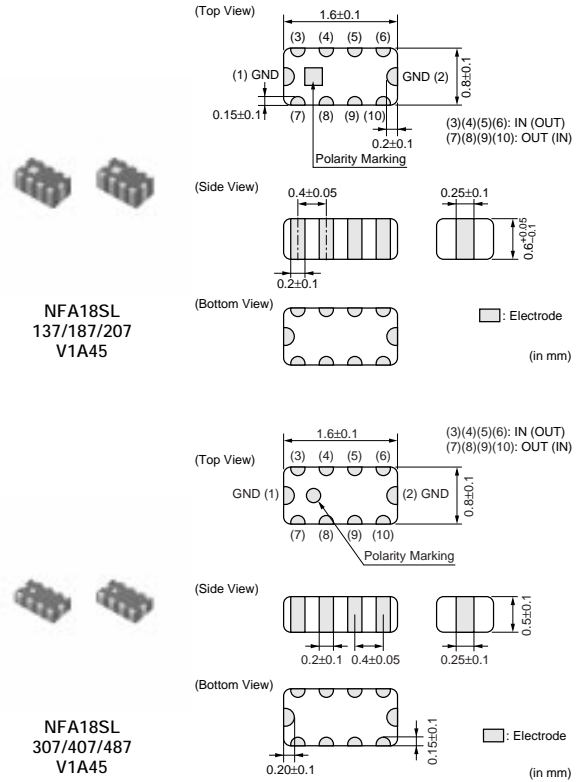

| Part Number | Cut-off Frequency (MHz) | Insertion Loss at Cut-off Frequency (dB) | Insertion Loss at 470MHz (min.) (dB) | Insertion Loss at 800MHz (min.) (dB) | Insertion Loss at 900MHz (min.) (dB) | Insulation Resistance (min.) (M ohm) | Rated Voltage (Vdc) | Rated Current (mA) | Withstand Voltage (Vdc) |
|-----------------|-------------------------|--|--------------------------------------|--------------------------------------|--------------------------------------|--------------------------------------|---------------------|--------------------|-------------------------|
| NFA18SL137V1A45 | 130 | 6 max | 25 | - | 25 | 1000 | 10 | 50 | 30 |
| NFA18SL187V1A45 | 180 | 6 max | 20 | - | 20 | 1000 | 10 | 50 | 30 |
| NFA18SL207V1A45 | 200 | 6 max | 15 | - | 15 | 1000 | 10 | 50 | 30 |
| NFA18SL307V1A45 | 300 | 6 max | - | 20 | 20 | 1000 | 10 | 100 | 30 |
| NFA18SL407V1A45 | 400 | 6 max | - | 18 | 18 | 1000 | 10 | 100 | 30 |
| NFA18SL487V1A45 | 480 | 6 max | - | 15 | 15 | 1000 | 10 | 100 | 30 |

Operating Temperature Range: -40°C to +85°C Number of Circuits: 4

■ Equivalent Circuit

NFA18SL 137/187/207 V1A45

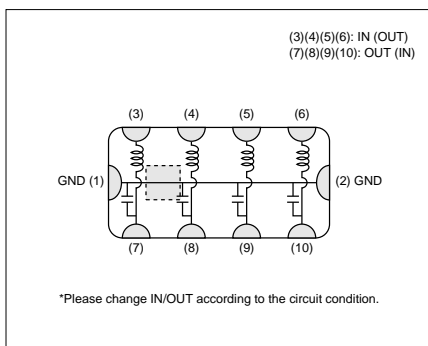

NFA18SL 307/407/487 V1A45

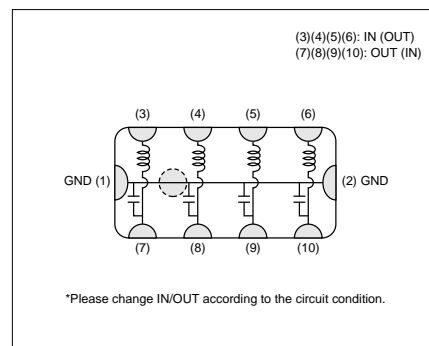

Continued on the following page.

Continued from the preceding page.

Insertion Loss Characteristics

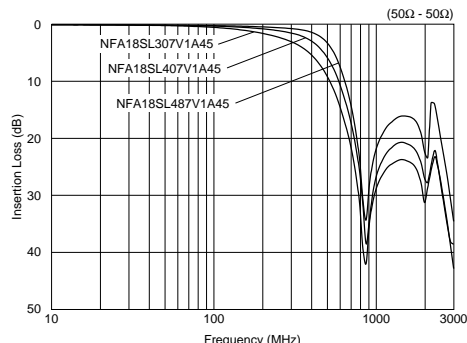
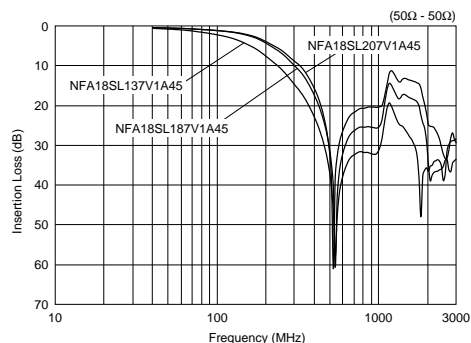

2

NFA21S Series

Features

1. Steep insertion loss characteristics
2. Suitable for noise suppression in 800MHz or higher frequency
3. Size: 2.0x1.25mm
4. 4 circuits in one package

Applications

Noise suppression for LCD line

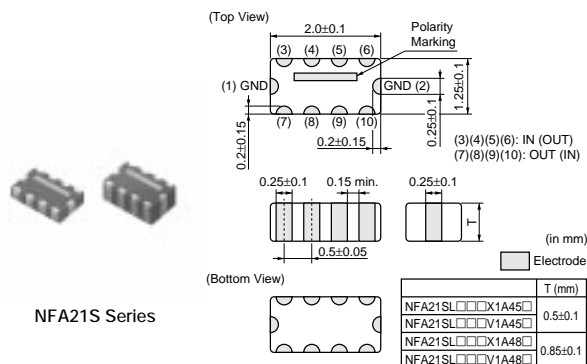

NFA21S Series

| Part Number | Cut-off Frequency (MHz) | Insertion Loss at Cut-off Frequency (dB) | Insertion Loss at 500MHz (min.) (dB) | Insertion Loss at 800MHz (min.) (dB) | Insertion Loss at 900MHz (min.) (dB) | Insertion Loss at 1000MHz (min.) (dB) | Insulation Resistance (M ohm) | Rated Voltage (Vdc) | Rated Current (mA) | Withstand Voltage (Vdc) |
|-----------------|-------------------------|--|--------------------------------------|--------------------------------------|--------------------------------------|---------------------------------------|-------------------------------|---------------------|--------------------|-------------------------|
| NFA21SL506X1A48 | 50 | 0 to 6 | 30 | - | - | 20 | 1000 | 10 | 20 | 30 |
| NFA21SL806X1A48 | 80 | 2 to 7 | 25 | - | - | 25 | 1000 | 10 | 20 | 30 |
| NFA21SL207X1A45 | 200 | 2 to 7 | 13 | 25 | - | 25 | 1000 | 10 | 100 | 30 |
| NFA21SL207X1A48 | 200 | 2 to 7 | 13 | 25 | - | 25 | 1000 | 10 | 100 | 30 |
| NFA21SL307X1A45 | 300 | 2 to 7 | 7 | 20 | - | 25 | 1000 | 10 | 100 | 30 |
| NFA21SL307X1A48 | 300 | 2 to 7 | 7 | 20 | - | 25 | 1000 | 10 | 100 | 30 |
| NFA21SL287V1A45 | 280 | 6 max | - | 25 | 25 | - | 1000 | 10 | 100 | 30 |
| NFA21SL287V1A48 | 280 | 6 max | - | 25 | 25 | - | 1000 | 10 | 100 | 30 |
| NFA21SL317V1A45 | 310 | 6 max | - | 20 | 20 | - | 1000 | 10 | 100 | 30 |
| NFA21SL317V1A48 | 310 | 6 max | - | 20 | 20 | - | 1000 | 10 | 100 | 30 |
| NFA21SL337V1A45 | 330 | 6 max | - | 15 | 15 | - | 1000 | 10 | 100 | 30 |
| NFA21SL337V1A48 | 330 | 6 max | - | 20 | 20 | - | 1000 | 10 | 100 | 30 |

Operating Temperature Range: -55°C to +125°C Number of Circuits: 4

■ Equivalent Circuit

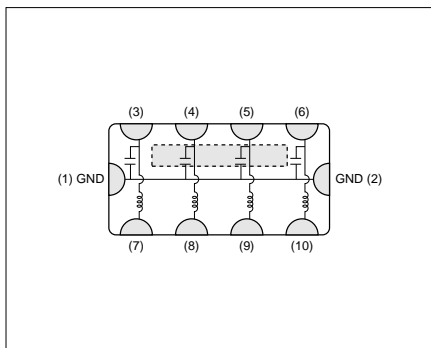

■ Insertion Loss Characteristics

NFA21SL_X Series

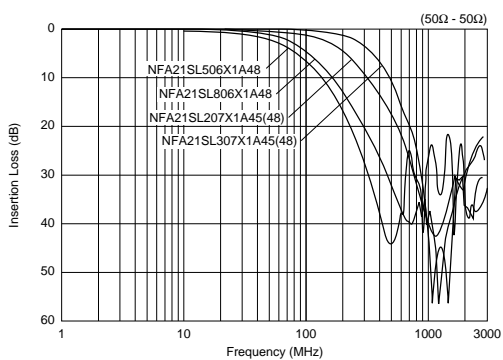

NFA21SL_V_48 Series

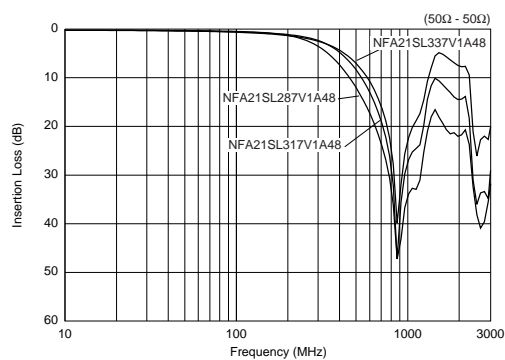

NFA21SL_V_45 Series

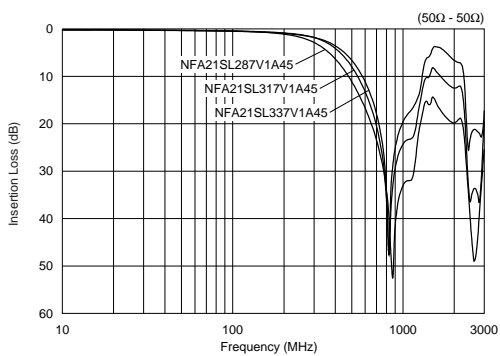

2

On-Board Type (DC) EMI Suppression Filters (EMIFIL®)



Chip EMIFIL® LC Combined Wire Wound Type NFW31S Series

NFW31S Series

The signal line chip EMI filter NFW31S series consists of high performance EMI suppression filters. They are designed for noise suppression in high speed signal digital circuits in which the signal harmonics are prone to becoming noise sources. These filters achieve a 100dB/dec. (typ.) damping characteristic with Murata's innovative circuit design. This makes these chips effective in applications where the signal and noise frequencies are close to each other.

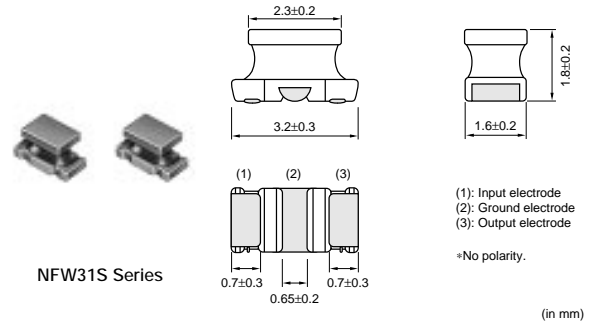

2

■ Features

1. Suppresses signal noise with little or no attenuation of the signal itself.
2. Murata's original internal structure design enables excellent noise suppression up to high frequencies (40dB at 1GHz typ.).
3. NFW31S series is available in 9 different values of cut-off frequency ranging from 10MHz up to 500MHz.

| Part Number | Nominal Cut-off Freq. (MHz) | Attenuation at 10MHz (dB) | Attenuation at 20MHz (dB) | Attenuation at 50MHz (dB) | Attenuation at 100MHz (dB) | Attenuation at 150MHz (dB) | Attenuation at 200MHz (dB) | Attenuation at 300MHz (dB) | Attenuation at 400MHz (dB) | Attenuation at 500MHz (dB) | Attenuation at 1000MHz (dB) |
|----------------|-----------------------------|---------------------------|---------------------------|---------------------------|----------------------------|----------------------------|----------------------------|----------------------------|----------------------------|----------------------------|-----------------------------|
| NFW31SP106X1E4 | 10 | 6 max. | 5 min. | 25 min. | 25 min. | - | 25 min. | - | - | 30 min. | 30 min. |
| NFW31SP206X1E4 | 20 | - | 6 max. | 5 min. | 25 min. | - | 25 min. | - | - | 30 min. | 30 min. |
| NFW31SP506X1E4 | 50 | - | - | 6 max. | 10 min. | - | 30 min. | - | - | 30 min. | 30 min. |
| NFW31SP107X1E4 | 100 | - | - | - | 6 max. | - | 5 min. | - | - | 20 min. | 30 min. |
| NFW31SP157X1E4 | 150 | - | - | - | - | 6 max. | - | 10 min. | 20 min. | 30 min. | 30 min. |
| NFW31SP207X1E4 | 200 | - | - | - | - | - | 6 max. | - | - | 10 min. | 30 min. |
| NFW31SP307X1E4 | 300 | - | - | - | - | - | - | 6 max. | - | 5 min. | 15 min. |
| NFW31SP407X1E4 | 400 | - | - | - | - | - | - | - | 6 max. | - | 10 min. |
| NFW31SP507X1E4 | 500 | - | - | - | - | - | - | - | - | 6 max. | 10 min. |

Rated Current: 200mA Rated Voltage: 25Vdc Operating Temperature Range: -40°C to 85°C

■ Equivalent Circuit

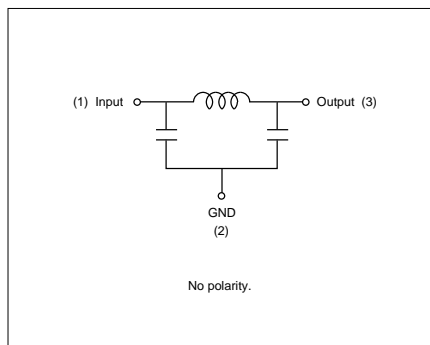

■ Insertion Loss Characteristics

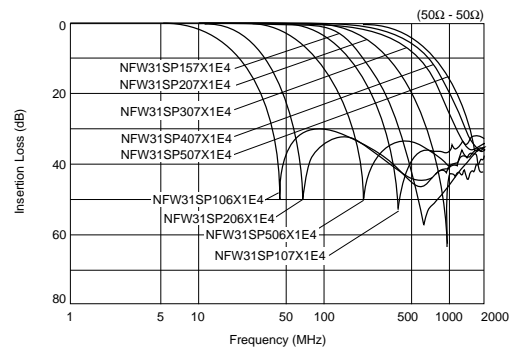

Noise Suppression Effect of NFW31S Series

Example of EMI Suppression in an Actual Circuit

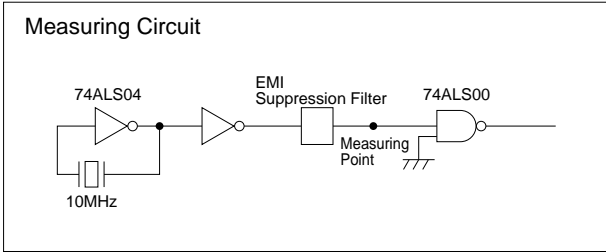

| Type of Filter | Signal Wave Form (20ns/div, 1V/div) | EMI Suppression Effect | Description |
|---|--|--|---|
| Signal Waveform and Noise Spectrum before Filter Mounting | Signal Waveform (20ns/div, 1V/div) | Noise Spectrum (10:1 Active Probe) | |
| NFW31S Series (Cut-off frequency 50MHz) | Signal Waveform (20ns/div, 1V/div) | Noise Level (dBμV) vs Frequency (MHz). Level before filter mounting is shown as a dashed line. | NFW31S's steep attenuation characteristic means excellent EMI suppression without waveform cornering. |
| Conventional Chip Solid Type EMI Filter (NFM41CC 470pF) | Signal Waveform (20ns/div, 1V/div) | Noise Level (dBμV) vs Frequency (MHz). Level before filter mounting is shown as a dashed line. | 3-terminal capacitors suppress signal frequencies as EMI frequencies so the signal waveform is distorted. |
| Filter Combined with Conventional LCs | Signal Waveform (20ns/div, 1V/div) | Noise Level (dBμV) vs Frequency (MHz). Level before filter mounting is shown as a dashed line. | Combinations of inductors and capacitors can yield a steep attenuation characteristic, but they require a great deal more mounting space. Moreover, at high frequencies the EMI suppression is less than that obtained by NFW31S. |

On-Board Type (DC) EMI Suppression Filters (EMIFIL®)



Chip EMIFIL® RC Combined Type NFR21G Series

NFR21G Series

NFR21G series is comprised of high performance EMI suppression filters which can suppress distortion of waveform. Various items are to be used, considering circuit impedance and noise condition.

■ Features

1. Murata's original inner design realizes small and low profile of 2.0x1.25x0.5mm.
2. Distributed constant circuit realizes smooth change of impedance which prevents reflection of signal and distortion of wave shape.
3. NFR21G series is effective in a line where ground is not stable, because the resistance element in the filter absorbs noise and returns it to ground line.
4. NFR21G series has no polarity so it can be used in dual direction transport lines.
5. NFR21G series has various lineups of resistance (22 to 100 ohm) and capacitance (10 to 100pF).

■ Applications

Interface lines and clock lines where signals tend to be distorted

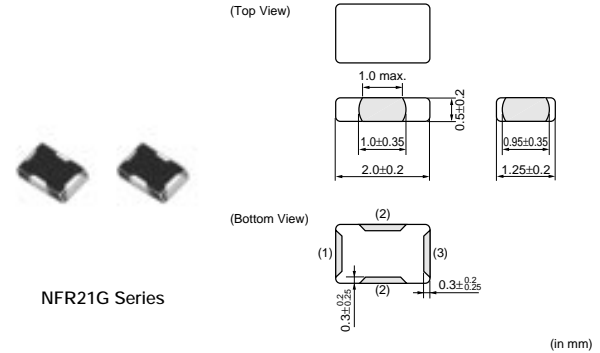

NFR21G Series

| Part Number | Capacitance (pF) | Resistance (ohm) | Rated Current (mA) | Rated Voltage (Vdc) | Insulation Resistance (M ohm) | Operating Temperature Range (°C) |
|----------------|------------------|------------------|--------------------|---------------------|-------------------------------|----------------------------------|
| NFR21GD1002202 | 10 +20%,-20% | 22 +30%,-30% | 50 | 50 | 1000 | -40 to 85 |
| NFR21GD1004702 | 10 +20%,-20% | 47 +30%,-30% | 35 | 50 | 1000 | -40 to 85 |
| NFR21GD4702202 | 47 +20%,-20% | 22 +30%,-30% | 50 | 50 | 1000 | -40 to 85 |
| NFR21GD4704702 | 47 +20%,-20% | 47 +30%,-30% | 35 | 50 | 1000 | -40 to 85 |
| NFR21GD4706802 | 47 +20%,-20% | 68 +30%,-30% | 30 | 50 | 1000 | -40 to 85 |
| NFR21GD4701012 | 47 +20%,-20% | 100 +30%,-30% | 25 | 50 | 1000 | -40 to 85 |
| NFR21GD1012202 | 100 +20%,-20% | 22 +30%,-30% | 50 | 50 | 1000 | -40 to 85 |
| NFR21GD1014702 | 100 +20%,-20% | 47 +30%,-30% | 35 | 50 | 1000 | -40 to 85 |
| NFR21GD1016802 | 100 +20%,-20% | 68 +30%,-30% | 30 | 50 | 1000 | -40 to 85 |
| NFR21GD1011012 | 100 +20%,-20% | 100 +30%,-30% | 25 | 50 | 1000 | -40 to 85 |

Number of Circuits: 1

■ Equivalent Circuit

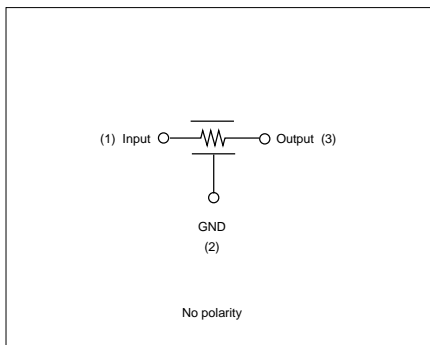

■ Insertion Loss Characteristics

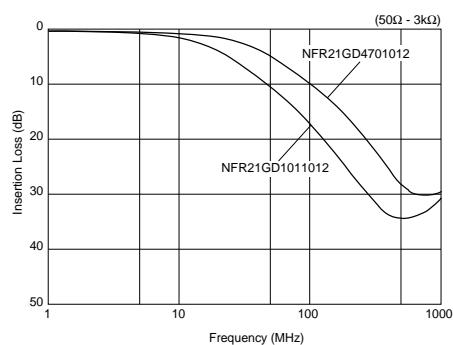
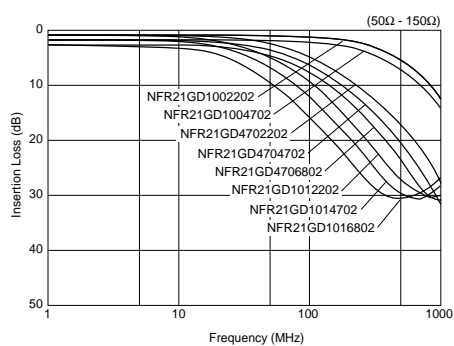

2

Noise Suppression Effect of NFR21G Series

■ Effect of Noise Suppression by NFR21G

NFR21G is effective even if ground line is not stable enough due to its distributed constant circuit structure.

Testing Circuit

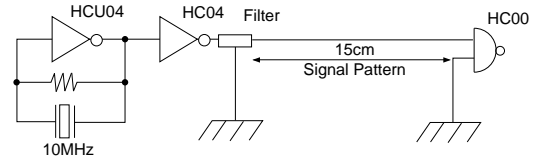

With Stable Ground Line

| Type of Filter | EMI Suppression Effect | Description |
|--|------------------------|---|
| Noise Level without Filter | | |
| Filter Mounting Condition Standard Type Chip EMIFIL® (100pF) | | The standard type chip EMIFIL® is effective on stable ground lines. |
| Filter Mounting Condition NFR21GD4701012 | | NFR21G has some advantages to standard type EMIFIL® on stable ground lines. |

With Poor Ground Line

| Type of Filter | EMI Suppression Effect | Description |
|--|------------------------|--|
| Noise Level without Filter | | |
| Filter Mounting Condition Standard Type Chip EMIFIL® (100pF) | | The standard type EMIFIL® loses efficiency on poor ground lines. |
| Filter Mounting Condition NFR21GD4701012 | | NFR21G is effective even on poor ground lines because of its distributed constant circuit structure and unique system to limit rush current. |

Noise Suppression Effect of NFR21G Series

■ Waveform Distortion Suppressing Function by NFR21G

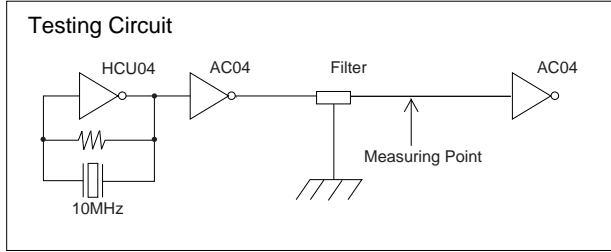

| Type of Filter | EMI Suppression Effect | Description |
|--|---|---|
| Initial Waveform (no filter) | <p>Voltage Waveform</p> <p>↑ :1V/div → :20ns/div</p> | <p>Resonance between the internal capacitance of the IC and the inductance of the print pattern causes waveform overshooting and undershooting.</p> |
| When Ordinary Capacitor Filter is Used | <p>Voltage Waveform</p> <p>↑ :1V/div → :20ns/div</p> | <p>Ordinary capacitor filters have no waveform distortion suppressing capability, and they cannot suppress disturbances in the waveforms.</p> |
| NFR21G | <p>Voltage Waveform</p> <p>↑ :1V/div → :20ns/div</p> | <p>The waveform distortion suppressing function of NFR21G minimizes disturbances of waveforms.</p> |

2

On-Board Type (DC) EMI Suppression Filters (EMIFIL®)



Chip EMIFIL® RC Combined Array Type NFA31G Series

NFA31G Series

NFA31G series is a high performance EMI suppression filter array with a 4-circuit noise filter in 3.2x1.6mm size. NFA31G realizes high density mounting.

■ Features

1. NFA31G is a 4-circuit noise filter in 3.2x1.6mm size with 0.8mm pitch. High density mounting is available.
2. Three terminal structure enables excellent high frequency performance.
3. Distributed constant circuit realizes smooth change of impedance which prevents reflection of signal and distortion of wave shape.
4. NFA31G series is effective in lines where ground is not stable, because the resistance element in the filter absorbs noise and returns it to ground line.



NFA31G Series

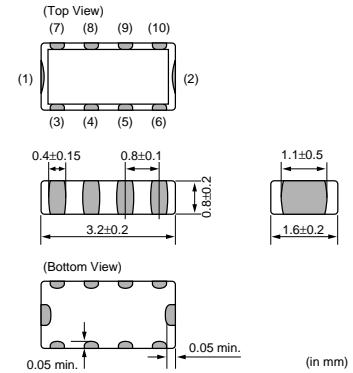

| Part Number | Capacitance (pF) | Resistance (ohm) | Rated Current (mA) | Rated Voltage (Vdc) | Insulation Resistance (M ohm) | Operating Temperature Range (°C) |
|----------------|------------------|------------------|--------------------|---------------------|-------------------------------|----------------------------------|
| NFA31GD1006R84 | 10 +20%,-20% | 6.8 +40%,-40% | 50 | 6 | 1000 | -40 to 85 |
| NFA31GD1004704 | 10 +20%,-20% | 47 +30%,-30% | 20 | 6 | 1000 | -40 to 85 |
| NFA31GD1001014 | 10 +20%,-20% | 100 +30%,-30% | 15 | 6 | 1000 | -40 to 85 |
| NFA31GD4706R84 | 47 +20%,-20% | 6.8 +40%,-40% | 50 | 6 | 1000 | -40 to 85 |
| NFA31GD4703304 | 47 +20%,-20% | 33 +30%,-30% | 20 | 6 | 1000 | -40 to 85 |
| NFA31GD4704704 | 47 +20%,-20% | 47 +30%,-30% | 20 | 6 | 1000 | -40 to 85 |
| NFA31GD4701014 | 47 +20%,-20% | 100 +30%,-30% | 15 | 6 | 1000 | -40 to 85 |
| NFA31GD1016R84 | 100 +20%,-20% | 6.8 +40%,-40% | 50 | 6 | 1000 | -40 to 85 |
| NFA31GD1014704 | 100 +20%,-20% | 47 +30%,-30% | 20 | 6 | 1000 | -40 to 85 |
| NFA31GD1011014 | 100 +20%,-20% | 100 +30%,-30% | 15 | 6 | 1000 | -40 to 85 |

Number of Circuits: 4

■ Equivalent Circuit

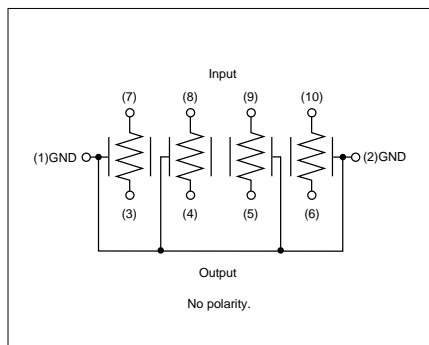

■ Insertion Loss Characteristics

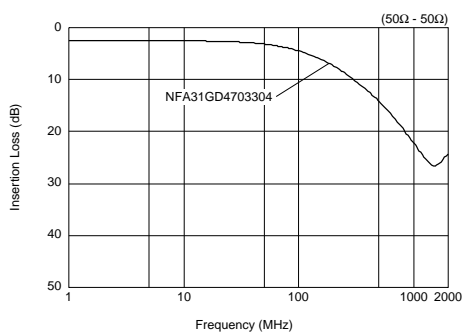
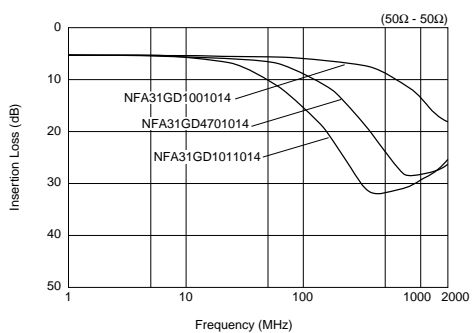
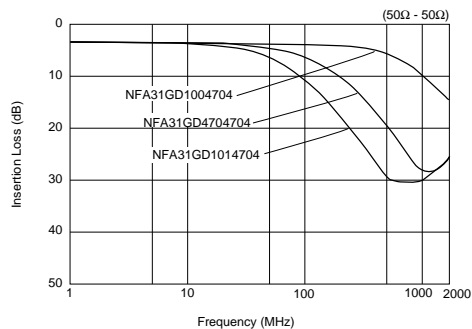
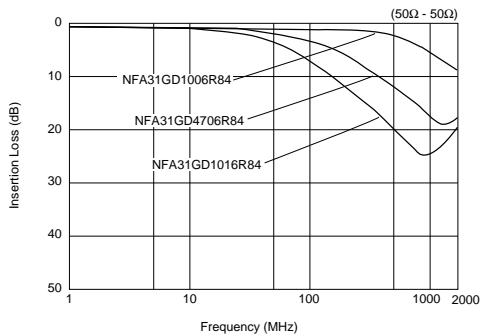

2

On-Board Type (DC) EMI Suppression Filters (EMIFIL®)



Chip EMIFIL® for Large Current NFM18P/21P/3DP/31P/41P/55P Series

NFM18PS Series

■ Features

1. Excellent noise suppression characteristics in high frequency band.
2. Rated current of 2A is achieved in small size of 1.6x0.8mm.
3. Suitable for noise suppression in IC power line.

■ Applications

For IC power lines of digital equipment such as DVDs, DSCs, Mobile Phones, Digital TVs

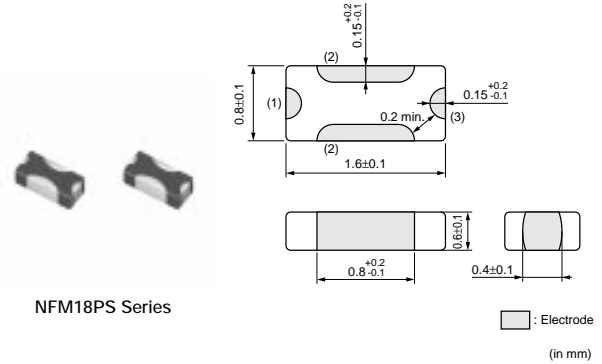

NFM18PS Series

| Part Number | Capacitance (μF) | Rated Voltage (Vdc) | Rated Current (A) | Insulation Resistance (min.) (M ohm) | Operating Temperature Range (°C) |
|----------------|------------------|---------------------|-------------------|--------------------------------------|----------------------------------|
| NFM18PS474R0J3 | 0.47 +20%,-20% | 6.3 | 2 | 1000 | -55 to +125 |
| NFM18PS105R0J3 | 1.0 +20%,-20% | 6.3 | 2 | 500 | -55 to +105 |

■ Equivalent Circuit

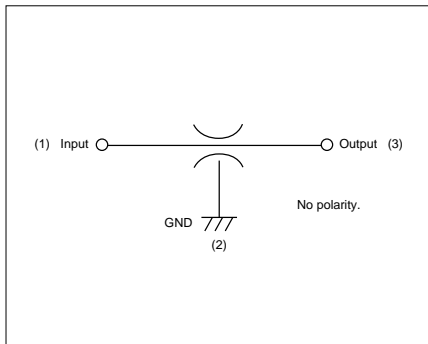

■ Insertion Loss Characteristics

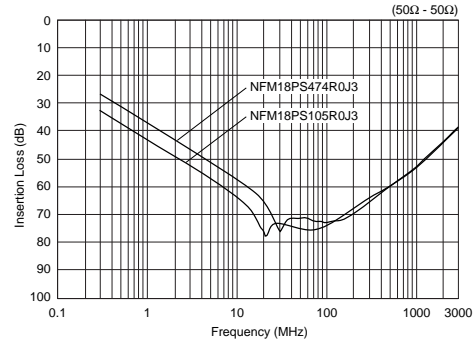

NFM18PC Series

NFM18PC series is a high performance EMI suppression filter in 1.6x0.8mm size for high-speed IC power supply lines by using Murata processing technology.

■ Features

1. Ultra-small size in 1.6x0.8mm
2. Three terminal structure with low residual (ESL)* and large capacitance 2.2 micro F (max.) realize large insertion loss characteristics over wide frequency range.
3. Large rated current 4A max. is suitable for noise suppression of circuits which require large current.
4. NFM18PC series has line up of capacitance 0.1 to 2.2 micro F.

* Not exceeding one-tenth of monolithic ceramic capacitors (two terminal).

■ Applications

1. Noise suppression for large capacitance circuits such as high speed IC power lines
2. Control change of voltage for high speed IC

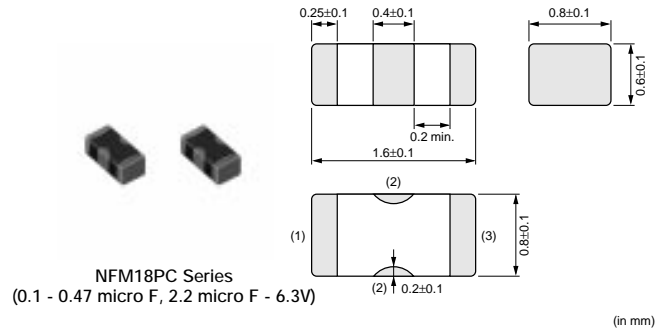
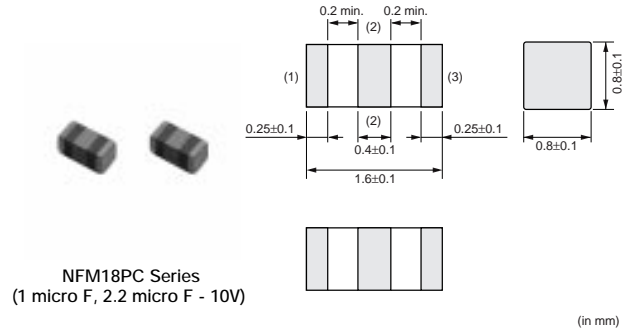

| Part Number | Capacitance (μF) | Rated Voltage (Vdc) | Rated Current (A) | Insulation Resistance (min.) (M ohm) | Operating Temperature Range (°C) |
|----------------|------------------|---------------------|-------------------|--------------------------------------|----------------------------------|
| NFM18PC104R1C3 | 0.1 +20%, -20% | 16 | 2 | 1000 | -55 to +125 |
| NFM18PC224R0J3 | 0.22 +20%, -20% | 6.3 | 2 | 1000 | -55 to +125 |
| NFM18PC474R0J3 | 0.47 +20%, -20% | 6.3 | 2 | 1000 | -55 to +125 |
| NFM18PC105R0J3 | 1.0 +20%, -20% | 6.3 | 2 | 500 | -55 to +105 |
| NFM18PC225B0J3 | 2.2 +20%, -20% | 6.3 | 2 | 200 | -40 to +85 |
| NFM18PC225B1A3 | 2.2 +20%, -20% | 10 | 4 | 200 | -40 to +85 |

■ Equivalent Circuit

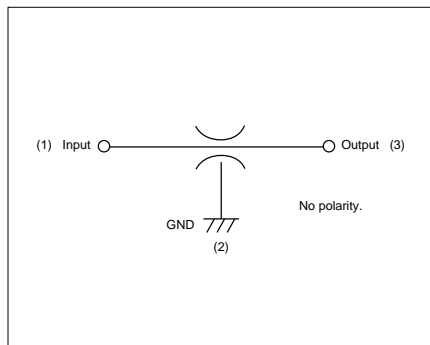

■ Insertion Loss Characteristics

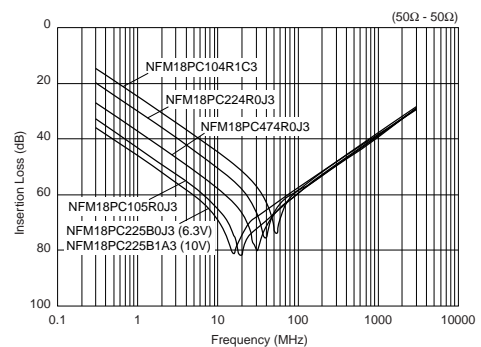

NFM21P Series

NFM21P is a three terminal structure component. This product can be applied to large current DC power lines. NFM21P is suitable for noise suppression of DC power lines where relatively large current operates.

■ Features

1. The rated current of 6A max. is suitable for IC's individual power lines.
2. Small dimension enables higher density packaging. NFM21P is much smaller size (2.0x1.25x0.85mm).
3. Murata's original internal electrode structure design realizes excellent EMI suppression effects from low frequency to high frequency.

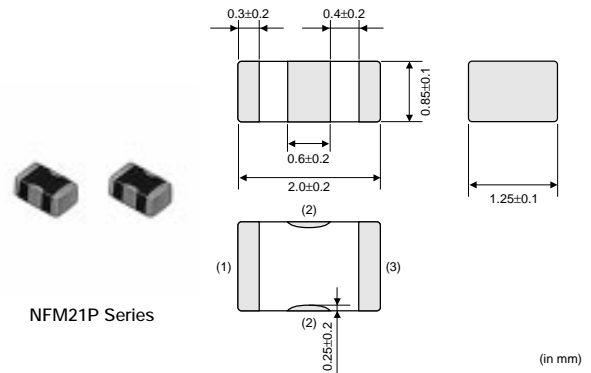

NFM21P Series

2

| Part Number | Capacitance (μF) | Rated Voltage (Vdc) | Rated Current (A) | Insulation Resistance (min.) (M ohm) | Operating Temperature Range (°C) |
|----------------|------------------|---------------------|-------------------|--------------------------------------|----------------------------------|
| NFM21PC104R1E3 | 0.1 +20%, -20% | 25 | 2 | 1000 | -55 to +125 |
| NFM21PC224R1C3 | 0.22 +20%, -20% | 16 | 2 | 1000 | -55 to +125 |
| NFM21PC474R1C3 | 0.47 +20%, -20% | 16 | 2 | 1000 | -55 to +125 |
| NFM21PC105B1A3 | 1.0 +20%, -20% | 10 | 4 | 500 | -40 to +85 |
| NFM21PC105B1C3 | 1.0 +20%, -20% | 16 | 4 | 500 | -40 to +85 |
| NFM21PC225B0J3 | 2.2 +20%, -20% | 6.3 | 4 | 200 | -40 to +85 |
| NFM21PC475B1A3 | 4.7 +20%, -20% | 10 | 6 | 100 | -40 to +85 |

■ Equivalent Circuit

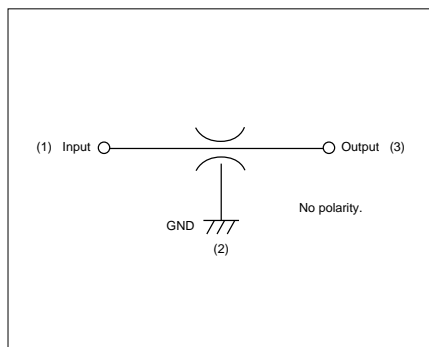

■ Insertion Loss Characteristics

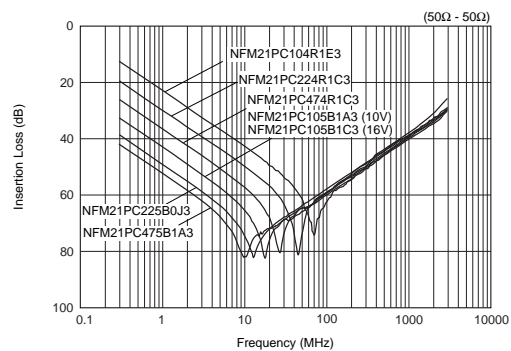

NFM3DP Series

The chip "EMIFIL" NFM3DP is a chip type three terminal capacitor with high rated current of 2A. This series is suited for noise suppression in DC power supply lines of digital instruments.

■ Features

1. Large rated current (2A) is suitable for application in DC power lines.
2. Small size (3.2x1.25mm) and low profile (0.7mm max.)

■ Applications

1. Personal computers, word processors and peripherals
2. Telephones, PPCs, communication equipment, etc.
3. Digital TVs, DVDs
4. Telecommunications equipment

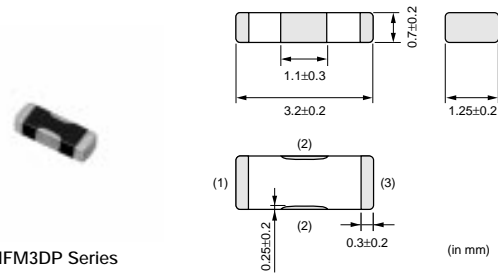

NFM3DP Series

| Part Number | Capacitance (μF) | Rated Voltage (Vdc) | Rated Current (A) | Insulation Resistance (min.) (M ohm) | Operating Temperature Range (°C) |
|-----------------------|------------------|---------------------|-------------------|--------------------------------------|----------------------------------|
| NFM3DPC223R1H3 | 0.022 +20%,-20% | 50 | 2 | 1000 | -55 to +125 |

In operating temperatures exceeding +85°C, derating of current is necessary.

■ Equivalent Circuit

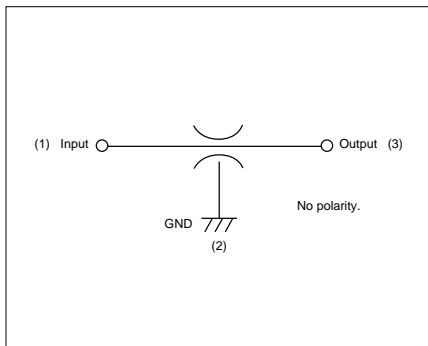

■ Insertion Loss Characteristics

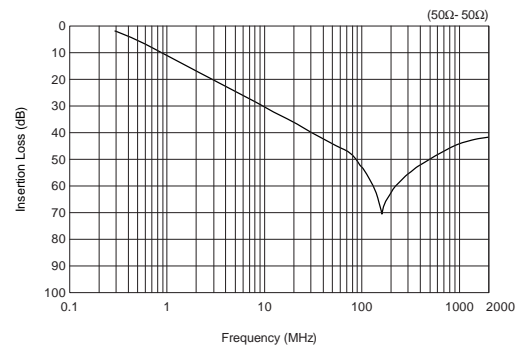

■ Notice (Rating)

When NFM3DP series is used in operating temperatures exceeding +85°C, derating of current is necessary. Please apply the derating curve shown in chart according to the operating temperature.

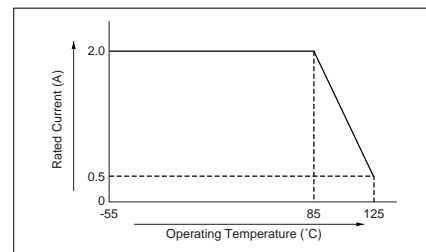

NFM31P Series

NFM31P series is EMI suppression filter for power lines of high speed IC with high capacitance (27uF) and large rated current (6A) in 3.2x1.6mm chip size, which is realized using Murata's high level multilayer processing technology.

■ Feature

1. Low ESL characteristics and high capacitance of 27uF due to its 3-terminal structure, realizes high noise suppression effect from low frequency to high frequency.
It is suitable as decoupling capacitor for broad frequency range.
2. Large rated current of 6A is suitable for noise suppression in power lines of high speed IC which need large current capacity.

■ Application

1. EMI suppression for high noise level circuit which need large current capacity such as IC power lines.
2. Stabilization of power line voltage in high speed ICs.

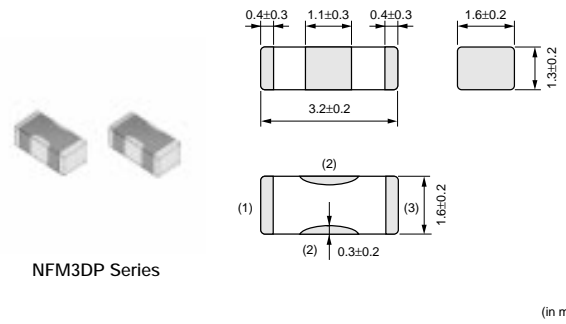

2

| Part Number | Capacitance (μF) | Rated Voltage (Vdc) | Rated Current (A) | Insulation Resistance (min.) (M ohm) | Operating Temperature Range (°C) |
|-----------------------|------------------|---------------------|-------------------|--------------------------------------|----------------------------------|
| NFM31PC276B0J3 | 27 +20%,-20% | 6.3 | 6 | 20 | -40 to +85 |

■ Equivalent Circuit

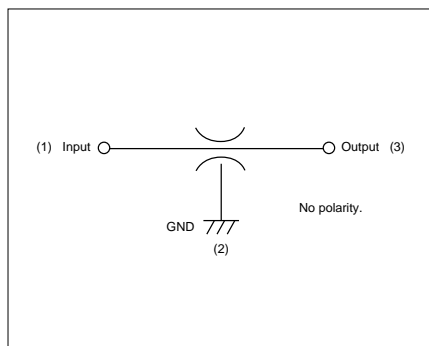

■ Insertion Loss Characteristics

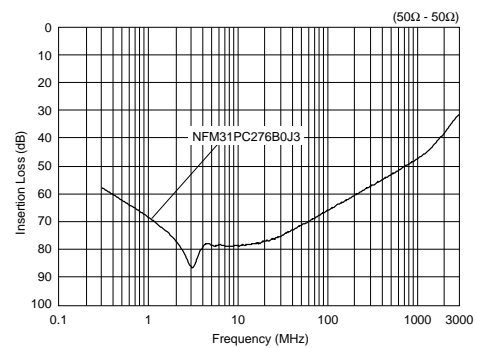

NFM41P Series

The chip "EMIFIL" NFM41P series consists of three terminal structure. These components are able to be applied to large current DC power lines. NFM41P series are suitable in noise suppression in DC lines where relatively large currents operate.

■ Features

1. Large rated current 6A (max.) is suitable for the application in DC power lines.
2. High electrostatic capacitance and remarkable high frequency performance are effective for immunity against surge noise and pulse noise.

■ Applications

1. Personal computers, word processors and peripherals
2. Telephones, PPCs, communication equipment, etc.
3. Digital TVs, DVDs
4. Telecommunications equipment

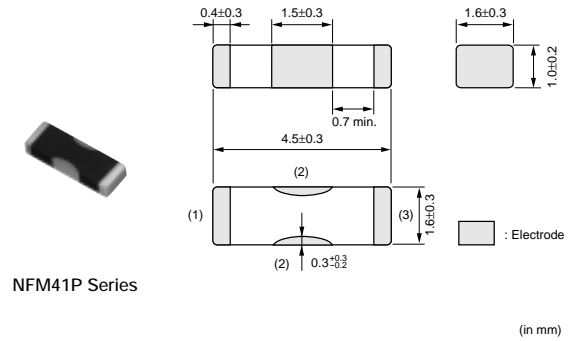

NFM41P Series

| Part Number | Capacitance (μF) | Rated Voltage (Vdc) | Rated Current (A) | Insulation Resistance (min.) (M ohm) | Operating Temperature Range (°C) |
|-----------------------|------------------|---------------------|-------------------|--------------------------------------|----------------------------------|
| NFM41PC204F1H3 | 0.2 +80%, -20% | 50 | 2 | 1000 | -55 to +85 |
| NFM41PC155B1E3 | 1.5 +20%, -20% | 25 | 6 | 300 | -55 to +85 |

■ Equivalent Circuit

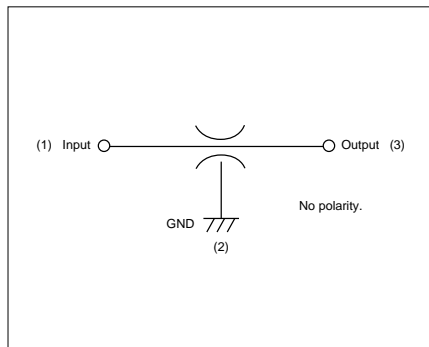

■ Insertion Loss Characteristics

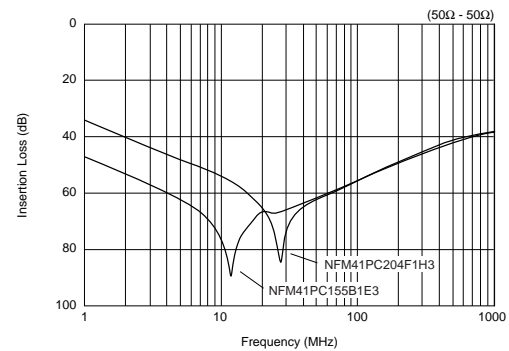

NFM55P Series

The chip solid "EMIFIL" NFM55P is a chip type three terminal capacitor with high rated current of 6A. This series is suited for noise suppression in DC power lines where high rated current and large capacitance is required.

■ Features

1. Large rated current (6A) and low voltage drop due to a small DC resistance (0.01 ohm) are suitable for the application in DC power line.
2. High electrostatic capacitance and remarkable high frequency performance are effective for the immunity against the surge noise and the pulse noise.
3. Only reflow soldering should be applied.

■ Applications

1. Personal computers, word processors and peripherals
2. Telephones, PPCs, communication equipment, etc.
3. Digital TVs, DVDs
4. Telecommunications equipment

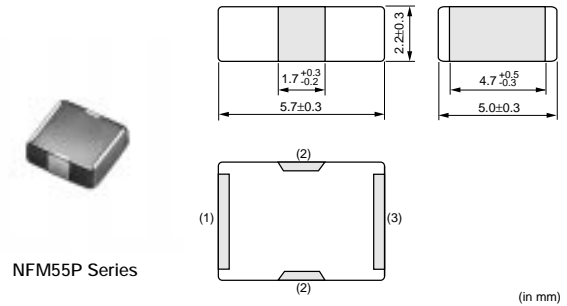

2

| Part Number | Capacitance (μF) | Rated Voltage (Vdc) | Rated Current (A) | Insulation Resistance (min.) (M ohm) | Operating Temperature Range (°C) |
|----------------|------------------|---------------------|-------------------|--------------------------------------|----------------------------------|
| NFM55PC155F1H4 | 1.5 +80%, -20% | 50 | 6 | 100 | -55 to +85 |

■ Equivalent Circuit

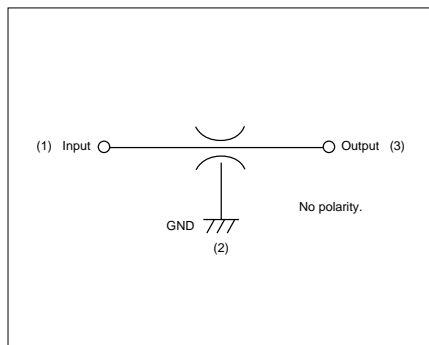

■ Insertion Loss Characteristics

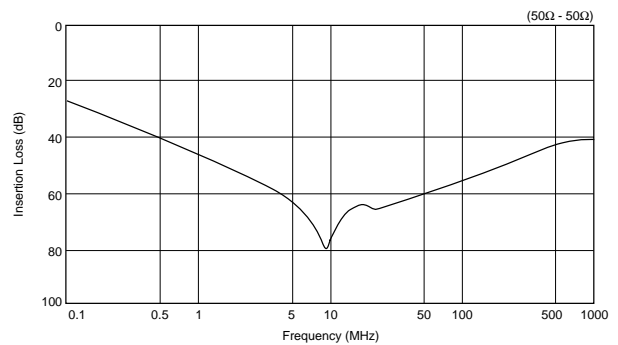

On-Board Type (DC) EMI Suppression Filters (EMIFIL®)



Chip EMIFIL® LC Combined Type for Large Current NFE31P/61P Series

NFE31P Series

The chip "EMIFIL" NFE31P is a small size T-type circuit EMI suppression filter.

■ Features

1. Its large rated current of 6A and low voltage drop due to small DC resistance are suitable for DC power line use.
2. The feedthrough capacitor realizes excellent high frequency characteristics.
3. The structure incorporates built-in ferrite beads which minimize resonance with surrounding circuits.
4. 22 to 2,200pF lineups can be used in signal lines.

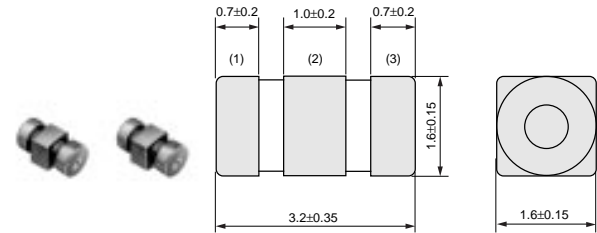

NFE31P Series

(in mm)

2

| Part Number | Capacitance (pF) | Rated Voltage (Vdc) | Rated Current (A) | Insulation Resistance (min.) (M ohm) | Operating Temperature Range (°C) |
|----------------|------------------|---------------------|-------------------|--------------------------------------|----------------------------------|
| NFE31PT220R1E9 | 22 +30%, -30% | 25 | 6 | 1000 | -40 to +85 |
| NFE31PT470C1E9 | 47 +50%, -20% | 25 | 6 | 1000 | -40 to +85 |
| NFE31PT101C1E9 | 100 +80%, -20% | 25 | 6 | 1000 | -40 to +85 |
| NFE31PT221D1E9 | 220 +50%, -20% | 25 | 6 | 1000 | -40 to +85 |
| NFE31PT471F1E9 | 470 +50%, -20% | 25 | 6 | 1000 | -40 to +85 |
| NFE31PT152Z1E9 | 1500 +50%, -20% | 25 | 6 | 1000 | -40 to +85 |
| NFE31PT222Z1E9 | 2200 +50%, -50% | 25 | 6 | 1000 | -40 to +85 |

■ Equivalent Circuit

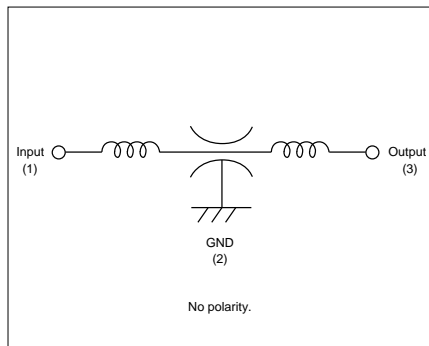

■ Insertion Loss Characteristics

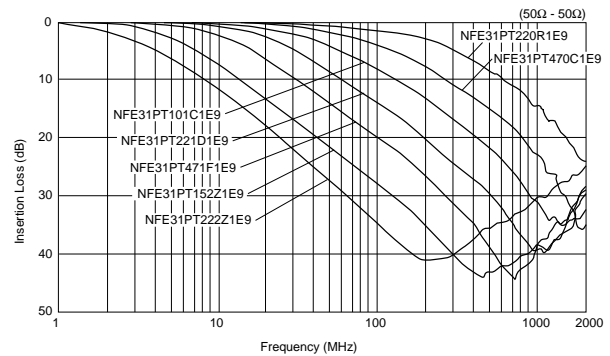

NFE61P Series

The chip "EMIFIL" NFE61P is a T-type circuit EMI suppression filter.

■ Features

1. Its large rated current of 2A and low voltage drop due to small DC resistance are suitable for DC power line use.
2. The feedthrough capacitor realizes excellent high frequency characteristics.
3. The structure incorporates built-in ferrite beads which minimize resonance with surrounding circuits.
4. 33 to 4,700pF lineups can be used in signal lines.

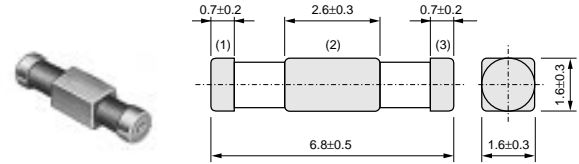

NFE61P Series

(in mm)

2

| Part Number | Capacitance (pF) | Rated Voltage (Vdc) | Rated Current (A) | Insulation Resistance (min.) (M ohm) | Operating Temperature Range (°C) |
|----------------|------------------|---------------------|-------------------|--------------------------------------|----------------------------------|
| NFE61PT330B1H9 | 33 +30%, -30% | 50 | 2 | 1000 | -25 to +85 |
| NFE61PT680B1H9 | 68 +30%, -30% | 50 | 2 | 1000 | -25 to +85 |
| NFE61PT101Z1H9 | 100 +30%, -30% | 50 | 2 | 1000 | -25 to +85 |
| NFE61PT181B1H9 | 180 +30%, -30% | 50 | 2 | 1000 | -25 to +85 |
| NFE61PT361B1H9 | 360 +20%, -20% | 50 | 2 | 1000 | -25 to +85 |
| NFE61PT681B1H9 | 680 +30%, -30% | 50 | 2 | 1000 | -25 to +85 |
| NFE61PT102E1H9 | 1000 +80%, -20% | 50 | 2 | 1000 | -25 to +85 |
| NFE61PT472C1H9 | 4700 +80%, -20% | 50 | 2 | 1000 | -25 to +85 |

■ Equivalent Circuit

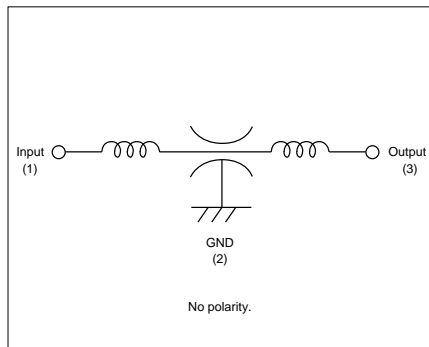

■ Insertion Loss Characteristics

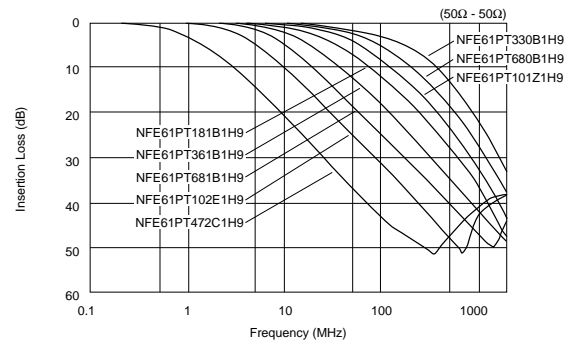

On-Board Type (DC) EMI Suppression Filters (EMIFIL®)



Chip Common Mode Choke Coils Part Numbering

Chip Common Mode Choke Coils

(Part Number)

| | | | | | | | | | |
|----|---|----|---|---|-----|---|---|---|---|
| DL | W | 21 | S | N | 371 | S | Q | 2 | L |
| ① | ② | ③ | ④ | ⑤ | ⑥ | ⑦ | ⑧ | ⑨ | ⑩ |

① Product ID

| Product ID | |
|------------|------------------------------|
| DL | Chip Common Mode Choke Coils |

② Structure

| Code | Structure |
|------|-----------------|
| W | Winding Type |
| M | Monolithic Type |
| P | Film Type |

③ Dimensions (L×W)

| Code | Dimensions (L×W) | EIA |
|------|------------------|-------|
| 0N | 0.85×0.65mm | 03025 |
| 11 | 1.25×1.0mm | 0504 |
| 21 | 2.0×1.2mm | 0805 |
| 31 | 3.2×1.6mm | 1206 |
| 2A | 2.0×1.0mm | 0804 |
| 2H | 2.5×2.0mm | 1008 |
| 5A | 5.0×3.6mm | 2014 |
| 5B | 5.0×5.0mm | 2020 |

④ Type

| Code | Type |
|------|--|
| S | Magnetically Shielded One Circuit Type |
| D | Magnetically Shielded Two Circuit Type |
| H | Open Magnetic One Circuit Type |
| G | Magnetically Monolithic Type (sectional winding) |
| T | Magnetically Shielded One Circuit Low Profile Type |

⑩ Packaging

| Code | Packaging | Series |
|------|-------------------------------|-----------------------------|
| K | Embossed Taping (ø330mm Reel) | DLW5AH/DLW5BS/DLW5BT |
| L | Embossed Taping (ø180mm Reel) | All Series |
| B | Bulk | All Series |

⑤ Category

| Code | Category |
|------|------------------------|
| A | Expressed by a letter. |
| N | |
| R | |

⑥ Impedance

Typical impedance at 100MHz is expressed by three figures. The unit is in ohm (Ω). The first and second figures are significant digits, and the third figure expresses the number of zeros which follow the two figures.

⑦ Circuit

| Code | Circuit |
|------|------------------------|
| S | Expressed by a letter. |
| M | |
| H | |

⑧ Features

| Code | Features |
|------|------------------------|
| L | Expressed by a letter. |
| Q | |
| Z | |

⑨ Number of Signal Lines

| Code | Number of Signal Lines |
|------|------------------------|
| 2 | Two Lines |
| 3 | Three Lines |
| 4 | Four Lines |

3

On-Board Type (DC) EMI Suppression Filters (EMIFIL®)



Chip Common Mode Choke Coils Film Type DLP0NS/11S/31S Series

DLP0NS Series

■ Features

1. Small size and tight dimensional tolerance
Size: 0.85x0.65x0.45mm Tolerance: +-0.05mm
2. Useful impedance line-up from 67 ohm to 120 ohm
3. DLP0NS series enables noise suppression for differential signal line without distortion in high-speed signal transmission due to its line impedance matching

■ Applications

Common mode noise suppression of high speed differential signal lines for USB 2.0, IEEE1394, LVDS

1. Note PCs
2. Cellular phones
3. Digital Still Cameras, Digital Video Cameras

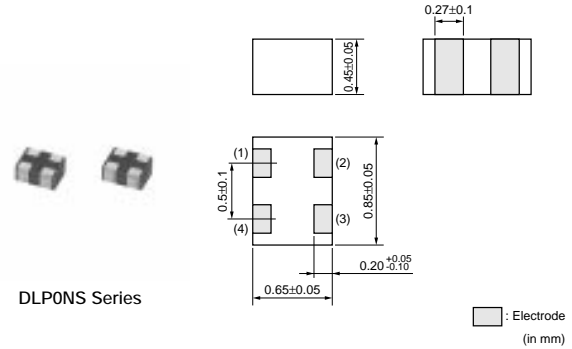

DLP0NS Series

3

| Part Number | Common Mode Impedance (at 100MHz/20 degree C) (ohm) | Rated Current (mA) | Rated Voltage (Vdc) | Insulation Resistance (min.) (M ohm) | Withstand Voltage (Vdc) | DC Resistance (ohm) |
|---------------|---|--------------------|---------------------|--------------------------------------|-------------------------|---------------------|
| DLP0NSN670HL2 | 67 ±20% | 110 | 5 | 100 | 12.5 | 2.4 ±25% |
| DLP0NSN900HL2 | 90 ±20% | 100 | 5 | 100 | 12.5 | 3.0 ±25% |
| DLP0NSN121HL2 | 120 ±20% | 90 | 5 | 100 | 12.5 | 3.8 ±25% |

Operating Temperature Range: -40°C to 85°C

■ Equivalent Circuit

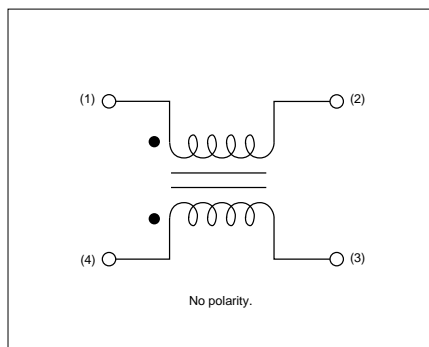

■ Impedance - Frequency

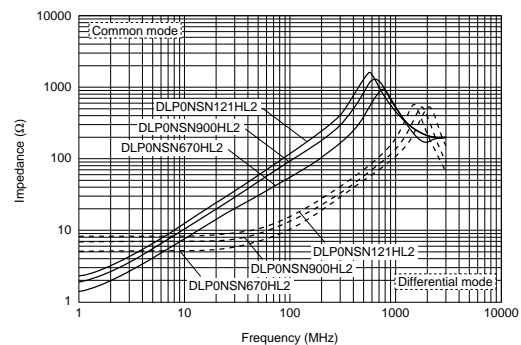

Continued on the following page. ↗

Continued from the preceding page.

Transmission Characteristics (Typical)

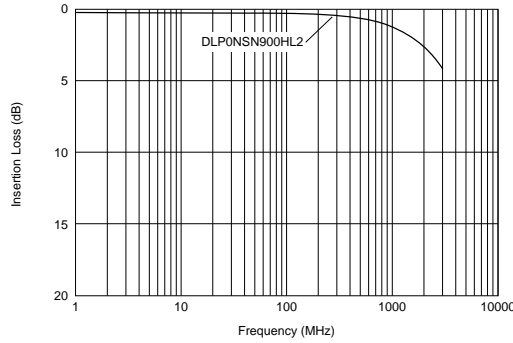

DLP11S Series

Features

1. Small size and tight dimensional tolerance
Size: 1.25x1.0x0.82mm Tolerance: ± 0.1 mm
2. Useful impedance line-up from 67 ohm to 330 ohm
3. DLP11S series enables noise suppression for differential signal line without distortion in high-speed signal transmission due to its high coupling
4. DLP11SN_HL2, DLP11SA series match with line impedance
5. High Cutoff Frequency is suitable for high speed differential signal line such as HDMI.
Cutoff Frequency: 6GHz (DLP11SA series)

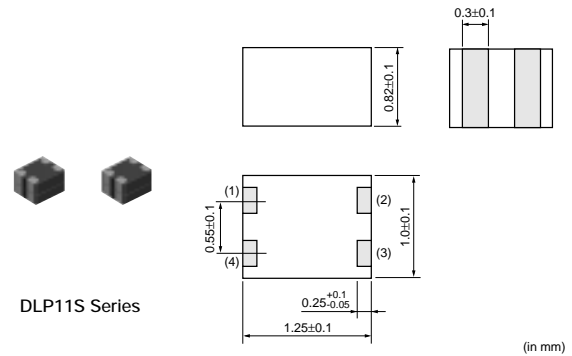

Applications

Common mode noise suppression of high speed differential signal lines for USB, IEEE1394, LVDS

1. Note PCs, PDAs
2. Cellular phones
3. Digital Still Cameras, Digital Video Cameras

| Part Number | Common Mode Impedance (at 100MHz/20 degree C) (ohm) | Rated Current (mA) | Rated Voltage (Vdc) | Insulation Resistance (min.) (M ohm) | Withstand Voltage (Vdc) | DC Resistance (ohm) |
|---------------|---|-----------------------|------------------------|--|----------------------------|------------------------|
| DLP11SA350HL2 | 35 $\pm 20\%$ | 170 | 5 | 100 | 12.5 | 0.9 $\pm 25\%$ |
| DLP11SA670HL2 | 67 $\pm 20\%$ | 150 | 5 | 100 | 12.5 | 1.2 $\pm 25\%$ |
| DLP11SN670SL2 | 67 $\pm 20\%$ | 180 | 5 | 100 | 12.5 | 1.3 $\pm 25\%$ |
| DLP11SA900HL2 | 90 $\pm 20\%$ | 150 | 5 | 100 | 12.5 | 1.4 $\pm 25\%$ |
| DLP11SN900HL2 | 90 $\pm 20\%$ | 150 | 5 | 100 | 12.5 | 1.5 $\pm 25\%$ |
| DLP11SN121SL2 | 120 $\pm 20\%$ | 140 | 5 | 100 | 12.5 | 2.0 $\pm 25\%$ |
| DLP11SN161SL2 | 160 $\pm 20\%$ | 120 | 5 | 100 | 12.5 | 2.7 $\pm 25\%$ |
| DLP11SN201HL2 | 200 $\pm 20\%$ | 110 | 5 | 100 | 12.5 | 3.1 $\pm 25\%$ |
| DLP11SN241HL2 | 240 $\pm 20\%$ | 100 | 5 | 100 | 12.5 | 3.5 $\pm 25\%$ |
| DLP11SN281HL2 | 280 $\pm 20\%$ | 90 | 5 | 100 | 12.5 | 4.2 $\pm 25\%$ |
| DLP11SN331HL2 | 330 $\pm 20\%$ | 80 | 5 | 100 | 12.5 | 4.9 $\pm 25\%$ |

Operating Temperature Range: -40°C to 85°C

Equivalent Circuit

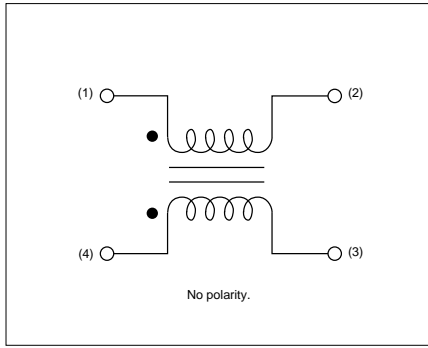

Impedance - Frequency

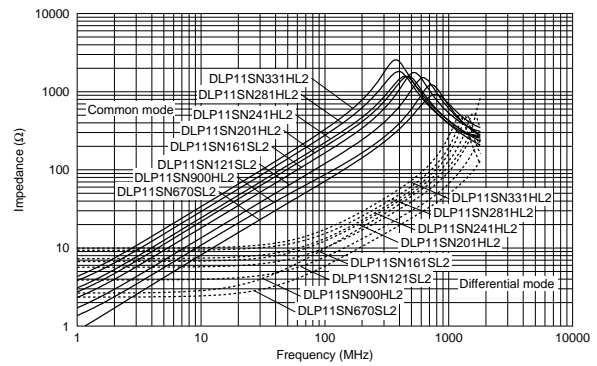
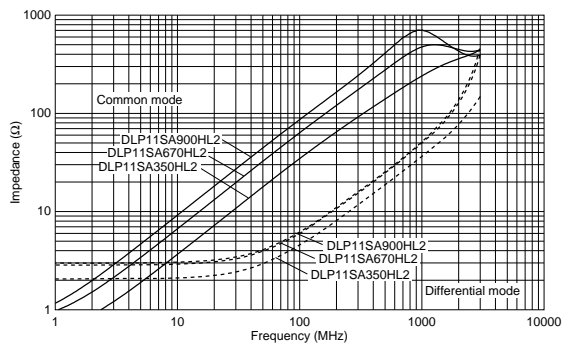

3

Transmission Characteristics (Typical)

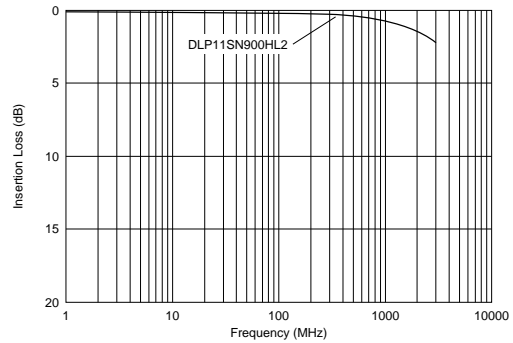
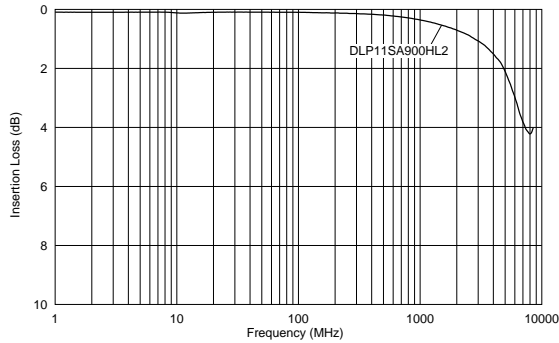

DLP31S Series

DLP31S series is chip common mode choke coil that realizes high impedance in a small size with ferrite material technology and film processing technology. DLP31S series has excellent performance at high frequency range. It is suitable for differential signal line application.

■ Features

1. Small size, low profile, SMD. 3.2x1.6x1.15mm (Tolerance: ± 0.15 mm)
2. High common mode impedance (550 ohm at 100MHz typ.) in small size
3. DLP31S suppresses high frequency noise that was unable to be suppressed with existing common mode choke coils. Suitable for differential signal lines like USB, because DLP31S does not provide distortion to high speed signal transmission due to its high coupling (coupling coefficient: 0.98 min.)

■ Applications

1. USB lines of PCs, peripheral equipment
2. LVDS lines of Note-PCs, LCDs
3. USB lines of digital AV equipment such as digital cameras

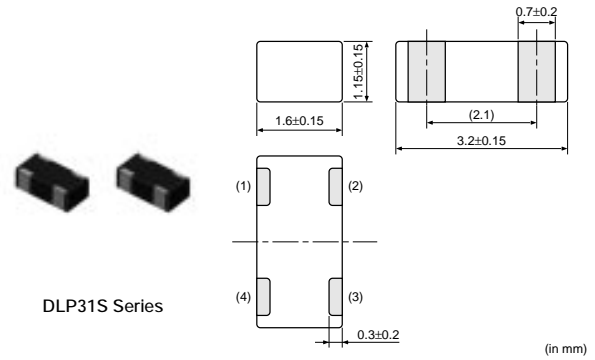

| Part Number | Common Mode Impedance (at 100MHz/20 degree C) (ohm) | Rated Current (mA) | Rated Voltage (Vdc) | Insulation Resistance (min.) (M ohm) | Withstand Voltage (Vdc) | DC Resistance (ohm) |
|---------------|---|--------------------|---------------------|--------------------------------------|-------------------------|---------------------|
| DLP31SN121ML2 | 120 $\pm 20\%$ | 100 | 16 | 100 | 40 | 2.0 max. |
| DLP31SN221ML2 | 220 $\pm 20\%$ | 100 | 16 | 100 | 40 | 2.5 max. |
| DLP31SN551ML2 | 550 $\pm 20\%$ | 100 | 16 | 100 | 40 | 3.6 max. |

Operating Temperature Range: -40°C to 85°C

■ Equivalent Circuit

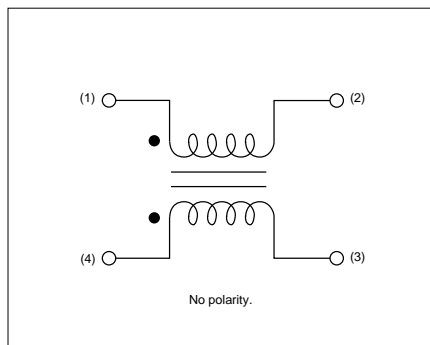

■ Impedance - Frequency

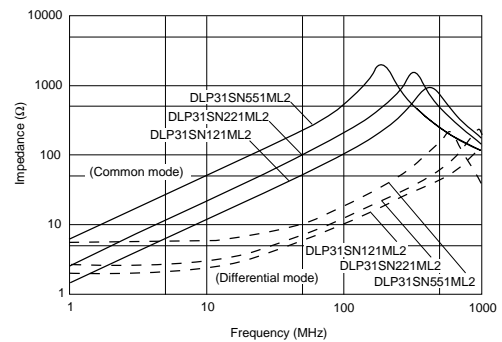

On-Board Type (DC) EMI Suppression Filters (EMIFIL®)



Chip Common Mode Choke Coils Arrays Film Type DLP2AD/31D Series

DLP2AD Series

■ Features

- 2 components are included in 2.0x1.0mm size
- Low profile: typ. 0.82mm
- High common mode impedance characteristics (max. 280 ohm, at 100MHz)
- DLP2AD can suppress common mode noise without damage to signal wave.
- DLP2AD match with line impedance.

■ Applications

Common mode noise suppression of high speed differential signal lines for USB, IEEE1394 LVDS, DVI, HDMI

- Main board of personal computers, Note PCs
- Printers, Scanners
- LCD monitors
- Game equipment
- PC peripheral equipment

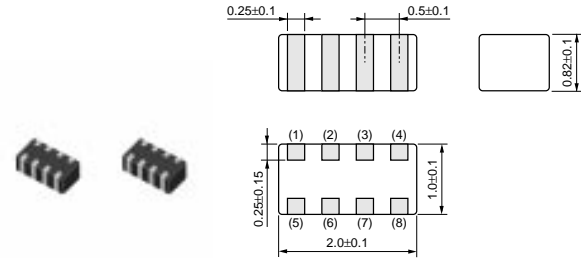

DLP2AD Series

(in mm)

3

| Part Number | Common Mode Impedance (at 100MHz/20 degree C) (ohm) | Rated Current (mA) | Rated Voltage (Vdc) | Insulation Resistance (min.) (M ohm) | Withstand Voltage (Vdc) | DC Resistance (ohm) |
|---------------|---|--------------------|---------------------|--------------------------------------|-------------------------|---------------------|
| DLP2ADN670HL4 | 67 ±20% | 140 | 5 | 100 | 12.5 | 1.3 ±25% |
| DLP2ADN900HL4 | 90 ±20% | 130 | 5 | 100 | 12.5 | 1.7 ±25% |
| DLP2ADN121HL4 | 120 ±20% | 120 | 5 | 100 | 12.5 | 2.0 ±25% |
| DLP2ADN161HL4 | 160 ±20% | 100 | 5 | 100 | 12.5 | 2.5 ±25% |
| DLP2ADN201HL4 | 200 ±20% | 90 | 5 | 100 | 12.5 | 3.2 ±25% |
| DLP2ADN241HL4 | 240 ±20% | 80 | 5 | 100 | 12.5 | 3.8 ±25% |
| DLP2ADN281HL4 | 280 ±20% | 80 | 5 | 100 | 12.5 | 4.6 ±25% |

Operating Temperature Range: -40°C to 85°C

■ Equivalent Circuit

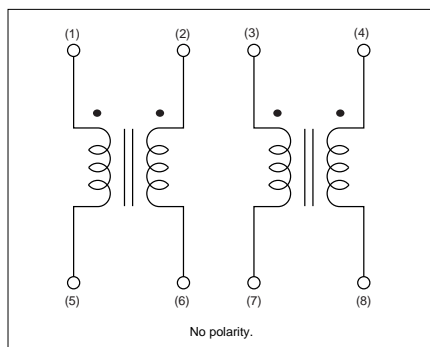

■ Impedance - Frequency

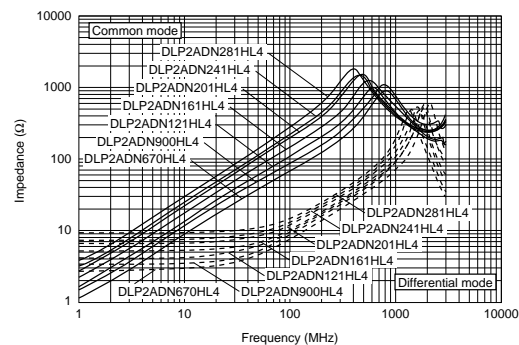

Continued on the following page. ↗

Continued from the preceding page.

Transmission Characteristics (Typical)

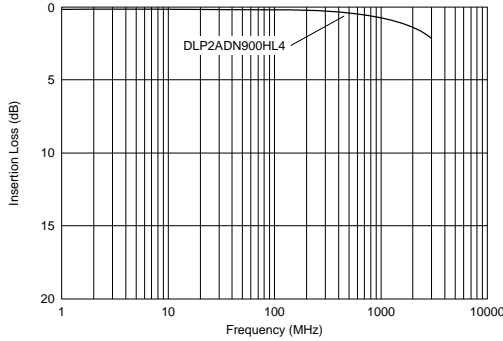

DLP31D Series

DLP31D series is chip common mode choke coil array which realizes high coupling and high impedance in a small size with ferrite material technology and thin film processing technology.

Features

- 2 components included in 3.2x1.6mm
- Thin type 1.15mm
- High common mode Impedance characteristics (max. 440 ohm, at 100MHz)
- DLP31D can suppress common mode noise without damage to signal wave.

Applications

Common mode noise suppression of high speed differential signal lines for USB, IEEE1394, LVDS

- Main board of personal computers, note PCs
- Printers, Scanners
- LCD monitors
- Game equipment
- PC peripheral equipment

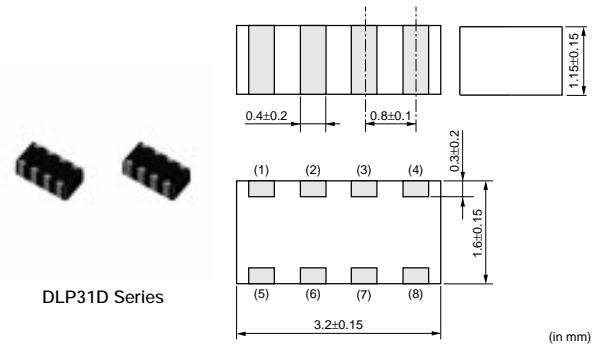

DLP31D Series

3

| Part Number | Common Mode Impedance (at 100MHz/20 degree C) (ohm) | Rated Current (mA) | Rated Voltage (Vdc) | Insulation Resistance (min.) (M ohm) | Withstand Voltage (Vdc) | DC Resistance (ohm) |
|---------------|---|--------------------|---------------------|--------------------------------------|-------------------------|---------------------|
| DLP31DN900ML4 | 90 ±20% | 160 | 10 | 100 | 25 | 1.1 max. |
| DLP31DN131ML4 | 130 ±20% | 120 | 10 | 100 | 25 | 1.6 max. |
| DLP31DN201ML4 | 200 ±20% | 100 | 10 | 100 | 25 | 2.2 max. |
| DLP31DN321ML4 | 320 ±20% | 80 | 10 | 100 | 25 | 3.5 max. |
| DLP31DN441ML4 | 440 ±20% | 70 | 10 | 100 | 25 | 4.3 max. |

Operating Temperature Range: -40°C to 85°C

■ Equivalent Circuit

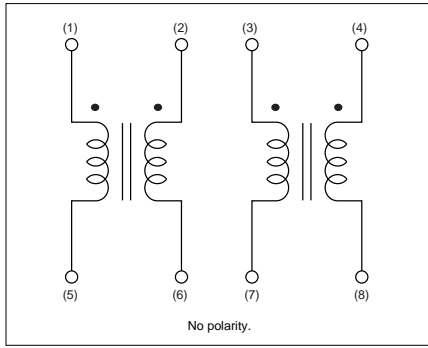

■ Impedance - Frequency

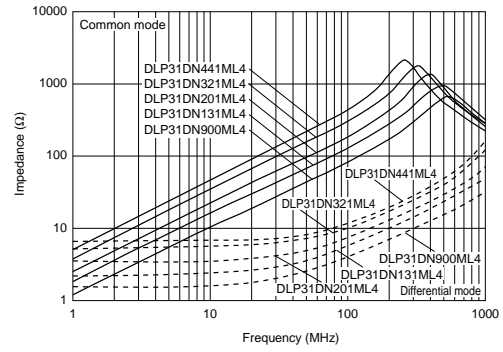

On-Board Type (DC) EMI Suppression Filters (EMIFIL®)



Chip Common Mode Choke Coils Monolithic Type DLM11G/2HG Series

DLM11G Series

Small size chip common mode choke coil.
 Suitable for noise suppression at audio line for mobile phone.

■ Features

1. Small size: 1.25x1.0x0.5mm
2. Noise suppression for personal mobile equipment
3. Enables suppression of both differential mode and common mode noise.
 Common mode impedance:
 600 ohm at 100MHz (typ.)
 Differential mode impedance:
 1200 ohm at 100MHz (typ.)
4. Available for high density mounting (Narrow pitch)

■ Applications

1. Audio line for mobile phones
 (Microphones, Speakers, Headphones)
2. Handsets
3. Personal mobile equipment
 (PDAs, Digital still cameras, MD players)

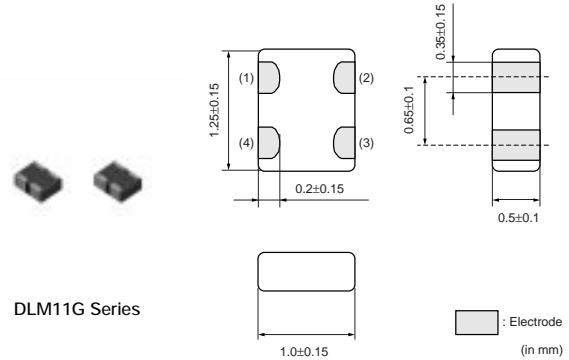

3

| Part Number | Common Mode Impedance (at 100MHz/20 degree C) (ohm) | Rated Current (mA) | Rated Voltage (Vdc) | Insulation Resistance (min.) (M ohm) | Withstand Voltage (Vdc) | DC Resistance (ohm) |
|----------------------|---|-----------------------|------------------------|--|----------------------------|------------------------|
| DLM11GN601SZ2 | 600 ±25% | 100 | 5 | 100 | 25 | 0.8 max. |

Operating Temperature Range: -40°C to 85°C

■ Equivalent Circuit

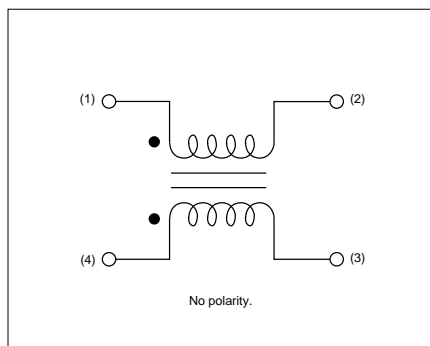

■ Impedance - Frequency

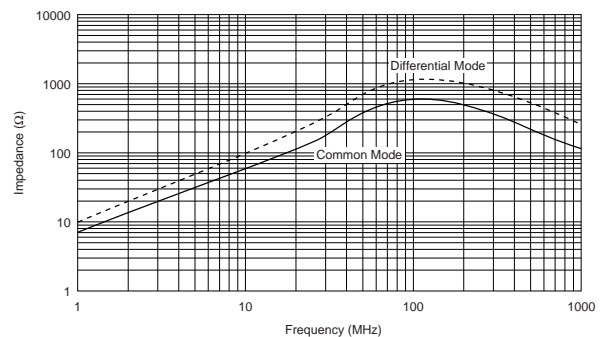

DLM2HG Series

DLM2HG Series is a high quality noise suppression filter for headphone lines of high quality digital music equipment.

■ Features

1. Low distortion in audio signal, low crosstalk
2. Effective in noise suppression both of common mode and of differential mode
3. Small size, low profile, SMD 2.5x2.0x1.2mm

■ Applications

1. Headphone lines of digital music equipment such as DVDs, MD players
2. Headphone lines of Note-PCs, PDAs

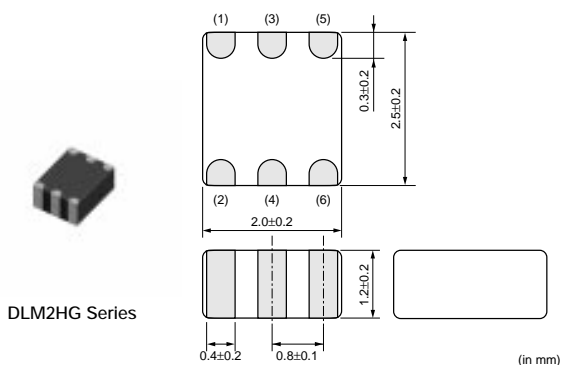

DLM2HG Series

| Part Number | Common Mode Impedance (at 100MHz/20 degree C) (ohm) | Rated Current (mA) | Rated Voltage (Vdc) | Insulation Resistance (min.) (M ohm) | Withstand Voltage (Vdc) | DC Resistance (ohm) |
|----------------------|---|-----------------------|------------------------|--|----------------------------|------------------------|
| DLM2HGN601SZ3 | 600 ±25% | 100 | 16 | 100 | 100 | 0.40 max. |

Operating Temperature Range: -40°C to 85°C

3

■ Equivalent Circuit

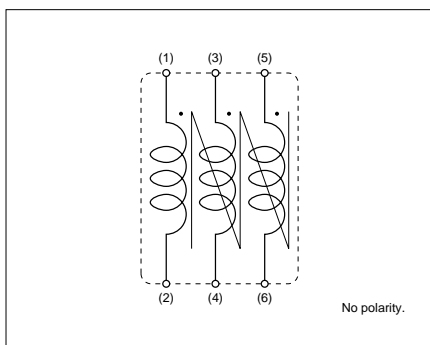

■ Impedance - Frequency

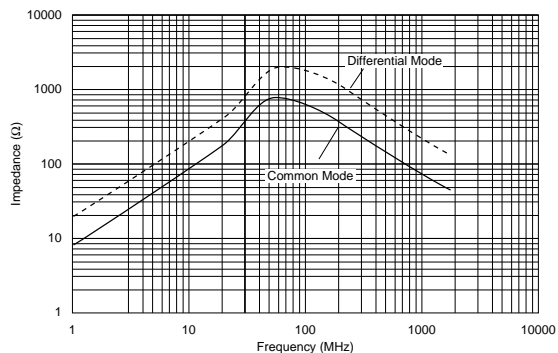

On-Board Type (DC) EMI Suppression Filters (EMIFIL®)



Chip Common Mode Choke Coils Wire Wound Type DLW21S/21H/31S Series

DLW21S Series

■ Features (DLW21S_SQ Series)

- DLW21S series realizes small size and low profile.
2.0x1.2x1.2mm
- High common mode impedance at high frequency effects excellent noise suppression performance.
- Various common mode impedance items of 67 to 370 ohm can be used, considering noise level and signal frequency.
- DLW21S series enables noise suppression for differential signal line without distortion in high speed signal transmission due to its high coupling.
- Small dimension enables higher density packaging.

DLW21S_SQ Series

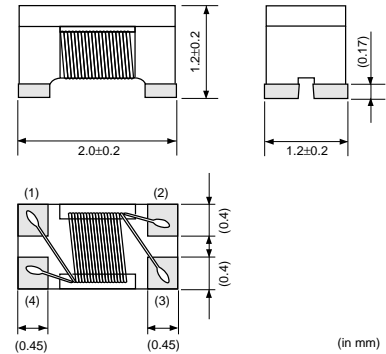

■ Applications

- USB lines of PC, Peripheral equipment
- LVDS lines of Note-PCs, LCDs
- USB lines of Small digital AV equipment such as digital cameras

■ Features (DLW21S_HQ Series)

- Small size: 2.0x1.2x1.2mm
- Common mode impedance items of 67, 90 and 120 ohm, and they can be used for various differential signal lines, DLW21SN_HQ series matches line impedance of 100 ohm line.
- DLW21SN(R)_HQ series can suppress noise for the high-speed differential signal lines which are used in digital AV interfaces, such as HDMI and DVI, without damage to the signal wave.
- In case of using electrostatic protection device with DLW21SR_HQ series match with line impedance of 100 ohm line.

DLW21S_HQ Series

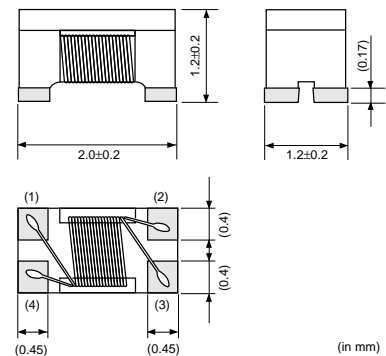

■ Applications

Common mode noise suppression of high speed differential signal lines for HDMI, DVI, USB2.0, IEEE1394, LVDS.

- DVD Recorders
- LCD TVs, LCD monitors
- PCs

DLW21SR_HQ Series is suitable for receiver side of HDMI interface line.

| Part Number | Common Mode Impedance (at 100MHz/20 degree C) (ohm) | Rated Current (mA) | Rated Voltage (Vdc) | Insulation Resistance (min.) (M ohm) | Withstand Voltage (Vdc) | DC Resistance (ohm) |
|---------------|---|--------------------|---------------------|--------------------------------------|-------------------------|---------------------|
| DLW21SN670SQ2 | 67 ±25% | 400 | 50 | 10 | 125 | 0.25 max. |
| DLW21SN900SQ2 | 90 ±25% | 330 | 50 | 10 | 125 | 0.35 max. |
| DLW21SN121SQ2 | 120 ±25% | 370 | 50 | 10 | 125 | 0.30 max. |

Continued on the following page.

Continued from the preceding page.

| Part Number | Common Mode Impedance (at 100MHz/20 degree C) (ohm) | Rated Current (mA) | Rated Voltage (Vdc) | Insulation Resistance (min.) (M ohm) | Withstand Voltage (Vdc) | DC Resistance (ohm) |
|---------------|---|-----------------------|------------------------|--|----------------------------|------------------------|
| DLW21SN181SQ2 | 180 ±25% | 330 | 50 | 10 | 125 | 0.35 max. |
| DLW21SN261SQ2 | 260 ±25% | 300 | 50 | 10 | 125 | 0.40 max. |
| DLW21SN371SQ2 | 370 ±25% | 280 | 50 | 10 | 125 | 0.45 max. |
| DLW21SN670HQ2 | 67 ±25% | 320 | 20 | 10 | 50 | 0.31 max. |
| DLW21SN900HQ2 | 90 ±25% | 280 | 20 | 10 | 50 | 0.41 max. |
| DLW21SN121HQ2 | 120 ±25% | 280 | 20 | 10 | 50 | 0.41 max. |
| DLW21SR670HQ2 | 67 ±25% | 400 | 20 | 10 | 50 | 0.25 max. |

Operating Temperature Range: -40°C to 85°C

Equivalent Circuit

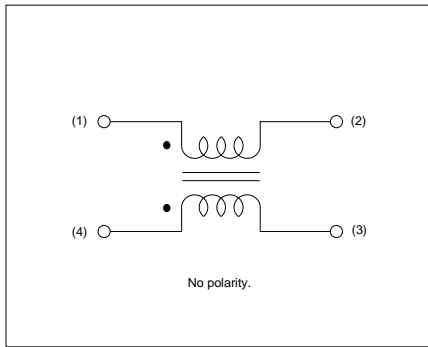

3

Impedance - Frequency

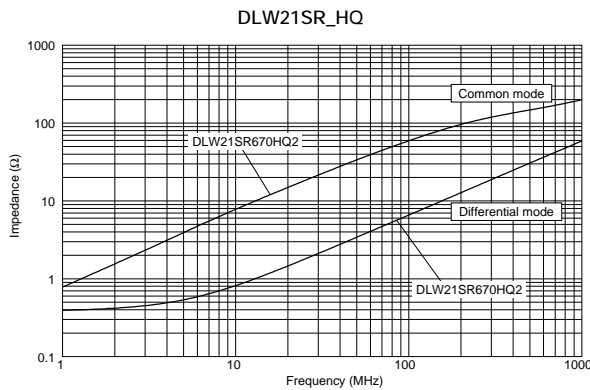
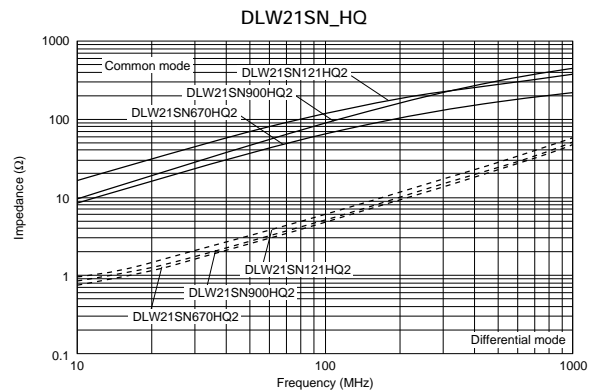
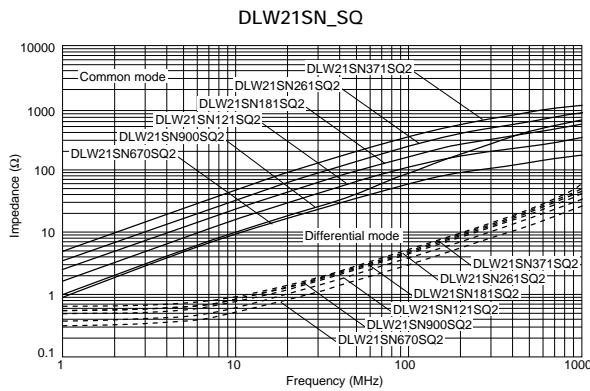

Transmission Characteristics (Typical)

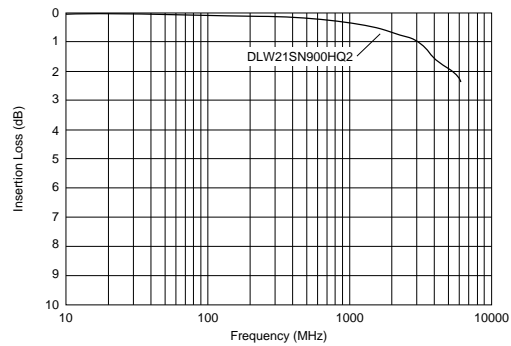

DLW21H Series

■ Features

1. Small size and low profile (2.0x1.2x0.9mm).
Excellent noise suppression for sets of small and thin size.
2. High common mode impedance at high frequency effects excellent noise suppression performance.
3. Various common mode impedance from 67 to 180 ohm can be used, selected depending on noise level and signal frequency.
4. Suitable for differential signal line like USB2.0, IEEE1394 and LVDS, because DLW21H does not provide distortion to high speed signal transmission due to its high coupling. (USB2.0: DLW21HN900SQ2)
5. Small dimension enables higher density mounting

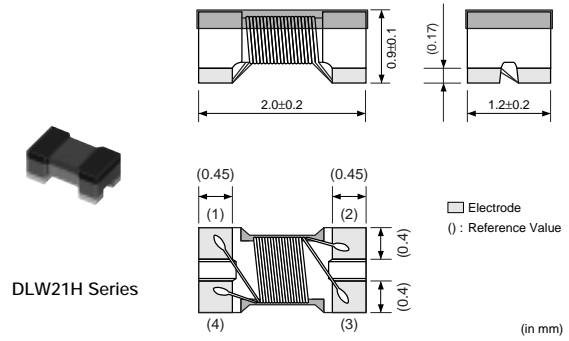

DLW21H Series

■ Applications

Common mode noise suppression of signal lines in high speed and high density digital equipment such as PCs and peripherals and telecommunications equipment.

| Part Number | Common Mode Impedance (at 100MHz/20 degree C) (ohm) | Rated Current (mA) | Rated Voltage (Vdc) | Insulation Resistance (min.) (M ohm) | Withstand Voltage (Vdc) | DC Resistance (ohm) |
|---------------|---|--------------------|---------------------|--------------------------------------|-------------------------|---------------------|
| DLW21HN670SQ2 | 67 ±25% | 330 | 50 | 10 | 125 | 0.35 max. |
| DLW21HN900SQ2 | 90 ±25% | 330 | 50 | 10 | 125 | 0.35 max. |
| DLW21HN121SQ2 | 120 ±25% | 280 | 50 | 10 | 125 | 0.45 max. |
| DLW21HN181SQ2 | 180 ±25% | 250 | 50 | 10 | 125 | 0.50 max. |

Operating Temperature Range: -40°C to 85°C

■ Equivalent Circuit

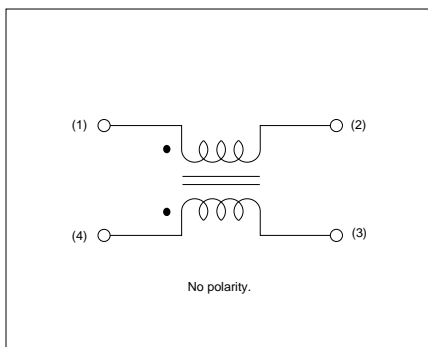

■ Impedance - Frequency

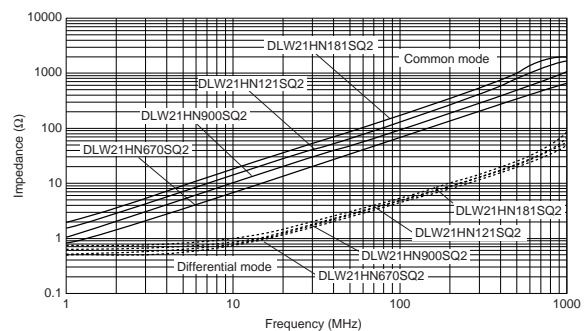

DLW31S Series

■ Features

- DLW31S realizes small size and low profile.
3.2x1.6x1.9mm.
- High common mode impedance at high frequency effects excellent noise suppression performance.
- Various common mode impedance items of 90 to 2200 ohm can be used, considering noise level and signal frequency.
- DLW31S series enables noise suppression for differential signal lines without distortion in high speed signal transmission due to its high coupling.
- Small dimension enables higher density packaging.



DLW31S Series

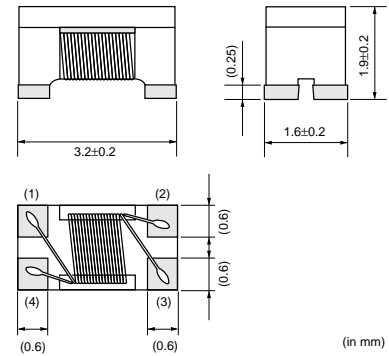

■ Applications

- USB lines of PCs, Peripheral equipment
- LVDS lines of Note-PCs, LCDs

3

| Part Number | Common Mode Impedance (at 100MHz/20 degree C) (ohm) | Rated Current (mA) | Rated Voltage (Vdc) | Insulation Resistance (min.) (M ohm) | Withstand Voltage (Vdc) | DC Resistance (ohm) |
|---------------|---|-----------------------|------------------------|--|----------------------------|------------------------|
| DLW31SN900SQ2 | 90 ±25% | 370 | 50 | 10 | 125 | 0.3 max. |
| DLW31SN161SQ2 | 160 ±25% | 340 | 50 | 10 | 125 | 0.4 max. |
| DLW31SN261SQ2 | 260 ±25% | 310 | 50 | 10 | 125 | 0.5 max. |
| DLW31SN601SQ2 | 600 ±25% | 260 | 50 | 10 | 125 | 0.8 max. |
| DLW31SN102SQ2 | 1000 ±25% | 230 | 50 | 10 | 125 | 1.0 max. |
| DLW31SN222SQ2 | 2200 ±25% | 200 | 50 | 10 | 125 | 1.2 max. |

Operating Temperature Range: -40°C to 85°C

■ Equivalent Circuit

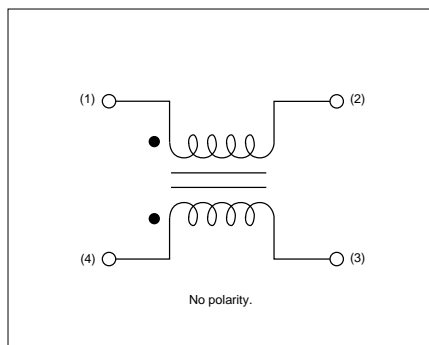

■ Impedance - Frequency

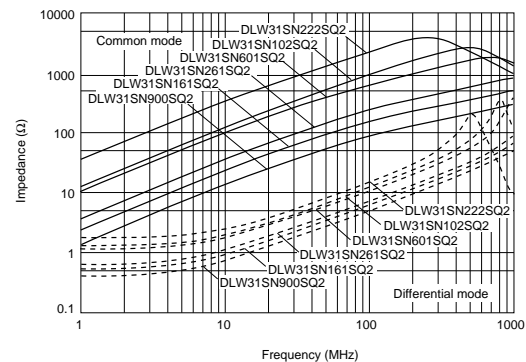

On-Board Type (DC) EMI Suppression Filters (EMIFIL®)



Chip Common Mode Choke Coils Wire Wound Type for Large Current DLW5AH/5BS/5BT Series

DLW5AH/5BS Series

DLW5AH/5BS series is a high performance wound type chip common mode choke coil.

■ Features

1. High impedance (max. of 4000ohm at 100MHz: DLW5AH) enables great noise suppression.
2. Large rated current (max. of 5A) is suitable for power line use.
3. DLW5AH/BS series does not damage high speed signal due to high coupling common mode choke coil structure.
4. Automatic mounting can be applied.

■ Applications

1. DC power lines in AC adapters of Portable equipment
2. DC power lines of DC-DC converters, battery chargers

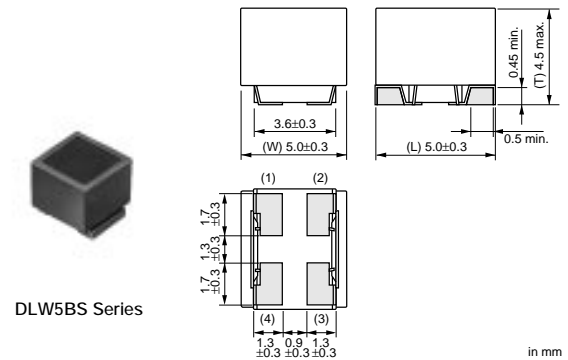
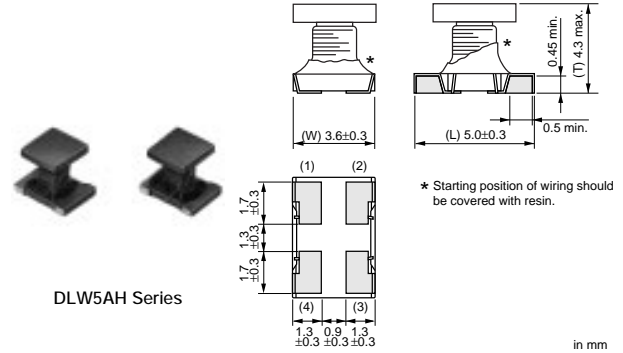

3

| Part Number | Common Mode Impedance (at 100MHz/20 degree C) (ohm) | Rated Current (mA) | Rated Voltage (Vdc) | Insulation Resistance (min.) (M ohm) | Withstand Voltage (Vdc) | DC Resistance (ohm) |
|---------------|---|--------------------|---------------------|--------------------------------------|-------------------------|---------------------|
| DLW5AHN402SQ2 | 4000 (Typ.) | 200 | 50 | 10 | 125 | 3.0 max. |
| DLW5BSN191SQ2 | 190 (Typ.) | 5000 | 50 | 10 | 125 | 0.02 max. |
| DLW5BSN351SQ2 | 350 (Typ.) | 2000 | 50 | 10 | 125 | 0.04 max. |
| DLW5BSN102SQ2 | 1000 (Typ.) | 1500 | 50 | 10 | 125 | 0.06 max. |
| DLW5BSN152SQ2 | 1500 (Typ.) | 1000 | 50 | 10 | 125 | 0.1 max. |
| DLW5BSN302SQ2 | 3000 (Typ.) | 500 | 50 | 10 | 125 | 0.3 max. |

Operating Temperature Range: -25°C to 85°C

In operating temperature exceeding +75°C, derating of current is necessary for DLW5BSN191SQ2.

Please refer to p.138, "Derating of Rated Current".

■ Equivalent Circuit

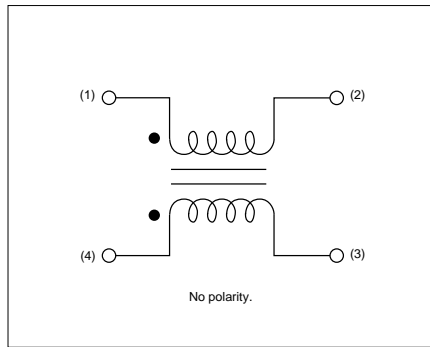

■ Impedance - Frequency

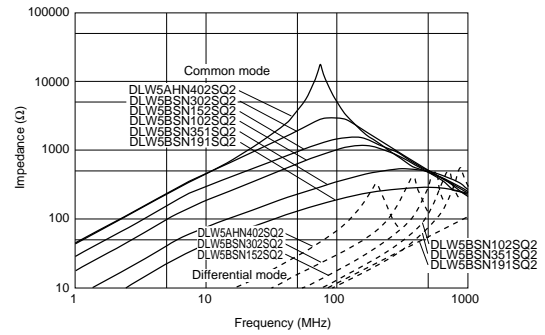

■ Derating of Rated Current

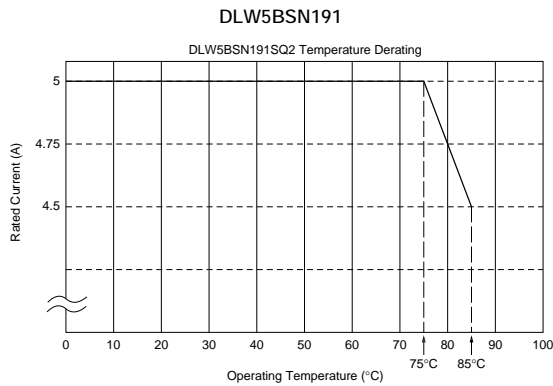

3

DLW5BT Series

Low profile (h=2.5mm) chip common mode choke coil.
 Suitable for noise suppression at DC power lines.

■ Features

1. Low profile (h=2.5mm)
2. Small size (5.0x5.0mm) and high rated current (1.5 to 6A)
3. High common mode Impedance (max. 1400 ohm, at 100MHz)

■ Applications

Noise suppression for power line

1. Power line equipment
 - DC-DC converters
 - Battery chargers
2. Portable equipment
 - PDAs (Personal Digital Assistants)
 - Note PCs
 - Printers

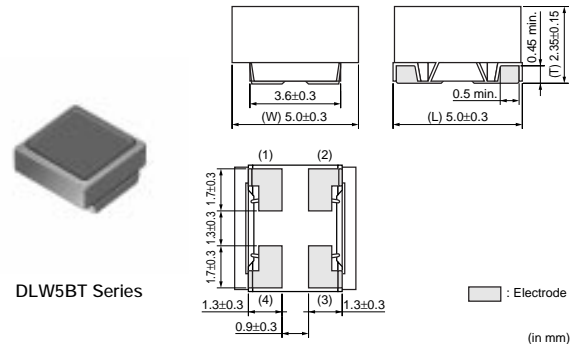

| Part Number | Common Mode Impedance (at 100MHz/20 degree C) (ohm) | Rated Current (mA) | Rated Voltage (Vdc) | Insulation Resistance (min.) (M ohm) | Withstand Voltage (Vdc) | DC Resistance (ohm) |
|---------------|---|--------------------|---------------------|--------------------------------------|-------------------------|---------------------|
| DLW5BTN101SQ2 | 100 (Typ.) | 6000 | 50 | 10 | 125 | 0.009 ±40% |
| DLW5BTN251SQ2 | 250 (Typ.) | 5000 | 50 | 10 | 125 | 0.014 ±40% |
| DLW5BTN501SQ2 | 500 (Typ.) | 4000 | 50 | 10 | 125 | 0.019 ±40% |
| DLW5BTN102SQ2 | 1000 (Typ.) | 2000 | 50 | 10 | 125 | 0.024 ±40% |
| DLW5BTN142SQ2 | 1400 (Typ.) | 1500 | 50 | 10 | 125 | 0.040 ±40% |

Operating Temperature Range: -25°C to 85°C

In operating temperature exceeding +60°C, derating of current is necessary for DLW5BTN101/251/501.

Please refer to p.139, "Derating of Rated Current".

■ Equivalent Circuit

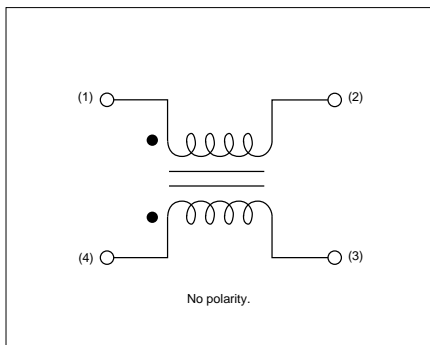

■ Impedance - Frequency

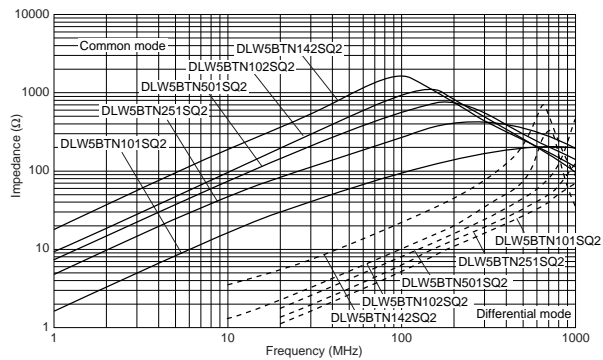

■ Derating of Rated Current

DLW5BTN101/251/501

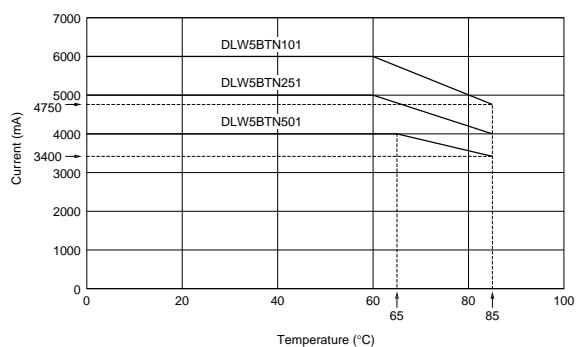

On-Board Type (DC) EMI Suppression Filters (EMIFIL®)



Block Type EMIFIL® BNX Series

SMD Type

BNX022 series is SMD type high performance and provides excellent noise suppression on DC power lines.

■ Features

1. Large rated current (10A-15A) and Low DC Resistance. (0.43m ohm - Typ.)
2. High insertion loss characteristic over a wide frequency range of 1MHz to 1GHz.
3. Mounting area and volume is reduced.
4. Effective for impulse noise such as electro-static discharge or spike noise.

■ Applications

1. Displays (PDP/LCD-TV)
2. Digital AV equipment
3. Amusement equipment
4. PC peripheral equipment
5. Industry equipment, measurement equipment, power supplies



BNX022/023

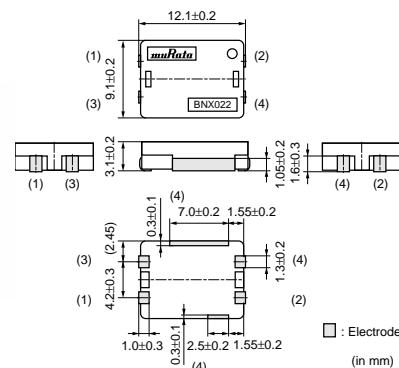

4

| Part Number | Rated Voltage (Vdc) | Withstand Voltage (Vdc) | Rated Current (A) | Insulation Resistance (min.) (M ohm) | Insertion Loss |
|------------------|---------------------|-------------------------|-------------------|--------------------------------------|---|
| BNX022-01 | 50 | 125 | 10 | 500 | 1MHz to 1GHz:35dB min. (20 to 25 degrees C line impedance=50 ohm) |
| BNX023-01 | 100 | 250 | 15 | 500 | 1MHz to 1GHz:35dB min. (20 to 25 degrees C line impedance=50 ohm) |

Operating Temperature Range: -40°C to 125°C
 In operating temperatures exceeding +85°C, derating of current is necessary.
 Please refer to p.141, "Derating of Rated Current".

■ Equivalent Circuit

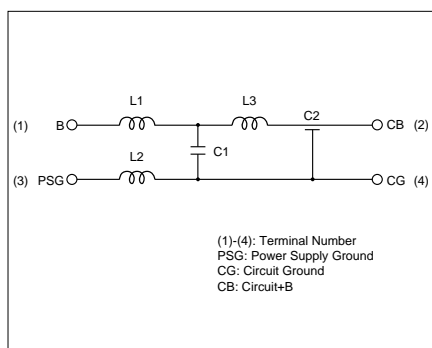

■ Insertion Loss Characteristics

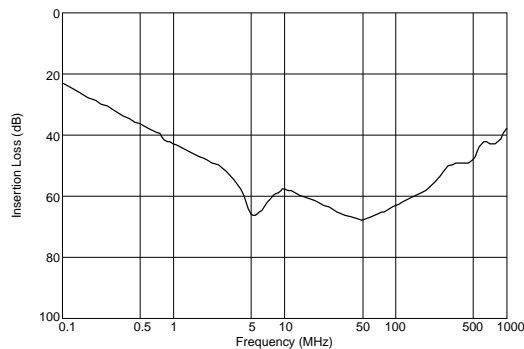

Continued on the following page. ↗

Continued from the preceding page.

Derating of Rated Current

In operating temperatures exceeding +85°C, derating of current is necessary for BNX022 series. Please apply the derating curve shown in chart according to the operating temperature.

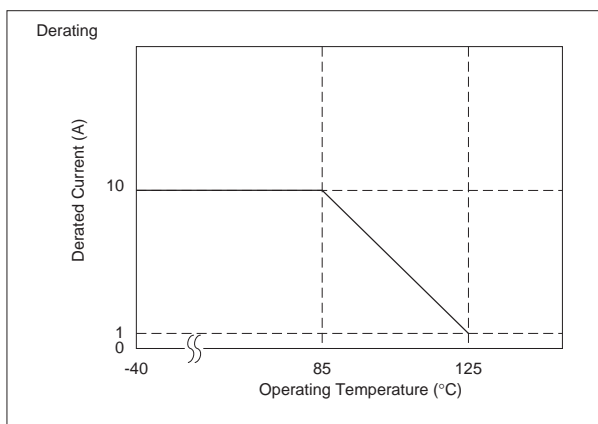

In operating temperatures exceeding +85°C, derating of current is necessary for BNX023 series. Please apply the derating curve shown in chart according to the operating temperature.

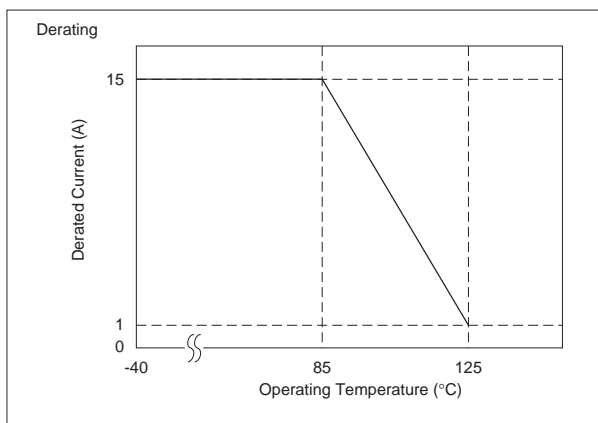

Lead Type

The block type "EMIFIL" BNX series incorporates through-type capacitor, monolithic chip capacitors and bead. The BNX is high performance for use in DC power circuits.

Features

1. The filter enables obtaining high insertion loss in wide frequency ranges from 0.5MHz to 1GHz.
2. Effective for impulse noise such as electrostatic discharge or spike noise.
3. There are no connection routes in the current circuits, thus ensuring highly reliable performance.

Applications

1. Displays (PDP/LCD-TV)
2. Digital AV equipment
3. Amusement equipment
4. PC peripheral equipment
5. Industry equipment

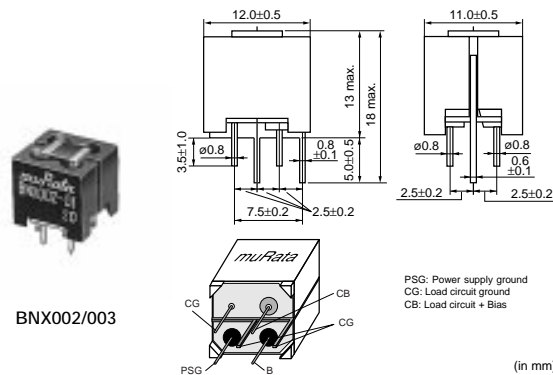

BNX002/003

PSG: Power supply ground
CG: Load circuit ground
CB: Load circuit + Bias

(in mm)

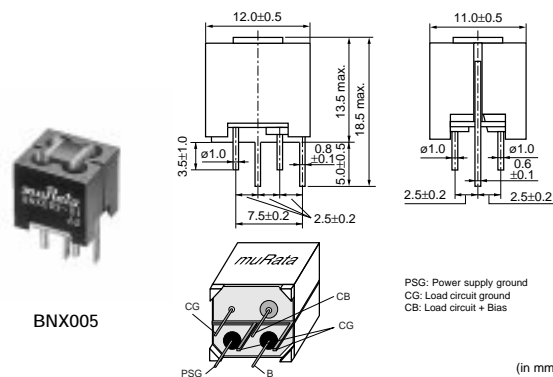

BNX005

PSG: Power supply ground
CG: Load circuit ground
CB: Load circuit + Bias

(in mm)

| Part Number | Rated Voltage (Vdc) | Withstand Voltage (Vdc) | Rated Current (A) | Insulation Resistance (min.) (M ohm) | Insertion Loss |
|------------------|---------------------|-------------------------|-------------------|--------------------------------------|---|
| BNX002-01 | 50 | 125 | 10 | 100 | 1MHz to 1GHz:40dB min. (20 to 25 degrees C line impedance=50 ohm) |
| BNX003-01 | 150 | 375 | 10 | 100 | 5MHz to 1GHz:40dB min. (20 to 25 degrees C line impedance=50 ohm) |
| BNX005-01 | 50 | 125 | 15 | 100 | 1MHz to 1GHz:40dB min. (20 to 25 degrees C line impedance=50 ohm) |

Operating Temperature Range: -30°C to 85°C

Equivalent Circuit

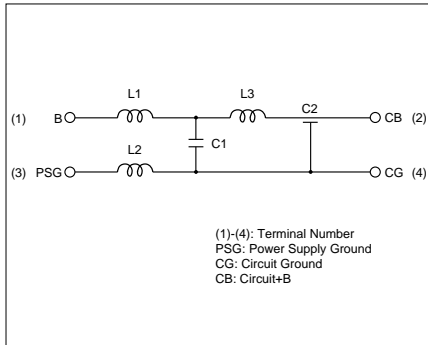

Insertion Loss Characteristics

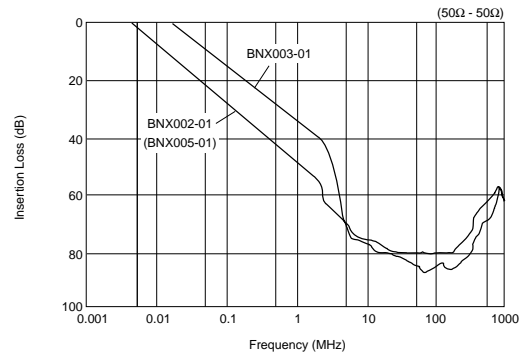

Lead Type Low Profile

The block type "EMIFIL" BNX010 series is high performance and BNX series provide excellent noise suppression on DC power lines.

Features

- High insertion loss characteristic over a wide frequency band range.
 1MHz to 1GHz: 40dB min (BNX012)
 100kHz to 1GHz: 40dB min (BNX016)
- Large rated current (15A) and Low Rdc (0.8m ohm-typ.)
- Low profile (height: 8.0mm except lead terminal)
- Effective for impulse noise such as electrostatic discharge or spike noise.

Applications

- Displays (PDP/LCD-TV)
- Digital AV equipment
- Amusement equipment
- PC peripheral equipment
- Industry equipment

4

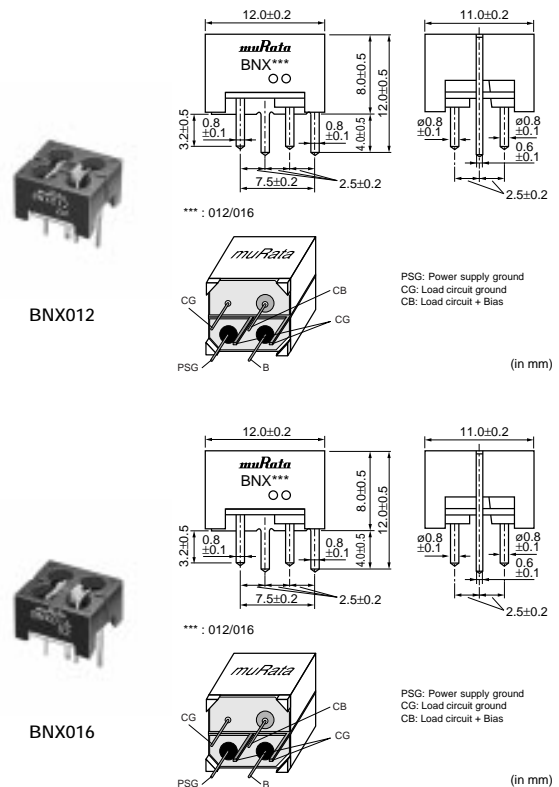

| Part Number | Rated Voltage (Vdc) | Withstand Voltage (Vdc) | Rated Current (A) | Insulation Resistance (min.) (M ohm) | Insertion Loss |
|------------------|---------------------|-------------------------|-------------------|--------------------------------------|---|
| BNX012-01 | 50 | 125 | 15 | 500 | 1MHz to 1GHz:40dB min. (20 to 25 degrees C line impedance=50 ohm) |
| BNX016-01 | 25 | 62.5 | 15 | 50 | 100kHz to 1GHz:40dB min. (20 to 25 degrees C line impedance=50 ohm) |

Operating Temperature Range: -40°C to 125°C

In operating temperatures exceeding +85°C, derating of current is necessary.
 Please refer to p.143, "Derating of Rated Current".

■ Equivalent Circuit

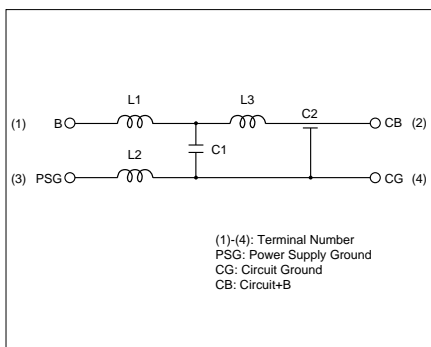

■ Insertion Loss Characteristics

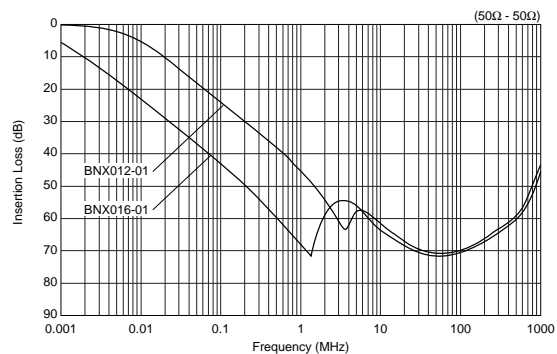

■ Notice

● Rating

In operating temperatures exceeding +85°C, derating of current is necessary for BNX01□ series. Please apply the derating curve shown in chart according to the operating temperature.

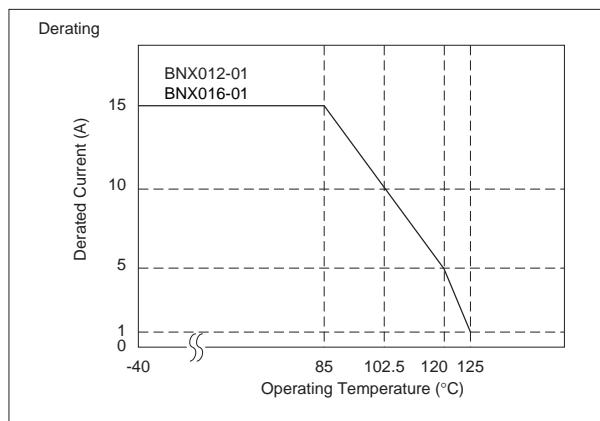

● Connecting ± power line

In case of using ± power line, please connect to each terminal as shown.

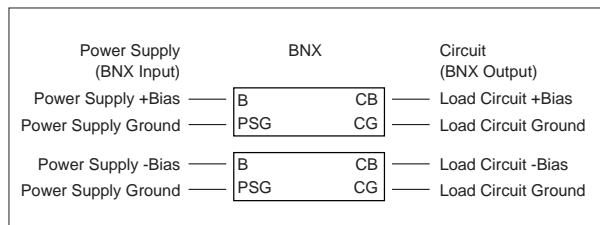

4

Noise Suppression Effect of BNX Series

■ Suppression of DC Side Ripple of the Switching Power Supply

Testing Circuit

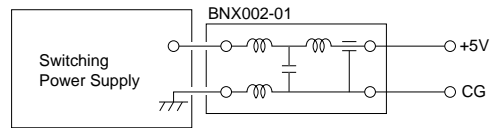

| Type of Filter | EMI Suppression Effect | Description |
|--------------------------------|--|---|
| When BNX002 is not used | <p>+5.0V → 50µs/div 0.2V/div</p> | High frequency noise, max. 0.5V, can be seen. |
| When BNX002 is used | <p>+5.0V → 50µs/div 0.2V/div</p> | Noise can be almost suppressed by BNX002 . |

4

■ Example of Impulse Noise Suppression

| Type of Filter | EMI Suppression Effect |
|-----------------------------|--|
| Without filter | <p>Impulse Noise 2000V/50ns</p> <p>Y-axis: 500V/div X-axis: 10ns/sec</p> |
| When BNX002 is used. | <p>Y-axis: 500V/div X-axis: 10ns/sec</p> |

On-Board Type (DC) EMI Suppression Filters (EMIFIL®)



Ferrite Beads Inductors Part Numbering

Ferrite Beads Inductors

(Part Number)

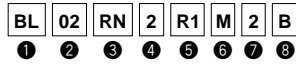

① Product ID

| Product ID | |
|------------|-------------------------|
| BL | Ferrite Beads Inductors |

② Series

| Code | Series |
|------|-----------------------|
| 01 | Beads ϕ 3.6 |
| 02 | Beads ϕ 3.4 |
| 03 | Beads ϕ 2.3 max. |

③ Beads Core Material

| Code | Beads Core Material |
|------|---------------------|
| RN | Standard Type |

④ Numbers of Beads Core

| Code | Numbers of Beads Core |
|------|-----------------------|
| 1 | 1 |
| 2 | 2 |

⑤ Lead Type

| Code | Lead Type | Series |
|------|--|-----------|
| A1 | Axial Straight Type | BL01 |
| A2 | Axial Crimp Type | BL01 |
| R1 | Radial Straight Type | BL02/BL03 |
| R2 | Radial Straight and Wave Formed Leads Type | BL02 |
| R3 | Radial Incrimp Type | BL02 |

⑥ Lead Length, Space

| Code | Lead Length, Space | Series |
|------|-----------------------------|-----------|
| A | Bulk, Axial Type, 3.7mm | BL01 |
| D | Bulk, Axial Type, 45.0mm | |
| E | Taping Axial Type, 26.0mm | |
| F | Taping, Axial Type, 52.0mm | BL02/BL03 |
| J | Bulk, Radial Type, 5.0mm | |
| M | Bulk, Radial Type, 10.0mm | |
| N | Taping, Radial Type, 16.5mm | |
| P | Taping, Radial Type, 18.5mm | |
| Q | Taping, Radial Type, 20.0mm | |

⑦ Lead Diameter

| Code | Lead Diameter |
|------|---------------|
| 1 | ϕ 0.60mm |
| 2 | ϕ 0.65mm |

⑧ Packaging

| Code | Packaging | Series |
|------|----------------------------|----------------|
| A | Ammo Pack | BL01/BL02/BL03 |
| B | Bulk | All Series |
| J | Paper Reel (ϕ 320mm) | BL01 |

On-Board Type (DC) EMI Suppression Filters (EMIFIL®)



Ferrite Beads Inductors BL01/02/03 Series

BL01/BL02/BL03 Series

■ Features

BL01/02/03 series are ferrite beads with lead wires to produce a high frequency loss for suppression of noise. Simple construction and easy-to-use, effective for low impedance circuits such as power supplies and grounds. Effective also for preventing overshoot and undershoot of digital signal in clocks or the like, and suppressing the higher harmonic wave. Suitable for prevention of abnormal oscillation at high frequency amplifying circuit.

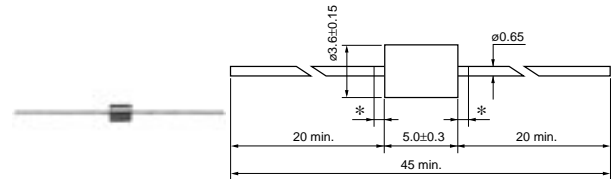

*Coating extending on leads : 1.5 max.

BL01RN1A1D2B

(in mm)

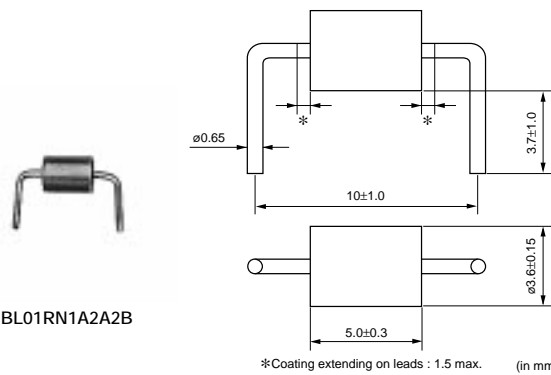

*Coating extending on leads : 1.5 max. (in mm)

BL01RN1A2A2B

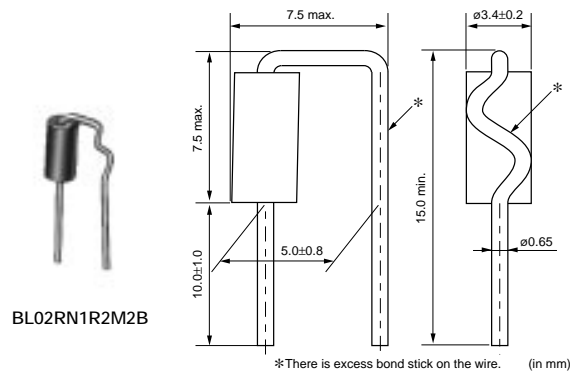

*There is excess bond stick on the wire. (in mm)

BL02RN1R2M2B

(in mm)

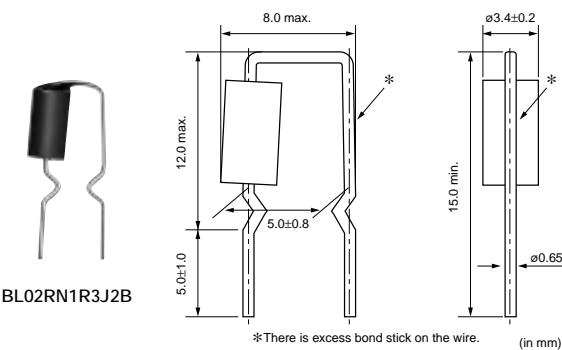

*There is excess bond stick on the wire. (in mm)

BL02RN1R3J2B

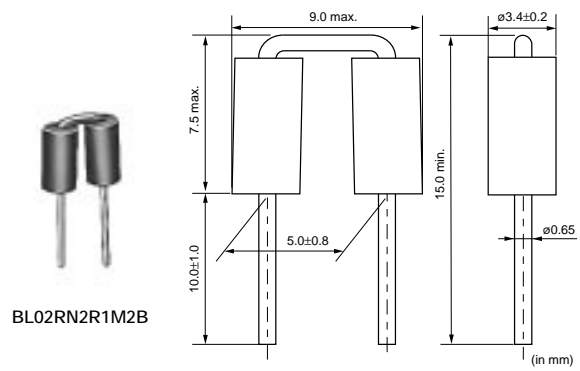

BL02RN2R1M2B

(in mm)

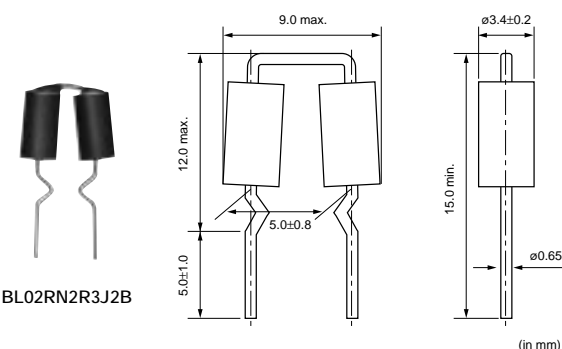

(in mm)

BL02RN2R3J2B

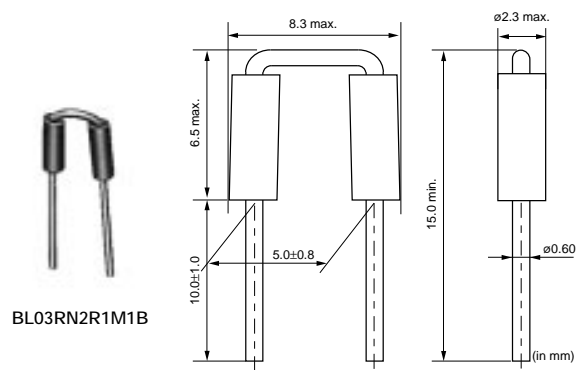

BL03RN2R1M1B

(in mm)

| Part Number | Rated Current (A) | Operating Temperature Range (°C) |
|--------------|-------------------|----------------------------------|
| BL01RN1A1D2B | 7 | -40 to +85 |
| BL01RN1A1E1A | 6 | -40 to +85 |
| BL01RN1A1F1J | 6 | -40 to +85 |
| BL01RN1A2A2B | 7 | -40 to +85 |
| BL02RN1R2M2B | 7 | -40 to +85 |
| BL02RN1R2N1A | 6 | -40 to +85 |
| BL02RN1R2P1A | 6 | -40 to +85 |
| BL02RN1R2Q1A | 6 | -40 to +85 |
| BL02RN1R3J2B | 7 | -40 to +85 |
| BL02RN1R3N1A | 6 | -40 to +85 |
| BL02RN2R1M2B | 7 | -40 to +85 |
| BL02RN2R1N1A | 6 | -40 to +85 |
| BL02RN2R1P1A | 6 | -40 to +85 |
| BL02RN2R1Q1A | 6 | -40 to +85 |
| BL02RN2R3J2B | 7 | -40 to +85 |
| BL02RN2R3N1A | 6 | -40 to +85 |
| BL03RN2R1M1B | 6 | -40 to +85 |
| BL03RN2R1N1A | 6 | -40 to +85 |
| BL03RN2R1P1A | 6 | -40 to +85 |
| BL03RN2R1Q1A | 6 | -40 to +85 |

Please refer to p.193, "Ferrite Beads Inductors Packaging" for Dimensions of Part Numbers except 'B' for the last code.

■ Equivalent Circuit

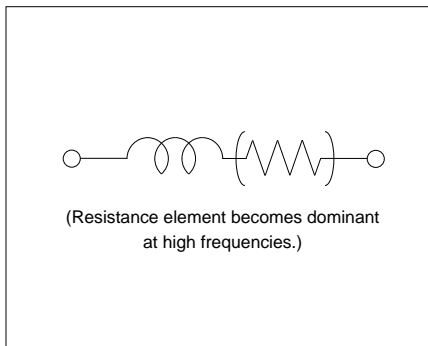

5

■ Impedance - Frequency Characteristics

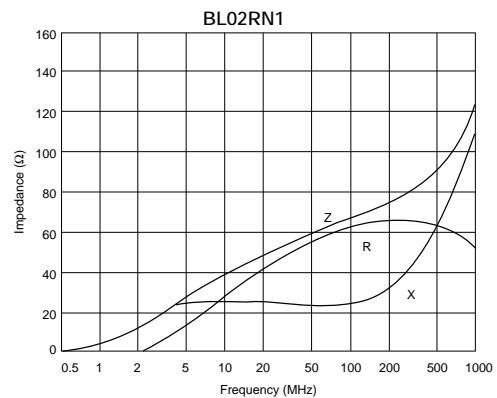
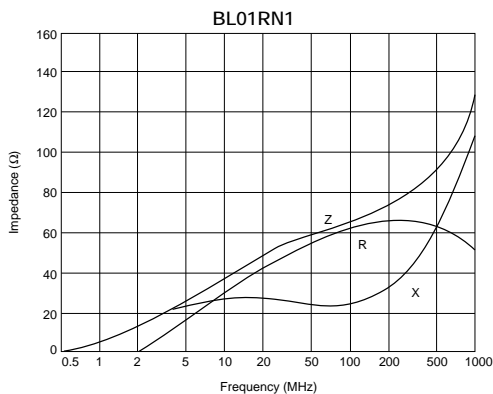

Continued on the following page. ↗

Continued from the preceding page.

■ Impedance - Frequency Characteristics

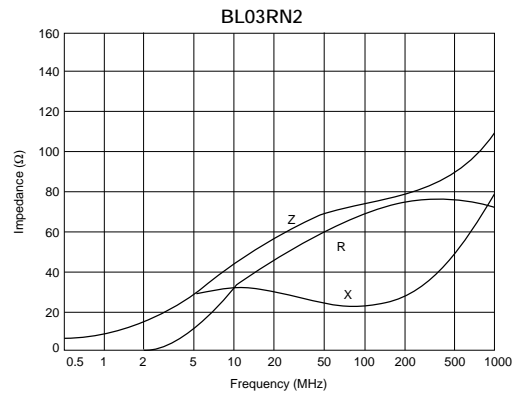
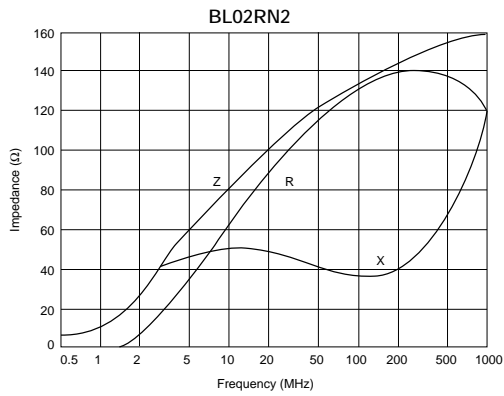

On-Board Type (DC) EMI Suppression Filters (EMIFIL®)



Disc Type EMIFIL® Part Numbering

Disc Type EMIFIL®

(Part Number)

| | | | | | | | | |
|----|---|---|---|----|----|-----|-----|---|
| DS | S | 9 | H | B3 | 2E | 271 | Q55 | B |
| ① | ② | ③ | ④ | ⑤ | ⑥ | ⑦ | ⑧ | ⑨ |

① Product ID

| Product ID | |
|------------|---------------------------|
| DS | Three-terminals Capacitor |

② Structure

| Code | Structure |
|----------|-----------------------------|
| N | No Ferrite Beads Type |
| S | Built-in Ferrite Beads Type |
| T | with Ferrite Beads Type |

③ Style

| Code | Style |
|----------|----------------------|
| 6 | Diameter 8.0mm max. |
| 9 | Diameter 12.0mm max. |

④ Category

| Code | Category |
|----------|-----------------|
| N | for General Use |
| H | for Heavy-duty |

⑤ Temperature Characteristics

| Code | Capacitance Change |
|--------------|--|
| B3/P3 | ±10% (Temperature Range: -25°C to +85°C) |
| C5 | ±22% (Temperature Range: -25°C to +85°C) |
| T3 | +20/-30% (Temperature Range: -25°C to +85°C) |
| E5 | +22/-56% (Temperature Range: -25°C to +85°C) |
| F3 | +30/-80% (Temperature Range: -25°C to +85°C) |
| Z8 | +30/-85% (Temperature Range: -10°C to +60°C) |

⑥ Rated Voltage

| Code | Rated Voltage |
|-----------|---------------|
| 1C | 16V |
| 1H | 50V |
| 2A | 100V |
| 2E | 250V |

⑦ Capacitance

Expressed by three figures. The unit is in pico-farad (pF). The first and second figures are significant digits, and the third figure expresses the number of zeros which follow the two figures.

⑧ Lead Type/⑨ Packaging

| Code | Lead Type | Lead Length* (in mm) | Packaging | Series |
|-------------|-----------|----------------------|---------------------|----------------------------------|
| Q55B | Straight | 25.0 min. | Bulk | All series |
| Q50B | | 4.0±0.5 | | DST9N/H |
| Q52B | | 6.0±1.0 | | DST9N |
| Q54B | | 4.0±0.5 | | DSN6N/9N, DSS6N/9N, DSS9H |
| Q56B | | 6.0±1.0 | | DSS6N |
| T41B | Incrimp | 4.0±0.5 | Paper Reel (ø320mm) | DSS9N/H |
| T51B | | 25.0 min. | | DS□6N, DSN9N/H |
| Q91J | Straight | 20.0±1.0 | Ammo Pack | All series except DSS9N/H |
| Q92J | | 16.5±1.0 | | DSS6N |
| Q93J | | 18.5±1.0 | | |
| Q91A | | 20.0±1.0 | | |
| Q92A | | 16.5±1.0 | | |
| Q93A | 18.5±1.0 | | | |
| U21A | Incrimp | 16.5±1.0 | | |
| U31A | | 18.5±1.0 | | |

*Lead Distance between Reference and Bottom Planes except Bulk.

On-Board Type (DC) EMI Suppression Filters (EMIFIL®)



Disc Type EMIFIL® DSN6/DSS6 Series

■ Features

DS_6 is a compact, high performance lead type EMI suppression filter which can be mounted 2.54mm pitch. Its three terminal structure enables precise high frequency performance.

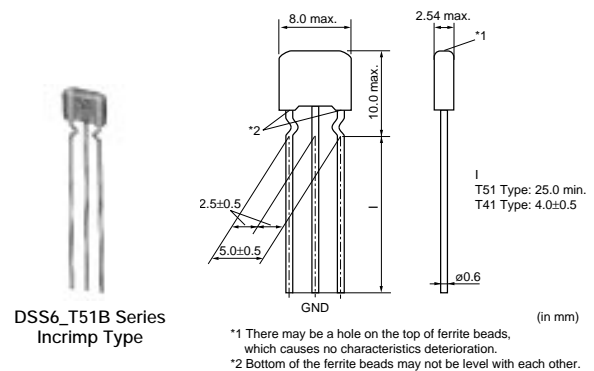
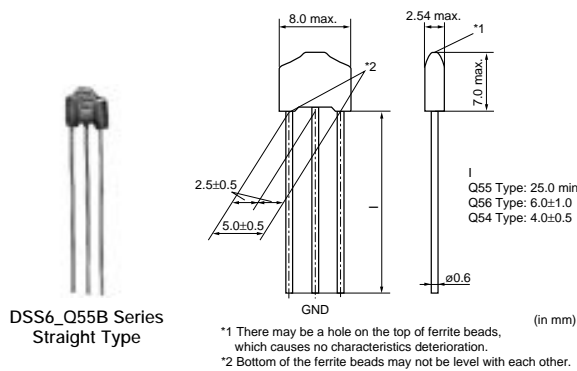
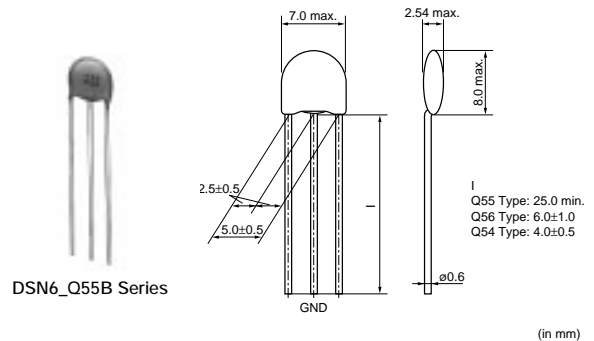

DSN6 Series

| Part Number | Capacitance (pF) | Rated Voltage (Vdc) | Rated Current (A) | Operating Temperature Range (°C) |
|--------------|------------------|---------------------|-------------------|----------------------------------|
| DSN6NC51H220 | 22 +20%, -20% | 50 | 6 | -25 to +85 |
| DSN6NC51H330 | 33 +20%, -20% | 50 | 6 | -25 to +85 |
| DSN6NC51H470 | 47 +20%, -20% | 50 | 6 | -25 to +85 |
| DSN6NC51H101 | 100 +20%, -20% | 50 | 6 | -25 to +85 |
| DSN6NC51H271 | 270 +20%, -20% | 50 | 6 | -25 to +85 |
| DSN6NC51H102 | 1000 +20%, -20% | 50 | 6 | -25 to +85 |
| DSN6NC51H222 | 2200 +20%, -20% | 50 | 6 | -25 to +85 |
| DSN6NZ81H103 | 10000 +80%, -20% | 50 | 6 | -25 to +85 |

Please refer to Part Numbering for Type and Length of Lead.

■ Equivalent Circuit

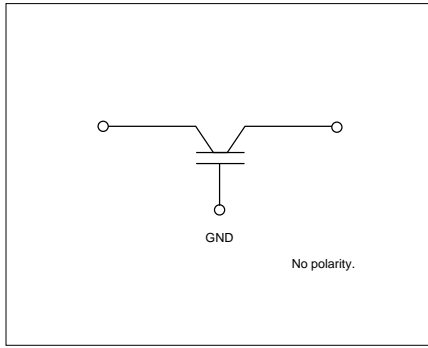

■ Insertion Loss Characteristics

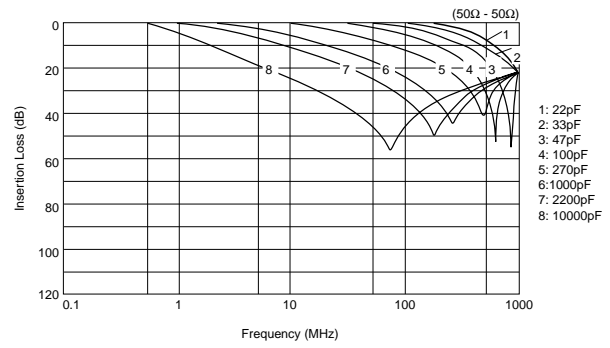

Built-in Ferrite Beads DSS6 Series Straight Type

| Part Number | Capacitance (pF) | Rated Voltage (Vdc) | Rated Current (A) | Operating Temperature Range (°C) |
|--------------|------------------|---------------------|-------------------|----------------------------------|
| DSS6NC52A220 | 22 +20%, -20% | 100 | 6 | -25 to +85 |
| DSS6NC52A330 | 33 +20%, -20% | 100 | 6 | -25 to +85 |
| DSS6NC52A470 | 47 +20%, -20% | 100 | 6 | -25 to +85 |
| DSS6NC52A101 | 100 +20%, -20% | 100 | 6 | -25 to +85 |
| DSS6NC52A151 | 150 +20%, -20% | 100 | 6 | -25 to +85 |
| DSS6NC52A221 | 220 +20%, -20% | 100 | 6 | -25 to +85 |
| DSS6NC52A271 | 270 +20%, -20% | 100 | 6 | -25 to +85 |
| DSS6NC52A471 | 470 +20%, -20% | 100 | 6 | -25 to +85 |
| DSS6NC52A102 | 1000 +20%, -20% | 100 | 6 | -25 to +85 |
| DSS6NE52A222 | 2200 +80%, -20% | 100 | 6 | -25 to +85 |
| DSS6NZ82A103 | 10000 +30%, -30% | 100 | 6 | -25 to +85 |
| DSS6NF31C223 | 22000 +80%, -20% | 16 | 6 | -25 to +85 |

Please refer to Part Numbering for Type and Length of Lead.

■ Equivalent Circuit

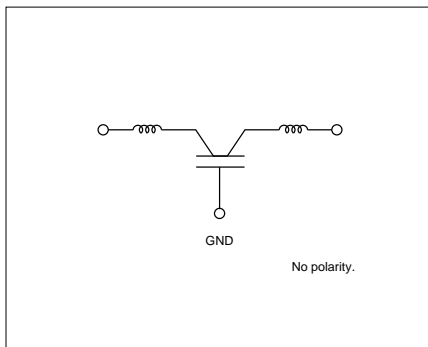

■ Insertion Loss Characteristics

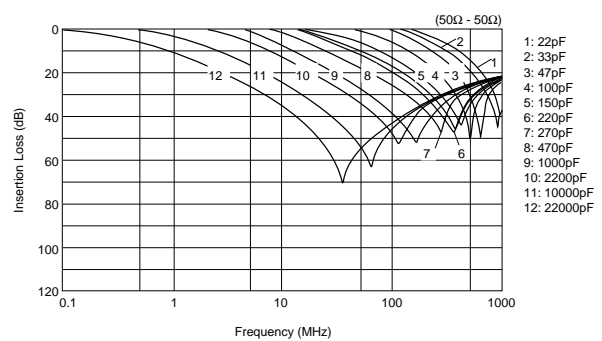

5

Built-in Ferrite Beads DSS6 Series Incrimp Type

| Part Number | Capacitance (pF) | Rated Voltage (Vdc) | Rated Current (A) | Operating Temperature Range (°C) |
|--------------|------------------|---------------------|-------------------|----------------------------------|
| DSS6NC52A220 | 22 +20%, -20% | 100 | 6 | -25 to +85 |
| DSS6NC52A330 | 33 +20%, -20% | 100 | 6 | -25 to +85 |
| DSS6NC52A470 | 47 +20%, -20% | 100 | 6 | -25 to +85 |
| DSS6NC52A101 | 100 +20%, -20% | 100 | 6 | -25 to +85 |
| DSS6NC52A151 | 150 +20%, -20% | 100 | 6 | -25 to +85 |
| DSS6NC52A221 | 220 +20%, -20% | 100 | 6 | -25 to +85 |
| DSS6NC52A271 | 270 +20%, -20% | 100 | 6 | -25 to +85 |
| DSS6NC52A471 | 470 +20%, -20% | 100 | 6 | -25 to +85 |
| DSS6NC52A102 | 1000 +20%, -20% | 100 | 6 | -25 to +85 |
| DSS6NE52A222 | 2200 +80%, -20% | 100 | 6 | -25 to +85 |
| DSS6NZ82A103 | 10000 +30%, -30% | 100 | 6 | -25 to +85 |
| DSS6NF31C223 | 22000 +80%, -20% | 16 | 6 | -25 to +85 |

Please refer to Part Numbering for Type and Length of Lead.

■ Equivalent Circuit

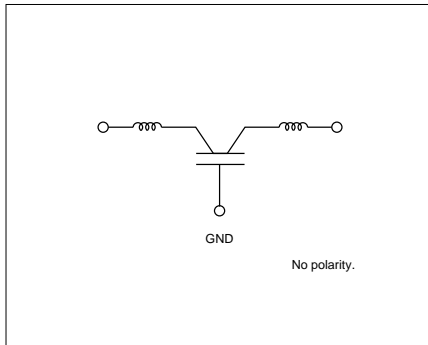

■ Insertion Loss Characteristics

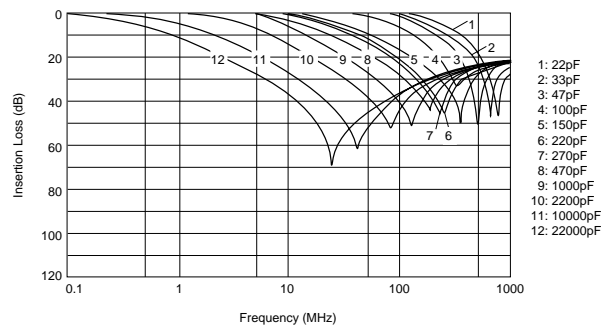

On-Board Type (DC) EMI Suppression Filters (EMIFIL®)



Disc Type EMIFIL® Broad Type DSN9/DSS9/DST9 Series

■ Features

DS_9 is a basic type EMI suppression filter which can obtain high insertion loss in a wide frequency range. Its three terminal structure enables precise high frequency performance. DSS9NP32A222/DSS9NT31H223 are low distortion types for audio circuits.

■ Supplement

Diameter of lead is 0.6mm for taping type.
Taping type is three terminal in-line arrangement.

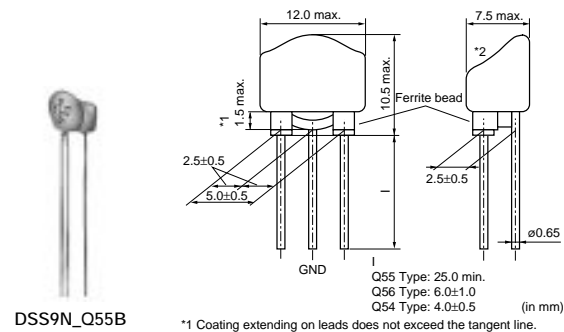
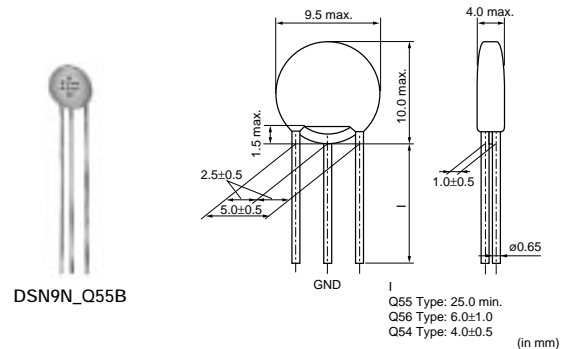

*1 Coating extending on leads does not exceed the tangent line. Exposed electrode, if any, is covered by solder, etc.
 *2 There should not be the exposure of the ferrite bead if a hole is in top of filter, the ferrite bead should not be exposed.

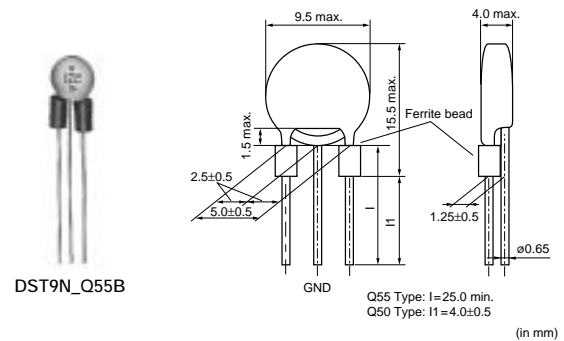

DSN9 Series

| Part Number | Capacitance (pF) | Rated Voltage (Vdc) | Rated Current (A) | Operating Temperature Range (°C) |
|--------------|------------------|---------------------|-------------------|----------------------------------|
| DSN9NC52A271 | 270 +20%,-20% | 100 | 7 | -25 to +85 |
| DSN9NC52A222 | 2200 +20%,-20% | 100 | 7 | -25 to +85 |
| DSN9NC51H223 | 22000 +50%,-20% | 50 | 7 | -25 to +85 |
| DSN9NC51C104 | 100000 +20%,-20% | 16 | 7 | -25 to +85 |

Rated current is 6A for taping type and its lead diameter is phi 0.6mm.
Please refer to Part Numbering for Type and Length of Lead.

Equivalent Circuit

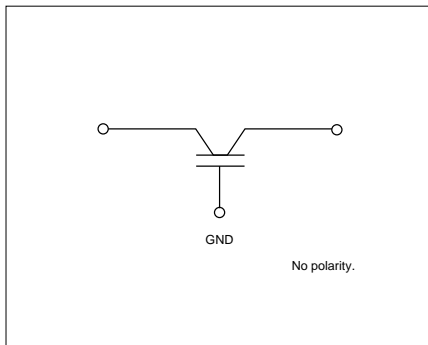

Insertion Loss Characteristics

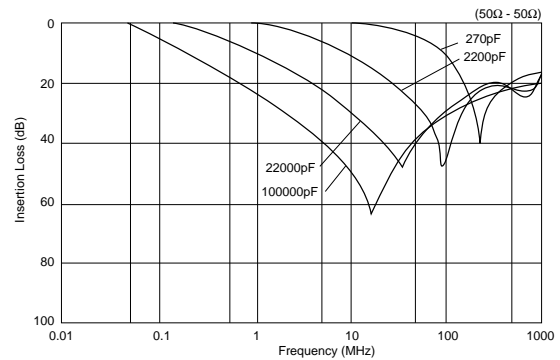

Built-in Ferrite Beads DSS9 Series

| Part Number | Capacitance (pF) | Rated Voltage (Vdc) | Rated Current (A) | Operating Temperature Range (°C) |
|--------------|------------------|---------------------|-------------------|----------------------------------|
| DSS9NC52A220 | 22 +20%,-20% | 100 | 7 | -25 to +85 |
| DSS9NC52A470 | 47 +20%,-20% | 100 | 7 | -25 to +85 |
| DSS9NC52A101 | 100 +20%,-20% | 100 | 7 | -25 to +85 |
| DSS9NC52A271 | 270 +20%,-20% | 100 | 7 | -25 to +85 |
| DSS9NC52A222 | 2200 +20%,-20% | 100 | 7 | -25 to +85 |
| DSS9NP32A222 | 2200 +20%,-20% | 100 | 7 | -25 to +85 |
| DSS9NC51H223 | 22000 +50%,-20% | 50 | 7 | -25 to +85 |
| DSS9NT31H223 | 22000 +50%,-20% | 50 | 7 | -25 to +85 |

Rated current is 6A for taping type and its lead diameter is phi 0.6mm.
DSS9NP32A222/DSS9NT31H223 are low distortion types for audio IF circuits.
Please refer to Part Numbering for Type and Length of Lead.

5

Equivalent Circuit

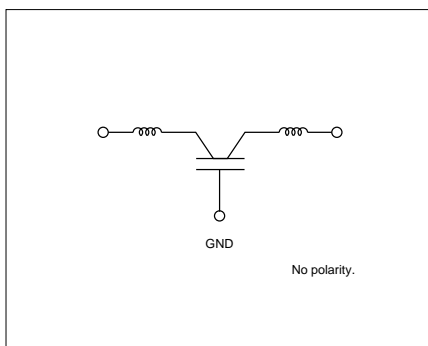

Insertion Loss Characteristics

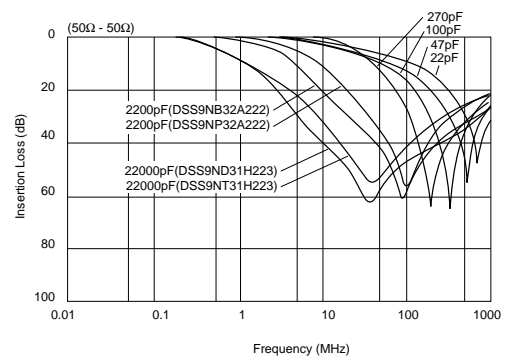

With Ferrite Beads DST9 Series

| Part Number | Capacitance (pF) | Rated Voltage (Vdc) | Rated Current (A) | Operating Temperature Range (°C) |
|---------------------|------------------|---------------------|-------------------|----------------------------------|
| DST9NC52A271 | 270 +20%,-20% | 100 | 7 | -25 to +85 |
| DST9NC52A222 | 2200 +20%,-20% | 100 | 7 | -25 to +85 |
| DST9NC51H223 | 22000 +50%,-20% | 50 | 7 | -25 to +85 |

Rated current is 6A for taping type and its lead diameter is phi 0.6mm.
 Please refer to Part Numbering for Type and Length of Lead.

■ Equivalent Circuit

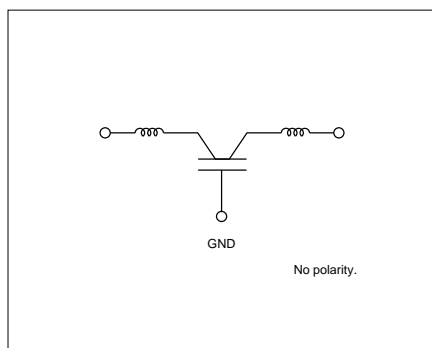

■ Insertion Loss Characteristics

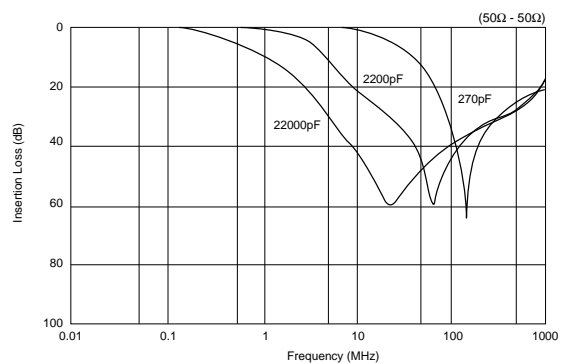

On-Board Type (DC) EMI Suppression Filters (EMIFIL®)



Disc Type EMIFIL® Heavy-duty Type DSN9H/DSS9H/DST9H Series

■ Features

DS_9H is a basic type EMI suppression filter which can obtain high insertion loss in a wide frequency range. Its three terminal structure enables nice high frequency performance. High rated voltage of 250Vdc and wide operating temperature range from -40 degrees C to 105 degrees C are suitable for high reliability circuits.

■ Supplement

Diameter of lead is 0.6mm for taping type.
Taping type is three terminal in-line arrangement.

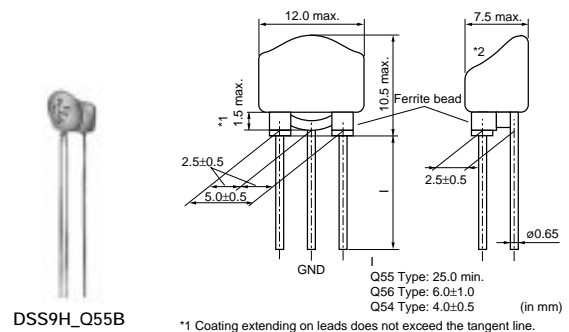
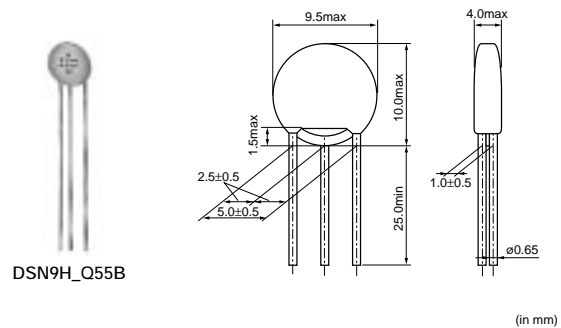

*1 Coating extending on leads does not exceed the tangent line. Exposed electrode, if any, is covered by solder, etc.
 *2 There should not be the exposure of the ferrite bead if a hole is in top of filter, the ferrite bead should not be exposed.

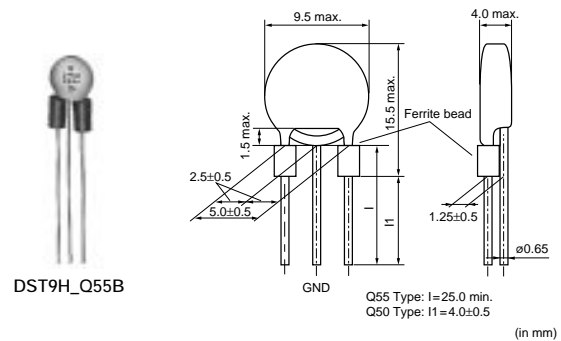

DSN9H Series

| Part Number | Capacitance (pF) | Rated Voltage (Vdc) | Rated Current (A) | Operating Temperature Range (°C) |
|--------------|------------------|---------------------|-------------------|----------------------------------|
| DSN9HB32E220 | 22 +20%, -20% | 250 | 6 | -40 to +105 |
| DSN9HB32E101 | 100 +20%, -20% | 250 | 6 | -40 to +105 |
| DSN9HB32E271 | 270 +20%, -20% | 250 | 6 | -40 to +105 |
| DSN9HB32E222 | 2200 +20%, -20% | 250 | 6 | -40 to +105 |

Please refer to Part Numbering for Type and Length of Lead.

Equivalent Circuit

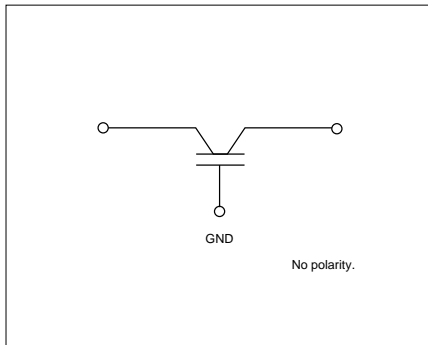

Insertion Loss Characteristics

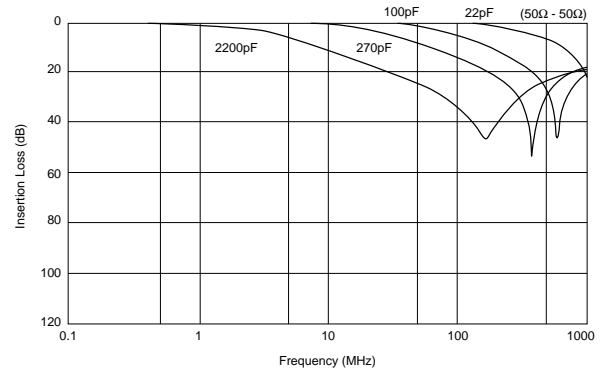

Built-in Ferrite Beads DSS9H Series

| Part Number | Capacitance (pF) | Rated Voltage (Vdc) | Rated Current (A) | Operating Temperature Range (°C) |
|--------------|------------------|---------------------|-------------------|----------------------------------|
| DSS9HB32E220 | 22 +20%, -20% | 250 | 6 | -40 to +105 |
| DSS9HB32E101 | 100 +20%, -20% | 250 | 6 | -40 to +105 |
| DSS9HB32E271 | 270 +20%, -20% | 250 | 6 | -40 to +105 |
| DSS9HB32E222 | 2200 +20%, -20% | 250 | 6 | -40 to +105 |

Please refer to Part Numbering for Type and Length of Lead.

Equivalent Circuit

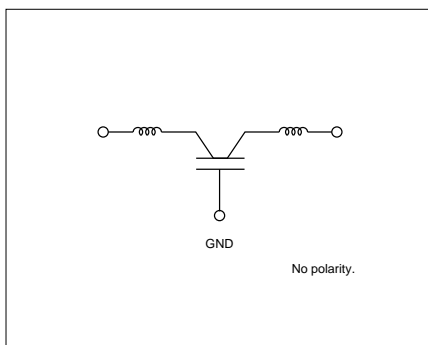

Insertion Loss Characteristics

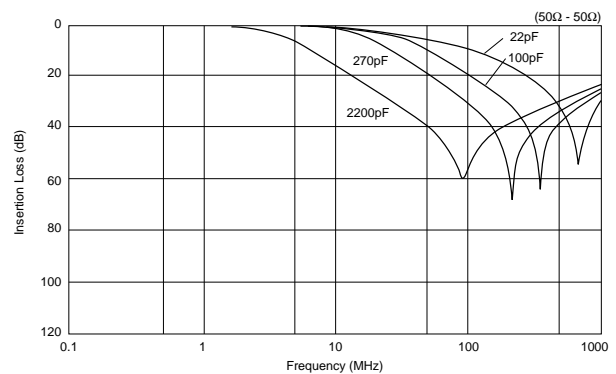

With Ferrite Beads DST9H Series

| Part Number | Capacitance (pF) | Rated Voltage (Vdc) | Rated Current (A) | Operating Temperature Range (°C) |
|--------------|------------------|---------------------|-------------------|----------------------------------|
| DST9HB32E220 | 22 +20%,-20% | 250 | 6 | -40 to +105 |
| DST9HB32E101 | 100 +20%,-20% | 250 | 6 | -40 to +105 |
| DST9HB32E271 | 270 +20%,-20% | 250 | 6 | -40 to +105 |
| DST9HB32E222 | 2200 +20%,-20% | 250 | 6 | -40 to +105 |

Please refer to Part Numbering for Type and Length of Lead.

■ Equivalent Circuit

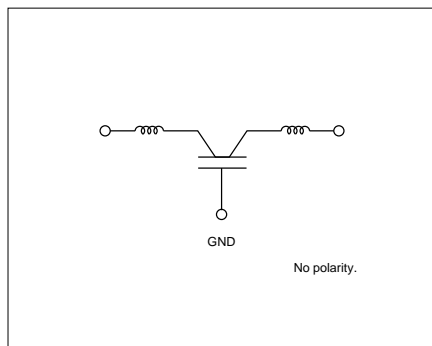

■ Insertion Loss Characteristics

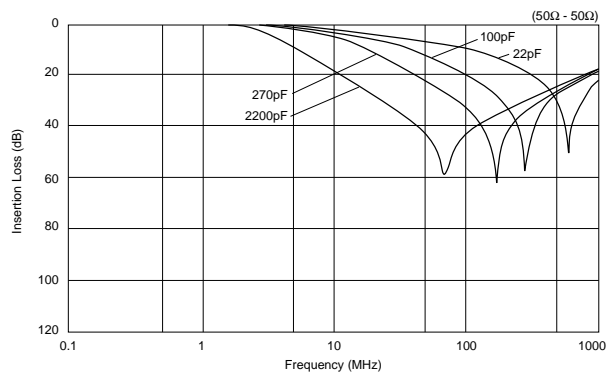

On-Board Type (DC) EMI Suppression Filters (EMIFIL®)



Lead Type EMIGUARD® (EMIFIL® with Varistor Function) Part Numbering

Lead Type EMIGUARD® (EMIFIL® with Varistor Function)

(Part Number)

| | | | | | | | | |
|----|---|---|---|----|----|-----|-----|---|
| VF | S | 6 | V | D8 | 1E | 221 | T51 | B |
| ① | ② | ③ | ④ | ⑤ | ⑥ | ⑦ | ⑧ | ⑨ |

① Product ID

| Product ID | |
|------------|---------------------|
| VF | EMIGUARD® Lead Type |

② Structure

| Code | Structure |
|------|-----------------------------|
| S | Built-in Ferrite Beads Type |
| R | with Resistance |

③ Style

| Code | Style |
|------|-------------------------------|
| 3 | Size is expressed by a figure |
| 6 | |
| 9 | |

④ Features

| Code | Features |
|------|------------------------|
| V | with Varistor Function |

⑤ Temperature Characteristics

| Code | Capacitance Change |
|------|---|
| D8 | +20/-30% (Temperature Range: -40°C to +105°C) |
| D3 | +20/-30% (Temperature Range: -25°C to +85°C) |

⑥ Rated Voltage

| Code | Rated Voltage |
|------|---------------|
| 1E | 25V |
| 1B | 12V |

⑦ Capacitance

Expressed by three figures. The unit is in pico-farad (pF). The first and second figures are significant digits, and the third figure expresses the number of zeros which follow the two figures.

⑧ Lead Type/⑨ Packaging

| Code | Lead Type | Lead Length* | Packaging | Series |
|------|-----------|--------------|---------------------|-----------|
| T51B | Incrimp | 25.0mm min. | Bulk | VFR3/VFS6 |
| U31A | | 18.5+/-1.0mm | Ammo Pack | |
| Q55B | Straight | 25.0mm min. | Bulk | VFS9 |
| Q91J | | 20.0+/-1.0mm | Paper Reel (ø320mm) | |
| Q92J | | 16.5+/-1.0mm | | |
| Q93J | | 18.5+/-1.0mm | | |

*Lead Distance between Reference and Bottom Planes except Bulk.

On-Board Type (DC) EMI Suppression Filters (EMIFIL®)



Lead Type EMIGUARD® (EMIFIL® with Varistor Function) VFR3V/VFS6V/VFS9V Series

for Semiconductor Protection VFR3V Series

■ Features

VFR3V series is designed for ESD surge protection of IC. It efficiently absorbs ESD surges rushed into IC's I/O terminal.

■ Applications

Elimination of noise and protection of semiconductors in office equipment, including computers and peripheral equipment, copy machines, and communication terminals.

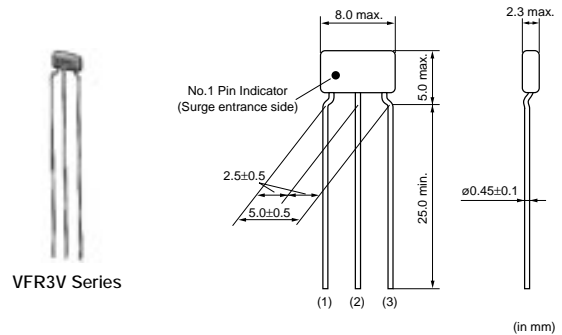

| Part Number | Rated Voltage (Vdc) | Varistor Voltage (Vdc) | Capacitance (pF) | Rated Current (mA) | Peak Pulse Current (A) | Operating Temperature Range (°C) |
|--------------|---------------------|------------------------|------------------|--------------------|------------------------|----------------------------------|
| VFR3VD31E131 | 25 | 50 +20%, -20% | 130 +20%, -20% | 20 | 30 | -25 to 85 |

Please refer to Part Numbering for Type and Length of Lead.

■ Insertion Loss Characteristics

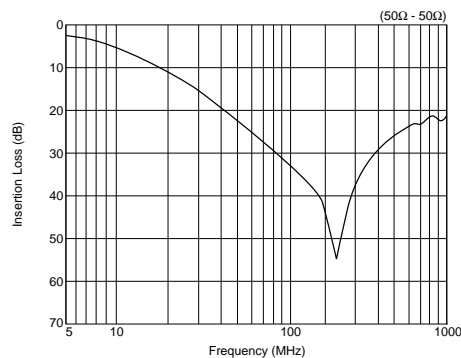

for Signal-Line VFS6V Series

■ Features

VFS6V series is designed for surge protection of signal line. It protects electric circuit from surges such as static electricity and suppresses EMI noise. Built-in ferrite bead gives excellent EMI suppression.

■ Applications

Elimination of noise and protection of electric circuits in office equipment, including computers and peripheral equipment, copy machines, and communication terminals.

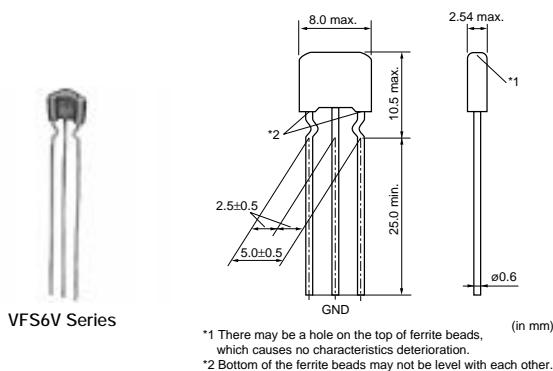

| Part Number | Rated Voltage (Vdc) | Varistor Voltage (Vdc) | Capacitance (pF) | Rated Current (A) | Peak Pulse Current (A) | Operating Temperature Range (°C) |
|--------------|---------------------|------------------------|------------------|-------------------|------------------------|----------------------------------|
| VFS6VD81E221 | 25 | 50 +20%, -20% | 220 +20%, -20% | 6 | 100 | -40 to 105 |

Please refer to Part Numbering for Type and Length of Lead.

■ Equivalent Circuit

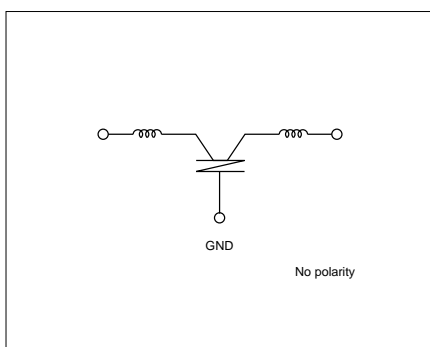

■ Insertion Loss Characteristics

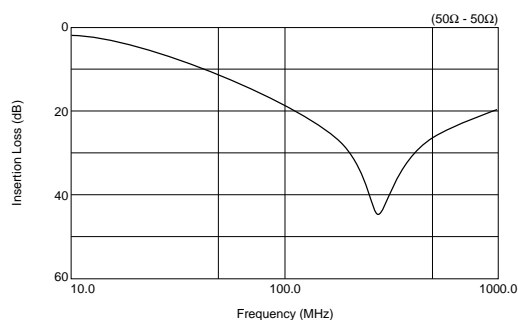

for Large-Current VFS9V Series

■ Features

VFS9V series is designed for surge protection of the power supply. It protects electric circuits from surge such as static electricity and suppresses EMI noise. Its large capacitance value enables high insertion loss for EMI noise.

■ Applications

For circuit protection and noise suppression in electronics equipment such as computers and DC motors, and in electronics systems installed in cars such as car audio equipment and engine controllers.

■ Supplement

Diameter of lead is 0.6mm for taping type.
Taping type is three terminal in-line arrangement.



VFS9V Series

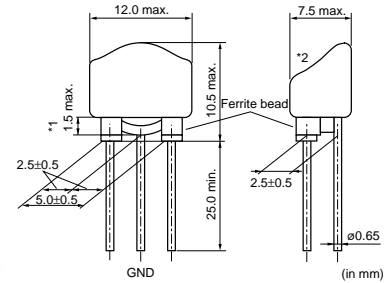

*1 Coating extending on leads does not exceed the tangent line. Exposed electrode, if any, is covered by solder, etc.
 *2 If there is a hole in the top of the filter, the ferrite bead should not be exposed.

| Part Number | Rated Voltage (Vdc) | Varistor Voltage (Vdc) | Capacitance (pF) | Rated Current (A) | Operating Temperature Range (°C) |
|--------------|---------------------|------------------------|------------------|-------------------|----------------------------------|
| VFS9VD31B223 | 12 | 22 +20%,-20% | 22000 +50%,-20% | 7 | -40 to 100 |

Rated current is 7A for bulk type and 6A for taping type.
 Rated current of taping type is 6A because diameter of lead is 0.6mm and its lead layout is in-line type.
 Please refer to Part Numbering for Type and Length of Lead.

■ Equivalent Circuit

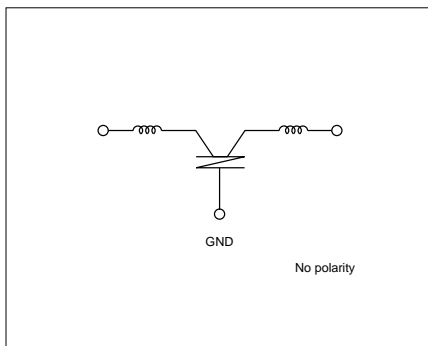

■ Insertion Loss Characteristics

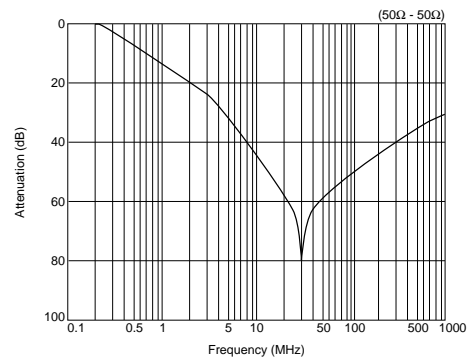

■ Voltage - Current Characteristics

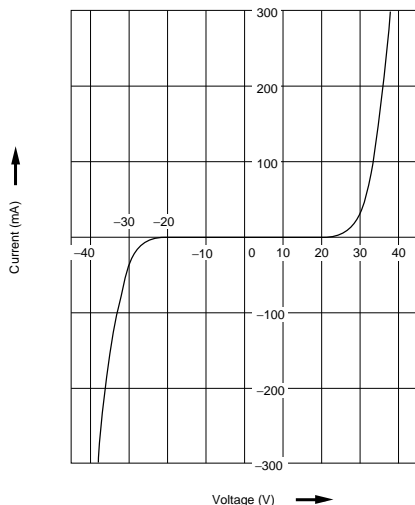

Noise Suppression Effect of VFR/VFS Series

■ Example of IC Protection (VFR3V)

● Testing Method

1. Put ESD surge to IC (7404 family) input terminal with ESD simulator based on IEC 801-2.
2. Check IC's operation.
3. If IC's operation is normal, increase ESD voltage in 1kV steps.
4. Continue above steps 1 to 3 till IC's operation becomes abnormal.

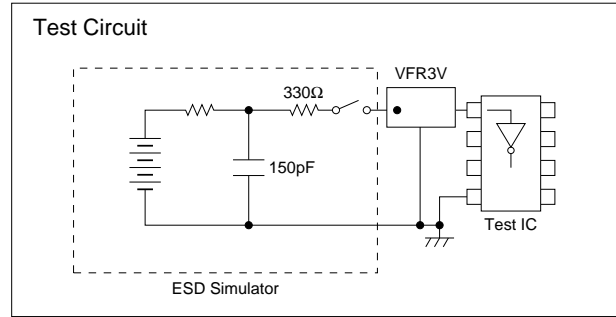

● Result

Varistor VFR3V can protect IC from ESD.

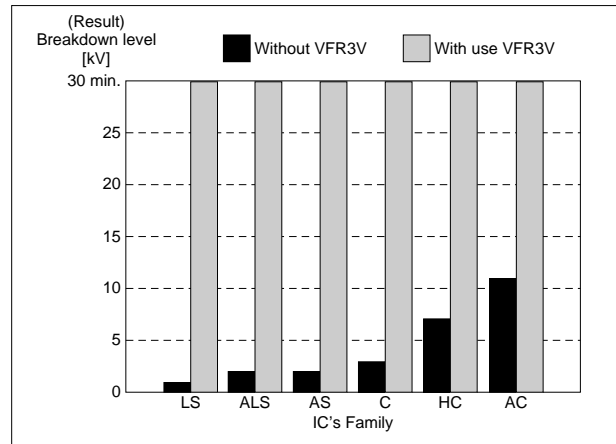

■ Example of EMI Suppression Effect

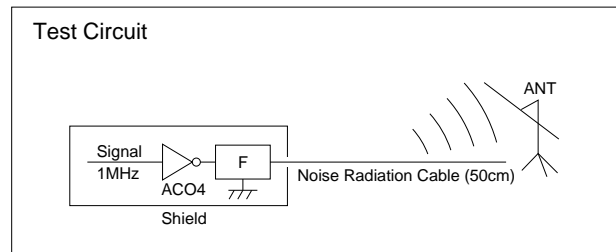

| Type of Filter | EMI Suppression Effect |
|--|------------------------|
| Before Countermeasures (No Filters) | |
| Use VFR3VD31E131T51 | |

Noise Suppression Effect of VFR/VFS Series

■Features (VFS9V)

| Items | Test methods | Rated values | | | | | | | | | | |
|---|---|---|-------|----------------|--------------------------|------------|-----------------------|------------|---|------------|--------------|-----------|
| Overload | 1.4 times the varistor voltage (V_1) is applied for 5 minutes at room temperature. | <table border="1"> <thead> <tr> <th>Items</th> <th>Specifications</th> </tr> </thead> <tbody> <tr> <td>Rated Capacitance Change</td> <td>Within±15%</td> </tr> <tr> <td>Insulation Resistance</td> <td>500kΩ min.</td> </tr> <tr> <td>Rated of Change in Varistor Voltage V_1^*</td> <td>Within±15%</td> </tr> <tr> <td>Voltage Rate</td> <td>1.30 max.</td> </tr> </tbody> </table> <p>*V_1: Voltage when 1mA is applied</p> | Items | Specifications | Rated Capacitance Change | Within±15% | Insulation Resistance | 500kΩ min. | Rated of Change in Varistor Voltage V_1^* | Within±15% | Voltage Rate | 1.30 max. |
| Items | Specifications | | | | | | | | | | | |
| Rated Capacitance Change | Within±15% | | | | | | | | | | | |
| Insulation Resistance | 500kΩ min. | | | | | | | | | | | |
| Rated of Change in Varistor Voltage V_1^* | Within±15% | | | | | | | | | | | |
| Voltage Rate | 1.30 max. | | | | | | | | | | | |
| Surge Test (1) | At room temperature. Surges are applied are 10^5 times every 2 seconds. Then after 1 or 2 hours, the sample is measured. | | | | | | | | | | | |
| Surge Test (2) | At room temperature. Capacitor "C" is charged with 70V, then discharged to apply the voltage to the sample. Tested once (resuming JASO A-1). | | | | | | | | | | | |
| High Temperature Load | At a temperature of $85\pm 3^\circ\text{C}$, the varistor voltage V_1 is continuously applied to the sample for 1000 to 1024 hours. Then it is left at room temperature, for 4 to 24 hours before measuring. | | | | | | | | | | | |

■Pulse-Voltage Breakdown Characteristic (VFS9V)
 VFS9V EMIGUARD® use a self healing varistor- capacitor, so that it can be used under a 500 to 600V surge which would break conventional disk type EMI filters. As shown in figure below EMIGUARD® withstands 2000V impulses applied 1000 times.

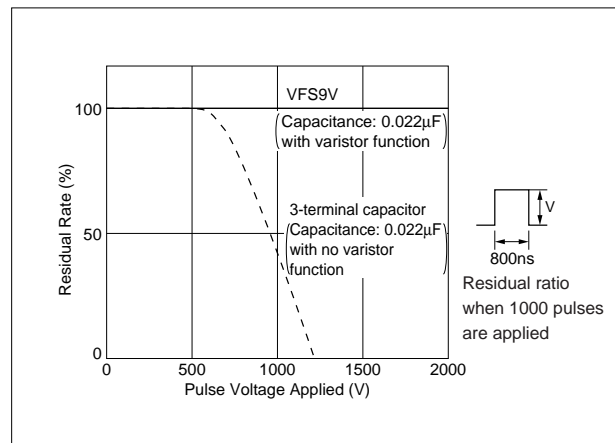
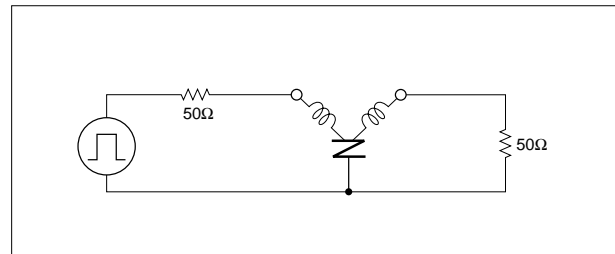

5

■Temperature Characteristics of Varistor Voltage - Insulation Resistance (VFS9V)

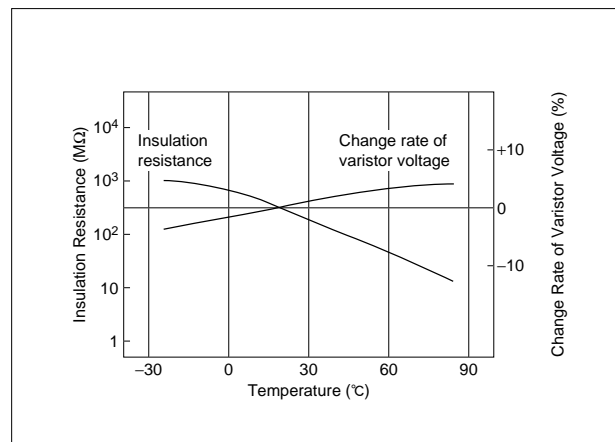

Continued on the following page. ↗

Noise Suppression Effect of VFR/VFS Series

Continued from the preceding page.

■ Noise Absorption Effect of EMIGUARD® (VFS9V)

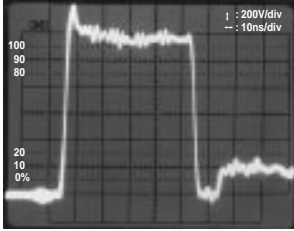
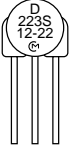
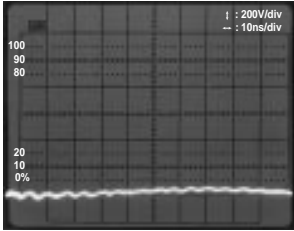
| Type of Filter | EMI Suppression Effect | Description |
|---|---|--|
| without EMIGUARD® |  | Waveform when EMIGUARD® is not used. (Surge from a noise simulator) |
| with EMIGUARD®  |  | Waveform after the noise passed through EMIGUARD®. Little noise is recorded. |

■ Comparative Data (VFS9V)

1. Absorption of quick-rising, high-frequency noise (10ns/div, 100V/div)

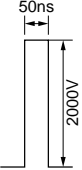
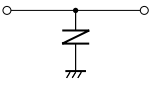
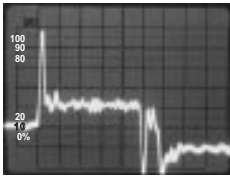
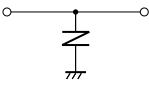
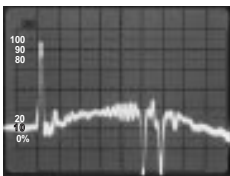
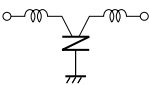
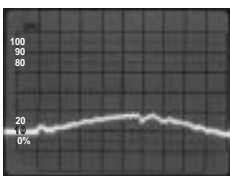
| Type of Filter | EMI Suppression Effect | Description |
|---|---|--|
| without Filters |  Noise wave applied | |
| Conventional varistor  |  | As with the two terminal capacitor |
| Two terminal capacitor (with varistor function)  |  | The two terminal capacitor is influenced by lead line inductance, leaving behind some of the rising and falling edges. The residual noise can cause the system to malfunction. |
| VFS9V  |  | The three terminal structure eliminates most of the lead line inductance. This allows VFS9V to completely absorb the rising and falling edges of the applied pulses. |

Continued on the following page.

Noise Suppression Effect of VFR/VFS Series

☒ Continued from the preceding page.

2. Absorption of wide-pulse noise (50ns/div, 200V/div)

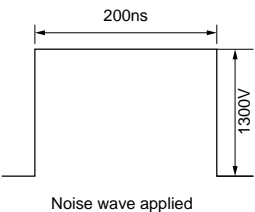
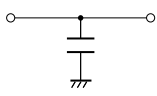
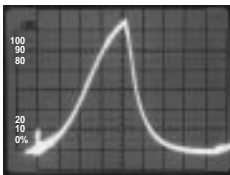
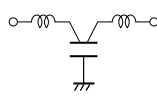
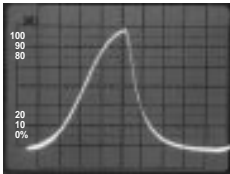
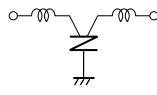
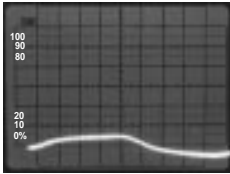
| Type of Filter | EMI Suppression Effect | Description |
|--|---|--|
| without Filters |  <p style="text-align: center;">Noise wave applied</p> | |
| Two terminal capacitor  |  | In capacitors the voltage of the residual surge (1300V) is higher than that of the above example. The wave height is almost the same as the original. |
| Three terminal capacitor (with ferrite bead)  |  | Conventional EMI filters do not work for wide-pulse noise because capacitors are saturated. In this example, the residual 1200V surge can cause the system to breakdown. |
| VFS9V  |  | Bypassing the high voltage to the ground, voltage can be suppressed. |

On-Board Type (DC) EMI Suppression Filters (EMIFIL®)



Common Mode Choke Coils Part Numbering

Common Mode Choke Coils

(Part Number)

| | | | | | | | | |
|----|---|-----|---|-----|-----|---|---|---|
| PL | T | 09H | N | 200 | 3R0 | P | 1 | B |
| ① | ② | ③ | ④ | ⑤ | ⑥ | ⑦ | ⑧ | ⑨ |

① Product ID

| Product ID | |
|------------|-------------------------|
| PL | Common Mode Choke Coils |

② Type

| Code | Type |
|------|---------|
| T | DC Type |

③ Applications

| Code | Applications |
|------|---------------------------------|
| 09H | for DC Line High-frequency Type |

④ Features

| Code | Features |
|------|-------------|
| N | General Use |

⑨ Packaging

| Code | Packaging | Series |
|------|-----------|------------|
| B | Bulk | All series |

⑤ Inductance

Expressed by three figures. The unit is micro-henry (μH). The first and second figures are significant digits, and the third figure expresses the number of zeros which follow the two figures.

⑥ Rated Current

Expressed by three-digit alphanumerics. The unit is in amperes (A). A decimal point is expressed by the capital letter "R". In this case, all figures are significant digits.

⑦ Winding Mode

| Code | Winding Mode |
|------|----------------------|
| P | Aligned Winding Type |

⑧ Lead Dimensions

| Code | Lead Dimensions |
|------|-----------------|
| 1 | 5mm |

On-Board Type (DC) EMI Suppression Filters (EMIFIL®)



Common Mode Choke Coils (for DC Line) PLT09H Series

PLT09H series is a common mode choke coil for DC lines. It is effective against the common mode noise that can cause radiative noise in power supply lines and interface lines. The additional normal mode inductance enables high suppression effect to radiation noise.

■ Features

1. This is a wide frequency range type, applicable in applications ranging from a few MHz to several 100MHz.
2. It features a low-profile design.

■ Applications

1. Noise suppression of SW power supply, DC-DC converter
2. DC power lines in AC adapter of Portable equipment



PLT09H Series

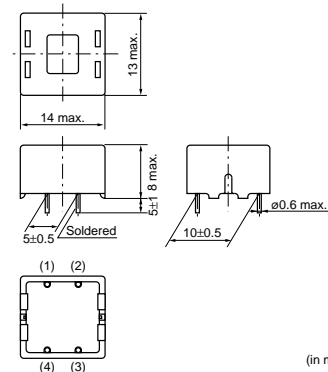

(in mm)

| Part Number | Inductance (min.) (μH) | Rated Current (A) | Rated Voltage (Vdc) | Withstand Voltage (Vdc) |
|-----------------|------------------------|-------------------|---------------------|-------------------------|
| PLT09HN2003R0P1 | 20 min. | 3 | 50 | 125 |

Operating Temperature Range: -40°C to 85°C

■ Equivalent Circuit

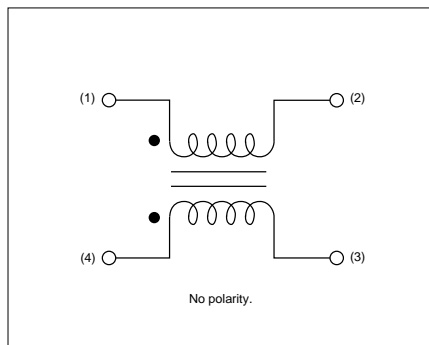

■ Insertion Loss Characteristics

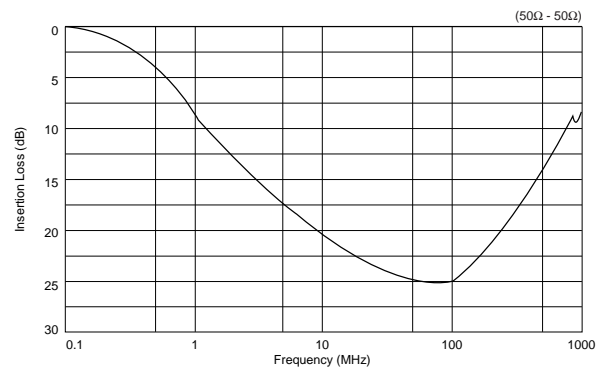

On-Board Type (DC) EMI Suppression Filters (EMIFIL®)



Microwave Absorbers Part Numbering

Microwave Absorber

(Part Number)

| | | | | | | |
|----|------|---|-----|---|-----|-----|
| EA | 1026 | A | 160 | M | 200 | 200 |
| ① | ② | ③ | ④ | ⑤ | ⑥ | ⑦ |

① Product ID

| Product ID | |
|------------|--------------------|
| EA | Microwave Absorber |

② Sheet Type

| Code | Sheet Type |
|------|---|
| 10□□ | Iron carbonyl type (UL certified type/non Halogen type) |
| 2070 | Metal Flake Powder (non Halogen type) |
| 2100 | Metal Flake Powder (UL certified type) |
| 2200 | Metal Flake Powder (UL certified type/non Halogen type) |
| 3008 | Magnetic material (UL certified type/non Halogen type) |

③ Adhesive Tape Type

| Code | Adhesive Tape Type |
|------|--|
| A | Standard tape type (non Halogen type) |
| B | Thin Adhesive tape type (non Halogen type) |
| L | No tape type |
| U | UL certified type (non Halogen type) |

④ Sheet Thickness

Expressed by 3 digits including the second decimal place in mm.

Ex.)

| Code | Sheet Thickness |
|------|-----------------|
| 020 | 0.20mm |

⑤ Unit of Dimension

One capital letter expresses Unit of Dimension (⑤) and Dimensions Length (⑦).

| Code | Unit of Dimension |
|------|-------------------|
| M | in mm (Standard) |
| C | in cm (Standard) |

Standard shape is a rectangle.

Please contact us for other shapes.

⑥ Dimension (Length)

Expressed by 3 digits including the first decimal place.

⑦ Dimension (Width)

Expressed by 3 digits including the first decimal place.

Ex.)

| Code | Dimension (Length × Width) |
|---------|----------------------------|
| M300150 | 30.0×15.0 mm |
| C150100 | 15.0×10.0 cm |

On-Board Type (DC) EMI Suppression Filters (EMIFIL®)



Microwave Absorbers EA10/20/21/22/30 Series

EA10 Series

When inquiring, please contact us with size code, referring to "Part Numbering".

■ Features

1. Excellent elasticity and durability with silicon rubber
2. Suitable for prevention of abnormal oscillation in high frequency modules, suppression of spurious spectra and prevention of interference between circuits
3. Holds easily in equipment with adhesive tape

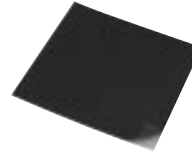

EA10 Series

| Part Number | Applicable Frequency (Typ.) | Thickness (Typ.) (mm) | Flame Resistance | Halogen | Operating Temperature Range |
|-------------|-----------------------------|-----------------------|------------------|--------------|-----------------------------|
| EA1026A100 | 20.0GHz | 1.0 | UL94V-0 | Halogen Free | -40 to +80°C |
| EA1026A160 | 11.5GHz | 1.6 | UL94V-0 | Halogen Free | -40 to +80°C |
| EA1026A180 | 10.0GHz | 1.8 | UL94V-0 | Halogen Free | -40 to +80°C |
| EA1046A180 | 5.8GHz | 1.8 | UL94V-0 | Halogen Free | -40 to +80°C |
| EA1075A270 | 2.5GHz | 2.7 | UL94V-0 | Halogen Free | -40 to +80°C |

■ Reflection Loss

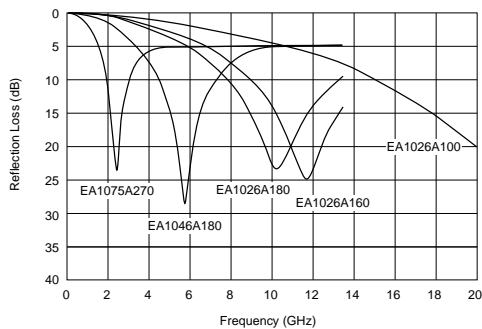

EA20/21/22 Series

When inquiring, please contact us with size code, referring to "Part Numbering".

■ Features

1. Magnetically-shielded high-micro and high-loss characteristics can suppress noise in a wide frequency band for digital equipment.
2. Thin (0.2mm-1.0mm) and flexible sheet makes easy handling in assembly process.
3. Holds easily in equipment with adhesive tape
4. EA20xx series: Non Halogen type
EA21xx series: UL94V-0 certified material is used
EA22xx series: Non Halogen type and UL94V-0 certified material is used



EA20/21/22 Series

| Part Number | Applicable Frequency (Typ.) | Thickness (Typ.) (mm) | Flame Resistance | Halogen | Operating Temperature Range |
|-------------|-----------------------------|-----------------------|------------------|--------------|-----------------------------|
| EA2070A020 | 0.1 to 3.0GHz | 0.20 | - | Halogen Free | -40 to +120°C |
| EA2070A050 | 0.1 to 3.0GHz | 0.50 | - | Halogen Free | -40 to +120°C |
| EA2070A100 | 0.1 to 3.0GHz | 1.00 | - | Halogen Free | -40 to +120°C |
| EA2070B005 | 0.1 to 3.0GHz | 0.05 | - | Halogen Free | -40 to +120°C |
| EA2070B010 | 0.1 to 3.0GHz | 0.10 | - | Halogen Free | -40 to +120°C |
| EA2070B013 | 0.1 to 3.0GHz | 0.13 | - | Halogen Free | -40 to +120°C |
| EA2070B020 | 0.1 to 3.0GHz | 0.20 | - | Halogen Free | -40 to +120°C |
| EA2070B050 | 0.1 to 3.0GHz | 0.50 | - | Halogen Free | -40 to +120°C |
| EA2100A020 | 0.1 to 3.0GHz | 0.20 | UL94V-0 | - | -40 to +120°C |
| EA2100A050 | 0.1 to 3.0GHz | 0.50 | UL94V-0 | - | -40 to +120°C |
| EA2100A100 | 0.1 to 3.0GHz | 1.00 | UL94V-0 | - | -40 to +120°C |
| EA2100B020 | 0.1 to 3.0GHz | 0.20 | UL94V-0 | - | -40 to +120°C |
| EA2100B050 | 0.1 to 3.0GHz | 0.50 | UL94V-0 | - | -40 to +120°C |
| EA2100B100 | 0.1 to 3.0GHz | 1.00 | UL94V-0 | - | -40 to +120°C |
| EA2200A010 | 0.1 to 3.0GHz | 0.1 | UL94V-0 | Halogen Free | -40 to +120°C |
| EA2200A020 | 0.1 to 3.0GHz | 0.2 | UL94V-0 | Halogen Free | -40 to +120°C |
| EA2200A050 | 0.1 to 3.0GHz | 0.5 | UL94V-0 | Halogen Free | -40 to +120°C |
| EA2200A100 | 0.1 to 3.0GHz | 1.0 | UL94V-0 | Halogen Free | -40 to +120°C |
| EA2200B010 | 0.1 to 3.0GHz | 0.1 | UL94V-0 | Halogen Free | -40 to +120°C |
| EA2200B020 | 0.1 to 3.0GHz | 0.2 | UL94V-0 | Halogen Free | -40 to +120°C |
| EA2200B050 | 0.1 to 3.0GHz | 0.5 | UL94V-0 | Halogen Free | -40 to +120°C |
| EA2200B100 | 0.1 to 3.0GHz | 1.0 | UL94V-0 | Halogen Free | -40 to +120°C |

■ Magnetic Permeability - Reluctance (Typical)

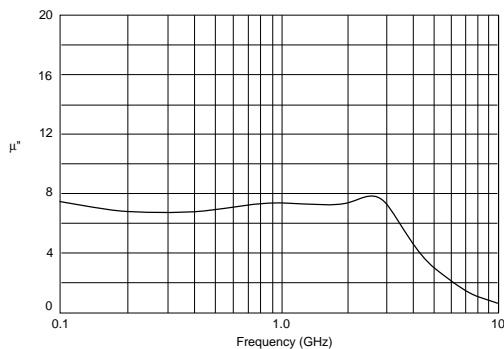

EA30 Series

When inquiring, please contact us with size code, referring to "Part Numbering".

■ Features

1. EMC Absorber magnetically shields and suppresses noise of digital equipment.
2. Flexible sheet, easy handling in assembly process.
3. Holds easily in equipment with adhesive tape.
4. Halogen free and UL94V-0 certified material are used.



EA30 Series

| Part Number | Applicable Frequency (Typ.) | Thickness (Typ.) (mm) | Flame Resistance | Halogen | Operating Temperature Range |
|-------------|-----------------------------|-----------------------|------------------|--------------|-----------------------------|
| EA3008U025 | 0.1 to 3.0GHz | 0.25 | UL94V-0 | Halogen Free | -40 to +120°C |
| EA3008U035 | 0.1 to 3.0GHz | 0.35 | UL94V-0 | Halogen Free | -40 to +120°C |
| EA3008U050 | 0.1 to 3.0GHz | 0.50 | UL94V-0 | Halogen Free | -40 to +120°C |
| EA3008U100 | 0.1 to 3.0GHz | 1.00 | UL94V-0 | Halogen Free | -40 to +120°C |
| EA3008U250 | 0.1 to 3.0GHz | 2.50 | UL94V-0 | Halogen Free | -40 to +120°C |

■ Magnetic Permeability - Reluctance (Typical)

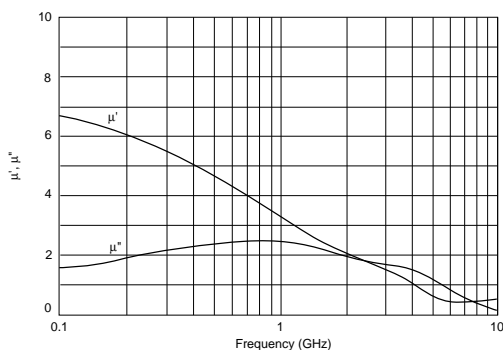

Chip EMIFIL® ⚠ Caution/Notice

■ ⚠ Caution (Rating)

Do not use products beyond the rated current and rated voltage as this may create excessive heat and deteriorate the insulation resistance.

■ ⚠ Caution (Soldering and Mounting)

1. Self-heating

Please provide special attention when mounting chip "EMIFIL" (BLM_P/K/S, NFM_P) series in close proximity to other products that radiate heat.

The heat generated by other products may deteriorate the insulation resistance and cause excessive heat in this component.

2. Mounting Direction

Mount Chip Common Mode Choke Coils in right direction. Wrong direction, which is 90 degrees rotated from right direction, causes not only open or short circuit but also flames or other serious trouble.

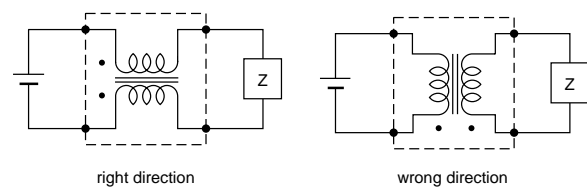

■ Notice (Storage and Operating Conditions)

<Operating Environment>

Do not use products in a chemical atmosphere such as chlorine gas, acid or sulfide gas.

<Storage and Handling requirements>

1. Storage Period

BLM (except BLM15E/15H/15G series) /BLA/NFM55/DLM11G/DLM2HG series should be used within 6 months, the other series should be used within 12 months.

Solderability should be checked if this period is exceeded.

2. Storage Conditions

(1) Storage temperature: -10 to 40 degrees C

Relative humidity: 30 to 70%

Avoid sudden changes in temperature and humidity.

(2) Do not store products in a chemical atmosphere such as chlorine gas, acid or sulfide gas.

■ Notice (Soldering and Mounting)

1. Washing

Failure and degradation of a product are caused by the washing method. When you wash in conditions that are not in mounting information, please contact Murata engineering.

2. Soldering

Reliability decreases with improper soldering methods. Please solder by the standard soldering conditions shown in mounting information.

3. Other

Noise suppression levels resulting from Murata's EMI suppression filters "EMIFIL" may vary, depending on the circuits and ICs used, type of noise, mounting pattern, lead wire length, mounting location, and other operating conditions. Be sure to check and confirm in advance the noise suppression effect of each filter, in actual circuits, etc. before applying the filter in a commercial-purpose equipment design.

Chip EMIFIL® ⚠ Caution/Notice

■ Notice (Handling)

1. Resin coating (Except DLW Series)

Using resin for coating/molding products may affect the products performance.

So please pay careful attention in selecting resin.

Prior to use, please make the reliability evaluation with the product mounted in your application set.

2. Resin coating (DLW Series)

The impedance value may change due to high cure-stress of resin to be used for coating/molding products. An open circuit issue may occur by mechanical stress caused by the resin, amount/cured shape of resin, or operating condition etc. Some resin contains some impurities or chloride possible to generate chlorine by hydrolysis under some operating condition may cause corrosion of wire of coil, leading to open circuit.

So, please pay your careful attention in selecting resin in case of coating/molding the products with the resin. Prior to use the coating resin, please make sure no reliability issue is observed by evaluating products mounted on your board.

3. Caution for use (DLW/NFW Series)

When you hold products with a tweezer, please hold by the sides. Sharp materials, such as a pair of tweezers, should not touch the winding portion to prevent breaking the wire. Mechanical shock should not be applied to the products mounted on the board to prevent breaking the core.

Lead Type EMIFIL® ⚠Caution/Notice

■ ⚠Caution (Rating)

Do not use products beyond the rated current and rated voltage as this may create excessive heat and deteriorate the insulation resistance.

■ ⚠Caution (Soldering and Mounting)

Mounting holes should be designed as specified in these specifications. Other designs than shown in these specifications may cause cracks in ceramics which may lead to smoking or firing.

■ Notice (Storage and Operating Conditions)

<Operating Environment>

1. Do not use products in a chemical atmosphere such as chlorine gas, acid or sulfide gas.
2. Do not use products near water, oil or organic solvents. Avoid environment where dust or dirt may adhere to product.

<Concerning "EMIGUARD">

VFR3V series is designed only to absorb electrostatic surges. Do not use this product to absorb large energy surges such as lighting or switching related surges.

<Storage and Handling Requirements>

1. Storage Period

Used the products within 12 months after delivery.
Solderability should be checked if this period is exceeded.

2. Storage Conditions

- (1) Storage temperature: -10 to 40 degrees C
Relative humidity: 30 to 70%
Avoid sudden changes in temperature and humidity.
- (2) Do not store products in a chemical atmosphere such as chlorine gas, acid or sulfide gas.
- (3) When restoring taping type (BL01RN1A1F1J), please attach the Spacer between flanges of reel. The Spacer is corrugated paper which is attached when shipping.

■ Notice (Soldering and Mounting)

1. Washing

Failure and degradation of a product are caused by the washing method. When you wash in conditions that are not in mounting information, please contact Murata engineering.

2. Soldering

Reliability decreases with improper soldering methods. Please solder by the standard soldering conditions shown in mounting information.

3. Other

Noise suppression levels resulting from Murata's EMI suppression filters "EMIFIL" may vary, depending on the circuits and ICs used, type of noise, mounting pattern, lead wire length, mounting location, and other operating conditions. Be sure to check and confirm in advance the noise suppression effect of each filter, in actual circuits, etc. before applying the filter in a commercial-purpose equipment design.

Microwave Absorbers Notice

■ Notice (Storage and Operating Conditions)

1. Adhesive Tape Stress

This product is designed for using the adhesive tape to hold itself to the object.

And please avoid causing mechanical stress by bending or variation of the object.

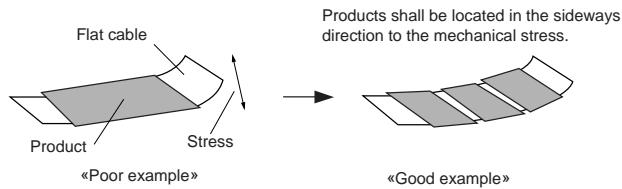

2. Cleaning

Avoid cleaning product.

3. Handling of the product

Adhesive tape must be clean to maintain the quality of tape.

And please wipe off any dirt, dust and any kind of oil from the surface of the object before use.

4. Storage Conditions

(1) Storage period

Products which were inspected in Murata over 6 months ago should be examined and used. This can be confirmed with inspection No. marked on the container. Adhesiveness should be checked if this period is exceeded.

(2) Storage conditions

• Products should be stored in the warehouse on the following conditions.

Temperature: -10 to 40°C

Humidity: 30 to 70% relative humidity

No rapid change on temperature and humidity

• Products should be stored in the warehouse without heat shock, vibration, direct sunlight and so on.

EMIFIL® (Soldering and Mounting)

1. Standard Land Pattern Dimensions

NF□ series suppress noise by conducting the high-frequency noise element to ground. Therefore, to obtain maximum performance from these filters, the ground pattern should be made as large as possible during the PCB design stage. As shown below, one side of the PCB is used for chip mounting, and the other is used for grounding.

Small diameter feedthrough holes are then used to connect the grounds on each side of the PCB. This reduces the high-frequency impedance of the grounding and maximizes the filter's performance.

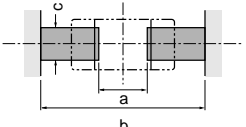
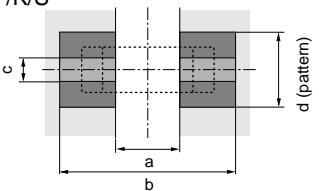

| <p>BLM02 BLM03 BLM15 (Except BLM 15A_AN series)</p> <p>BLM18 BLM21 BLM31 BLM41</p> | <p>●Reflow and Flow BLM Series</p>  <table border="1" style="width: 100%; border-collapse: collapse; margin-top: 10px;"> <thead> <tr> <th>Type</th> <th>Soldering</th> <th>a</th> <th>b</th> <th>c</th> </tr> </thead> <tbody> <tr> <td>BLM02</td> <td>Reflow</td> <td>0.16-0.2</td> <td>0.4-0.56</td> <td>0.2-0.23</td> </tr> <tr> <td>BLM03</td> <td>Reflow</td> <td>0.2-0.3</td> <td>0.6-0.9</td> <td>0.3</td> </tr> <tr> <td>BLM15</td> <td>Reflow</td> <td>0.4</td> <td>1.2-1.4</td> <td>0.5</td> </tr> <tr> <td rowspan="2">BLM18</td> <td>Flow (except 18G)</td> <td rowspan="2">0.7</td> <td>2.2-2.6</td> <td rowspan="2">0.7</td> </tr> <tr> <td>Reflow</td> <td>1.8-2.0</td> </tr> <tr> <td>BLM21</td> <td>Flow/ Reflow</td> <td>1.2</td> <td>3.0-4.0</td> <td>1.0</td> </tr> </tbody> </table> <p>• Except BLM03PG/15PD-PG/18PG-KG-SG/21PG. And BLM02/03/15/18G is specially adapted for reflow soldering.</p> | Type | Soldering | a | b | c | BLM02 | Reflow | 0.16-0.2 | 0.4-0.56 | 0.2-0.23 | BLM03 | Reflow | 0.2-0.3 | 0.6-0.9 | 0.3 | BLM15 | Reflow | 0.4 | 1.2-1.4 | 0.5 | BLM18 | Flow (except 18G) | 0.7 | 2.2-2.6 | 0.7 | Reflow | 1.8-2.0 | BLM21 | Flow/ Reflow | 1.2 | 3.0-4.0 | 1.0 | <p>BLM□□P/K/S</p>  <table border="1" style="width: 100%; border-collapse: collapse; margin-top: 10px;"> <thead> <tr> <th rowspan="2">Type</th> <th rowspan="2">Rated Current (A)</th> <th rowspan="2">Soldering</th> <th rowspan="2">a</th> <th rowspan="2">b</th> <th rowspan="2">c</th> <th colspan="3">Land pad thickness and dimension d</th> </tr> <tr> <th>18μm</th> <th>35μm</th> <th>70μm</th> </tr> </thead> <tbody> <tr> <td rowspan="3">BLM03PG</td> <td>0.75-0.9</td> <td>Reflow</td> <td>0.2-0.3</td> <td>0.6-0.9</td> <td>0.3</td> <td>0.3</td> <td>0.3</td> </tr> <tr> <td>1.3-1.5</td> <td rowspan="2">Reflow</td> <td rowspan="2">0.4</td> <td rowspan="2">1.2-1.4</td> <td rowspan="2">0.5</td> <td>0.5</td> <td>0.5</td> </tr> <tr> <td>1.7-2.2</td> <td>1.2</td> <td>0.7</td> </tr> <tr> <td>BLM15PD</td> <td>1</td> <td>Reflow</td> <td>0.4</td> <td>1.2-1.4</td> <td>0.5</td> <td>0.5</td> <td>0.5</td> </tr> <tr> <td rowspan="4">BLM18PG</td> <td>0.5-1.5</td> <td rowspan="4">Flow/ Reflow</td> <td rowspan="4">0.7</td> <td rowspan="4">2.2-2.6 Reflow 1.8-2.0</td> <td rowspan="4">0.7</td> <td>0.7</td> <td>0.7</td> </tr> <tr> <td>2</td> <td>1.2</td> <td>0.7</td> </tr> <tr> <td>3</td> <td>2.4</td> <td>1.2</td> </tr> <tr> <td>6</td> <td>6.4</td> <td>3.3</td> </tr> <tr> <td rowspan="4">BLM18KG</td> <td>1.3-1.5</td> <td rowspan="4">Flow/ Reflow</td> <td rowspan="4">0.7</td> <td rowspan="4">2.2-2.6 Reflow 1.8-2.0</td> <td rowspan="4">0.7</td> <td>0.7</td> <td>0.7</td> </tr> <tr> <td>1.7-2.2</td> <td>1.2</td> <td>0.7</td> </tr> <tr> <td>3-3.5</td> <td>2.4</td> <td>1.2</td> </tr> <tr> <td>6</td> <td>6.4</td> <td>3.3</td> </tr> <tr> <td rowspan="4">BLM18SG</td> <td>1.5</td> <td rowspan="4">Flow/ Reflow</td> <td rowspan="4">1.2</td> <td rowspan="4">3.0-4.0</td> <td rowspan="4">1.0</td> <td>0.7</td> <td>0.7</td> </tr> <tr> <td>2.5</td> <td>1.2</td> <td>0.7</td> </tr> <tr> <td>3-4</td> <td>2.4</td> <td>1.2</td> </tr> <tr> <td>6</td> <td>6.4</td> <td>3.3</td> </tr> <tr> <td rowspan="4">BLM21PG</td> <td>1.5</td> <td rowspan="4">Flow/ Reflow</td> <td rowspan="4">2.0</td> <td rowspan="4">4.2-5.2</td> <td rowspan="4">1.2</td> <td>1.0</td> <td>1.0</td> </tr> <tr> <td>2</td> <td>1.2</td> <td>1.0</td> </tr> <tr> <td>3</td> <td>2.4</td> <td>1.2</td> </tr> <tr> <td>6</td> <td>6.4</td> <td>3.3</td> </tr> <tr> <td rowspan="3">BLM31PG</td> <td>1.5/2</td> <td rowspan="3">Flow/ Reflow</td> <td rowspan="3">3.0</td> <td rowspan="3">5.5-6.5</td> <td rowspan="3">1.2</td> <td>1.2</td> <td>1.2</td> </tr> <tr> <td>3</td> <td>2.4</td> <td>1.2</td> </tr> <tr> <td>6</td> <td>6.4</td> <td>3.3</td> </tr> <tr> <td rowspan="3">BLM41PG</td> <td>1-2</td> <td rowspan="3">Flow/ Reflow</td> <td rowspan="3">3.0</td> <td rowspan="3">5.5-6.5</td> <td rowspan="3">1.2</td> <td>1.2</td> <td>1.2</td> </tr> <tr> <td>3</td> <td>2.4</td> <td>1.2</td> </tr> <tr> <td>6</td> <td>6.4</td> <td>3.3</td> </tr> </tbody> </table> <p>• Do not apply narrower pattern than listed above to BLM□□P/K/S. Narrow pattern can cause excessive heat or open circuit.</p> | Type | Rated Current (A) | Soldering | a | b | c | Land pad thickness and dimension d | | | 18μm | 35μm | 70μm | BLM03PG | 0.75-0.9 | Reflow | 0.2-0.3 | 0.6-0.9 | 0.3 | 0.3 | 0.3 | 1.3-1.5 | Reflow | 0.4 | 1.2-1.4 | 0.5 | 0.5 | 0.5 | 1.7-2.2 | 1.2 | 0.7 | BLM15PD | 1 | Reflow | 0.4 | 1.2-1.4 | 0.5 | 0.5 | 0.5 | BLM18PG | 0.5-1.5 | Flow/ Reflow | 0.7 | 2.2-2.6 Reflow 1.8-2.0 | 0.7 | 0.7 | 0.7 | 2 | 1.2 | 0.7 | 3 | 2.4 | 1.2 | 6 | 6.4 | 3.3 | BLM18KG | 1.3-1.5 | Flow/ Reflow | 0.7 | 2.2-2.6 Reflow 1.8-2.0 | 0.7 | 0.7 | 0.7 | 1.7-2.2 | 1.2 | 0.7 | 3-3.5 | 2.4 | 1.2 | 6 | 6.4 | 3.3 | BLM18SG | 1.5 | Flow/ Reflow | 1.2 | 3.0-4.0 | 1.0 | 0.7 | 0.7 | 2.5 | 1.2 | 0.7 | 3-4 | 2.4 | 1.2 | 6 | 6.4 | 3.3 | BLM21PG | 1.5 | Flow/ Reflow | 2.0 | 4.2-5.2 | 1.2 | 1.0 | 1.0 | 2 | 1.2 | 1.0 | 3 | 2.4 | 1.2 | 6 | 6.4 | 3.3 | BLM31PG | 1.5/2 | Flow/ Reflow | 3.0 | 5.5-6.5 | 1.2 | 1.2 | 1.2 | 3 | 2.4 | 1.2 | 6 | 6.4 | 3.3 | BLM41PG | 1-2 | Flow/ Reflow | 3.0 | 5.5-6.5 | 1.2 | 1.2 | 1.2 | 3 | 2.4 | 1.2 | 6 | 6.4 | 3.3 |
|---|---|-----------------|-----------|------------------------------|-----|------------------------------------|--------------|--------|----------|----------|----------|--------------|--------|---------|---------|-----|--------------|--------|-----|---------|-----|--------------|----------------------|-----|---------|-----|--------|---------|--------------|-----------------|-----|---------|-----|--|------|-------------------|-----------|---|---|---|------------------------------------|--|--|------|------|------|----------------|----------|--------|---------|---------|-----|-----|-----|---------|--------|-----|---------|-----|-----|-----|---------|-----|-----|----------------|---|--------|-----|---------|-----|-----|-----|----------------|---------|-----------------|-----|------------------------------|-----|-----|-----|---|-----|-----|---|-----|-----|---|-----|-----|----------------|---------|-----------------|-----|------------------------------|-----|-----|-----|---------|-----|-----|-------|-----|-----|---|-----|-----|----------------|-----|-----------------|-----|---------|-----|-----|-----|-----|-----|-----|-----|-----|-----|---|-----|-----|----------------|-----|-----------------|-----|---------|-----|-----|-----|---|-----|-----|---|-----|-----|---|-----|-----|----------------|-------|-----------------|-----|---------|-----|-----|-----|---|-----|-----|---|-----|-----|----------------|-----|-----------------|-----|---------|-----|-----|-----|---|-----|-----|---|-----|-----|
| Type | Soldering | a | b | c | | | | | | | | | | | | | | | | | | | | | | | | | | | | | | | | | | | | | | | | | | | | | | | | | | | | | | | | | | | | | | | | | | | | | | | | | | | | | | | | | | | | | | | | | | | | | | | | | | | | | | | | | | | | | | | | | | | | | | | | | | | | | | | | | | | | | | | | | | | | | | | | | | | | | | | | | | | | | | | | | | | | |
| BLM02 | Reflow | 0.16-0.2 | 0.4-0.56 | 0.2-0.23 | | | | | | | | | | | | | | | | | | | | | | | | | | | | | | | | | | | | | | | | | | | | | | | | | | | | | | | | | | | | | | | | | | | | | | | | | | | | | | | | | | | | | | | | | | | | | | | | | | | | | | | | | | | | | | | | | | | | | | | | | | | | | | | | | | | | | | | | | | | | | | | | | | | | | | | | | | | | | | | | | | | | |
| BLM03 | Reflow | 0.2-0.3 | 0.6-0.9 | 0.3 | | | | | | | | | | | | | | | | | | | | | | | | | | | | | | | | | | | | | | | | | | | | | | | | | | | | | | | | | | | | | | | | | | | | | | | | | | | | | | | | | | | | | | | | | | | | | | | | | | | | | | | | | | | | | | | | | | | | | | | | | | | | | | | | | | | | | | | | | | | | | | | | | | | | | | | | | | | | | | | | | | | | |
| BLM15 | Reflow | 0.4 | 1.2-1.4 | 0.5 | | | | | | | | | | | | | | | | | | | | | | | | | | | | | | | | | | | | | | | | | | | | | | | | | | | | | | | | | | | | | | | | | | | | | | | | | | | | | | | | | | | | | | | | | | | | | | | | | | | | | | | | | | | | | | | | | | | | | | | | | | | | | | | | | | | | | | | | | | | | | | | | | | | | | | | | | | | | | | | | | | | | |
| BLM18 | Flow (except 18G) | 0.7 | 2.2-2.6 | 0.7 | | | | | | | | | | | | | | | | | | | | | | | | | | | | | | | | | | | | | | | | | | | | | | | | | | | | | | | | | | | | | | | | | | | | | | | | | | | | | | | | | | | | | | | | | | | | | | | | | | | | | | | | | | | | | | | | | | | | | | | | | | | | | | | | | | | | | | | | | | | | | | | | | | | | | | | | | | | | | | | | | | | | |
| | Reflow | | 1.8-2.0 | | | | | | | | | | | | | | | | | | | | | | | | | | | | | | | | | | | | | | | | | | | | | | | | | | | | | | | | | | | | | | | | | | | | | | | | | | | | | | | | | | | | | | | | | | | | | | | | | | | | | | | | | | | | | | | | | | | | | | | | | | | | | | | | | | | | | | | | | | | | | | | | | | | | | | | | | | | | | | | | | | | | | |
| BLM21 | Flow/ Reflow | 1.2 | 3.0-4.0 | 1.0 | | | | | | | | | | | | | | | | | | | | | | | | | | | | | | | | | | | | | | | | | | | | | | | | | | | | | | | | | | | | | | | | | | | | | | | | | | | | | | | | | | | | | | | | | | | | | | | | | | | | | | | | | | | | | | | | | | | | | | | | | | | | | | | | | | | | | | | | | | | | | | | | | | | | | | | | | | | | | | | | | | | | |
| Type | Rated Current (A) | Soldering | a | b | c | Land pad thickness and dimension d | | | | | | | | | | | | | | | | | | | | | | | | | | | | | | | | | | | | | | | | | | | | | | | | | | | | | | | | | | | | | | | | | | | | | | | | | | | | | | | | | | | | | | | | | | | | | | | | | | | | | | | | | | | | | | | | | | | | | | | | | | | | | | | | | | | | | | | | | | | | | | | | | | | | | | | | | | | | | | | | | | |
| | | | | | | 18μm | 35μm | 70μm | | | | | | | | | | | | | | | | | | | | | | | | | | | | | | | | | | | | | | | | | | | | | | | | | | | | | | | | | | | | | | | | | | | | | | | | | | | | | | | | | | | | | | | | | | | | | | | | | | | | | | | | | | | | | | | | | | | | | | | | | | | | | | | | | | | | | | | | | | | | | | | | | | | | | | | | | | | | | | | | |
| BLM03PG | 0.75-0.9 | Reflow | 0.2-0.3 | 0.6-0.9 | 0.3 | 0.3 | 0.3 | | | | | | | | | | | | | | | | | | | | | | | | | | | | | | | | | | | | | | | | | | | | | | | | | | | | | | | | | | | | | | | | | | | | | | | | | | | | | | | | | | | | | | | | | | | | | | | | | | | | | | | | | | | | | | | | | | | | | | | | | | | | | | | | | | | | | | | | | | | | | | | | | | | | | | | | | | | | | | | | | |
| | 1.3-1.5 | Reflow | 0.4 | 1.2-1.4 | 0.5 | 0.5 | 0.5 | | | | | | | | | | | | | | | | | | | | | | | | | | | | | | | | | | | | | | | | | | | | | | | | | | | | | | | | | | | | | | | | | | | | | | | | | | | | | | | | | | | | | | | | | | | | | | | | | | | | | | | | | | | | | | | | | | | | | | | | | | | | | | | | | | | | | | | | | | | | | | | | | | | | | | | | | | | | | | | | | |
| | 1.7-2.2 | | | | | 1.2 | 0.7 | | | | | | | | | | | | | | | | | | | | | | | | | | | | | | | | | | | | | | | | | | | | | | | | | | | | | | | | | | | | | | | | | | | | | | | | | | | | | | | | | | | | | | | | | | | | | | | | | | | | | | | | | | | | | | | | | | | | | | | | | | | | | | | | | | | | | | | | | | | | | | | | | | | | | | | | | | | | | | | | | |
| BLM15PD | 1 | Reflow | 0.4 | 1.2-1.4 | 0.5 | 0.5 | 0.5 | | | | | | | | | | | | | | | | | | | | | | | | | | | | | | | | | | | | | | | | | | | | | | | | | | | | | | | | | | | | | | | | | | | | | | | | | | | | | | | | | | | | | | | | | | | | | | | | | | | | | | | | | | | | | | | | | | | | | | | | | | | | | | | | | | | | | | | | | | | | | | | | | | | | | | | | | | | | | | | | | |
| BLM18PG | 0.5-1.5 | Flow/ Reflow | 0.7 | 2.2-2.6 Reflow 1.8-2.0 | 0.7 | 0.7 | 0.7 | | | | | | | | | | | | | | | | | | | | | | | | | | | | | | | | | | | | | | | | | | | | | | | | | | | | | | | | | | | | | | | | | | | | | | | | | | | | | | | | | | | | | | | | | | | | | | | | | | | | | | | | | | | | | | | | | | | | | | | | | | | | | | | | | | | | | | | | | | | | | | | | | | | | | | | | | | | | | | | | | |
| | 2 | | | | | 1.2 | 0.7 | | | | | | | | | | | | | | | | | | | | | | | | | | | | | | | | | | | | | | | | | | | | | | | | | | | | | | | | | | | | | | | | | | | | | | | | | | | | | | | | | | | | | | | | | | | | | | | | | | | | | | | | | | | | | | | | | | | | | | | | | | | | | | | | | | | | | | | | | | | | | | | | | | | | | | | | | | | | | | | | | |
| | 3 | | | | | 2.4 | 1.2 | | | | | | | | | | | | | | | | | | | | | | | | | | | | | | | | | | | | | | | | | | | | | | | | | | | | | | | | | | | | | | | | | | | | | | | | | | | | | | | | | | | | | | | | | | | | | | | | | | | | | | | | | | | | | | | | | | | | | | | | | | | | | | | | | | | | | | | | | | | | | | | | | | | | | | | | | | | | | | | | | |
| | 6 | | | | | 6.4 | 3.3 | | | | | | | | | | | | | | | | | | | | | | | | | | | | | | | | | | | | | | | | | | | | | | | | | | | | | | | | | | | | | | | | | | | | | | | | | | | | | | | | | | | | | | | | | | | | | | | | | | | | | | | | | | | | | | | | | | | | | | | | | | | | | | | | | | | | | | | | | | | | | | | | | | | | | | | | | | | | | | | | | |
| BLM18KG | 1.3-1.5 | Flow/ Reflow | 0.7 | 2.2-2.6 Reflow 1.8-2.0 | 0.7 | 0.7 | 0.7 | | | | | | | | | | | | | | | | | | | | | | | | | | | | | | | | | | | | | | | | | | | | | | | | | | | | | | | | | | | | | | | | | | | | | | | | | | | | | | | | | | | | | | | | | | | | | | | | | | | | | | | | | | | | | | | | | | | | | | | | | | | | | | | | | | | | | | | | | | | | | | | | | | | | | | | | | | | | | | | | | |
| | 1.7-2.2 | | | | | 1.2 | 0.7 | | | | | | | | | | | | | | | | | | | | | | | | | | | | | | | | | | | | | | | | | | | | | | | | | | | | | | | | | | | | | | | | | | | | | | | | | | | | | | | | | | | | | | | | | | | | | | | | | | | | | | | | | | | | | | | | | | | | | | | | | | | | | | | | | | | | | | | | | | | | | | | | | | | | | | | | | | | | | | | | | |
| | 3-3.5 | | | | | 2.4 | 1.2 | | | | | | | | | | | | | | | | | | | | | | | | | | | | | | | | | | | | | | | | | | | | | | | | | | | | | | | | | | | | | | | | | | | | | | | | | | | | | | | | | | | | | | | | | | | | | | | | | | | | | | | | | | | | | | | | | | | | | | | | | | | | | | | | | | | | | | | | | | | | | | | | | | | | | | | | | | | | | | | | | |
| | 6 | | | | | 6.4 | 3.3 | | | | | | | | | | | | | | | | | | | | | | | | | | | | | | | | | | | | | | | | | | | | | | | | | | | | | | | | | | | | | | | | | | | | | | | | | | | | | | | | | | | | | | | | | | | | | | | | | | | | | | | | | | | | | | | | | | | | | | | | | | | | | | | | | | | | | | | | | | | | | | | | | | | | | | | | | | | | | | | | | |
| BLM18SG | 1.5 | Flow/ Reflow | 1.2 | 3.0-4.0 | 1.0 | 0.7 | 0.7 | | | | | | | | | | | | | | | | | | | | | | | | | | | | | | | | | | | | | | | | | | | | | | | | | | | | | | | | | | | | | | | | | | | | | | | | | | | | | | | | | | | | | | | | | | | | | | | | | | | | | | | | | | | | | | | | | | | | | | | | | | | | | | | | | | | | | | | | | | | | | | | | | | | | | | | | | | | | | | | | | |
| | 2.5 | | | | | 1.2 | 0.7 | | | | | | | | | | | | | | | | | | | | | | | | | | | | | | | | | | | | | | | | | | | | | | | | | | | | | | | | | | | | | | | | | | | | | | | | | | | | | | | | | | | | | | | | | | | | | | | | | | | | | | | | | | | | | | | | | | | | | | | | | | | | | | | | | | | | | | | | | | | | | | | | | | | | | | | | | | | | | | | | | |
| | 3-4 | | | | | 2.4 | 1.2 | | | | | | | | | | | | | | | | | | | | | | | | | | | | | | | | | | | | | | | | | | | | | | | | | | | | | | | | | | | | | | | | | | | | | | | | | | | | | | | | | | | | | | | | | | | | | | | | | | | | | | | | | | | | | | | | | | | | | | | | | | | | | | | | | | | | | | | | | | | | | | | | | | | | | | | | | | | | | | | | | |
| | 6 | | | | | 6.4 | 3.3 | | | | | | | | | | | | | | | | | | | | | | | | | | | | | | | | | | | | | | | | | | | | | | | | | | | | | | | | | | | | | | | | | | | | | | | | | | | | | | | | | | | | | | | | | | | | | | | | | | | | | | | | | | | | | | | | | | | | | | | | | | | | | | | | | | | | | | | | | | | | | | | | | | | | | | | | | | | | | | | | | |
| BLM21PG | 1.5 | Flow/ Reflow | 2.0 | 4.2-5.2 | 1.2 | 1.0 | 1.0 | | | | | | | | | | | | | | | | | | | | | | | | | | | | | | | | | | | | | | | | | | | | | | | | | | | | | | | | | | | | | | | | | | | | | | | | | | | | | | | | | | | | | | | | | | | | | | | | | | | | | | | | | | | | | | | | | | | | | | | | | | | | | | | | | | | | | | | | | | | | | | | | | | | | | | | | | | | | | | | | | |
| | 2 | | | | | 1.2 | 1.0 | | | | | | | | | | | | | | | | | | | | | | | | | | | | | | | | | | | | | | | | | | | | | | | | | | | | | | | | | | | | | | | | | | | | | | | | | | | | | | | | | | | | | | | | | | | | | | | | | | | | | | | | | | | | | | | | | | | | | | | | | | | | | | | | | | | | | | | | | | | | | | | | | | | | | | | | | | | | | | | | | |
| | 3 | | | | | 2.4 | 1.2 | | | | | | | | | | | | | | | | | | | | | | | | | | | | | | | | | | | | | | | | | | | | | | | | | | | | | | | | | | | | | | | | | | | | | | | | | | | | | | | | | | | | | | | | | | | | | | | | | | | | | | | | | | | | | | | | | | | | | | | | | | | | | | | | | | | | | | | | | | | | | | | | | | | | | | | | | | | | | | | | | |
| | 6 | | | | | 6.4 | 3.3 | | | | | | | | | | | | | | | | | | | | | | | | | | | | | | | | | | | | | | | | | | | | | | | | | | | | | | | | | | | | | | | | | | | | | | | | | | | | | | | | | | | | | | | | | | | | | | | | | | | | | | | | | | | | | | | | | | | | | | | | | | | | | | | | | | | | | | | | | | | | | | | | | | | | | | | | | | | | | | | | | |
| BLM31PG | 1.5/2 | Flow/ Reflow | 3.0 | 5.5-6.5 | 1.2 | 1.2 | 1.2 | | | | | | | | | | | | | | | | | | | | | | | | | | | | | | | | | | | | | | | | | | | | | | | | | | | | | | | | | | | | | | | | | | | | | | | | | | | | | | | | | | | | | | | | | | | | | | | | | | | | | | | | | | | | | | | | | | | | | | | | | | | | | | | | | | | | | | | | | | | | | | | | | | | | | | | | | | | | | | | | | |
| | 3 | | | | | 2.4 | 1.2 | | | | | | | | | | | | | | | | | | | | | | | | | | | | | | | | | | | | | | | | | | | | | | | | | | | | | | | | | | | | | | | | | | | | | | | | | | | | | | | | | | | | | | | | | | | | | | | | | | | | | | | | | | | | | | | | | | | | | | | | | | | | | | | | | | | | | | | | | | | | | | | | | | | | | | | | | | | | | | | | | |
| | 6 | | | | | 6.4 | 3.3 | | | | | | | | | | | | | | | | | | | | | | | | | | | | | | | | | | | | | | | | | | | | | | | | | | | | | | | | | | | | | | | | | | | | | | | | | | | | | | | | | | | | | | | | | | | | | | | | | | | | | | | | | | | | | | | | | | | | | | | | | | | | | | | | | | | | | | | | | | | | | | | | | | | | | | | | | | | | | | | | | |
| BLM41PG | 1-2 | Flow/ Reflow | 3.0 | 5.5-6.5 | 1.2 | 1.2 | 1.2 | | | | | | | | | | | | | | | | | | | | | | | | | | | | | | | | | | | | | | | | | | | | | | | | | | | | | | | | | | | | | | | | | | | | | | | | | | | | | | | | | | | | | | | | | | | | | | | | | | | | | | | | | | | | | | | | | | | | | | | | | | | | | | | | | | | | | | | | | | | | | | | | | | | | | | | | | | | | | | | | | |
| | 3 | | | | | 2.4 | 1.2 | | | | | | | | | | | | | | | | | | | | | | | | | | | | | | | | | | | | | | | | | | | | | | | | | | | | | | | | | | | | | | | | | | | | | | | | | | | | | | | | | | | | | | | | | | | | | | | | | | | | | | | | | | | | | | | | | | | | | | | | | | | | | | | | | | | | | | | | | | | | | | | | | | | | | | | | | | | | | | | | | |
| | 6 | | | | | 6.4 | 3.3 | | | | | | | | | | | | | | | | | | | | | | | | | | | | | | | | | | | | | | | | | | | | | | | | | | | | | | | | | | | | | | | | | | | | | | | | | | | | | | | | | | | | | | | | | | | | | | | | | | | | | | | | | | | | | | | | | | | | | | | | | | | | | | | | | | | | | | | | | | | | | | | | | | | | | | | | | | | | | | | | | |

Continued on the following page. ↗

EMIFIL® (Soldering and Mounting)

Continued from the preceding page.

Land Pattern
 + Solder Resist
 Land Pattern
 Solder Resist
 (in mm)

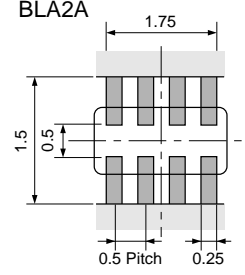
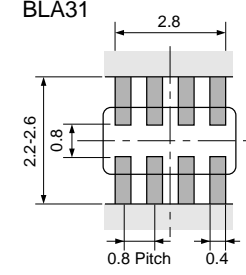
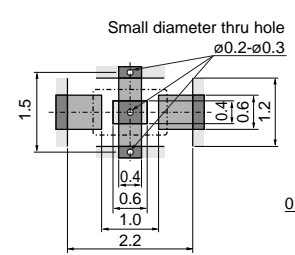
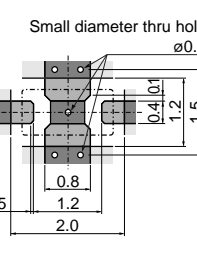
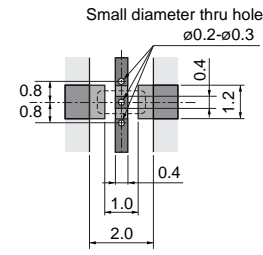
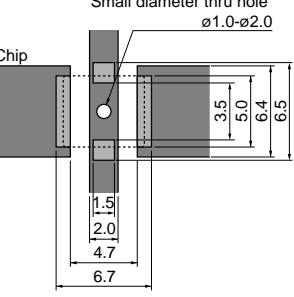
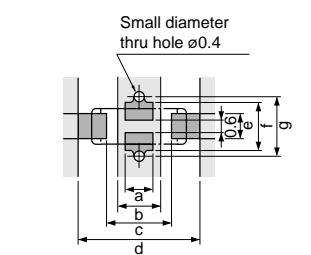
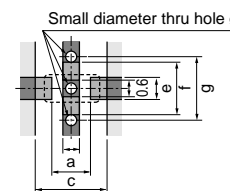
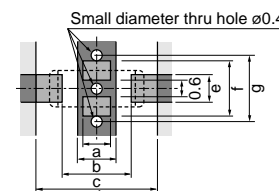
| <p>BLA2A BLA31</p> | <p>● Reflow soldering BLA2A</p>  <p>● Reflow and Flow BLA31</p>  <p>• If there are high amounts of self-heating on pattern, the contact points of PCB and part may become damaged.</p> | | | | | | | | | | | | | | | | | | | | | | | | | | | | | | | | | | | | | | | | | | | | | | | | | | | | | | | | | | | | | | | | | | | | | | | | | | | | | | | | | | | | | | | | | | | | | | | | | | | | | | | |
|---|---|---|-----------|-----|-----|-----|-----|--|--|---|---|---|---|---|---|---|---------------|-----|---|-----|-----|-----|-----|-----|---------------|-----|-----|-----|-----|-----|-----|-----|---------------|-----|-----|-----|-----|-----|-----|-----|--------|-----|-----|-----|-----|-----|-----|-----|--|-------------|-----------|--|--|--|--|--|--|---|---|---|---|---|---|---|--------|-----|-----|-----|-----|-----|-----|-----|--------|-----|-----|-----|-----|-----|-----|-----|--------|-----|-----|-----|-----|-----|-----|-----|--------|-----|-----|-----|-----|-----|-----|-----|--------|-----|-----|-----|-----|-----|-----|-----|
| <p>NFM18 NFL18 NFM55</p> | <p>Reflow Soldering NFM18C/NFM18PC/ NFL18ST</p>  <p>Small diameter thru hole $\phi 0.2\text{-}\phi 0.3$</p> <p>NFM18PS</p>  <p>Small diameter thru hole $\phi 0.2$</p> <p>NFL18SP</p>  <p>Small diameter thru hole $\phi 0.2\text{-}\phi 0.3$</p> <p>NFM55P</p>  <p>Small diameter thru hole $\phi 1.0\text{-}\phi 2.0$</p> <p>The chip EMI filter suppresses noise by conducting the high-frequency noise to ground. Therefore, to get enough noise reduction, feed through holes which are connected to ground-plane should be arranged according to the figure to reinforce the ground pattern.</p> <p>• NFM□18, NFM□21, NFM55 are specially adapted for reflow soldering.</p> <p>Please contact us if using thinner land pad than 18μm.</p> | <p>● Flow Soldering Chip mounting side</p>  <p>Small diameter thru hole $\phi 0.4$</p> | | | | | | | | | | | | | | | | | | | | | | | | | | | | | | | | | | | | | | | | | | | | | | | | | | | | | | | | | | | | | | | | | | | | | | | | | | | | | | | | | | | | | | | | | | | | | | | | | | | | | | |
| <p>NFM21 NFM3D NFM31P NFM41 NFR21G NFL21S</p> | <p>● Reflow Soldering Chip mounting side</p> <p>NFM21C/NFR21G NFM21P/NFL21S</p>  <p>Small diameter thru hole $\phi 0.4$</p> <p>NFM3DC/NFM3DP/ NFM31P NFM41C/NFM41P</p>  <p>Small diameter thru hole $\phi 0.4$</p> <table border="1" style="width: 100%; border-collapse: collapse; margin-top: 10px;"> <thead> <tr> <th rowspan="2">Part Number</th> <th colspan="7">Size (mm)</th> </tr> <tr> <th>a</th> <th>b</th> <th>c</th> <th>d</th> <th>e</th> <th>f</th> <th>g</th> </tr> </thead> <tbody> <tr> <td>NFM21C/NFR21G</td> <td>0.6</td> <td>-</td> <td>1.4</td> <td>2.6</td> <td>0.8</td> <td>1.9</td> <td>2.3</td> </tr> <tr> <td>NFM21P/NFL21S</td> <td>1.0</td> <td>1.4</td> <td>2.5</td> <td>4.4</td> <td>1.0</td> <td>2.0</td> <td>2.4</td> </tr> <tr> <td>NFM3DC/NFM3DP</td> <td>1.0</td> <td>1.4</td> <td>2.5</td> <td>4.4</td> <td>1.2</td> <td>2.6</td> <td>3.0</td> </tr> <tr> <td>NFM31P</td> <td>1.5</td> <td>2.0</td> <td>3.5</td> <td>6.0</td> <td>1.2</td> <td>2.6</td> <td>3.0</td> </tr> </tbody> </table> | Part Number | Size (mm) | | | | | | | a | b | c | d | e | f | g | NFM21C/NFR21G | 0.6 | - | 1.4 | 2.6 | 0.8 | 1.9 | 2.3 | NFM21P/NFL21S | 1.0 | 1.4 | 2.5 | 4.4 | 1.0 | 2.0 | 2.4 | NFM3DC/NFM3DP | 1.0 | 1.4 | 2.5 | 4.4 | 1.2 | 2.6 | 3.0 | NFM31P | 1.5 | 2.0 | 3.5 | 6.0 | 1.2 | 2.6 | 3.0 | <table border="1" style="width: 100%; border-collapse: collapse; margin-top: 10px;"> <thead> <tr> <th rowspan="2">Part Number</th> <th colspan="7">Size (mm)</th> </tr> <tr> <th>a</th> <th>b</th> <th>c</th> <th>d</th> <th>e</th> <th>f</th> <th>g</th> </tr> </thead> <tbody> <tr> <td>NFM3DC</td> <td>1.0</td> <td>1.4</td> <td>2.5</td> <td>4.4</td> <td>1.0</td> <td>2.0</td> <td>2.4</td> </tr> <tr> <td>NFM3DP</td> <td>1.0</td> <td>1.4</td> <td>2.5</td> <td>4.4</td> <td>1.2</td> <td>2.6</td> <td>3.0</td> </tr> <tr> <td>NFM31P</td> <td>1.0</td> <td>1.4</td> <td>2.5</td> <td>4.4</td> <td>1.2</td> <td>2.6</td> <td>3.0</td> </tr> <tr> <td>NFM41C</td> <td>1.5</td> <td>2.0</td> <td>3.5</td> <td>6.0</td> <td>1.2</td> <td>2.6</td> <td>3.0</td> </tr> <tr> <td>NFM41P</td> <td>1.5</td> <td>2.0</td> <td>3.5</td> <td>6.0</td> <td>1.2</td> <td>2.6</td> <td>3.0</td> </tr> </tbody> </table> | Part Number | Size (mm) | | | | | | | a | b | c | d | e | f | g | NFM3DC | 1.0 | 1.4 | 2.5 | 4.4 | 1.0 | 2.0 | 2.4 | NFM3DP | 1.0 | 1.4 | 2.5 | 4.4 | 1.2 | 2.6 | 3.0 | NFM31P | 1.0 | 1.4 | 2.5 | 4.4 | 1.2 | 2.6 | 3.0 | NFM41C | 1.5 | 2.0 | 3.5 | 6.0 | 1.2 | 2.6 | 3.0 | NFM41P | 1.5 | 2.0 | 3.5 | 6.0 | 1.2 | 2.6 | 3.0 |
| Part Number | Size (mm) | | | | | | | | | | | | | | | | | | | | | | | | | | | | | | | | | | | | | | | | | | | | | | | | | | | | | | | | | | | | | | | | | | | | | | | | | | | | | | | | | | | | | | | | | | | | | | | | | | | | | | | |
| | a | b | c | d | e | f | g | | | | | | | | | | | | | | | | | | | | | | | | | | | | | | | | | | | | | | | | | | | | | | | | | | | | | | | | | | | | | | | | | | | | | | | | | | | | | | | | | | | | | | | | | | | | | | | | | |
| NFM21C/NFR21G | 0.6 | - | 1.4 | 2.6 | 0.8 | 1.9 | 2.3 | | | | | | | | | | | | | | | | | | | | | | | | | | | | | | | | | | | | | | | | | | | | | | | | | | | | | | | | | | | | | | | | | | | | | | | | | | | | | | | | | | | | | | | | | | | | | | | | | |
| NFM21P/NFL21S | 1.0 | 1.4 | 2.5 | 4.4 | 1.0 | 2.0 | 2.4 | | | | | | | | | | | | | | | | | | | | | | | | | | | | | | | | | | | | | | | | | | | | | | | | | | | | | | | | | | | | | | | | | | | | | | | | | | | | | | | | | | | | | | | | | | | | | | | | | |
| NFM3DC/NFM3DP | 1.0 | 1.4 | 2.5 | 4.4 | 1.2 | 2.6 | 3.0 | | | | | | | | | | | | | | | | | | | | | | | | | | | | | | | | | | | | | | | | | | | | | | | | | | | | | | | | | | | | | | | | | | | | | | | | | | | | | | | | | | | | | | | | | | | | | | | | | |
| NFM31P | 1.5 | 2.0 | 3.5 | 6.0 | 1.2 | 2.6 | 3.0 | | | | | | | | | | | | | | | | | | | | | | | | | | | | | | | | | | | | | | | | | | | | | | | | | | | | | | | | | | | | | | | | | | | | | | | | | | | | | | | | | | | | | | | | | | | | | | | | | |
| Part Number | Size (mm) | | | | | | | | | | | | | | | | | | | | | | | | | | | | | | | | | | | | | | | | | | | | | | | | | | | | | | | | | | | | | | | | | | | | | | | | | | | | | | | | | | | | | | | | | | | | | | | | | | | | | | | |
| | a | b | c | d | e | f | g | | | | | | | | | | | | | | | | | | | | | | | | | | | | | | | | | | | | | | | | | | | | | | | | | | | | | | | | | | | | | | | | | | | | | | | | | | | | | | | | | | | | | | | | | | | | | | | | | |
| NFM3DC | 1.0 | 1.4 | 2.5 | 4.4 | 1.0 | 2.0 | 2.4 | | | | | | | | | | | | | | | | | | | | | | | | | | | | | | | | | | | | | | | | | | | | | | | | | | | | | | | | | | | | | | | | | | | | | | | | | | | | | | | | | | | | | | | | | | | | | | | | | |
| NFM3DP | 1.0 | 1.4 | 2.5 | 4.4 | 1.2 | 2.6 | 3.0 | | | | | | | | | | | | | | | | | | | | | | | | | | | | | | | | | | | | | | | | | | | | | | | | | | | | | | | | | | | | | | | | | | | | | | | | | | | | | | | | | | | | | | | | | | | | | | | | | |
| NFM31P | 1.0 | 1.4 | 2.5 | 4.4 | 1.2 | 2.6 | 3.0 | | | | | | | | | | | | | | | | | | | | | | | | | | | | | | | | | | | | | | | | | | | | | | | | | | | | | | | | | | | | | | | | | | | | | | | | | | | | | | | | | | | | | | | | | | | | | | | | | |
| NFM41C | 1.5 | 2.0 | 3.5 | 6.0 | 1.2 | 2.6 | 3.0 | | | | | | | | | | | | | | | | | | | | | | | | | | | | | | | | | | | | | | | | | | | | | | | | | | | | | | | | | | | | | | | | | | | | | | | | | | | | | | | | | | | | | | | | | | | | | | | | | |
| NFM41P | 1.5 | 2.0 | 3.5 | 6.0 | 1.2 | 2.6 | 3.0 | | | | | | | | | | | | | | | | | | | | | | | | | | | | | | | | | | | | | | | | | | | | | | | | | | | | | | | | | | | | | | | | | | | | | | | | | | | | | | | | | | | | | | | | | | | | | | | | | |

Continued on the following page. ↗

EMIFIL® (Soldering and Mounting)

Continued from the preceding page.

Land Pattern
 + Solder Resist
 Land Pattern
 Solder Resist

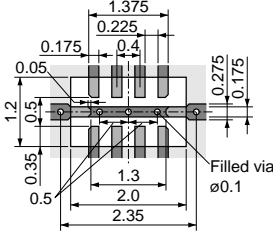
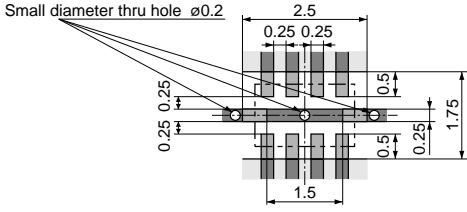
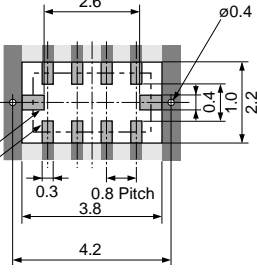
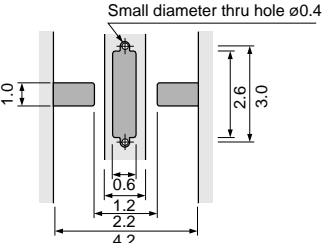
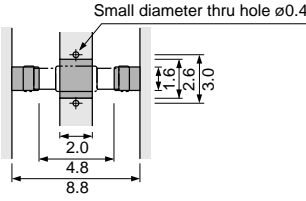
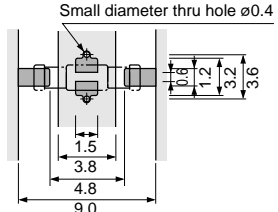
| <p>NFA18S NFA21S</p> | <p>Reflow Soldering Chip mounting side</p> <p style="text-align: center;">NFA18S</p>  | <p style="text-align: center;">NFA21S</p>  |
|--|--|--|
| <p>NFA31G NFA31C NFW31S NFE31P</p> | <ul style="list-style-type: none"> ● Reflow Soldering NFA31G/31C  <p>R0.1 to R0.2 is preferred to obtain high voltage withstanding</p> | <ul style="list-style-type: none"> ● Reflow and Flow NFW31S ● Reflow Soldering NFE31P <p>Chip mounting side</p>  |
| <p>NFE61P</p> | <ul style="list-style-type: none"> ● Reflow Soldering <p>Chip mounting side</p>  | <ul style="list-style-type: none"> ● Flow Soldering <p>Chip mounting side</p>  |

Continued on the following page.

EMIFIL[®] (Soldering and Mounting)

Continued from the preceding page.

Land Pattern
 + Solder Resist
 Land Pattern
 Solder Resist
 (in mm)

DLM11G
DLM2HG
DLP0NS
DLP11S
DLP2AD
DLP31S
DLP31D
DLW21S
DLW21H
DLW31S
DLW5AH
DLW5BS
DLW5BT

●Reflow and Flow

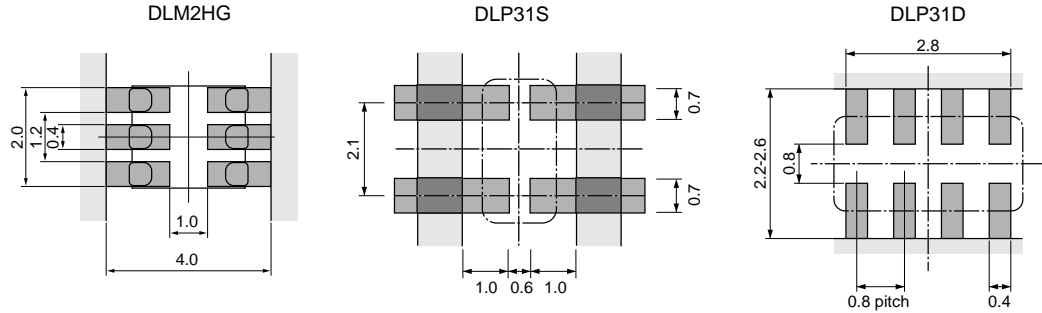

●Reflow Soldering

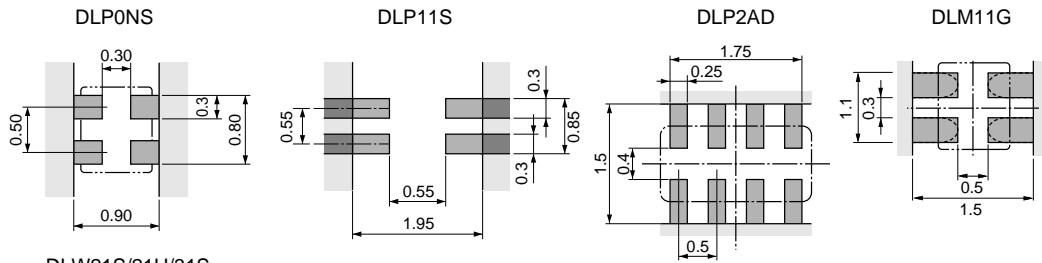

DLW21S/21H/31S

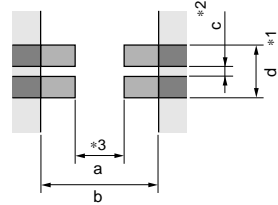

DLW5AH/5BS/5BT

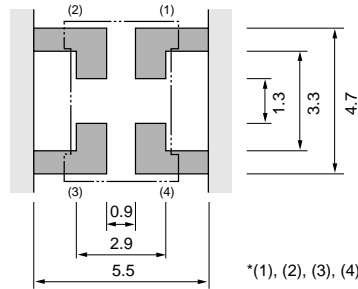

*(1), (2), (3), (4): Terminal Number

| Series | a | b | c | d |
|----------|-----|-----|-----|-----|
| DLW21S/H | 0.8 | 2.6 | 0.4 | 1.2 |
| DLW31S | 1.6 | 3.7 | 0.4 | 1.6 |

- * 1: If the pattern is made with wider than 1.2mm (DLW21) / 1.6mm (DLW31S) it may result in components turning around, because melting speed is different. In the worst case, short circuit between lines may occur.
- * 2: If the pattern is made with less than 0.4mm, in the worst case, short circuit between lines may occur due to spread of soldering paste or mount placing accuracy.
- * 3: If the pattern is made with wider than 0.8mm (DLW21) / 1.6mm (DLW31S), the bending strength will be reduced. Do not use gild pattern; excess soldering heat may dissolve metal of a copper wire.

Continued on the following page. ↗

EMIFIL® (Soldering and Mounting)

Continued from the preceding page.

Land Pattern
 + Solder Resist
 Land Pattern
 Through Hole

BNX022
BNX033

- (1) A double-sided print board (or multilayer board) as shown in the left figure is designed, and please apply a soldering Cu electrode with a product electrode to a "Land Pattern", apply resist to a "Land Pattern + Solder Resist" at Cu electrode.
- (2) Please drop CG on a ground electrode on the back layer (the same also in a multilayer case) by the through hole. And a surface ground electrode layer may also take a large area as much as possible.
- (3) It is recommended to use a double-sided printed circuit board with BNX mounting on one side and the ground pattern on the other in order to maximize filtering performance, multiple feed through holes are required to maximize the BNX's connection to ground.
- (4) The ground pattern should be designed to be as large as possible to achieve maximum filtering performance.

2. Solder Paste Printing and Adhesive Application

When reflow soldering the chip EMI suppression filter, the printing must be conducted in accordance with the following cream solder printing conditions.

If too much solder is applied, the chip will be prone to damage by mechanical and thermal stress from the PCB and may crack.

Standard land dimensions should be used for resist and copper foil patterns.

When flow soldering the EMI suppression filter, apply the adhesive in accordance with the following conditions.

If too much adhesive is applied, then it may overflow into the land or termination areas and yield poor solderability. In contrast, if insufficient adhesive is applied, or if the adhesive is not sufficiently hardened, then the chip may become detached during flow soldering process.

(in mm)

| Series | Solder Paste Printing | Adhesive Application |
|--|---|--|
| <p>BLM (Except BLM 15A_AN series)</p> | <ul style="list-style-type: none"> ● Ensure that solder is applied smoothly to a minimum height of 0.2mm to 0.3mm at the end surface of the part. ● Coat with solder paste to the following thickness: 50-80μm: BLM02 100-150μm: BLM03 100-200μm: BLM15/18/21/31/41 | <p>Coating amount is illustrated in the following diagram.</p> <p style="text-align: right; font-size: small;"> a: 20-70μm b: 30-35μm c: 50-105μm </p> |
| <p>BLA</p> | <ul style="list-style-type: none"> ● Use Sn/Pb=60/40 or Sn-3.0Ag-0.5Cu solder for pattern printing. Use of Sn-Zn based solder will deteriorate performance of products. In case of using Sn-Zn based solder, please contact Murata in advance. ● Coat with solder paste to the following thickness: 100-150μm: BLA2A 150-200μm: BLA31 <div style="display: flex; justify-content: space-around; align-items: flex-end;"> <div style="text-align: center;"> <p>BLA31</p> </div> <div style="text-align: center;"> <p>BLA2A</p> </div> </div> | <p>BLA31 Series only Coating amount is illustrated in the following diagram.</p> <p style="text-align: right; font-size: small;"> a: 20-70μm b: 30-35μm c: 50-105μm </p> |

Continued on the following page.

EMIFIL[®] (Soldering and Mounting)

Continued from the preceding page.

(in mm)

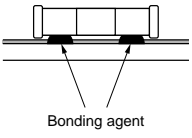
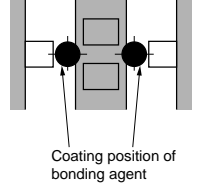
| Series | Solder Paste Printing | Adhesive Application |
|--|--|---|
| NFM NFR NFL | <ul style="list-style-type: none"> ● Use Sn/Pb=60/40 or Sn-3.0Ag-0.5Cu solder for pattern printing. Use of Sn-Zn based solder will deteriorate performance of products. If using NFM series with Sn-Zn based solder, please contact Murata in advance. ● Coat with solder paste to the following thickness: 100-150μm: NFM18/21/3D/31P, NFR, NFL 150-200μm: NFM55P 100-200μm: NFM41 <div style="display: flex; justify-content: space-around;"> <div style="text-align: center;"> <p>NFM18C/18PC NFL18ST</p> </div> <div style="text-align: center;"> <p>NFL18SP</p> </div> <div style="text-align: center;"> <p>NFM21C/21P NFR21G/NFL21S</p> </div> </div> <div style="text-align: center; margin-top: 10px;"> <p>NFM18PS</p> </div> <div style="display: flex; justify-content: space-around; margin-top: 10px;"> <div style="text-align: center;"> <p>NFM3DC/3DP</p> </div> <div style="text-align: center;"> <p>NFM31P</p> </div> </div> <div style="display: flex; justify-content: space-around; margin-top: 10px;"> <div style="text-align: center;"> <p>NFM41C/41P</p> </div> <div style="text-align: center;"> <p>NFM55P</p> </div> </div> | <p>Apply 0.1mg for NFM41C/41P and 0.06mg for NFM3D/NFM31PC of bonding agent at each chip. Do not cover electrodes.</p> <div style="display: flex; justify-content: space-around; align-items: center;">   </div> |

Continued on the following page. ↗

EMIFIL® (Soldering and Mounting)

Continued from the preceding page.

(in mm)

| Series | Solder Paste Printing | Adhesive Application |
|--|--|---|
| <p>NFA</p> | <ul style="list-style-type: none"> ●Use Sn/Pb=60/40 or Sn-3.0Ag-0.5Cu solder for pattern printing. ●Coat with solder paste to the following thickness: 100-200μm: NFA31G/31C 100-150μm: NFA18S/21S <div style="display: flex; justify-content: space-around;"> <div style="text-align: center;"> <p>NFA31G/31C</p> </div> <div style="text-align: center;"> <p>NFA21S</p> </div> </div> <div style="text-align: center; margin-top: 10px;"> <p>NFA18S</p> </div> | |
| <p>NFW31S NFE31P</p> | <ul style="list-style-type: none"> ●Use Sn/Pb=60/40 or Sn-3.0Ag-0.5Cu solder for pattern printing. ●Coat with solder paste to the following thickness: 150-200μm <div style="text-align: center;"> </div> | <p>NFW31S Series Apply 0.2mg of bonding agent at each chip.</p> <div style="display: flex; justify-content: space-around; align-items: center;"> </div> |
| <p>NFE61P</p> | <ul style="list-style-type: none"> ●Use Sn/Pb=60/40 or Sn-3.0Ag-0.5Cu solder for pattern printing. ●Coat with solder paste to the following thickness: 150-200μm <div style="text-align: center;"> </div> | <p>Apply 1.0mg of bonding agent at each chip.</p> <div style="display: flex; justify-content: space-around; align-items: center;"> </div> |

Continued on the following page. ↗

EMIFIL® (Soldering and Mounting)

Continued from the preceding page.

(in mm)

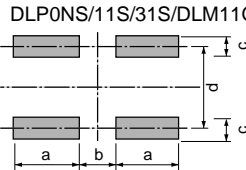
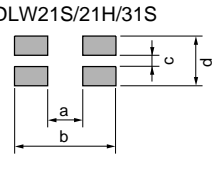
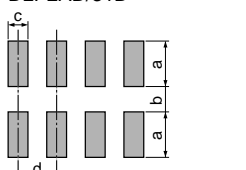
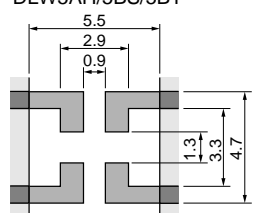
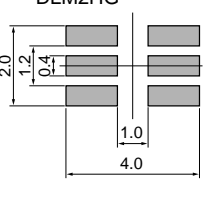
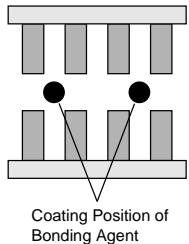
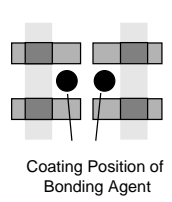
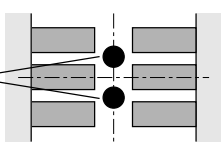
| Series | Solder Paste Printing | Adhesive Application | | | | | | | | | | | | | | | | | | | | | | | | | | | | | | | | | | | | | | | | |
|--|---|----------------------|------|------|---|---|--------|-----|-----|-----|-----|--------|-----|------|-----|------|--------|-----|-----|-----|-----|--------|-----|-----|-----|-----|--------|---|---|---|---|--------|------|-----|------|-----|--------|-----|-----|-----|-----|--|
| DLP DLW DLM | <p>●Use Sn/Pb=60/40 or Sn-3.0Ag-0.5Cu solder for pattern printing. Use of Sn-Zn based solder will deteriorate performance of products. If using DLP/DLM series with Sn-Zn based solder, please contact Murata in advance.</p> <p>●Coat with solder paste to the following thickness: 100-150μm: DLW21S/21H/31S, DLP0NS/11S/2AD 150-200μm: DLP31D/31S, DLM2HG, DLW5AH/5BS/5BT</p> <p>*Solderability is subject to reflow conditions and thermal conductivity. Please make sure that your product has been evaluated in view of your specifications with our product being mounted to your product.</p> <div style="display: flex; justify-content: space-around;"> <div style="text-align: center;"> <p>DLP0NS/11S/31S/DLM11G</p>  </div> <div style="text-align: center;"> <p>DLW21S/21H/31S</p>  </div> </div> <table border="1" style="width: 100%; border-collapse: collapse; margin-top: 10px;"> <thead> <tr> <th>Series</th> <th>a</th> <th>b</th> <th>c</th> <th>d</th> </tr> </thead> <tbody> <tr> <td>DLP0NS</td> <td>0.3</td> <td>0.3</td> <td>0.3</td> <td>0.5</td> </tr> <tr> <td>DLP11S</td> <td>0.7</td> <td>0.55</td> <td>0.3</td> <td>0.55</td> </tr> <tr> <td>DLP31S</td> <td>1.0</td> <td>0.6</td> <td>0.7</td> <td>2.1</td> </tr> <tr> <td>DLM11G</td> <td>0.5</td> <td>0.5</td> <td>0.4</td> <td>0.7</td> </tr> </tbody> </table> <div style="display: flex; justify-content: space-around; margin-top: 10px;"> <div style="text-align: center;"> <p>DLP2AD/31D</p>  </div> <div style="text-align: center;"> <table border="1" style="width: 100%; border-collapse: collapse;"> <thead> <tr> <th>Series</th> <th>a</th> <th>b</th> <th>c</th> <th>d</th> </tr> </thead> <tbody> <tr> <td>DLP2AD</td> <td>0.55</td> <td>0.4</td> <td>0.25</td> <td>0.5</td> </tr> <tr> <td>DLP31D</td> <td>1.0</td> <td>0.8</td> <td>0.4</td> <td>0.8</td> </tr> </tbody> </table> </div> </div> <div style="display: flex; justify-content: space-around; margin-top: 10px;"> <div style="text-align: center;"> <p>DLW5AH/5BS/5BT</p>  </div> <div style="text-align: center;"> <p>DLM2HG</p>  </div> </div> | Series | a | b | c | d | DLP0NS | 0.3 | 0.3 | 0.3 | 0.5 | DLP11S | 0.7 | 0.55 | 0.3 | 0.55 | DLP31S | 1.0 | 0.6 | 0.7 | 2.1 | DLM11G | 0.5 | 0.5 | 0.4 | 0.7 | Series | a | b | c | d | DLP2AD | 0.55 | 0.4 | 0.25 | 0.5 | DLP31D | 1.0 | 0.8 | 0.4 | 0.8 | <p>DLP31S/DLM2HG Apply 0.3mg of bonding agent at each chip.</p> <div style="display: flex; justify-content: space-around; margin-top: 20px;"> <div style="text-align: center;"> <p>DLP31D</p>  <p>Coating Position of Bonding Agent</p> </div> <div style="text-align: center;"> <p>DLP31S</p>  <p>Coating Position of Bonding Agent</p> </div> </div> <div style="text-align: center; margin-top: 20px;"> <p>DLM2HG</p>  <p>Coating Position of Bonding Agent</p> </div> |
| Series | a | b | c | d | | | | | | | | | | | | | | | | | | | | | | | | | | | | | | | | | | | | | | |
| DLP0NS | 0.3 | 0.3 | 0.3 | 0.5 | | | | | | | | | | | | | | | | | | | | | | | | | | | | | | | | | | | | | | |
| DLP11S | 0.7 | 0.55 | 0.3 | 0.55 | | | | | | | | | | | | | | | | | | | | | | | | | | | | | | | | | | | | | | |
| DLP31S | 1.0 | 0.6 | 0.7 | 2.1 | | | | | | | | | | | | | | | | | | | | | | | | | | | | | | | | | | | | | | |
| DLM11G | 0.5 | 0.5 | 0.4 | 0.7 | | | | | | | | | | | | | | | | | | | | | | | | | | | | | | | | | | | | | | |
| Series | a | b | c | d | | | | | | | | | | | | | | | | | | | | | | | | | | | | | | | | | | | | | | |
| DLP2AD | 0.55 | 0.4 | 0.25 | 0.5 | | | | | | | | | | | | | | | | | | | | | | | | | | | | | | | | | | | | | | |
| DLP31D | 1.0 | 0.8 | 0.4 | 0.8 | | | | | | | | | | | | | | | | | | | | | | | | | | | | | | | | | | | | | | |

Continued on the following page. ↗

EMIFIL® (Soldering and Mounting)

Continued from the preceding page.

| Series | Solder Paste Printing | Adhesive Application |
|--------------------------------|---|----------------------|
| BNX022 BNX023 | <ul style="list-style-type: none"> ● Use Sn/Pb=60/40 or Sn-3.0Ag-0.5Cu solder for pattern printing. ● Coat with solder paste to the following thickness: 150-200μm <div style="text-align: center;"> </div> | |

3. Standard Soldering Conditions

(1) Soldering Methods

- Use flow and reflow soldering methods only.
- Use standard soldering conditions when soldering chip EMI suppression filters.
- In cases where several different parts are soldered, each having different soldering conditions, use those conditions requiring the least heat and minimum time.

Solder: H60A H63A solder (JIS Z 3238)

- In case of lead-free solder, use Sn-3.0Ag-0.5Cu solder. Use of Sn-Zn based solder will deteriorate performance of products.
- If using BLA/NFM/DLP/DLM series with Sn-Zn based solder, please contact Murata in advance.

Flux:

- Use Rosin-based flux.
 - In case of DLW21/31 series, use Rosin-based flux with converting chlorine content of 0.06 to 0.1wt%.
 - In case of using RA type solder, products should be cleaned completely with no residual flux.
- Do not use strong acidic flux (with chlorine content exceeding 0.20wt%)
- Do not use water-soluble flux.

For additional mounting methods, please contact Murata.

(2) Soldering profile

- Flow Soldering profile
(Eutectic solder, Sn-3.0Ag-0.5Cu solder)

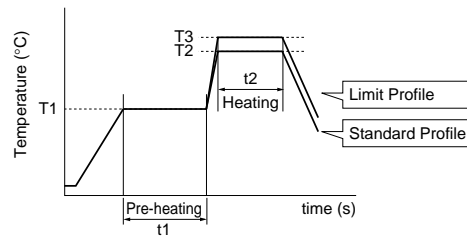

| Series | Pre-heating | | Standard Profile | | | Limit Profile | | |
|---|-------------|------------|------------------|------------|---------------|---------------|------------|---------------|
| | Temp. (T1) | Time. (t1) | Heating | | Cycle of flow | Heating | | Cycle of flow |
| | | | Temp. (T2) | Time. (t2) | | Temp. (T3) | Time. (t2) | |
| BLM (Except BLM02/03/15/18G) BLA31 NFM3DC/3DP/31PC NFM41C/41P NFE61P DLM2HG DLP31D/31S | 150°C | 60s min. | 250°C | 4 to 6s | 2 times max. | 265±3°C | 5s max. | 2 times max. |
| NFW31S | 150°C | 60s min. | 250°C | 4 to 6s | 2 times max. | 265±3°C | 5s max. | 1 times |

Continued on the following page. ↗

EMIFIL[®] (Soldering and Mounting)

Continued from the preceding page.

●Reflow Soldering profile

①Soldering profile for Lead-free solder (Sn-3.0Ag-0.5Cu)

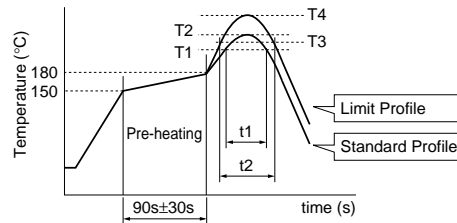

| Series | Standard Profile | | | | Limit Profile | | | |
|---|------------------|------------|-----------------------|-----------------|---------------|------------|-----------------------|-----------------|
| | Heating | | Peak temperature (T2) | Cycle of reflow | Heating | | Peak temperature (T4) | Cycle of reflow |
| | Temp. (T1) | Time. (t1) | | | Temp. (T3) | Time. (t2) | | |
| BLM, BLA NFA, NFE NFL, NFM (Except NFM55P) NFR, DLM DLP DLW21/31 | 220°C min. | 30 to 60s | 245±3°C | 2 times max. | 230°C min. | 60s max. | 260°C/10s | 2 times max. |
| DLW5A/5B | 220°C min. | 30 to 60s | 250±3°C | 2 times max. | 230°C min. | 60s max. | 260°C/10s | 2 times max. |
| NFW31S, NFM55P | 220°C min. | 30 to 60s | 245±3°C | 2 times max. | 230°C min. | 60s max. | 260°C/10s | 1 times |
| BNX022/023 | 220°C min. | 30 to 60s | 250±3°C | 2 times max. | 230°C min. | 60s max. | 260°C/10s | 2 times max. |

②Soldering profile for Eutectic solder (Limit profile: refer to ①)

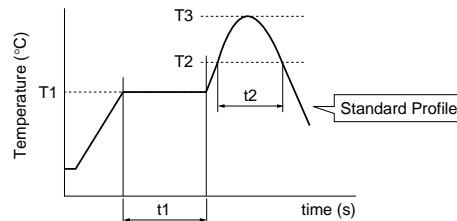

| Series | Pre-heating | | Standard Profile | | | |
|---|-------------|------------|------------------|------------|-----------------------|-----------------|
| | Temp. (T1) | Time. (t1) | Heating | | Peak temperature (T3) | Cycle of reflow |
| | | | Temp. (T2) | Time. (t2) | | |
| BLM, BLA NFA, NFE NFL, NFM NFR, NFW DLM, DLP DLW, BNX022/023 | 150°C | 60s min. | 183°C min. | 60s max. | 230°C | 2 times max. |

(3) Reworking with Solder Iron

The following conditions must be strictly followed when using a soldering iron.

Pre-heating: 150°C 60s min.*1

*1 NFM55P: 100°C/60s+200°C/60s

Soldering iron power output: 30W max.*2

*2 BNX022/023: 100W max.

Temperature of soldering iron tip / Soldering time: 350°C max./3s max.*3

*3 NFE31PT152Z1E9: 280°C max./10s max.

BNX022/023: 450°C max./5s max./1 times

Do not allow the tip of the soldering iron to directly contact the chip.

For additional methods of reworking with a soldering iron, please contact Murata engineering.

Continued on the following page.

EMIFIL® (Soldering and Mounting)

Continued from the preceding page.

4. Cleaning

Following conditions should be observed when cleaning chip EMI filter.

- (1) Cleaning Temperature: 60°C max. (40°C max. for alcohol type cleaner)
- (2) Ultrasonic
Output: 20W/liter max.
Duration: 5 minutes max.
Frequency: 28 to 40kHz
- (3) Cleaning agent
The following list of cleaning agents have been tested on the individual components. Evaluation of final assembly should be completed prior to production.

Do not clean DLW21S/31S/5AH/5BS/5BT/BNX022/023 series.

Before cleaning, please contact Murata engineering.

- (a) Alcohol cleaning agent
Isopropyl alcohol (IPA)
 - (b) Aqueous cleaning agent
Pine Alpha ST-100S
- (4) Ensure that flux residue is completely removed.
Component should be thoroughly dried after aqueous agent has been removed with deionized water.
 - (5) Some products may become slightly whitened.
However, product performance or usage is not affected.
For additional cleaning methods, please contact Murata engineering.

5. Mounting of BLM15A_AN Series

BLM15A_AN is series for wire bonding mounting.

(1) Die bonding mounting

(a) Dimension of standard metal mask

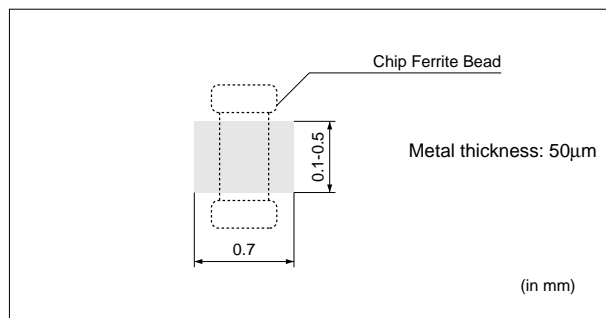

(b) Die bonding agent

- Use adhesive for die bonding for which the curing temperature is 200°C or less.

(c) Notice

- Use a flat surface of substrate for bonding mounting.
Slant mounting of product may affect the wire bonding.
- Adhesive for die bonding may affect the mounting reliability in wire bonding.
Make sure of the mounting reliability with the adhesive to be used in advance.

Lead Type EMIFIL® (Soldering and Mounting)

1. Mounting Hole

Mounting holes should be designed as specified below.

| Part number | Bulk type (in mm) | Taping type (in mm) |
|--------------------------------|-----------------------|--|
| DSN6 DSS6 VFR3V VFS6V | | |
| DSN9 DSN9H | | |
| DST9 DST9H | | |
| DSS9 DSS9H VFS9V | | |
| BNX00□/01□ | <p>Component Side</p> | <p>TERMINAL LAYOUT (Bottom figure)</p> <p>PSG: Power supply ground CG: Load circuit ground CB: Load circuit + Bias</p> |

Continued on the following page. ↗

Lead Type EMIFIL® (Soldering and Mounting)

Continued from the preceding page.

2. Using The Block Type EMIFIL® Effectively

(1) How to use effectively

This product effectively prevents undesired radiation and external noise from going out / entering the circuit by grounding the high frequency components which cause noise problems. Therefore, grounding conditions may affect the performance of the filter and attention should be paid to the following for effective use.

- Design maximized grounding area in the P.C. board, and grounding pattern for all the grounding terminals of the product to be connected. (Please follow the specified recommendations.)
- Minimize the distance between ground of the P.C. board and the ground plate of the product. (Recommend using the through hole connection between grounding area both of component side and bottom side.)
- Insert the terminals into the holes on P.C. board completely.
- Don't connect PSG terminal with CG terminal directly. (See the item 1. Terminal Layout)

(2) Self-heating

Though this product has a large rated current, localized selfheating may be caused depending on soldering conditions. To avoid this, attention should be paid to the following:

- Use P.C. board with our recommendation on hole diameter / land pattern dimensions, mentioned in the right hand drawing, especially for 4 terminals which pass current.
- Solder the terminals to the P.C. board with soldercover area at least 90%. Otherwise, excess self-heating at connection between terminals and P.C. board may lead to smoke and / or fire of the product even when operating at rated current.
- After installing this product in your product, please make sure the self-heating is within the rated current recommended.

P. C. BOARD PATTERNS

Use a bilateral P.C. board. Insert the BNX into the P.C.board until the root of the terminal is secured, then solder.

(1) COMPONENT SIDE VIEW (2) BOTTOM VIEW

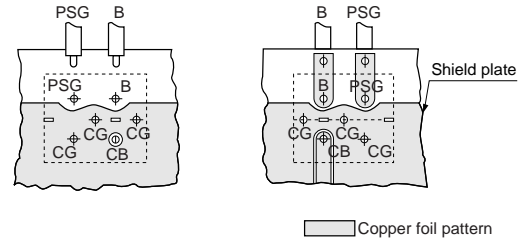

Recommended land pattern

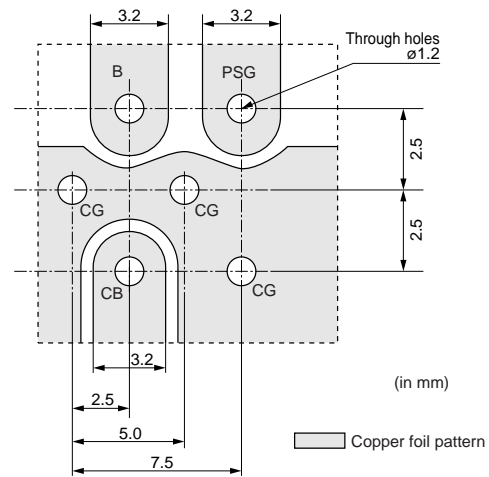

Continued on the following page. ↗

Lead Type EMIFIL[®] (Soldering and Mounting)

☒ Continued from the preceding page.

3. Using EMIGUARD[®] effectively

- (1) Terminal (with mark) should be properly connected to the line of incoming electrostatic surge. (There is polarity.) Otherwise, no effect in ESD suppression can be expected (VFR3V).
- (2) Products should be used at rated voltage or less and rated current or less.
- (3) Products should not be applied for the absorption of surges which have large energy (ex. induced lightning surges, switching surges) because it is designed for the absorption of electrostatic surges (VFR3V).
- (4) Electrostatic test should be done on the following conditions (VFR3V).
 - $n \cdot [C / R \cdot V^2]^2 < 8.0 \times 10^5$
 - n: Times applied
 - C: Charging Capacitance (pF)
 - V: Testing Voltage (kV)
 - R: Charging Resistance (Ω)

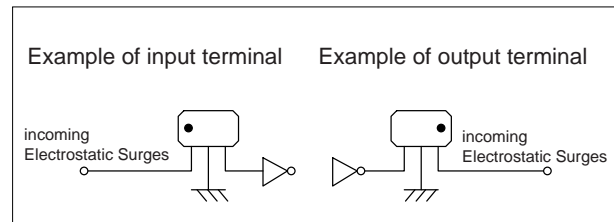

4. Soldering

- (1) Solder: H60A, H63A solder (JIS Z 3238)
In case of lead-free solder, use Sn-3.0Ag-0.5Cu solder.
- (2) Use Rosin-based flux. Do not use strong acidic flux with halide content exceeding 0.2wt% (chlorine conversion value).
- (3) Products and the leads should not be subjected to any mechanical stress during the soldering process, or while subjected to the equivalent high temperatures.
- (4) Standard flow soldering profile

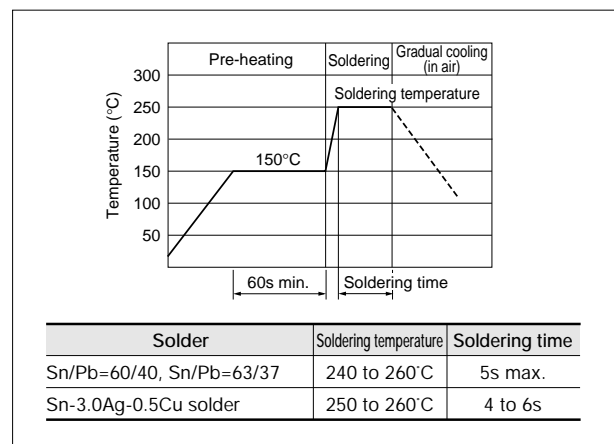

5. Cleaning Conditions

Do not clean VFR3V, PLT09H and VFS6V series.
Clean other parts in the following conditions.

- (1) Cleaning temperature should be limited to 60°C max. (40°C max for alcohol type cleaner).
- (2) Ultrasonic cleaning should comply with the following conditions, avoiding the resonance phenomenon at the mounted products and P.C.B.
Power: 20 W / l max. Frequency: 28 to 40kHz
Time: 5 min. max.
- (3) Cleaner
 - (a) Alcohol type cleaner
Isopropyl alcohol (IPA)

(b) Aqueous agent (PLT series cannot be cleaned)
PINE ALPHA ST-100S

- (4) There should be no residual flux or residual cleaner left after cleaning.
In the case of using aqueous agent, products should be dried completely after rinsing with de-ionized water in order to remove the cleaner.
- (5) The surface of products may become dirty after cleaning, but there is no deterioration on mechanical, electrical characteristics and reliability.
- (6) Other cleaning: Please contact us.

Chip EMIFIL[®] Packaging

■ Minimum Quantity and Dimensions of 8mm Width Paper / Embossed Tape

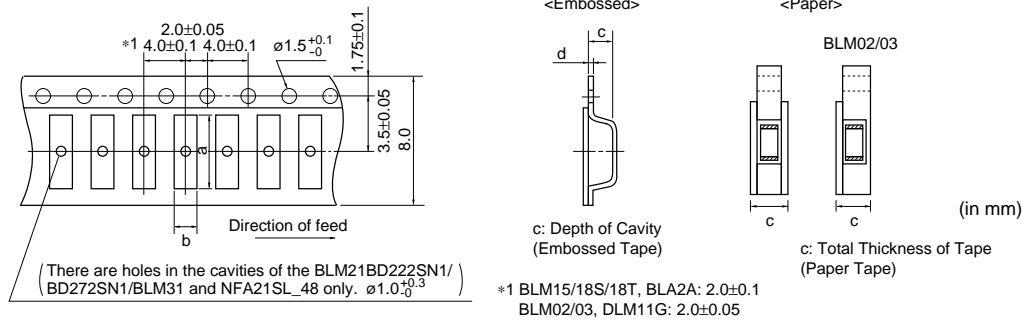

| Part Number | Cavity Size (in mm) | | | | Minimum Qty. (pcs.) | | | | |
|---|---------------------|------|-----------|------|---------------------|---------------|-------------|---------------|------|
| | | | | | ø180mm reel | | ø330mm reel | | Bulk |
| | a | b | c | d | Paper Tape | Embossed Tape | Paper Tape | Embossed Tape | |
| BLM02 | 0.45 | 0.25 | 0.40 max. | - | 20000 | - | - | - | 1000 |
| BLM03 | 0.70 | 0.40 | 0.55 max. | - | 15000 | - | 50000 | - | 1000 |
| BLM15 | 1.15 | 0.65 | 0.8 max. | - | 10000 | - | 50000 | - | 1000 |
| BLM18 | 1.85 | 1.05 | 1.1 max. | - | 4000 | - | 10000 | - | 1000 |
| BLM18EG/KG_TN | 1.85 | 1.05 | 0.85 max. | - | 4000 | - | 10000 | - | 1000 |
| BLM18EG/KG_SN | | | 1.1 max. | | | | | | |
| BLM18S | 1.85 | 1.05 | 0.90 max. | - | 10000 | - | 30000 | - | 1000 |
| BLM18T | 1.85 | 1.05 | 0.90 max. | - | 10000 | - | - | - | 1000 |
| BLM21 | 2.25 | 1.45 | 1.1 max. | - | 4000 | - | 10000 | - | 1000 |
| BLM31 | 3.5 | 1.9 | 1.3 | 0.2 | - | 3000 | - | 10000 | 1000 |
| BLM21BD222SN1/272SN1 | 2.25 | 1.45 | 1.3 | 0.2 | - | 3000 | - | 10000 | 1000 |
| BLA2A | 2.2 | 1.2 | 0.8 max. | - | 10000 | - | 50000 | - | 1000 |
| BLA31 | 3.4 | 1.8 | 1.1 max. | - | 4000 | - | 10000 | - | 1000 |
| NFM18C/ NFM18PC (Except 105R/225B1A)/ NFM18PS | 1.85 | 1.05 | 0.9 max. | - | 4000 | - | - | - | 500 |
| NFM18PC105R/225B1A | | | 1.1 max. | | | | | | |
| NFL18SP | 1.85 | 1.05 | 0.9 max. | - | 4000 | - | - | - | 1000 |
| NFL18ST | | | 1.1 max. | | | | | | |
| NFL21SP | 2.3 | 1.55 | 1.1 max. | - | 4000 | - | - | - | 500 |
| NFM21 | 2.3 | 1.55 | 1.1 max. | - | 4000 | - | - | - | 500 |
| NFM3DC/3DP | 3.4 | 1.4 | 0.85 | 0.2 | - | 4000 | - | - | 500 |
| NFM31P | 3.5 | 1.9 | 1.5 | 0.25 | - | 3000 | - | - | 500 |
| NFA18S | 1.8 | 1.0 | 0.7 | 0.25 | - | 4000 | - | - | 1000 |
| NFA21SL_45 | 2.30 | 1.55 | 0.7 | 0.25 | - | 4000 | - | - | 1000 |
| NFA21SL_48 | 2.25 | 1.45 | 1.05 | 0.25 | - | 4000 | - | - | 1000 |
| NFA31G/31C | 3.5 | 2.0 | 1.1 max. | - | 4000 | - | - | - | 100 |
| NFE31P | 3.6 | 1.8 | 1.85 | 0.2 | - | 2000 | - | 8000 | 500 |
| NFR21G | 2.3 | 1.55 | 0.7 | 0.25 | - | 4000 | - | - | 500 |
| NFW31S | 3.6 | 1.9 | 2.0 | 0.2 | - | 2000 | - | 7500 | - |
| DLM11G | 1.45 | 1.2 | 0.8 max. | - | 10000 | - | - | - | 1000 |
| DLM2HG | 2.75 | 2.25 | 1.3 | 0.25 | - | 3000 | - | - | 1000 |
| DLP0NS | 0.95 | 0.75 | 0.55 | 0.25 | - | 5000 | - | - | 500 |
| DLP11S | 1.4 | 1.2 | 0.98 | 0.25 | - | 3000 | - | - | 500 |
| DLP2AD | 2.2 | 1.2 | 0.98 | 0.25 | - | 3000 | - | - | 500 |
| DLP31D/31S | 3.5 | 1.9 | 1.3 | 0.25 | - | 3000 | - | - | 500 |
| DLW21S | 2.25 | 1.45 | 1.4 | 0.3 | - | 2000 | - | - | 500 |
| DLW21H | 2.3 | 1.55 | 1.1 | 0.25 | - | 3000 | - | - | 500 |
| DLW31S | 3.6 | 2.0 | 2.1 | 0.3 | - | 2000 | - | - | 500 |

• Please contact us for BLM15/18 in bulk case.

Continued on the following page.

Chip EMIFIL® Packaging

Continued from the preceding page.

Minimum Quantity and Dimensions of 12mm Width Embossed Tape

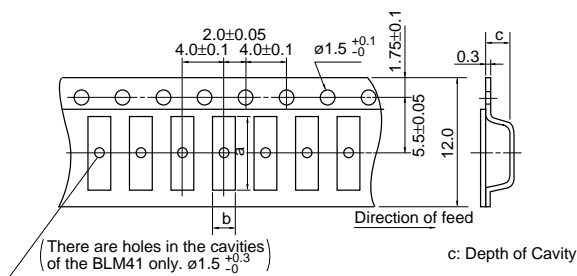

| Part Number | Cavity Size | | | Minimum Qty. (pcs.) | | |
|--------------|-------------|-----|------|---------------------|-------------|------|
| | a | b | c | ø180mm reel | ø330mm reel | Bulk |
| BLM41 | 4.8 | 1.9 | 1.75 | 2500 | 8000 | 1000 |
| NFM41 | 4.8 | 1.8 | 1.1 | 4000 | - | 500 |
| NFE61 | 7.2 | 1.9 | 1.75 | 2500 | 8000 | 500 |

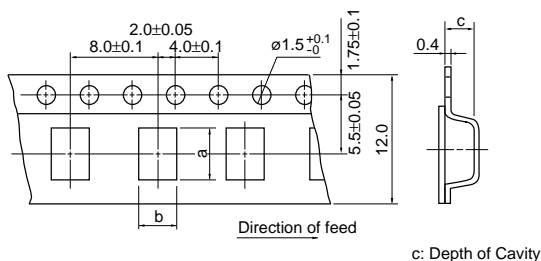

| Part Number | Cavity Size | | | Minimum Qty. (pcs.) | | |
|---------------|-------------|-----|-----|---------------------|-------------|------|
| | a | b | c | ø180mm reel | ø330mm reel | Bulk |
| DLW5AH | 5.4 | 4.1 | 4.4 | 400 | 1500 | 100 |
| DLW5BS | 5.5 | 5.4 | 4.7 | 400 | 1500 | 100 |
| DLW5BT | 5.5 | 5.4 | 2.7 | 700 | 2500 | 100 |

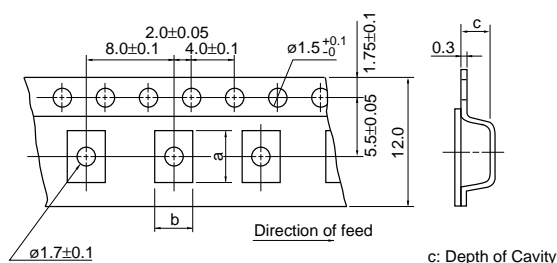

| Part Number | Cavity Size | | | Minimum Qty. (pcs.) | | |
|---------------|-------------|-----|-----|---------------------|-------------|------|
| | a | b | c | ø180mm reel | ø330mm reel | Bulk |
| NFM55P | 6.0 | 5.3 | 2.5 | 500 | - | 100 |

(in mm)

Minimum Quantity and Dimensions of 24mm Width Embossed Tape

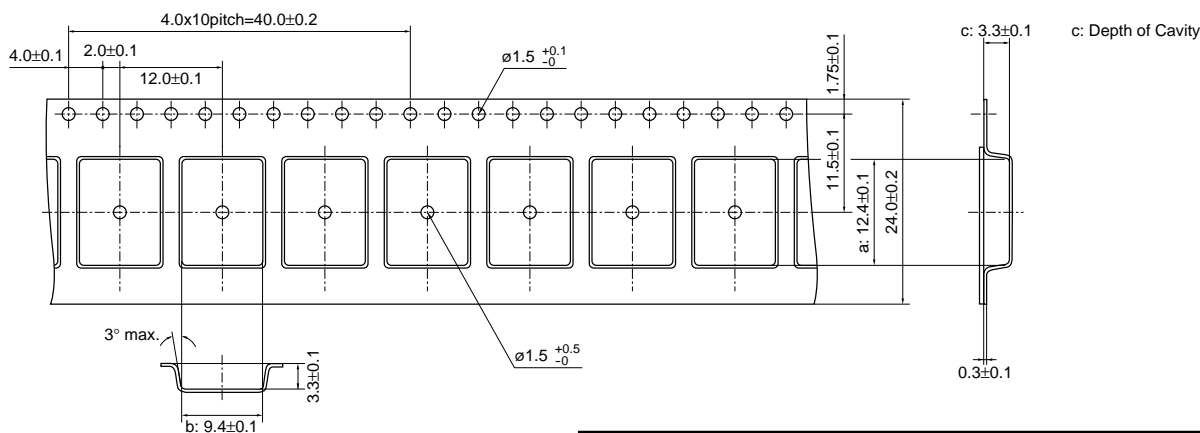

| Part Number | Cavity Size | | | Minimum Qty. (pcs.) | | |
|-------------------|-------------|-----|-----|---------------------|-------------|------|
| | a | b | c | ø180mm reel | ø330mm reel | Bulk |
| BNX022/023 | 12.4 | 9.4 | 3.3 | 400 | 1500 | 100 |

(in mm)

Ferrite Beads Inductors Packaging

Minimum Quantity (Pcs.)

| Series | Bulk | Ammo Pack | ø320mm Paper reel |
|--------|------|-----------|-------------------|
| BL01RN | 500 | 1000 | 2000 |
| BL02RN | 500 | 1500 | — |
| BL03RN | 1000 | 2000 | — |

Taping Dimensions

BL01RN_J

BL01RN_A

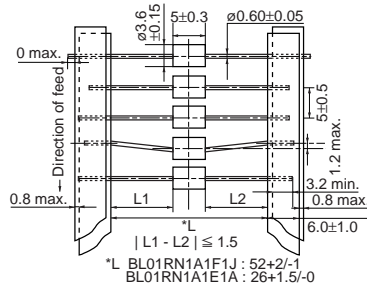

BL02RN1R2□1A

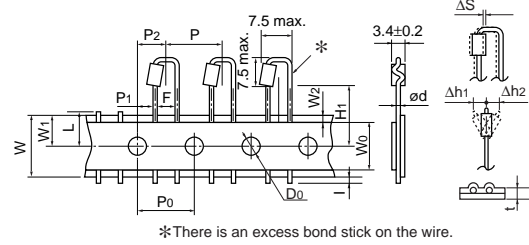

BL02RN1R3N1A

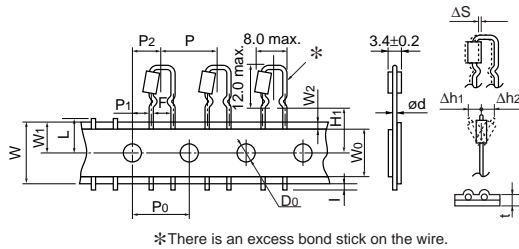

BL02RN2R1□1A

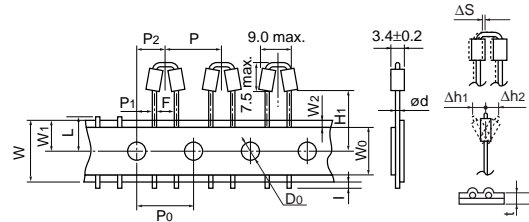

BL02RN2R3N1A

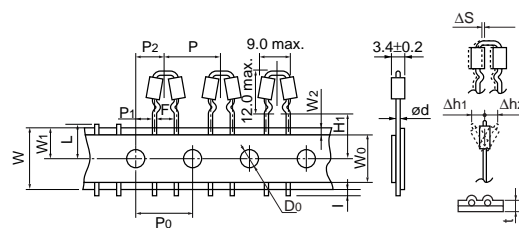

BL03RN2R1□1A

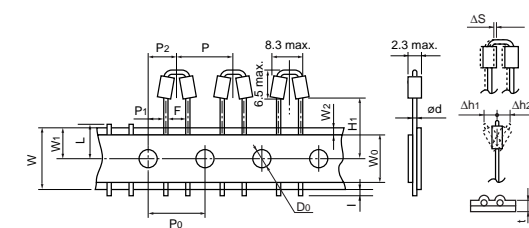

| Description | Symbol | Dimension (mm) | Remarks | |
|--|----------|-------------------------------------|---|---------------------|
| Pitch of component | P | 12.7 | Product inclination ΔS determines tolerance | |
| Pitch of sprocket hole | P0 | 12.7±0.2 | | |
| Lead spacing | F | 5.0 ^{+0.8} _{-0.2} | | |
| Hole center to lead | P1 | 3.85±0.7 | | |
| Hole center to component center | P2 | 6.35±1.3 | Tape deviation in feeding direction | |
| Offset of bead | ΔS | ±1.0 | Include the offset caused by lead bend | |
| Carrier tape width | W | 18.0±0.5 | | |
| Position of sprocket hole | W1 | 9.0 ⁺⁰ _{-0.5} | Tape with deviation | |
| Lead length between sprocket hole and forming position | H1 | Lead Length Number : N | 16.5±0.5 | BL02, BL03 |
| | | Lead Length Number : Q | 20.0±0.5 | BL02RN1R2/2R1, BL03 |
| | | Lead Length Number : P | 18.5±0.5 | BL02, BL03 |
| Protruding length | l | +0.5 to -1.0 | | |
| Diameter of sprocket hole | D0 | ø4.0±0.1 | | |
| Lead Diameter | ød | ø0.60 | | |
| Total tape thickness | t | 0.7±0.2 | Including bonding tape thickness | |
| Deviation across tape, Deviation across tape rear | Δh1, Δh2 | 1.0 max. | | |
| Cutting position of failure | L | 11.0 ⁺⁰ _{-1.0} | | |
| Hold down tape width | W0 | 12.0±0.5 | | |
| Hold down tape position | W2 | 1.5±1.5 | | |

(in mm)

Disc Type EMIFIL[®] and EMIGUARD[®] Packaging

Minimum Quantity

| Part Number | Minimum Order Quantity (order in sets only) (Pcs.) | | |
|-------------------|--|-------------------|--------------------------------|
| | Ammo Pack | ø320mm Paper reel | Bulk (Bag) |
| VFR3V Series | 2000 | — | 250 |
| DS□6/VFS6V Series | 2000 | — | 250 Q55/T51 500 Q54/Q56/T41 |
| DSN9/9H Series | 2000 | — | 250 Q55 500 Q54/Q56 |
| DST9 Series | 1000 | — | 200 Q55 250 Q50/Q52 |
| DSS9 Series | — | 800 | 200 Q55 500 Q54/Q56 |
| VFS9V Series | — | 800 | 200 |

Lead Type Code

| Lead Type code | | Lead length (H) |
|----------------|--------------|-----------------|
| Straight Type | Incrimp Type | |
| Q91 | - | 20.0±1.0mm |
| Q92 | U21 | 16.5±1.0mm |
| Q93 | U31 | 18.5±1.0mm |

Taping Dimensions

DSN6_Q91/Q92/Q93

DSN9_Q91/Q92/Q93

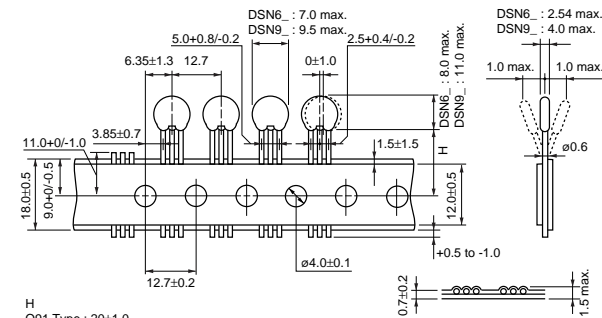

H
Q91 Type : 20±1.0
Q92 Type : 16.5±1.0
Q93 Type : 18.5±1.0

DSS6_Q91/Q92/Q93

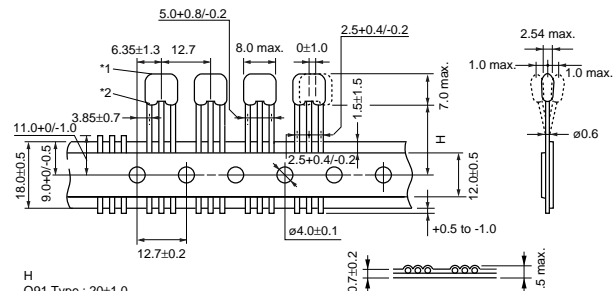

H
Q91 Type : 20±1.0
Q92 Type : 16.5±1.0
Q93 Type : 18.5±1.0
*1 Bottom of dielectric may be exposed.
*2 If a hole is on the top of the ferrite bead, the bead should not be exposed.

DST9_Q92/Q93

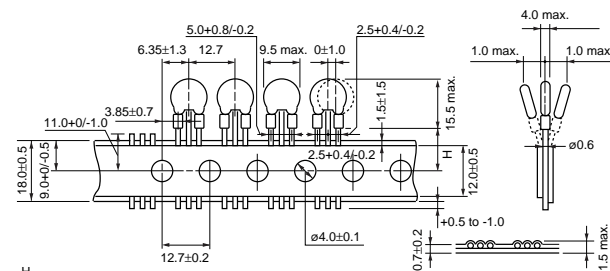

H
Q92 Type : 16.5±1.0
Q93 Type : 18.5±1.0

DSS6_U21/U31

VFS6V_U31

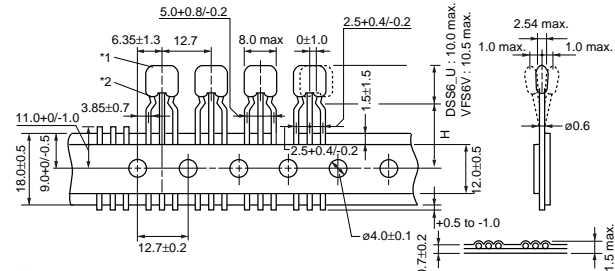

H
U21 Type : 16.5±1.0
U31 Type : 18.5±1.0
*1 Bottom of dielectric may be exposed.
*2 If a hole is on the top of the ferrite bead, the bead should not be exposed.

DSS9_Q91/Q92/Q93

VFS9V_Q91/Q92/Q93

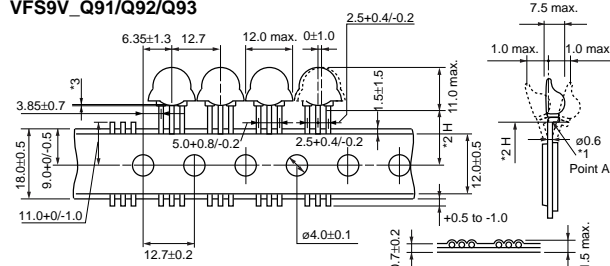

H
Q91 Type : 20±1.0
Q92 Type : 16.5±1.0
Q93 Type : 18.5±1.0
*1 Coating extending on leads does not exceed the start of bend. (Point A)
Exposed electrodes are covered with solder.
*2 H: to be measured from the forming point A.
*3 The deviation between two ferrite beads should be less than 1.2mm.

VFR3V_U31

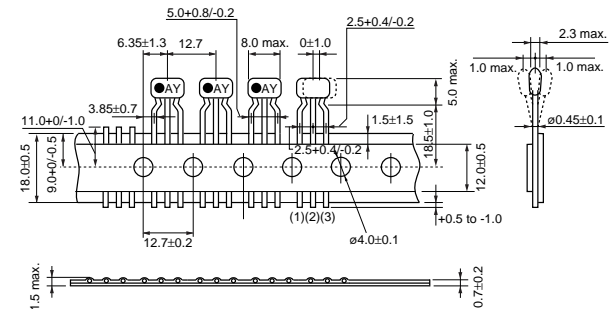

(in mm)

Chip EMI Suppression Filter Design Kits



●EKEMBL03D (Chip Ferrite Beads 01005 Size / 0201 Size)

| No. | Part Number | Quantity (pcs.) | Impedance typ. (at 100MHz, 20 degrees C) | Rated Current (mA) | DC Resistance (Ω) max. |
|-----|---------------|-----------------|--|--------------------|------------------------|
| 1 | BLM02AG100SN1 | 10 | 10Ω (Typ.) | 500 | 0.1 |
| 2 | BLM02AG700SN1 | 10 | 70Ω±25% | 250 | 0.5 |
| 3 | BLM02AG121SN1 | 10 | 120Ω±25% | 200 | 0.8 |
| 4 | BLM03AG100SN1 | 10 | 10Ω (Typ.) | 500 | 0.1 |
| 5 | BLM03AG700SN1 | 10 | 70Ω (Typ.) | 200 | 0.4 |
| 6 | BLM03AG800SN1 | 10 | 80Ω±25% | 200 | 0.4 |
| 7 | BLM03AG121SN1 | 10 | 120Ω±25% | 200 | 0.5 |
| 8 | BLM03AG241SN1 | 10 | 240Ω±25% | 200 | 0.8 |
| 9 | BLM03AG601SN1 | 10 | 600Ω±25% | 100 | 1.5 |
| 10 | BLM03AG102SN1 | 10 | 1000Ω±25% | 100 | 2.5 |
| 11 | BLM03BB100SN1 | 10 | 10Ω±25% | 300 | 0.4 |
| 12 | BLM03BB220SN1 | 10 | 22Ω±25% | 200 | 0.5 |
| 13 | BLM03BB470SN1 | 10 | 47Ω±25% | 200 | 0.7 |
| 14 | BLM03BB750SN1 | 10 | 75Ω±25% | 200 | 1.0 |
| 15 | BLM03BB121SN1 | 10 | 120Ω±25% | 100 | 1.5 |
| 16 | BLM03BD750SN1 | 10 | 75Ω±25% | 300 | 0.4 |
| 17 | BLM03BD121SN1 | 10 | 120Ω±25% | 250 | 0.5 |
| 18 | BLM03BD241SN1 | 10 | 240Ω±25% | 200 | 0.8 |
| 19 | BLM03PG220SN1 | 10 | 22Ω±25% | 900 | 0.065 |
| 20 | BLM03PG330SN1 | 10 | 33Ω±25% | 750 | 0.090 |

●EKEMBL15J (Chip Ferrite Beads 0402 Size)

| No. | Part Number | Quantity (pcs.) | Impedance typ. (at 100MHz, 20 degrees C) | Rated Current (mA) | DC Resistance (Ω) max. |
|-----|---------------|-----------------|--|--------------------|------------------------|
| 1 | BLM15AG100SN1 | 10 | 10Ω (Typ.) | 1000 | 0.05 |
| 2 | BLM15AG700SN1 | 10 | 70Ω (Typ.) | 500 | 0.15 |
| 3 | BLM15AG121SN1 | 10 | 120Ω±25% | 500 | 0.25 |
| 4 | BLM15AG221SN1 | 10 | 220Ω±25% | 300 | 0.35 |
| 5 | BLM15AG601SN1 | 10 | 600Ω±25% | 300 | 0.60 |
| 6 | BLM15AG102SN1 | 10 | 1000Ω±25% | 200 | 1.00 |
| 7 | BLM15BA050SN1 | 10 | 5Ω±25% | 300 | 0.10 |
| 8 | BLM15BA100SN1 | 10 | 10Ω±25% | 300 | 0.20 |
| 9 | BLM15BA220SN1 | 10 | 22Ω±25% | 300 | 0.30 |
| 10 | BLM15BA330SN1 | 10 | 33Ω±25% | 300 | 0.40 |
| 11 | BLM15BA470SN1 | 10 | 47Ω±25% | 200 | 0.60 |
| 12 | BLM15BA750SN1 | 10 | 75Ω±25% | 200 | 0.80 |
| 13 | BLM15BB050SN1 | 10 | 5Ω±25% | 500 | 0.08 |
| 14 | BLM15BB100SN1 | 10 | 10Ω±25% | 300 | 0.10 |
| 15 | BLM15BB220SN1 | 10 | 22Ω±25% | 300 | 0.20 |

Continued on the following page.

Chip EMI Suppression Filter Design Kits

Continued from the preceding page.

| No. | Part Number | Quantity (pcs.) | Impedance typ. (at 100MHz, 20 degrees C) | Rated Current (mA) | DC Resistance (Ω) max. |
|-----|---------------|-----------------|--|--------------------|------------------------|
| 16 | BLM15BB470SN1 | 10 | 47Ω±25% | 300 | 0.35 |
| 17 | BLM15BB750SN1 | 10 | 75Ω±25% | 300 | 0.40 |
| 18 | BLM15BB121SN1 | 10 | 120Ω±25% | 300 | 0.55 |
| 19 | BLM15BB221SN1 | 10 | 220Ω±25% | 200 | 0.80 |
| 20 | BLM15BD750SN1 | 10 | 75Ω±25% | 300 | 0.20 |
| 21 | BLM15BD121SN1 | 10 | 120Ω±25% | 300 | 0.30 |
| 22 | BLM15BD221SN1 | 10 | 220Ω±25% | 300 | 0.40 |
| 23 | BLM15BD471SN1 | 10 | 470Ω±25% | 200 | 0.60 |
| 24 | BLM15BD601SN1 | 10 | 600Ω±25% | 200 | 0.65 |
| 25 | BLM15BD102SN1 | 10 | 1000Ω±25% | 200 | 0.90 |
| 26 | BLM15BD182SN1 | 10 | 1800Ω±25% | 100 | 1.40 |
| 27 | BLM15HD601SN1 | 10 | 600Ω±25% | 300 | 0.85 |
| 28 | BLM15HD102SN1 | 10 | 1000Ω±25% | 250 | 1.25 |
| 29 | BLM15HD182SN1 | 10 | 1800Ω±25% | 200 | 2.20 |
| 30 | BLM15HG601SN1 | 10 | 600Ω±25% | 300 | 0.70 |
| 31 | BLM15HG102SN1 | 10 | 1000Ω±25% | 250 | 1.10 |
| 32 | BLM15HB121SN1 | 10 | 120Ω±25% | 300 | 0.70 |
| 33 | BLM15HB221SN1 | 10 | 220Ω±25% | 250 | 1.00 |
| 34 | BLM15EG121SN1 | 10 | 120Ω±25% | 1500 | 0.095 |
| 35 | BLM15EG221SN1 | 10 | 220Ω±25% | 700 | 0.28 |
| 36 | BLM15GG221SN1 | 10 | 220Ω±25% | 300 | 0.70 |
| 37 | BLM15GG471SN1 | 10 | 470Ω±25% | 200 | 1.30 |
| 38 | BLM15GA750SN1 | 10 | 75Ω±25% | 200 | 1.30 |
| 39 | BLM15PG100SN1 | 10 | 10Ω (Typ.) | 1000 | 0.05 |
| 40 | BLM15PD300SN1 | 10 | 30Ω±25% | 2200 | 0.035 |
| 41 | BLM15PD600SN1 | 10 | 60Ω±25% | 1700 | 0.06 |
| 42 | BLM15PD800SN1 | 10 | 80Ω±25% | 1500 | 0.07 |
| 43 | BLM15PD121SN1 | 10 | 120Ω±25% | 1300 | 0.09 |

●EKEMBL18G (Chip Ferrite Beads 0603 Size)

| No. | Part Number | Quantity (pcs.) | Impedance typ. (at 100MHz, 20 degrees C) | Rated Current (mA) | DC Resistance (Ω) max. |
|-----|---------------|-----------------|--|--------------------|------------------------|
| 1 | BLM18AG121SN1 | 10 | 120Ω±25% | 500 | 0.18 |
| 2 | BLM18AG151SN1 | 10 | 150Ω±25% | 500 | 0.25 |
| 3 | BLM18AG221SN1 | 10 | 220Ω±25% | 500 | 0.25 |
| 4 | BLM18AG331SN1 | 10 | 330Ω±25% | 500 | 0.30 |
| 5 | BLM18AG471SN1 | 10 | 470Ω±25% | 500 | 0.35 |
| 6 | BLM18AG601SN1 | 10 | 600Ω±25% | 500 | 0.38 |
| 7 | BLM18AG102SN1 | 10 | 1000Ω±25% | 400 | 0.50 |
| 8 | BLM18BA050SN1 | 10 | 5Ω±25% | 500 | 0.20 |
| 9 | BLM18BA100SN1 | 10 | 10Ω±25% | 500 | 0.25 |
| 10 | BLM18BA470SN1 | 10 | 47Ω±25% | 300 | 0.55 |
| 11 | BLM18BA750SN1 | 10 | 75Ω±25% | 300 | 0.70 |
| 12 | BLM18BA121SN1 | 10 | 120Ω±25% | 200 | 0.90 |
| 13 | BLM18BB050SN1 | 10 | 5Ω±25% | 700 | 0.05 |
| 14 | BLM18BB100SN1 | 10 | 10Ω±25% | 700 | 0.10 |
| 15 | BLM18BB220SN1 | 10 | 22Ω±25% | 600 | 0.20 |
| 16 | BLM18BB470SN1 | 10 | 47Ω±25% | 550 | 0.25 |
| 17 | BLM18BB600SN1 | 10 | 60Ω±25% | 550 | 0.25 |
| 18 | BLM18BB750SN1 | 10 | 75Ω±25% | 500 | 0.30 |
| 19 | BLM18BB121SN1 | 10 | 120Ω±25% | 500 | 0.30 |
| 20 | BLM18BB151SN1 | 10 | 150Ω±25% | 450 | 0.37 |

Continued on the following page. 

Chip EMI Suppression Filter Design Kits

Continued from the preceding page.

| No. | Part Number | Quantity (pcs.) | Impedance typ. (at 100MHz, 20 degrees C) | Rated Current (mA) | DC Resistance (Ω) max. |
|-----|---------------|-----------------|--|--------------------|------------------------|
| 21 | BLM18BB221SN1 | 10 | 220Ω±25% | 450 | 0.45 |
| 22 | BLM18BB331SN1 | 10 | 330Ω±25% | 400 | 0.58 |
| 23 | BLM18BB471SN1 | 10 | 470Ω±25% | 300 | 0.85 |
| 24 | BLM18BD470SN1 | 10 | 47Ω±25% | 200 | 0.30 |
| 25 | BLM18BD121SN1 | 10 | 120Ω±25% | 200 | 0.40 |
| 26 | BLM18BD151SN1 | 10 | 150Ω±25% | 200 | 0.40 |
| 27 | BLM18BD221SN1 | 10 | 220Ω±25% | 200 | 0.45 |
| 28 | BLM18BD331SN1 | 10 | 330Ω±25% | 200 | 0.50 |
| 29 | BLM18BD421SN1 | 10 | 420Ω±25% | 200 | 0.55 |
| 30 | BLM18BD471SN1 | 10 | 470Ω±25% | 200 | 0.55 |
| 31 | BLM18BD601SN1 | 10 | 600Ω±25% | 200 | 0.65 |
| 32 | BLM18BD102SN1 | 10 | 1000Ω±25% | 100 | 0.85 |
| 33 | BLM18BD152SN1 | 10 | 1500Ω±25% | 50 | 1.20 |
| 34 | BLM18BD182SN1 | 10 | 1800Ω±25% | 50 | 1.50 |
| 35 | BLM18BD222SN1 | 10 | 2200Ω±25% | 50 | 1.50 |
| 36 | BLM18BD252SN1 | 10 | 2500Ω±25% | 50 | 1.50 |
| 37 | BLM18PG300SN1 | 10 | 30Ω (Typ.) | 1000 | 0.05 |
| 38 | BLM18PG330SN1 | 10 | 33Ω±25% | 3000 | 0.025 |
| 39 | BLM18PG600SN1 | 10 | 60Ω (Typ.) | 500 | 0.10 |
| 40 | BLM18PG121SN1 | 10 | 120Ω±25% | 2000 | 0.05 |
| 41 | BLM18PG181SN1 | 10 | 180Ω±25% | 1500 | 0.09 |
| 42 | BLM18PG221SN1 | 10 | 220Ω±25% | 1400 | 0.10 |
| 43 | BLM18PG331SN1 | 10 | 330Ω±25% | 1200 | 0.15 |
| 44 | BLM18PG471SN1 | 10 | 470Ω±25% | 1000 | 0.20 |
| 45 | BLM18KG260TN1 | 10 | 26Ω±25% | 6000 | 0.007 |
| 46 | BLM18KG700TN1 | 10 | 70Ω±25% | 3500 | 0.022 |
| 47 | BLM18KG121TN1 | 10 | 120Ω±25% | 3000 | 0.030 |
| 48 | BLM18KG221SN1 | 10 | 220Ω±25% | 2200 | 0.050 |
| 49 | BLM18KG331SN1 | 10 | 330Ω±25% | 1700 | 0.080 |
| 50 | BLM18KG471SN1 | 10 | 470Ω±25% | 1500 | 0.130 |
| 51 | BLM18KG601SN1 | 10 | 600Ω±25% | 1300 | 0.150 |
| 52 | BLM18SG260TN1 | 10 | 26Ω±25% | 6000 | 0.007 |
| 53 | BLM18SG700TN1 | 10 | 70Ω±25% | 4000 | 0.020 |
| 54 | BLM18SG121TN1 | 10 | 120Ω±25% | 3000 | 0.025 |
| 55 | BLM18SG221TN1 | 10 | 220Ω±25% | 2500 | 0.040 |
| 56 | BLM18SG331TN1 | 10 | 330Ω±25% | 1500 | 0.070 |
| 57 | BLM18RK121SN1 | 10 | 120Ω±25% | 200 | 0.25 |
| 58 | BLM18RK471SN1 | 10 | 470Ω±25% | 200 | 0.5 |
| 59 | BLM18RK601SN1 | 10 | 600Ω±25% | 200 | 0.6 |
| 60 | BLM18RK102SN1 | 10 | 1000Ω±25% | 200 | 0.8 |

●EKEMBL8GA (Chip Ferrite Beads 0603 Size / for High Frequency Type)

| No. | Part Number | Quantity (pcs.) | Impedance (at 100MHz, 20 degrees C) | Impedance (at 1GHz, 20 degrees C) | Rated Current (mA) | DC Resistance (Ω) max. |
|-----|---------------|-----------------|-------------------------------------|-----------------------------------|--------------------|------------------------|
| 1 | BLM18HG471SN1 | 10 | 470Ω±25% | 600Ω (Typ.) | 200 | 0.85 |
| 2 | BLM18HG601SN1 | 10 | 600Ω±25% | 700Ω (Typ.) | 200 | 1.00 |
| 3 | BLM18HG102SN1 | 10 | 1000Ω±25% | 1000Ω (Typ.) | 100 | 1.60 |
| 4 | BLM18HB121SN1 | 10 | 120Ω±25% | 500Ω±40% | 200 | 0.50 |
| 5 | BLM18HB221SN1 | 10 | 220Ω±25% | 1100Ω±40% | 100 | 0.80 |
| 6 | BLM18HB331SN1 | 10 | 330Ω±25% | 1600Ω±40% | 50 | 1.20 |
| 7 | BLM18HD471SN1 | 10 | 470Ω±25% | 1000Ω (Typ.) | 100 | 1.20 |
| 8 | BLM18HD601SN1 | 10 | 600Ω±25% | 1200Ω (Typ.) | 100 | 1.50 |

Continued on the following page. 

Chip EMI Suppression Filter Design Kits

Continued from the preceding page.

| No. | Part Number | Quantity (pcs.) | Impedance (at 100MHz, 20 degrees C) | Impedance (at 1GHz, 20 degrees C) | Rated Current (mA) | DC Resistance (Ω) max. |
|-----|---------------|-----------------|-------------------------------------|-----------------------------------|--------------------|------------------------|
| 9 | BLM18HD102SN1 | 10 | 1000Ω±25% | 1700Ω (Typ.) | 50 | 1.80 |
| 10 | BLM18HE601SN1 | 10 | 600Ω±25% | 600Ω (Typ.) | 800 | 0.25 |
| 11 | BLM18HE102SN1 | 10 | 1000Ω±25% | 1000Ω (Typ.) | 600 | 0.35 |
| 12 | BLM18HE152SN1 | 10 | 1500Ω±25% | 1500Ω (Typ.) | 500 | 0.50 |
| 13 | BLM18HK331SN1 | 10 | 330Ω±25% | 400Ω (Typ.) | 200 | 0.50 |
| 14 | BLM18HK471SN1 | 10 | 470Ω±25% | 600Ω (Typ.) | 200 | 0.70 |
| 15 | BLM18HK601SN1 | 10 | 600Ω±25% | 700Ω (Typ.) | 100 | 0.90 |
| 16 | BLM18HK102SN1 | 10 | 1000Ω±25% | 1200Ω (Typ.) | 50 | 1.50 |
| 17 | BLM18EG101TN1 | 10 | 100Ω±25% | 140Ω (Typ.) | 2000 | 0.045 |
| 18 | BLM18EG121SN1 | 10 | 120Ω±25% | 145Ω (Typ.) | 2000 | 0.04 |
| 19 | BLM18EG221TN1 | 10 | 220Ω±25% | 300Ω (Typ.) | 1000 | 0.15 |
| 20 | BLM18EG221SN1 | 10 | 220Ω±25% | 260Ω (Typ.) | 2000 | 0.05 |
| 21 | BLM18EG331TN1 | 10 | 330Ω±25% | 450Ω (Typ.) | 500 | 0.21 |
| 22 | BLM18EG391TN1 | 10 | 390Ω±25% | 520Ω (Typ.) | 500 | 0.30 |
| 23 | BLM18EG471SN1 | 10 | 470Ω±25% | 550Ω (Typ.) | 500 | 0.21 |
| 24 | BLM18EG601SN1 | 10 | 600Ω±25% | 700Ω (Typ.) | 500 | 0.35 |
| 25 | BLM18GG471SN1 | 10 | 470Ω±25% | 1800Ω±30% | 200 | 1.30 |

●EKEMBL21D (Chip Ferrite Beads 0805 Size / for Large-current P Type)

| No. | Part Number | Quantity (pcs.) | Impedance typ. (at 100MHz, 20 degrees C) | Rated Current (mA) | DC Resistance (Ω) max. |
|-----|---------------|-----------------|--|--------------------|------------------------|
| 1 | BLM21AG121SN1 | 10 | 120Ω±25% | 200 | 0.15 |
| 2 | BLM21AG151SN1 | 10 | 150Ω±25% | 200 | 0.15 |
| 3 | BLM21AG221SN1 | 10 | 220Ω±25% | 200 | 0.20 |
| 4 | BLM21AG331SN1 | 10 | 330Ω±25% | 200 | 0.25 |
| 5 | BLM21AG471SN1 | 10 | 470Ω±25% | 200 | 0.25 |
| 6 | BLM21AG601SN1 | 10 | 600Ω±25% | 200 | 0.30 |
| 7 | BLM21AG102SN1 | 10 | 1000Ω±25% | 200 | 0.45 |
| 8 | BLM21BB050SN1 | 10 | 5Ω±25% | 500 | 0.07 |
| 9 | BLM21BB600SN1 | 10 | 60Ω±25% | 200 | 0.20 |
| 10 | BLM21BB750SN1 | 10 | 75Ω±25% | 200 | 0.25 |
| 11 | BLM21BB121SN1 | 10 | 120Ω±25% | 200 | 0.25 |
| 12 | BLM21BB221SN1 | 10 | 220Ω±25% | 200 | 0.35 |
| 13 | BLM21BB331SN1 | 10 | 330Ω±25% | 200 | 0.40 |
| 14 | BLM21BB471SN1 | 10 | 470Ω±25% | 200 | 0.45 |
| 15 | BLM21BD121SN1 | 10 | 120Ω±25% | 200 | 0.25 |
| 16 | BLM21BD221SN1 | 10 | 220Ω±25% | 200 | 0.25 |
| 17 | BLM21BD421SN1 | 10 | 420Ω±25% | 200 | 0.30 |
| 18 | BLM21BD471SN1 | 10 | 470Ω±25% | 200 | 0.35 |
| 19 | BLM21BD601SN1 | 10 | 600Ω±25% | 200 | 0.35 |
| 20 | BLM21BD102SN1 | 10 | 1000Ω±25% | 200 | 0.40 |
| 21 | BLM21BD152SN1 | 10 | 1500Ω±25% | 200 | 0.45 |
| 22 | BLM21BD182SN1 | 10 | 1800Ω±25% | 200 | 0.50 |
| 23 | BLM21BD222SN1 | 10 | 2250Ω (Typ.) | 200 | 0.60 |
| 24 | BLM21BD222TN1 | 10 | 2200Ω±25% | 200 | 0.60 |
| 25 | BLM21BD272SN1 | 10 | 2700Ω±25% | 200 | 0.80 |
| 26 | BLM21PG220SN1 | 10 | 22Ω±25% | 6000 | 0.01 |
| 27 | BLM21PG300SN1 | 10 | 30Ω (Typ.) | 3000 | 0.015 |
| 28 | BLM21PG600SN1 | 10 | 60Ω±25% | 3000 | 0.025 |
| 29 | BLM21PG221SN1 | 10 | 220Ω±25% | 2000 | 0.050 |
| 30 | BLM21PG331SN1 | 10 | 330Ω±25% | 1500 | 0.09 |
| 31 | BLM31PG330SN1 | 10 | 33Ω±25% | 6000 | 0.01 |

Continued on the following page. ↗

Chip EMI Suppression Filter Design Kits

Continued from the preceding page.

| No. | Part Number | Quantity (pcs.) | Impedance typ. (at 100MHz, 20 degrees C) | Rated Current (mA) | DC Resistance (Ω) max. |
|-----|---------------|-----------------|--|--------------------|------------------------|
| 32 | BLM31PG500SN1 | 10 | 50Ω (Typ.) | 3000 | 0.025 |
| 33 | BLM31PG121SN1 | 10 | 120Ω±25% | 3000 | 0.025 |
| 34 | BLM31PG391SN1 | 10 | 390Ω (Typ.) | 2000 | 0.05 |
| 35 | BLM31PG601SN1 | 10 | 600Ω (Typ.) | 1500 | 0.09 |
| 36 | BLM41PG600SN1 | 10 | 60Ω (Typ.) | 6000 | 0.01 |
| 37 | BLM41PG750SN1 | 10 | 75Ω (Typ.) | 3000 | 0.025 |
| 38 | BLM41PG181SN1 | 10 | 180Ω (Typ.) | 3000 | 0.025 |
| 39 | BLM41PG471SN1 | 10 | 470Ω (Typ.) | 2000 | 0.05 |
| 40 | BLM41PG102SN1 | 10 | 1000Ω (Typ.) | 1500 | 0.09 |

●EKEMNFMCB (Chip EMIFIL® Capacitor Type for Signal Lines)

| No. | Part Number | Quantity (pcs.) | Capacitance | Rated Voltage (Vdc) | Rated Current (mA) | Insulation Resistance (MΩ min.) |
|-----|----------------|-----------------|-------------|---------------------|--------------------|---------------------------------|
| 1 | NFM18CC220U1C3 | 10 | 22pF±20% | 16 | 400 | 1000 |
| 2 | NFM18CC470U1C3 | 10 | 47pF±20% | 16 | 400 | 1000 |
| 3 | NFM18CC101R1C3 | 10 | 100pF±20% | 16 | 500 | 1000 |
| 4 | NFM18CC221R1C3 | 10 | 220pF±20% | 16 | 500 | 1000 |
| 5 | NFM18CC471R1C3 | 10 | 470pF±20% | 16 | 500 | 1000 |
| 6 | NFM18CC102R1C3 | 10 | 1000pF±20% | 16 | 600 | 1000 |
| 7 | NFM18CC222R1C3 | 10 | 2200pF±20% | 16 | 700 | 1000 |
| 8 | NFM18CC223R1C3 | 10 | 22000pF±20% | 16 | 1000 | 1000 |
| 9 | NFM21CC220U1H3 | 10 | 22pF±20% | 50 | 700 | 1000 |
| 10 | NFM21CC470U1H3 | 10 | 47pF±20% | 50 | 700 | 1000 |
| 11 | NFM21CC101U1H3 | 10 | 100pF±20% | 50 | 700 | 1000 |
| 12 | NFM21CC221R1H3 | 10 | 220pF±20% | 50 | 700 | 1000 |
| 13 | NFM21CC471R1H3 | 10 | 470pF±20% | 50 | 1000 | 1000 |
| 14 | NFM21CC102R1H3 | 10 | 1000pF±20% | 50 | 1000 | 1000 |
| 15 | NFM21CC222R1H3 | 10 | 2200pF±20% | 50 | 1000 | 1000 |
| 16 | NFM21CC223R1H3 | 10 | 22000pF±20% | 50 | 2000 | 1000 |

●EKEMFA31D (Chip EMIFIL® Capacitor Array Type/ RC Combined Array Type)

| No. | Part Number | Quantity (pcs.) | Capacitance | Rated Voltage (Vdc) | Rated Current (mA) | Insulation Resistance (MΩ min.) |
|-----|----------------|-----------------|-------------|---------------------|--------------------|---------------------------------|
| 1 | NFA31CC220S1E4 | 10 | 22pF±20% | 25 | 200 | 1000 |
| 2 | NFA31CC470S1E4 | 10 | 47pF±20% | 25 | 200 | 1000 |
| 3 | NFA31CC101S1E4 | 10 | 100pF±20% | 25 | 200 | 1000 |
| 4 | NFA31CC221S1E4 | 10 | 220pF±20% | 25 | 200 | 1000 |
| 5 | NFA31CC471R1E4 | 10 | 470pF±20% | 25 | 200 | 1000 |
| 6 | NFA31CC102R1E4 | 10 | 1000pF±20% | 25 | 200 | 1000 |
| 7 | NFA31CC222R1E4 | 10 | 2200pF±20% | 25 | 200 | 1000 |
| 8 | NFA31CC223R1C4 | 10 | 22000pF±20% | 16 | 200 | 1000 |
| 9 | NFA31GD1006R84 | 10 | 10pF±20% | 6 | 50 | 1000 |
| 10 | NFA31GD1004704 | 10 | 10pF±20% | 6 | 20 | 1000 |
| 11 | NFA31GD1001014 | 10 | 10pF±20% | 6 | 15 | 1000 |
| 12 | NFA31GD4706R84 | 10 | 47pF±20% | 6 | 50 | 1000 |
| 13 | NFA31GD4703304 | 10 | 47pF±20% | 6 | 20 | 1000 |
| 14 | NFA31GD4704704 | 10 | 47pF±20% | 6 | 20 | 1000 |
| 15 | NFA31GD4701014 | 10 | 47pF±20% | 6 | 15 | 1000 |
| 16 | NFA31GD1016R84 | 10 | 100pF±20% | 6 | 50 | 1000 |
| 17 | NFA31GD1014704 | 10 | 100pF±20% | 6 | 20 | 1000 |

Continued on the following page. 

Chip EMI Suppression Filter Design Kits

Continued from the preceding page.

| No. | Part Number | Quantity (pcs.) | Capacitance | Rated Voltage (Vdc) | Rated Current (mA) | Insulation Resistance (MΩ min.) |
|-----|-----------------------|-----------------|-------------|---------------------|--------------------|---------------------------------|
| 18 | NFA31GD1011014 | 10 | 100pF±20% | 6 | 15 | 1000 |

●EKEMFL18E (Chip EMIFIL® LC Combined Type)

| No. | Part Number | Quantity (pcs.) | Cut-off Frequency | Rated Voltage (Vdc) | Rated Current (mA) | Insulation Resistance (MΩ min.) | DC Resistance (Ω) max. |
|-----|-----------------------|-----------------|-------------------|---------------------|--------------------|---------------------------------|------------------------|
| 1 | NFL18ST207X1C3 | 10 | 200MHz | 16 | 150 | 1000 | 3.5 |
| 2 | NFL18ST307X1C3 | 10 | 300MHz | 16 | 200 | 1000 | 1.8 |
| 3 | NFL18ST507X1C3 | 10 | 500MHz | 16 | 200 | 1000 | 1.5 |
| 4 | NFL18SP157X1A3 | 10 | 150MHz | 10 | 100 | 1000 | 3.0 |
| 5 | NFL18SP207X1A3 | 10 | 200MHz | 10 | 100 | 1000 | 3.0 |
| 6 | NFL18SP307X1A3 | 10 | 300MHz | 10 | 100 | 1000 | 3.0 |
| 7 | NFL18SP507X1A3 | 10 | 500MHz | 10 | 100 | 1000 | 2.0 |
| 8 | NFL21SP106X1C3 | 10 | 10MHz | 16 | 100 | 1000 | 8.5 |
| 9 | NFL21SP206X1C7 | 10 | 20MHz | 16 | 100 | 1000 | 8.5 |
| 10 | NFL21SP506X1C3 | 10 | 50MHz | 16 | 150 | 1000 | 3.5 |
| 11 | NFL21SP706X1C3 | 10 | 70MHz | 16 | 150 | 1000 | 3.0 |
| 12 | NFL21SP107X1C3 | 10 | 100MHz | 16 | 200 | 1000 | 2.0 |
| 13 | NFL21SP157X1C3 | 10 | 150MHz | 16 | 200 | 1000 | 2.0 |
| 14 | NFL21SP207X1C3 | 10 | 200MHz | 16 | 250 | 1000 | 1.5 |
| 15 | NFL21SP307X1C3 | 10 | 300MHz | 16 | 300 | 1000 | 1.2 |
| 16 | NFL21SP407X1C3 | 10 | 400MHz | 16 | 300 | 1000 | 1.2 |
| 17 | NFL21SP507X1C3 | 10 | 500MHz | 16 | 300 | 1000 | 1.2 |

| No. | Part Number | Quantity (pcs.) | Cut-off Frequency | Attenuation (dB min.) | | | | | | | | | | Rated Current | Rated Voltage |
|-----|-----------------------|-----------------|-------------------|-----------------------|----------|----------|----------|----------|----------|----------|----------|----------|------|---------------|---------------|
| | | | | 10MHz | 20MHz | 50MHz | 100MHz | 150MHz | 200MHz | 300MHz | 400MHz | 500MHz | 1GHz | | |
| 18 | NFW31SP106X1E4 | 10 | 10MHz | 6dB max. | 5 | 25 | 25 | - | 25 | - | - | 30 | 30 | 200mA | 25V |
| 19 | NFW31SP206X1E4 | 10 | 20MHz | - | 6dB max. | 5 | 25 | - | 25 | - | - | 30 | 30 | 200mA | 25V |
| 20 | NFW31SP506X1E4 | 10 | 50MHz | - | - | 6dB max. | 10 | - | 30 | - | - | 30 | 30 | 200mA | 25V |
| 21 | NFW31SP107X1E4 | 10 | 100MHz | - | - | - | 6dB max. | - | 5 | - | - | 20 | 30 | 200mA | 25V |
| 22 | NFW31SP157X1E4 | 10 | 150MHz | - | - | - | - | 6dB max. | - | 10 | 20 | 30 | 30 | 200mA | 25V |
| 23 | NFW31SP207X1E4 | 10 | 200MHz | - | - | - | - | - | 6dB max. | - | - | 10 | 30 | 200mA | 25V |
| 24 | NFW31SP307X1E4 | 10 | 300MHz | - | - | - | - | - | - | 6dB max. | - | 5 | 15 | 200mA | 25V |
| 25 | NFW31SP407X1E4 | 10 | 400MHz | - | - | - | - | - | - | - | 6dB max. | - | 10 | 200mA | 25V |
| 26 | NFW31SP507X1E4 | 10 | 500MHz | - | - | - | - | - | - | - | - | 6dB max. | 10 | 200mA | 25V |

●EKEMFA20E (Chip EMIFIL® LC Combined Array Type)

| No. | Part Number | Quantity (pcs.) | Cut-off Frequency | Rated Voltage (Vdc) | Rated Current (mA) | Insulation Resistance (MΩ min.) |
|-----|------------------------|-----------------|-------------------|---------------------|--------------------|---------------------------------|
| 1 | NFA18SL137V1A45 | 10 | 130MHz | 10 | 50 | 1000 |
| 2 | NFA18SL187V1A45 | 10 | 180MHz | 10 | 50 | 1000 |
| 3 | NFA18SL207V1A45 | 10 | 200MHz | 10 | 50 | 1000 |
| 4 | NFA18SL307V1A45 | 10 | 300MHz | 10 | 100 | 1000 |
| 5 | NFA18SL407V1A45 | 10 | 400MHz | 10 | 100 | 1000 |
| 6 | NFA18SL487V1A45 | 10 | 480MHz | 10 | 100 | 1000 |
| 7 | NFA21SL506X1A48 | 10 | 50MHz | 10 | 20 | 1000 |
| 8 | NFA21SL806X1A48 | 10 | 80MHz | 10 | 20 | 1000 |
| 9 | NFA21SL207X1A45 | 10 | 200MHz | 10 | 100 | 1000 |
| 10 | NFA21SL207X1A48 | 10 | 200MHz | 10 | 100 | 1000 |
| 11 | NFA21SL307X1A45 | 10 | 300MHz | 10 | 100 | 1000 |
| 12 | NFA21SL307X1A48 | 10 | 300MHz | 10 | 100 | 1000 |

Continued on the following page. ↗

Chip EMI Suppression Filter Design Kits

Continued from the preceding page.

| No. | Part Number | Quantity (pcs.) | Cut-off Frequency | Rated Voltage (Vdc) | Rated Current (mA) | Insulation Resistance (MΩ min.) |
|-----|-----------------|-----------------|-------------------|---------------------|--------------------|---------------------------------|
| 13 | NFA21SL287V1A45 | 10 | 280MHz | 10 | 100 | 1000 |
| 14 | NFA21SL287V1A48 | 10 | 280MHz | 10 | 100 | 1000 |
| 15 | NFA21SL317V1A45 | 10 | 310MHz | 10 | 100 | 1000 |
| 16 | NFA21SL317V1A48 | 10 | 310MHz | 10 | 100 | 1000 |
| 17 | NFA21SL337V1A45 | 10 | 330MHz | 10 | 100 | 1000 |
| 18 | NFA21SL337V1A48 | 10 | 330MHz | 10 | 100 | 1000 |

●EKEMNFMPH (Chip EMIFIL[®] for Large Current)

| No. | Part Number | Quantity (pcs.) | Capacitance | Rated Voltage (Vdc) | Rated Current (A) | Insulation Resistance (MΩ min.) |
|-----|----------------|-----------------|-----------------|---------------------|-------------------|---------------------------------|
| 1 | NFM18PC104R1C3 | 10 | 0.1μF±20% | 16 | 2 | 1000 |
| 2 | NFM18PC224R0J3 | 10 | 0.22μF±20% | 6.3 | 2 | 1000 |
| 3 | NFM18PC474R0J3 | 10 | 0.47μF±20% | 6.3 | 2 | 1000 |
| 4 | NFM18PC105R0J3 | 10 | 1μF±20% | 6.3 | 2 | 500 |
| 5 | NFM18PC225B0J3 | 10 | 2.2μF±20% | 6.3 | 2 | 200 |
| 6 | NFM18PC225B1A3 | 10 | 2.2μF±20% | 10 | 4 | 200 |
| 7 | NFM18PS474R0J3 | 10 | 0.47μF±20% | 6.3 | 2 | 1000 |
| 8 | NFM18PS105R0J3 | 10 | 1μF±20% | 6.3 | 2 | 500 |
| 9 | NFM21PC104R1E3 | 10 | 0.1μF±20% | 25 | 2 | 1000 |
| 10 | NFM21PC224R1C3 | 10 | 0.22μF±20% | 16 | 2 | 1000 |
| 11 | NFM21PC474R1C3 | 10 | 0.47μF±20% | 16 | 2 | 1000 |
| 12 | NFM21PC105B1A3 | 10 | 1μF±20% | 10 | 4 | 500 |
| 13 | NFM21PC105B1C3 | 10 | 1μF±20% | 16 | 4 | 500 |
| 14 | NFM21PC225B0J3 | 10 | 2.2μF±20% | 6.3 | 4 | 200 |
| 15 | NFM21PC475B1A3 | 10 | 4.7μF±20% | 10 | 6 | 100 |
| 16 | NFE31PC276B0J3 | 10 | 27μF±20% | 6.3 | 6 | 20 |
| 17 | NFE31PT152Z1E9 | 10 | 1500pF +50/-20% | 25 | 6 | 1000 |
| 18 | NFE31PT22Z1E9 | 10 | 2200pF±50% | 25 | 6 | 1000 |
| 19 | NFE61PT102E1H9 | 10 | 1000pF +80/-20% | 50 | 2 | 1000 |
| 20 | NFE61PT472C1H9 | 10 | 4700pF +80/-20% | 50 | 2 | 1000 |
| 21 | NFM41PC204F1H3 | 10 | 0.2μF +80/-20% | 50 | 2 | 1000 |
| 22 | NFM41PC155B1E3 | 10 | 1.5μF±20% | 25 | 6 | 300 |

●EKEMDL21J (Chip Common Mode Choke Coils)

| No. | Part Number | Quantity (pcs.) | Common Mode Impedance (at 100MHz, 20 degrees C) | Rated Voltage (Vdc) | Rated Current (mA) | Insulation Resistance (MΩ min.) |
|-----|---------------|-----------------|---|---------------------|--------------------|---------------------------------|
| 1 | DLW21HN670SQ2 | 10 | 67Ω±25% | 50 | 330 | 10 |
| 2 | DLW21HN900SQ2 | 10 | 90Ω±25% | 50 | 330 | 10 |
| 3 | DLW21HN121SQ2 | 10 | 120Ω±25% | 50 | 280 | 10 |
| 4 | DLW21HN181SQ2 | 10 | 180Ω±25% | 50 | 250 | 10 |
| 5 | DLW21SN670SQ2 | 10 | 67Ω±25% | 50 | 400 | 10 |
| 6 | DLW21SN900SQ2 | 10 | 90Ω±25% | 50 | 330 | 10 |
| 7 | DLW21SN121SQ2 | 10 | 120Ω±25% | 50 | 370 | 10 |
| 8 | DLW21SN181SQ2 | 10 | 180Ω±25% | 50 | 330 | 10 |
| 9 | DLW21SN261SQ2 | 10 | 260Ω±25% | 50 | 300 | 10 |
| 10 | DLW21SN371SQ2 | 10 | 370Ω±25% | 50 | 280 | 10 |
| 11 | DLW21SN670HQ2 | 10 | 67Ω±25% | 20 | 320 | 10 |
| 12 | DLW21SN900HQ2 | 10 | 90Ω±25% | 20 | 280 | 10 |
| 13 | DLW21SN121HQ2 | 10 | 120Ω±25% | 20 | 280 | 10 |
| 14 | DLW21SR670HQ2 | 10 | 67Ω±25% | 20 | 400 | 10 |

Continued on the following page. 

Chip EMI Suppression Filter Design Kits

Continued from the preceding page.

| No. | Part Number | Quantity (pcs.) | Common Mode Impedance (at 100MHz, 20 degrees C) | Rated Voltage (Vdc) | Rated Current (mA) | Insulation Resistance (MΩ min.) |
|-----|---------------|-----------------|---|---------------------|--------------------|---------------------------------|
| 15 | DLP0NSN670HL2 | 10 | 67Ω±20% | 5 | 110 | 100 |
| 16 | DLP0NSN900HL2 | 10 | 90Ω±20% | 5 | 100 | 100 |
| 17 | DLP0NSN121HL2 | 10 | 120Ω±20% | 5 | 90 | 100 |
| 18 | DLP11SN670SL2 | 10 | 67Ω±20% | 5 | 180 | 100 |
| 19 | DLP11SN121SL2 | 10 | 120Ω±20% | 5 | 140 | 100 |
| 20 | DLP11SN161SL2 | 10 | 160Ω±20% | 5 | 120 | 100 |
| 21 | DLP11SN900HL2 | 10 | 90Ω±20% | 5 | 150 | 100 |
| 22 | DLP11SN201HL2 | 10 | 200Ω±20% | 5 | 110 | 100 |
| 23 | DLP11SN241HL2 | 10 | 240Ω±20% | 5 | 100 | 100 |
| 24 | DLP11SN281HL2 | 10 | 280Ω±20% | 5 | 90 | 100 |
| 25 | DLP11SN331HL2 | 10 | 330Ω±20% | 5 | 80 | 100 |
| 26 | DLP11SA350HL2 | 10 | 35Ω±25% | 5 | 170 | 100 |
| 27 | DLP11SA670HL2 | 10 | 67Ω±25% | 5 | 150 | 100 |
| 28 | DLP11SA900HL2 | 10 | 90Ω±25% | 5 | 150 | 100 |
| 29 | DLP2ADN670HL4 | 10 | 67Ω±20% | 5 | 140 | 100 |
| 30 | DLP2ADN900HL4 | 10 | 90Ω±20% | 5 | 130 | 100 |
| 31 | DLP2ADN121HL4 | 10 | 120Ω±20% | 5 | 120 | 100 |
| 32 | DLP2ADN161HL4 | 10 | 160Ω±20% | 5 | 100 | 100 |
| 33 | DLP2ADN201HL4 | 10 | 200Ω±20% | 5 | 90 | 100 |
| 34 | DLP2ADN241HL4 | 10 | 240Ω±20% | 5 | 80 | 100 |
| 35 | DLP2ADN281HL4 | 10 | 280Ω±20% | 5 | 80 | 100 |

●EKEMDCC5B (Chip Common Mode Choke Coils for DC Power Line / SMD Block type EMIFIL® for Power Line)

| No. | Part Number | Quantity (pcs.) | Common Mode Impedance (at 100MHz, 20 degrees C) | Rated Voltage (Vdc) | Rated Current (mA) | Insulation Resistance (MΩ min.) |
|-----|---------------|-----------------|---|---------------------|--------------------|---------------------------------|
| 1 | DLW5AHN402SQ2 | 5 | 4000Ω (Typ.) | 50 | 200 | 10 |
| 2 | DLW5BSN191SQ2 | 5 | 190Ω (Typ.) | 50 | 5000 | 10 |
| 3 | DLW5BSN351SQ2 | 5 | 350Ω (Typ.) | 50 | 2000 | 10 |
| 4 | DLW5BSN102SQ2 | 5 | 1000Ω (Typ.) | 50 | 1500 | 10 |
| 5 | DLW5BSN152SQ2 | 5 | 1500Ω (Typ.) | 50 | 1000 | 10 |
| 6 | DLW5BSN302SQ2 | 5 | 3000Ω (Typ.) | 50 | 500 | 10 |
| 7 | DLW5BTN101SQ2 | 5 | 100Ω (Typ.) | 50 | 6000 | 10 |
| 8 | DLW5BTN251SQ2 | 5 | 250Ω (Typ.) | 50 | 5000 | 10 |
| 9 | DLW5BTN501SQ2 | 5 | 500Ω (Typ.) | 50 | 4000 | 10 |
| 10 | DLW5BTN102SQ2 | 5 | 1000Ω (Typ.) | 50 | 2000 | 10 |
| 11 | DLW5BTN142SQ2 | 5 | 1400Ω (Typ.) | 50 | 1500 | 10 |

| No. | Part Number | Quantity (pcs.) | Insertion Loss | Rated Voltage (Vdc) | Rated Current (A) | Insulation Resistance (MΩ min.) |
|-----|-------------|-----------------|-------------------------|---------------------|-------------------|---------------------------------|
| 12 | BNX022-01 | 5 | 1MHz to 1GHz: 35dB min. | 50 | 10 | 500 |
| 13 | BNX023-01 | 5 | 1MHz to 1GHz: 35dB min. | 100 | 15 | 500 |

Outlines of Major Noise Regulation Standards

1. EMI Regulations

| Equipment | | Countries | Information Regulation | Japan | USA | Europe |
|-----------|---|-----------|---|---|---|---|
| Emission | Generic Standard | | CISPR61000-6-3 (Residential, Commercial and Light Industry) IEC61000-6-4 (Industrial) | | | EN50081-1 (Residential, Commercial and Light Industry) EN50081-2 (Industrial) |
| | ITE: Information Technology Equipment Printers, Personal computers Word processors, Displays | | CISPR 22 | VCCI *1 | FCC Part 15 Subpart B | EN55022 |
| | ISM equipment, Microwaves | | CISPR 11 | *1 | FCC Part 18 | EN55011 |
| | Igniter (Automobiles, Motorboats) | | CISPR 12 | JASO | FCC Part 15 Subpart B | Automotive Directive |
| | TVs, Radios, Audios, VTRs | | CISPR 13 | *1 | FCC Part 15 Subpart B | EN55013 |
| | Household electrical equipment Portable tools | | CISPR 14 | *1 | | EN55014 |
| | Fluorescent Lamps, Luminaries | | CISPR 15 | *1 | FCC Part 18 | EN55015 |
| | Transceivers | | ITU-T | Radio Act ARIB (Voluntary Regulation) | FCC Part 15 Subpart C FCC Part 22 | ETS300 Series |
| | (Reference) Power Supplies Higher Harmonics | | IEC61000-3 | Industrial Voluntary Regulation | | EN61000-3 |
| Immunity | Basic Standard | | IEC61000-4 | JIS C 61000-4 | | EN61000-4 Series |
| | Generic Standard | | IEC61000-6-1 (Residential, Commercial and Light Industry) IEC61000-6-2 (Industrial) | JIS C 61000-6-1 (Residential, Commercial and Light Industry) JIS C 61000-6-2 (Industrial) | | EN50082-1 (Residential, Commercial and Light Industry) EN50082-2 (Industrial) |
| | Industrial Process Measurement and Control Equipment | | | | | |
| | Radios, TVs | | CISPR 20 | Industrial Voluntary Action | | EN55020 |
| | ITE: Information Technology Equipment | | CISPR 24 | | | EN55024 |

*1 Electrical Appliance and Material Safety Law

There are EMI regulations in each country to meet EMI noise levels emitted from digital equipment.
 In the countries which regulate EMI, equipment which does not satisfy regulations is not allowed to be sold.

Continued on the following page.

Outlines of Major Noise Regulation Standards

Continued from the preceding page.

2. Measurement Point and Noise Detection

| Regulation | Measuring Item | Polarization and Measuring Point | Frequency (Hz) | Detection | Measuring Devices |
|----------------------|---------------------------|----------------------------------|----------------|-------------------------------------|-------------------------|
| CISPR 22/ EN55022 | Radiated Interference | Horizontal Pol. Vertical Pol. | 30M to 1GHz | Quasi-Peak Detection | Antenna |
| | Main Interference Voltage | AC Main Ports | 150k to 30MHz | Quasi-Peak Detection Mean Detection | Artificial Main Network |
| VCCI | Radiated Interference | Horizontal Pol. Vertical Pol. | 30M to 1GHz | Quasi-Peak Detection | Dipole Antenna |
| | Main Interference Voltage | AC Main Ports | 150k to 30MHz | Quasi-Peak Detection Mean Detection | Artificial Main Network |
| FCC Part 15 | Radiated Interference | Horizontal Pol. Vertical Pol. | 30M to 40GHz | Quasi-Peak Detection Mean Detection | Antenna |
| | Main Interference Voltage | AC Main Ports | 150k to 30MHz | Quasi-Peak Detection | Artificial Main Network |

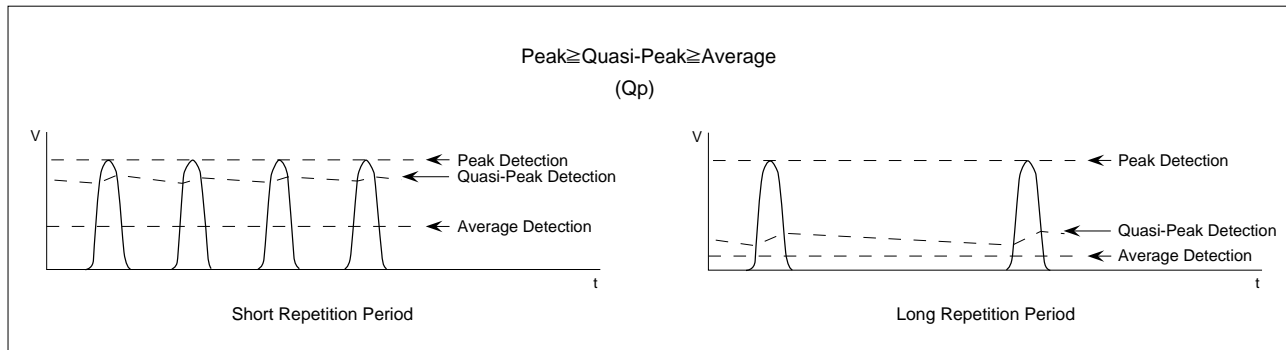

3. Limits of CISPR 22/EN55022

(1) CISPR 22 recommends measurement at 10m distance. However, other distance is acceptable if the limitation is converted according to the following calculation. Limitation shown left is converted to limitation for 3m distance.

Conversion

| | | |
|-----------------------------|---|----------------------------------|
| Limitation for 10m Distance | → | Limitation for 3m Distance |
| R_{10} (dB μ V/m) | | R_3 (dB μ V/m) |
| r_{10} (μ V/m) | | r_3 (μ V/m) |
| $R_{10} = 20 \log r_{10}$ | | $R_3 = 20 \log r_3$ |
| | | $R_3 = R_{10} + 20 (1 - \log 3)$ |
| | | $r_3 = \frac{10}{3} r_{10}$ |

Main Terminal Interference Voltage (Power Supply)

| Class | Quasi-peak value (dBμV) | Mean value (dBμV) |
|---------|-------------------------|-------------------|
| Class A | 73 | 60 |
| Class B | 50 | 46 |

Radiated Interference

| Class | Field Strength (dBμV/m) |
|---------|-------------------------|
| Class A | 57 |
| Class B | 47 |

On the border frequency, lower limit should be applied.

Class A Equipment: The equipment which is used in light industrial commercial areas.
 Class B Equipment: The equipment which is used in residential areas.

Continued on the following page. ↗

Outlines of Major Noise Regulation Standards

☒ Continued from the preceding page.

(2) Scope of CISPR 22 Regulation

This regulation applies to information technology equipment (ITE) which is defined as:

- (a) Equipment that receives data from external signal sources;
- (b) Equipment that processes received data;
- (c) Equipment that outputs data; and
- (d) Equipment that has less than 600V rated voltage in power supply.

CISPR Regulations

- CISPR 10 Organization, Regulations and Procedures of CISPR
- CISPR 11 Industrial, Scientific and Medical (ISM) Radio-Frequency Equipment
- CISPR 12 Vehicles, Motor Boats and Spark-Ignited Engine driven
- CISPR 13 Sound and Television Receivers
- CISPR 14 Household Electrical Appliances, Portable Tools and Similar Electrical Apparatus
- CISPR 15 Fluorescent Lamps and luminaries
- CISPR 16 Radio Interference Measuring Apparatus and Measurement Methods
- CISPR 17 Passive Radio Interference Filters and Suppression Components
- CISPR 18 Power Transmission Cables and High Voltage equipment
- CISPR 19 Microwave Ovens for Frequencies above 1GHz
- CISPR 20 Immunity of Sound and TV Broadcast Receivers and Associated Equipment
- CISPR 21 Interference to Mobile Radio Communications in the Presence of Impulsive Noise
- CISPR 22 Information Technology Equipment
- CISPR 23 Industrial Scientific and Medical (ISM) Equipment
- CISPR 24 Immunity Regulation of Information Technology Equipment
- CISPR 25 Receiver used onboard vehicles, boats, and on devices

4. Limits of VCCI Voluntary Regulation

- (1) VCCI recommends measurement at 10m distance; 3m or 30m distance measurements are also allowed.

(2) Scope of VCCI Voluntary Regulation

This regulation applies to information technology equipment (same as CISPR Pub.22), but the application is excluded on the following equipment:

- Equipment for which other regulations already exist (e.g., household electrical appliances, radio and TV receivers)
- In station equipment principal purpose of which is electrical communication
- Industrial plant control system for which information processing is a secondary system function
- Industrial, commercial and medical testing and measuring systems for which data processing is a secondary system function
- Information equipment for which CISPR is conducting further deliberation

VCCI is the acronym of Voluntary Control Council for Interference by Data Processing Equipment and Electronic Office Machines.

VCCI is organized by the following organizations:

- Japan Electronics and Information Technology Industries Association (JEITA)
- Japan Business Machine and Information System Industries Association (JBMIA)
- Communication and Information Network Association of Japan (CIAJ)

Main Terminal Interference Voltage (Power Supply)

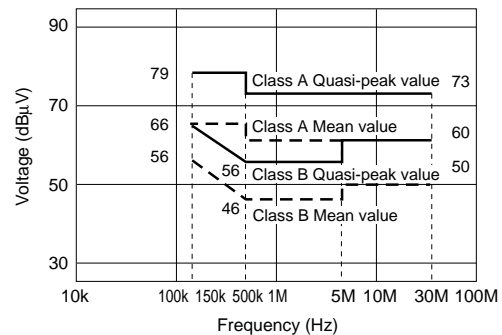

Radiated Interference

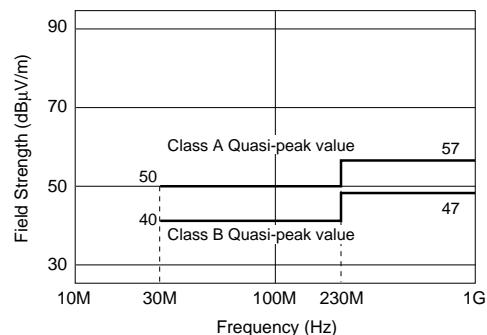

On the border frequency, lower limit should be applied.

Class B ITE: Equipment that is designed to be used at home.

Class A ITE: Equipment that does not meet interference limits of class B equipment, but satisfies interference limits of class A equipment.

Continued on the following page. ☒

Outlines of Major Noise Regulation Standards

☞ Continued from the preceding page.

5. Limits of FCC Part 15 Subpart B

- (1) Class A recommended to be measured with 10m distance.
Class B recommended to be measured with 3m distance.
- (2) The FCC Part 15 regulation controls radiated interference by establishing quasi-peak and mean value limits for frequencies ranging from 30MHz to 40GHz (or maximum frequency's fifth harmonic, whichever is lower).
For AC main ports, the FCC Part 15 regulation controls main terminal interference voltage by establishing quasipeak value limits for frequencies ranging from 450kHz to 30MHz.

Measurement Frequency Range for Radiated Interference

| Maximum Frequency the Equipment Internally Generates, Uses or Operates or Synchronizes (MHz) | Upper End of Measurement Frequency Range (MHz) |
|--|---|
| Less than 1.705 | 30 |
| 1.705 to 108 | 1000 |
| 108 to 500 | 2000 |
| 500 to 1000 | 5000 |
| Over 1000 | Maximum Frequency's Fifth Harmonic or 40GHz, Whichever is Lower |

Main Terminal Interference Voltage (Power Supply)

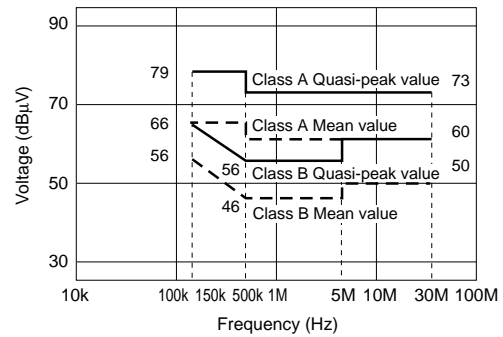

Radiated Interference

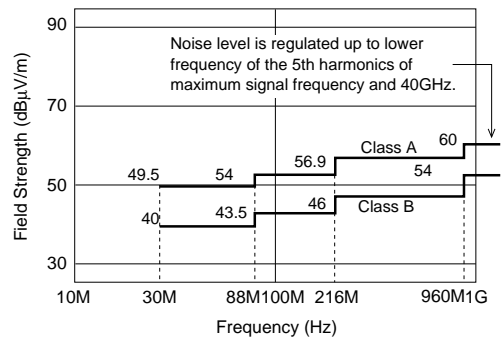

On the border frequency, lower limit should be applied.

Class A Equipment: The digital equipment that is sold for commercial, industrial and office use.

Class B Equipment: The digital equipment that is sold to be used in residential areas.

- (3) There is no regulation on power interference.

FCC Regulations

- Part 1 Procedures
- Part 2 Frequency Division and Radio Wave Treaty Issues and General Rules
- Part 15 Radio Wave Equipment
 - Intentionally electromagnetic radiation equipment
 - Non-intentionally electromagnetic radiation equipment
 - Incidentally electromagnetic radiation equipment
- Part 18 Industrial, Scientific and Medical Equipment
- Part 22 Public Mobile Wireless Operations
- Part 68 Connecting Terminal Equipment to Telephone Circuit Network
- Part 76 Cable Television

Continued on the following page. ☞

Outlines of Major Noise Regulation Standards

☞ Continued from the preceding page.

6. Immunity Regulations in the European Union

All electric/electronic equipment cannot be sold in Europe without CE marking. To use CE marking, they must satisfy related EC directives such as EMC directives. For Information Technology Equipment, in EMC directive, emission regulations are integrated, and immunity regulations are applied. Although these immunity regulations are prepared by CENELEC, almost all contents are same as standards issued by IEC or CISPR.

All products which are sold in EU must satisfy EC directives which contain immunity regulations.

| Principal EC Directive | |
|---|-------------------------|
| EMC Directive | 89/336/EEC 92/31/EEC |
| Low-Voltage Electrical Products Directive | 73/23/EEC |
| Machines Directive | 89/392/EEC |

7. Immunity Regulations in Japan

| Equipment | Association |
|--|--|
| TV, Radio, Audio | JEITA (Japan Electronics and Information Technology) |
| ITE | |
| Office Machine | JBMA (Japan Business Machine and Information System Industries Association) |
| Mi | CIAJ (Communication and Information Network Association of Japan) ARIB (Association of Radio Industries and Business) |
| Machine To Builders | JMTBA (Japan Machine Tool Builders' Association) |
| Industrial Measuring Control Equipment | JEMIMA (Japan Electric Measuring Instruments Manufacturers' Association) |
| Industrial Robot | JARA (Japan Robot Association) |

The table on the right shows the preparation situation of JIS for EMC. At this moment, the immunity standards by JIS do not have a legal force like the Electrical Application and Material Safety Law/VCCI.

| Classification | Information Regulation | JIS |
|-------------------|---------------------------------|------------------|
| Terms | ISO60050-161 (IEV terms 161) | JIS C 0161 |
| Basic Standards | IEC61000-4- 2 | JIS C 61000-4-2 |
| | IEC61000-4- 3 | JIS C 61000-4-3 |
| | IEC61000-4- 4 | JIS C 61000-4-4 |
| | IEC61000-4- 5 | JIS C 61000-4-5 |
| | IEC61000-4- 6 | JIS C 61000-4-6 |
| | IEC61000-4- 7 | JIS C 61000-4-7 |
| | IEC61000-4- 8 | JIS C 61000-4-8 |
| | IEC61000-4-11 | JIS C 61000-4-11 |
| | IEC61000-4-14 | JIS C 61000-4-14 |
| | IEC61000-4-17 | JIS C 61000-4-17 |
| Generic Standards | IEC61000-6-1 | JIS C 61000-6-1 |
| | IEC61000-6-2 | JIS C 61000-6-2 |

Principles of Noise Suppression by DC EMIFIL®

1. Function of DC EMI Suppression Filters

DC EMI suppression filters absorb and eliminate high frequency noise which may produce electromagnetic interference in PC board circuits.

These filters are used in secondary circuits, and are small in size and light in weight, which further enhances their excellent noise suppression functions.

Chip and adhesive type filters can be mounted on PC boards automatically.

These filters are effective in the suppression of radiation noise in computers, peripheral equipment, and digital circuit application equipment (including various types of microcomputer application equipment), and function to suppress noise in audio/visual equipment, which uses digital memory chips and DSP.

These filters are also effective for improving the noise immunity of equipment used in noisy environments (such as electronic equipment for automobiles).

2. Noise Filter Suppression Principles

Generally, noise problems occur when the noise source and electronic equipment sensitive to the influence of noise are located in close proximity to one another.

In such situations, as shown in Figure at right, noise is conducted through a conductor, which produces an inductive field around the noise source.

To overcome such noise problems, it is preferable to reduce the amount of noise generated by the noise source or improve the noise resistance of adjacent equipment.

In order to satisfy equipment performance specifications and eliminate noise effectively at the same time, however, it is customary to reduce the amount of noise generated by the noise source, if it can't be eliminated altogether.

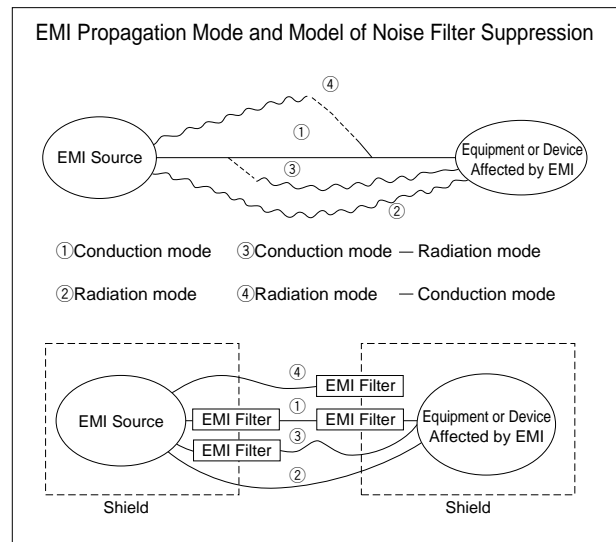

3. Configuration of EMI Suppression Filters (DC)

DC EMI suppression filters are used to suppress noise produced by conductors. Noise radiation can be suppressed, if it is eliminated with a filter in advance.

Generally, such noise suppression is achieved with DC EMI suppression filters, according to the capacitive and inductive frequency characteristics of the respective conductors in the circuit.

Filters of this kind can be roughly divided into those:

- (1) employing a capacitor,
- (2) employing an inductor,
- (3) employing a capacitor and inductor combination.

Continued on the following page. ↗

Principles of Noise Suppression by DC EMIFIL[®]

Continued from the preceding page.

4. Capacitive Noise Suppression

When a capacitor is connected (bypass capacitor) to ground from a noisy signal line or power line, the circuit impedance decreases as the frequency increases. Since noise is a high frequency phenomenon, it flows to ground if a capacitor has been connected to ground, thereby making it possible to eliminate noise. (See Fig.) EMI suppression filters employing a capacitor in this way are used to eliminate this type of noise.

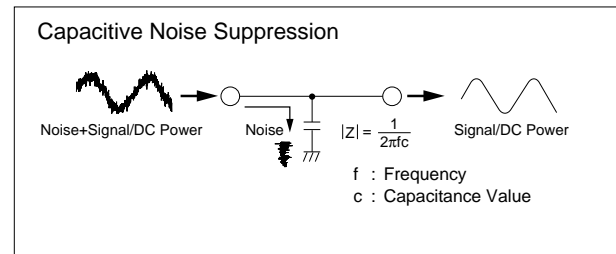

5. High frequency Capacitor Characteristics Used for EMI Suppression Filters

Even general-purpose capacitors can be used for noise suppression. However, since noise has an extremely high frequency range, general-purpose capacitors may not function as effective bypass capacitors, due to the large residual inductance built into the capacitor. All the capacitors used in Murata's EMI suppression filters employ a three terminal structure or thru-type structure, which functions effectively even at high frequencies, thereby minimizing the influence of residual inductance. Consequently, an effective filter circuit can be formed even at frequencies exceeding 1GHz. (Refer to Fig.)

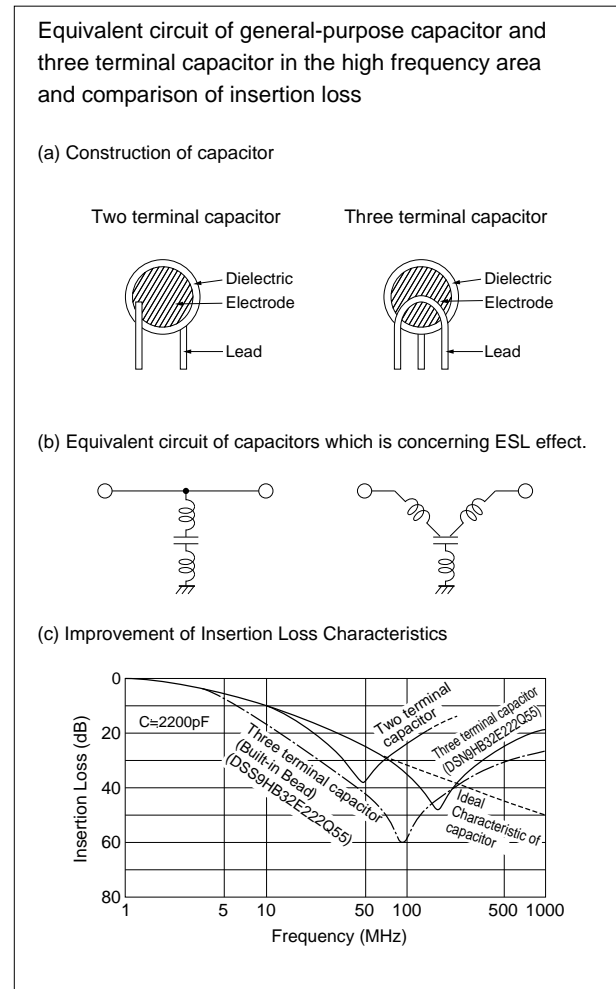

6. Inductive Noise Suppression

When an inductor is inserted in series in a noise producing circuit (See Fig.), its impedance increases with frequency. In this configuration it is possible to attenuate and eliminate noise components (high frequency components). The Murata EMI suppression filter functions in this way.

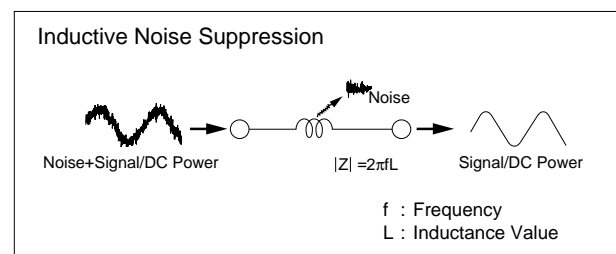

Continued on the following page. ↗

Principles of Noise Suppression by DC EMIFIL®

☐ Continued from the preceding page.

7. Characteristics of Inductors Used in EMI Suppression Filters

General-purpose inductors also function to suppress noise when configured in series with a noise producing circuit. However, when general-purpose inductors are used, resonance may result in peripheral circuits, signal wave forms may become distorted, and satisfactory impedance may not be obtained at noise frequencies (due to insufficient high frequency impedance characteristics).

The inductors used for Murata's EMI suppression filters are designed to function nearly as a resistor at noise frequencies, which greatly reduces the possibility of resonance and leaves signal wave forms undistorted. And since sufficient impedance is obtained for frequencies ranging to hundreds of MHz, these specifically designed inductors operate effectively to suppress high-frequency noise. (See Fig.)

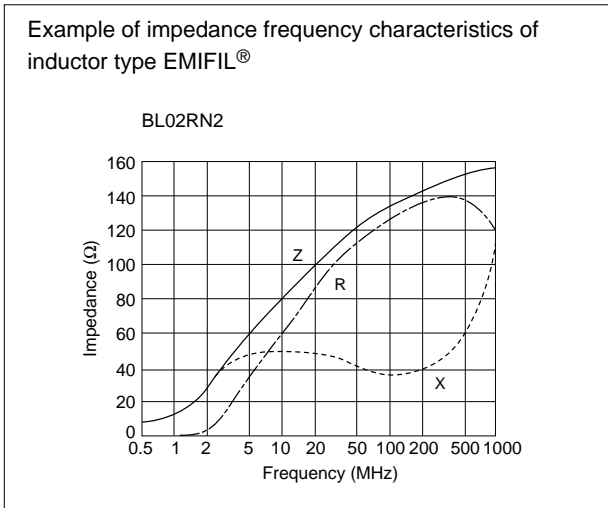
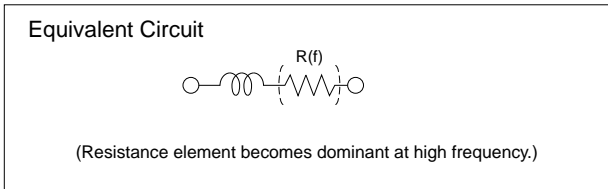

8. Capacitive-Inductive EMI Suppression Filters

If capacitive and inductive suppression characteristics are combined, it is possible to configure a much higher performance filter. In signal circuit applications where this combination is applied, noise suppression effects which have little influence on the signal wave form become possible.

This type of filter is also effective in the suppression of high-speed signal circuit noise. When used in DC power circuits, capacitive-inductive filters prevent resonance from occurring in peripheral circuits, thus making it possible to achieve significant noise suppression under normal service conditions.

9. Other EMI Suppression Filters

In addition to the capacitive-inductive filter, Murata also has an EMI suppression filter (EMIGUARD®) combining a capacitor with a varistor, useful for surge absorption; and a common mode choke coil effective, for common mode noise suppression.

Murata also has a range of built-in filter connectors which greatly reduce filter mounting space requirements.

Continued on the following page. ☐

Principles of Noise Suppression by DC EMIFIL®

☞ Continued from the preceding page.

10. Expressing EMI Suppression Filter Effects

EMI Suppression Filter effects are expressed in terms of the insertion loss measured in the circuit, normally specified in MIL-STD 220A. As shown in the 50Ω impedance circuit in the Figure at right, insertion loss is represented by the logarithmic ratio of the circuit output voltage with and without a filter in the circuit, which is multiplied by 20 and expressed in dB.

Therefore, an insertion loss of 20dB indicates an output voltage ratio (B/C) of 1/10, and an insertion loss of 40dB indicates an output voltage ratio (B/C) of 1/100.

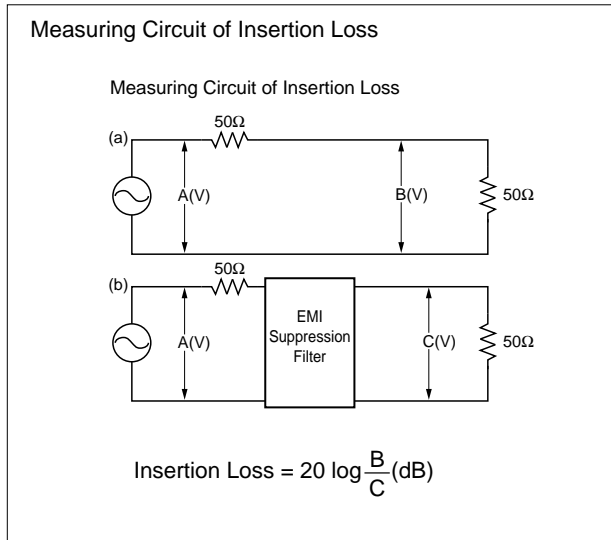



Murata EMI Filter Selection Simulator Ver. 3.6.0

New products are available

1 Select circuit.

(Select a new simulation circuit from File menu.)

2 Enter "Input Signal".

3 Set Driver IC.

4 Select filter.

(EMI filters or/and chip capacitor from the pull-down list.)

5 Set Transmission Line.

6 Set Receiver IC.

7 Click measuring point.

(Only for chip ferrite bead)

8 Click "Start Simulation" button.

9 Simulation results are displayed.

- Simulation results with various charts are quickly displayed on your PC.
- Results can be displayed in standard format or user defined scaling.
- Simulates various types of circuits such as Differential Mode Transmission, ceramic capacitor, EMIFIL®, three terminal capacitor and chip ferrite beads.
- Provides a simulation function that selects best suited Chip EMIFIL®.

1 Select circuit.

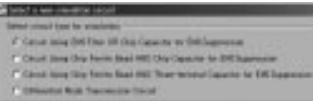

Select a new simulation circuit from File menu.

4 Filters can be selected from "frequency-impedance characteristics" charts.



9 Simulation results are shown in the window.

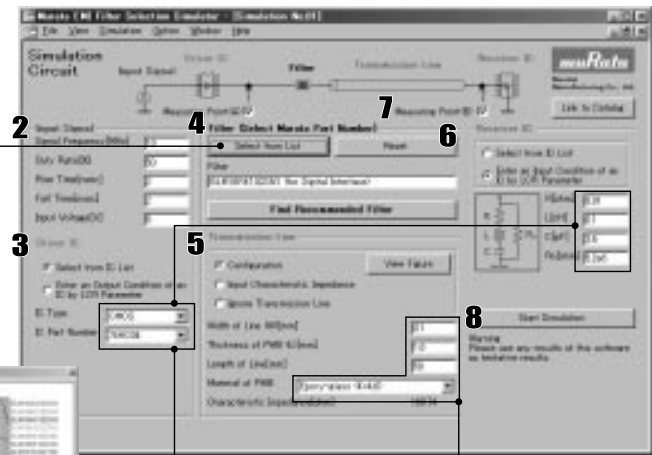
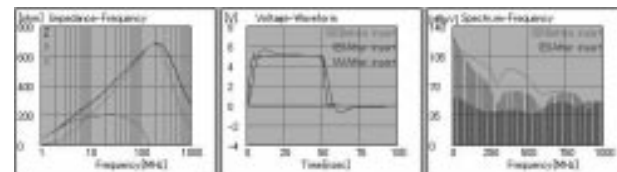

Two ways of setting the driver/receiver IC parameter

The logic IC of TTL and CMOS can be selected from pull-down list or the LCR values can also be created.

Impedance automatically calculated.

Impedance characteristics of transmission line are automatically calculated.

Link to the web catalog is available

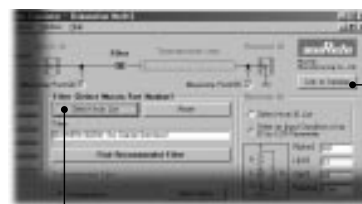

This button allows you to see more information at web catalog. (Need connection to the Internet)



EMIFIL® is the trademark of Murata Manufacturing Co., Ltd.

This simulator can be downloaded from Murata's website.

<http://www.murata.com/designlib/mefss/>



△Note:

1. Export Control

<For customers outside Japan>

No muRata products should be used or sold, through any channels, for use in the design, development, production, utilization, maintenance or operation of, or otherwise contribution to (1) any weapons (Weapons of Mass Destruction [nuclear, chemical or biological weapons or missiles] or conventional weapons) or (2) goods or systems specially designed or intended for military end-use or utilization by military end-users.

<For customers in Japan>

For products which are controlled items subject to the "Foreign Exchange and Foreign Trade Law" of Japan, the export license specified by the law is required for export.

2. Please contact our sales representatives or product engineers before using the products in this catalog for the applications listed below, which require especially high reliability for the prevention of defects which might directly damage a third party's life, body or property, or when one of our products is intended for use in applications other than those specified in this catalog.

- | | |
|-----------------------------|--|
| ① Aircraft equipment | ② Aerospace equipment |
| ③ Undersea equipment | ④ Power plant equipment |
| ⑤ Medical equipment | ⑥ Transportation equipment (vehicles, trains, ships, etc.) |
| ⑦ Traffic signal equipment | ⑧ Disaster prevention / crime prevention equipment |
| ⑨ Data-processing equipment | ⑩ Application of similar complexity and/or reliability requirements to the applications listed above |

3. Product specifications in this catalog are as of July 2008. They are subject to change or our products in it may be discontinued without advance notice. Please check with our sales representatives or product engineers before ordering. If there are any questions, please contact our sales representatives or product engineers.

4. Please read rating and △ CAUTION (for storage, operating, rating, soldering, mounting and handling) in this catalog to prevent smoking and/or burning, etc.

5. This catalog has only typical specifications because there is no space for detailed specifications. Therefore, please approve our product specifications or transact the approval sheet for product specifications before ordering.

6. Please note that unless otherwise specified, we shall assume no responsibility whatsoever for any conflict or dispute that may occur in connection with the effect of our and/or a third party's intellectual property rights and other related rights in consideration of your use of our products and/or information described or contained in our catalogs. In this connection, no representation shall be made to the effect that any third parties are authorized to use the rights mentioned above under licenses without our consent.

7. No ozone depleting substances (ODS) under the Montreal Protocol are used in our manufacturing process.



<http://www.murata.com/>

Head Office
1-10-1, Higashi Kotari, Nagaokakyo-shi, Kyoto 617-8555, Japan
Phone: 81-75-951-9111

International Division
3-29-12, Shibuya, Shibuya-ku, Tokyo 150-0002, Japan
Phone: 81-3-5469-6123 Fax: 81-3-5469-6155 E-mail: intl@murata.co.jp