

## Wirewound Resistors, Industrial Power, Tubular (HL), Non-Inductive Tubular (NHL)

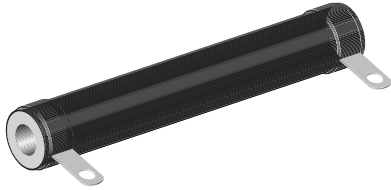

### FEATURES

- High temperature silicon coating
- Complete welded construction
- Available in non-inductive styles (model NHL) with Aryton-Perry winding
- Tight tolerance of 5 % for values above 1  $\Omega$
- Excellent stability in operation (< 3 % change in resistance)



**RoHS\***  
COMPLIANT

STANDARD ELECTRICAL SPECIFICATIONS					
GLOBAL MODEL	HISTORICAL MODEL	POWER RATING $P_{25^\circ\text{C}}$ W	RESISTANCE RANGE $\Omega$		WEIGHT (typical) g
			$\pm 5\%$	$\pm 10\%$	
HL011 NHL011	HL-11 NHL-11	11	1.0 - 70K 1.0 - 4.7K	0.10 - 70K 1.0 - 4.7K	10.50
HL012 NHL012	HL-12 NHL-12	12	1.0 - 58K 1.0 - 3.9K	0.10 - 58K 1.0 - 3.9K	6.69
HL015 NHL015	HL-15 NHL-15	15	1.0 - 60K 1.0 - 4.3K	0.10 - 60K 1.0 - 4.3K	8.64
HL020 NHL020	HL-20 NHL-20	20	1.0 - 95K 1.0 - 6.8K	0.10 - 95K 1.0 - 6.8K	12.57
HL025 NHL025	HL-25 NHL-25	25	1.0 - 115K 1.0 - 8.8K	0.10 - 115K 1.0 - 8.8K	20.72
HL026 NHL026	HL-26 NHL-26	26	1.0 - 170K 1.0 - 11.8K	0.10 - 170K 1.0 - 11.8K	15.34
HL050 NHL050	HL-50 NHL-50	50	1.0 - 112K 1.0 - 21.5K	0.10 - 112K 1.0 - 21.5K	42.08
HL051 NHL051	HL-51 NHL-51	51	1.0 - 124K 1.0 - 22.9K	0.10 - 124K 1.0 - 22.9K	51.96
HL060 NHL060	HL-60 NHL-60	60	1.0 - 145K 1.0 - 27.2K	0.10 - 145K 1.0 - 27.2K	65.64
HL065 NHL065	HL-65 NHL-65	65	1.0 - 170K 1.0 - 31.4K	0.10 - 170K 1.0 - 31.4K	64.82
HL080 NHL080	HL-80 NHL-80	80	1.0 - 190K 1.0 - 38.3K	0.10 - 190K 1.0 - 38.3K	121.58
HL100 NHL100	HL-100 NHL-100	100	1.0 - 260K 1.0 - 48.5K	0.10 - 260K 1.0 - 48.5K	91.37
HL120 NHL120	HL-120 NHL-120	120	1.0 - 330K 1.0 - 64.1K	0.10 - 330K 1.0 - 64.1K	183.82
HL130 NHL130	HL-130 NHL-130	130	1.0 - 380K 1.0 - 70.2K	0.10 - 380K 1.0 - 70.2K	192.36
HL160 NHL160	HL-160 NHL-160	160	1.0 - 470K 1.0 - 105K	0.10 - 470K 1.0 - 105K	245.86
HL175 NHL175	HL-175 NHL-175	175	1.0 - 500K 1.0 - 112K	0.10 - 500K 1.0 - 112K	250.80
HL225 NHL225	HL-225 NHL-225	225	1.0 - 645K 1.0 - 121K	0.10 - 645K 1.0 - 121K	309.97

GLOBAL PART NUMBER INFORMATION																	
New Global Part Numbering: NHL10006Z10R00JJ (preferred part number format)																	
N	H	L	1	0	0	0	6	Z	1	0	R	0	0	J	J		
GLOBAL MODEL	TERMINAL DESIGNATION	TERMINAL FINISH	RESISTANCE VALUE		TOLERANCE	PACKAGING CODE		SPECIAL									
NHL100 <small>(See "Standard Electrical Specifications" table above for additional P/N's)</small>	02 05 06 07 14 15	E = Lead (Pb)-free Z = Tin/lead N = Nickel	R = Decimal K = Thousand 10R00 = 10.0 $\Omega$ 1K000 = 1 k $\Omega$	J = $\pm 5.0\%$ K = $\pm 10.0\%$	E = Lead (Pb)-free skin pack J* = Skin pack (J01)		(Dash Number) (up to 2 digits) From 1 - 99 as applicable										
Historical Part Number Example: NHL-100-06Z 10 $\Omega$ 5 % J01 (will continue to be accepted)																	
NHL-100	06Z	10 $\Omega$	5 %	J01													
HISTORICAL MODEL	TERMINAL/FINISH	RESISTANCE VALUE	TOLERANCE	PACKAGING													

\* Pb containing terminations are not RoHS compliant, exemptions may apply

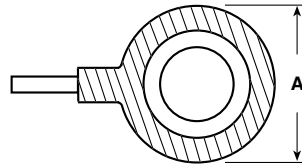
**DIMENSIONS**

(Includes Coating and Terminal Band)

GLOBAL MODEL	DIMENSIONS in inches [millimeters]								
	A (max.)	CORE DIMENSIONS			TERMINAL SETBACK ± 0.031 [± 0.79]	DISTANCE BETWEEN TERMINALS (REF.)	TERMINAL DESIGNATION		MOUNTING HARDWARE OPTIONS
		LENGTH ± 0.062 [± 1.59]	O.D.	I.D. ± 0.031 [± 0.79]			STANDARD	OPTIONAL	
HL011	11.91	1.750	0.375	4.76	0.094	1.187	02	-	101, 204, 301
NHL011	[0.469]	[44.45]	[9.53]	[0.188]	[2.38]				
HL012	10.32	1.750	0.313	4.76	0.094	1.187	05	14	101, 204, 301
NHL012	[0.406]	[44.45]	[7.94]	[0.188]	[2.38]				
HL015	0.563	1.500	0.438	0.313	0.094	0.937	02	14	101, 203, 301
NHL015	[14.29]	[38.10]	[11.11]	[7.94]	[2.38]				
HL020	0.563	2.000	0.438	0.313	0.094	1.437	02	14	101, 203, 301
NHL020	[14.29]	[50.8]	[11.11]	[7.94]	[2.38]				
HL025	0.688	2.000	0.563	0.313	0.094	1.312	06	15	101, 203, 301
NHL025	[17.46]	[50.8]	[14.29]	[7.94]	[2.38]				
HL026	0.563	3.000	0.438	0.313	0.094	2.437	02	14	101, 203, 301
NHL026	[14.29]	[76.2]	[11.11]	[7.94]	[2.38]				
HL050	0.688	4.000	0.563	0.313	0.094	3.312	06	15	101, 203, 301
NHL050	[17.46]	[101.6]	[14.29]	[7.94]	[2.38]				
HL051	0.906	3.500	0.750	0.500	0.125	2.75	06	15	102, 206, 303
NHL051	[23.02]	[88.9]	[19.05]	[12.70]	[3.18]				
HL060	0.906	4.000	0.750	0.500	0.125	3.250	06	15	102, 206, 303
NHL060	[23.02]	[101.6]	[19.05]	[12.70]	[3.18]				
HL065	0.906	114.3	0.750	0.500	0.125	3.750	06	15	102, 206, 303
NHL065	[23.02]	[4.500]	[19.05]	[12.70]	[3.18]				
HL080	1.313	4.000	1.125	0.500	0.219	2.812	07	15	103, 205, 303
NHL080	[33.34]	[101.6]	[28.58]	[12.70]	[5.56]				
HL100	0.906	6.500	0.750	0.500	0.125	5.750	06	15	102, 206, 303
NHL100	[23.02]	[165.1]	[19.05]	[12.70]	[3.18]				
HL120	1.313	6.000	1.125	0.750	0.219	4.812	07	15	103, 205, 303
NHL120	[33.34]	[152.4]	[28.58]	[19.05]	[5.56]				
HL130	1.313	6.500	1.125	0.750	0.219	5.312	07	15	103, 205, 303
NHL130	[33.34]	[165.1]	[28.58]	[19.05]	[5.56]				
HL160	1.313	8.000	1.125	0.750	0.219	6.812	07	15	103, 205, 303
NHL160	[33.34]	[203.2]	[28.58]	[19.05]	[5.56]				
HL175	1.313	8.500	1.125	0.750	0.219	7.312	07	15	103, 205, 303
NHL175	[33.34]	[215.9]	[28.58]	[19.05]	[5.56]				
HL225	1.313	266.7	1.125	0.750	0.219	9.312	07	15	103, 205, 303
NHL225	[33.34]	[10.500]	[28.58]	[19.05]	[5.56]				

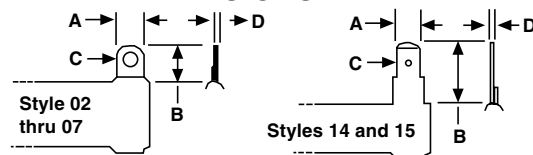
**TERMINAL DIMENSIONS**

**TERMINAL FINISH**

“E” Finish - 100 % Sn coated steel. “Z” Finish - 60/40 SnPb coated steel. “N” Finish - Nickel coated steel. Finish for terminal style 14 and 15 limited to nickel plated steel (N).

DIMENSION	TERMINAL TYPE					
	02	05	06	07	14	15
A	0.188 [4.76]	0.188 [4.76]	0.250 [6.35]	0.375 [9.53]	0.188 [4.76]	0.250 [6.35]
B	0.406 [10.32]	0.438 [11.11]	0.563 [14.29]	0.625 [15.88]	0.563 [14.29]	0.594 [15.08]
C	0.093 [2.36]	0.104 [2.64]	0.166 [4.22]	0.173 [4.39]	0.050 [1.27]	0.065 [1.65]
D	0.020 [0.51]	0.020 [0.51]	0.020 [0.51]	0.020 [0.51]	0.020 [0.51]	0.031 [0.79]

## MOUNTING HARDWARE DIMENSIONS in inches [millimeters]

### Horizontal Thru-Bolt

(Threaded rod supplied as standard on HL050 thru HL225 sizes.)

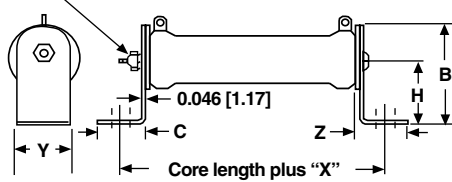

BRACKET TYPE	X	Y	Z	H	MOUNTING SLOT	C	B
101	1.063 [26.99]	0.500 [12.70]	0.859 [21.83]	1.000 [25.40]	0.219 x 0.438 [5.56 x 11.11]	0.750 [19.05]	1.375 [34.93]
102	1.063 [26.99]	0.750 [19.05]	0.859 [21.83]	1.250 [31.75]	0.219 x 0.438 [5.56 x 11.11]	0.750 [19.05]	1.750 [44.45]
103	1.063 [26.99]	1.250 [31.75]	1.000 [25.40]	1.500 [38.10]	0.281 x 0.563 [7.14 x 14.29]	0.875 [22.23]	2.125 [53.98]

### Push-In

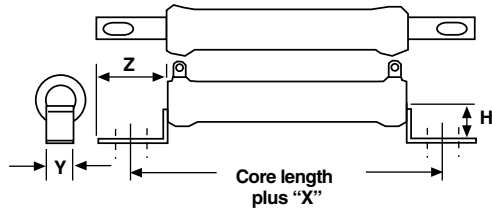

BRACKET TYPE	X	H	Y	Z	HOLE (Dia.)
203	0.625 [15.88]	0.672 [17.07]	0.250 [6.35]	0.469 [11.91]	0.161 [4.09]
204	0.375 [9.53]	0.281 [7.14]	0.250 [6.35]	0.344 [8.73]	0.144 [3.66]
205	0.813 [20.64]	1.391 [35.32]	0.500 [12.70]	0.688 [17.46]	0.196 x 0.260 [4.98 x 6.60]
206	0.719 [18.26]	0.969 [24.61]	0.375 [9.53]	0.625 [15.88]	0.196 x 0.260 [4.98 x 6.60]

### Vertical Thru-Bolt

(Threaded rod supplied as standard on HL050 thru HL225 sizes.)

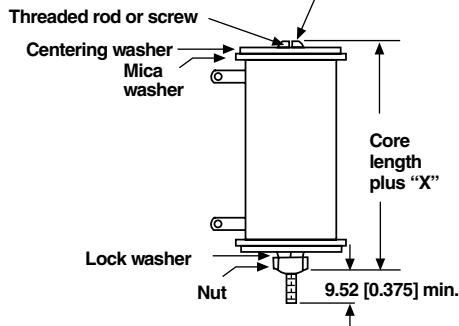

BRACKET TYPE	X (Approximate)	THREAD
301	0.438 [11.11]	8-32
303	0.500 [12.70]	10-32

TECHNICAL SPECIFICATIONS		
PARAMETER	UNIT	HL, NHL RESISTOR CHARACTERISTICS
Temperature Coefficient	ppm/°C	± 90 for 0.1 Ω to 0.99 Ω; ± 50 for 1 Ω to 9.9 Ω; ± 30 for 10 Ω and above
Dielectric Withstanding Voltage	V <sub>AC</sub>	1000, from terminal to mounting hardware
Short Time Overload	-	10 × rated power for 5 s
Maximum Working Voltage	V	(P × R) <sup>1/2</sup>
Insulation Resistance	Ω	1000 MΩ minimum dry, 100 MΩ minimum after moisture test
Operating Temperature Range	°C	- 55 to + 350



**MATERIAL SPECIFICATIONS**

**Element:** Copper-nickel alloy of nickel-chrome alloy, depending on resistance value

**Core:** Ceramic, steatite

**Coating:** Special high temperature silicone

**Standard Terminals:** Model "Z" terminals are tinned steel

**Terminal Bands:** Steel

**Part Marking:** DALE, model, wattage, value, tolerance, date code

**NHL NON-INDUCTIVE**

Models of equivalent physical and electrical specifications are available with non-inductive (Aryton-Perry) winding. They are identified by adding the letter N to the front of the HL type designation (NHL-225 for example). For NHL models maximum resistance values are lower, see STANDARD ELECTRICAL SPECIFICATIONS table.

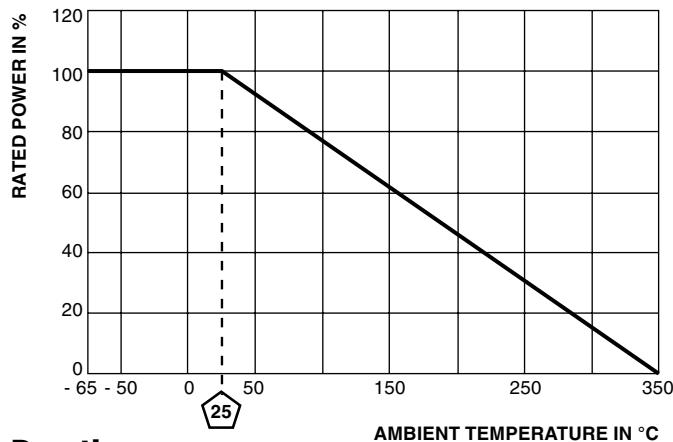

**Derating**

PERFORMANCE		
TEST	CONDITIONS OF TEST	TEST LIMITS
Thermal Shock	Rated power applied until thermally stable, then a minimum of 15 min at - 55 °C	± (2.0 % + 0.05 Ω) ΔR
Short Time Overload	10 x rated power for 5 s	± (2.0 % + 0.05 Ω) ΔR
Dielectric Withstanding Voltage	1000 V <sub>rms</sub> , 1 min	± (0.1 % + 0.05 Ω) ΔR
Low Temperature Storage	- 55 °C for 24 h	± (2.0 % + 0.05 Ω) ΔR
High Temperature Exposure	250 h at + 350 °C	± (2.0 % + 0.05 Ω) ΔR
Moisture Resistance	MIL-STD-202 Method 106, 7b not applicable	± (2.0 % + 0.05 Ω) ΔR
Shock, Specified Pulse	MIL-STD-202 Method 213, 100 g's for 6 ms, 10 shocks	± (0.2 % + 0.05 Ω) ΔR
Vibration, High Frequency	Frequency varied 10 to 2000 Hz, 20 g peak, 2 directions 6 h each	± (0.2 % + 0.05 Ω) ΔR
Load Life	1000 h at rated power, + 25 °C, 1.5 h "ON", 0.5 h "OFF"	± (3.0 % + 0.05 Ω) ΔR



## Disclaimer

All product specifications and data are subject to change without notice.

Vishay Intertechnology, Inc., its affiliates, agents, and employees, and all persons acting on its or their behalf (collectively, "Vishay"), disclaim any and all liability for any errors, inaccuracies or incompleteness contained herein or in any other disclosure relating to any product.

Vishay disclaims any and all liability arising out of the use or application of any product described herein or of any information provided herein to the maximum extent permitted by law. The product specifications do not expand or otherwise modify Vishay's terms and conditions of purchase, including but not limited to the warranty expressed therein, which apply to these products.

No license, express or implied, by estoppel or otherwise, to any intellectual property rights is granted by this document or by any conduct of Vishay.

The products shown herein are not designed for use in medical, life-saving, or life-sustaining applications unless otherwise expressly indicated. Customers using or selling Vishay products not expressly indicated for use in such applications do so entirely at their own risk and agree to fully indemnify Vishay for any damages arising or resulting from such use or sale. Please contact authorized Vishay personnel to obtain written terms and conditions regarding products designed for such applications.

Product names and markings noted herein may be trademarks of their respective owners.