

Thick Film Chip Resistors

NRC Series

FEATURES

- EIA STANDARD SIZING 01005(1/32W), 0201(1/20W), 0402(1/16W), 0603(1/10W), 0805(1/8W), 1206(1/4W), 1210(1/3W), 2010(3/4W) AND 2512(1W)
- METAL GLAZED THICK FILM ON HIGH PURITY ALUMINA SUBSTRATE (CERMET) PROVIDES UNIFORM QUALITY AND HIGH RELIABILITY
- DOUBLE GLASS OVERCOAT ASSURES STRONG MECHANICAL CONSTRUCTION AND LONG LIFE, NICKEL BARRIER PREVENTS LEACHING
- BOTH FLOW SOLDER AND REFLOW SOLDERING ARE APPLICABLE
- ZERO OHM (JUMPER) CHIP AND TRIMMABLE TYPE ARE AVAILABLE *4

NEW
01005
Case Sizes



| Type | EIA Size | Power Rating at 70°C | Max.*1 Working Voltage | Max.*2 Overload Voltage | Resistance Tolerance (Code) | Temperature Coefficient (ppm/°C) | Resistance Range (Ω) | Resistance Value | Operating Temperature Range (°C) |
|----------|----------|---|------------------------|-------------------------|---|----------------------------------|---------------------------|------------------|----------------------------------|
| NRC01 | 01005 | 1/32 (0.031) W | 15V | 30V | ±1% (F) | ±300 | 10 ~ 91 | E-96 | -55 ~ +125 |
| | | | | | ±1% (F) | ±200 | 100 ~ 1.62M | E-96 | |
| | | | | | ±5% (J) | +600/-200 | 1.0 ~ 9.1 | E-24 | |
| | | | | | ±5% (J) | ±300 | 10 ~ 91 | E-24 | |
| NRC02 | 0201 | 1/20 (0.05) W | 25V | 50V | ±1% (F) | ±250 | 10 ~ 1M | E-24 | -55 ~ +125 |
| | | | | | ±5% (J) | ±200 | 10 ~ 10M | E-24 | |
| | | | | | ±10% (K) | | | E-12 | |
| NRC04 | 0402 | 1/16 (0.063) W | 50V | 100V | ±1% (F) | +500/-200 | 1.0 ~ 9.96 | E-96 | -55 ~ +155 |
| | | | | | ±1% (F) | ±100 | 10 ~ 1M | E-96 | |
| | | | | | ±1% (F) | ±300 | 1.02M ~ 10M | E-96 | |
| | | | | | ±5% (J) | ±200 | 10 ~ 1M | E-24 | |
| | | | | | ±5% (J) | ±350 | 1.0 ~ 9.1 & 1.1M ~ 10M *3 | E-24 | |
| NRC06 | 0603 | 1/10 (0.10) W | 50V | 100V | ±1% (F) | ±400 | 1.0 ~ 9.96 | E-96 | -55 ~ +155 |
| | | | | | ±1% (F) | ±100 | 33.2 ~ 1M | E-96 | |
| | | | | | ±1% (F) | ±200 | 10 ~ 32.4 & 1.1M ~ 10M *3 | E-96 | |
| | | | | | ±5% (J) | ±200 | 10 ~ 1M | E-24 | |
| | | | | | ±5% (J) | ±350 | 1.0 ~ 9.1 & 1.1M ~ 10M *3 | E-24 | |
| NRC10 | 0805 | 1/8 (0.125) W | 150V | 300V | ±1% (F) | ±400 | 1.0 ~ 9.96 | E-96 | -55 ~ +175 |
| | | | | | ±1% (F) | ±100 | 33.2 ~ 1M | E-96 | |
| | | | | | ±1% (F) | ±200 | 10 ~ 32.4 & 1.1M ~ 10M *3 | E-96 | |
| | | | | | ±5% (J) | ±200 | 10 ~ 1M | E-24 | |
| | | | | | ±5% (J) | ±350 | 1.0 ~ 9.1 & 1.1M ~ 10M *3 | E-24 | |
| NRC12 | 1206 | 1/4 (0.250) W | 200V | 400V | ±1% (F) | ±400 | 1.0 ~ 9.96 | E-96 | -55 ~ +175 |
| | | | | | ±1% (F) | ±100 | 33.2 ~ 1M | E-96 | |
| | | | | | ±1% (F) | ±200 | 10 ~ 32.4 & 1.1M ~ 10M *3 | E-96 | |
| | | | | | ±5% (J) | ±200 | 10 ~ 1M | E-24 | |
| | | | | | ±5% (J) | ±350 | 1.0 ~ 9.1 & 1.1M ~ 10M *3 | E-24 | |
| NRC25 | 1210 | 1/3 (0.33) W | 200V | 400V | ±1% (F) | ±100 | 10 ~ 1M | E-96 | -55 ~ +175 |
| | | | | | ±5% (J) | ±200 | | E-24 | |
| | | | | | ±5% (J) | ±350 | | E-24 | |
| NRC50 | 2010 | 3/4 (0.75) W | 200V | 400V | ±1% (F) | ±100 | 10 ~ 1M | E-96 | -55 ~ +175 |
| | | | | | ±5% (J) | ±250 | | E-24 | |
| | | | | | ±5% (J) | ±350 | | E-24 | |
| NRC100 | 2512 | 1W | 250V | 500V | ±1% (F) | ±100 | 10 ~ 1M | E-96 | -55 ~ +175 |
| | | | | | ±5% (J) | ±250 | | E-24 | |
| | | | | | ±5% (J) | ±350 | | E-24 | |
| NRC01ZO | 01005 | Zero Ohm Jumper | | | Rated Current 0.5A (0.05Ω max. DC Resistance) | | | | -55 ~ +125 |
| NRC02ZO | 0201 | | | | Rated Current 0.5A (0.05Ω max. DC Resistance) | | | | |
| NRC04ZO | 0402 | | | | Rated Current 1.0A (0.05Ω max. DC Resistance) | | | | |
| NRC06ZO | 0603 | | | | Rated Current 1.0A (0.05Ω max. DC Resistance) | | | | |
| NRC10ZO | 0805 | | | | Rated Current 2.0A (0.05Ω max. DC Resistance) | | | | -55 ~ +175 |
| NRC12ZO | 1206 | | | | Rated Current 2.0A (0.05Ω max. DC Resistance) | | | | |
| NRC25ZO | 1210 | | | | Rated Current 2.0A (0.05Ω max. DC Resistance) | | | | |
| NRC50ZO | 2010 | | | | Rated Current 2.0A (0.05Ω max. DC Resistance) | | | | |
| NRC100ZO | 2512 | Rated Current 2.0A (0.05Ω max. DC Resistance) | | | | | | | |



Note *1 - Maximum allowable continuous Working Voltage for all resistors is the lower of the two values: "Maximum Working Voltage" as specified above (or)

$$\sqrt{\text{Power rating (Watts)} \times \text{Resistance (Ohms)}}$$

Note *2 - Maximum allowable Overload voltage is two times the Maximum Working Voltage (see Note *1 above).

Note *3 - Made to order. Contact NIC for leadtime.

Note *4 - Please contact NIC for availability of laser trimmable versions of 0805 and 1206 sizes parts.

Note *5 - Please note, NIC's NRC series products are capable of meeting the following specifications: JIS-C 5202, EIAJ RC-2690, EIA575, EIA PDP-100, MIL-R-5542D and UL94V-0.

Power Derating Curve: For operation above 70°C, power rating must be derated according to the following chart:



DIMENSIONS (mm)

| Type | Power Rating | EIA Size | L | W | H | T | t | |
|----------|--------------|----------|----------------|----------------|-------------|-------------|-------------|--|
| NRC01 | 1/32W | 01005 | 0.40 ± 0.02 | 0.20 ± 0.02 | 0.13 ± 0.02 | 0.10 ± 0.03 | 0.10 ± 0.03 | |
| NRC02 | 1/20W | 0201 | 0.6 ± 0.03 | 0.3 ± 0.03 | 0.25 ± 0.05 | 0.1 ± 0.05 | 0.15 ± 0.05 | |
| NRC04 | 1/16W | 0402 | 1.0 +0.1/-0.05 | 0.5 +0.1/-0.05 | 0.3 ± 0.05 | 0.2 ± 0.1 | 0.25 ± 0.1 | |
| NRC06 | 1/10W | 0603 | 1.6 ± 0.15 | 0.8 ± 0.15 | 0.45 ± 0.1 | 0.3 ± 0.15 | 0.3 ± 0.15 | |
| NRC10 | 1/8W | 0805 | 2.0 ± 0.20 | 1.25 ± 0.10 | 0.5 ± 0.10 | 0.35 ± 0.20 | 0.35 ± 0.15 | |
| NRC12 | 1/4W | 1206 | 3.1 ± 0.15 | 1.55 ± 0.15 | 0.55 ± 0.10 | 0.45 ± 0.20 | 0.35 ± 0.15 | |
| NRC25 | 1/3W | 1210 | 3.1 ± 0.15 | 2.50 ± 0.20 | 0.55 ± 0.10 | 0.50 ± 0.20 | 0.50 ± 0.25 | |
| NRC50 | 3/4W | 2010 | 5.0 ± 0.15 | 2.50 ± 0.15 | 0.55 ± 0.10 | 1.00 ± 0.20 | 0.50 ± 0.25 | |
| NRC100 | 1W | 2512 | 6.4 ± 0.15 | 3.20 ± 0.15 | 0.55 ± 0.10 | 1.30 ± 0.20 | 0.60 ± 0.30 | |
| NRC01ZO | JUMPER | 01005 | Same as NRC01 | | | | | |
| NRC02ZO | JUMPER | 0201 | Same as NRC02 | | | | | |
| NRC04ZO | JUMPER | 0402 | Same as NRC04 | | | | | |
| NRC06ZO | JUMPER | 0603 | Same as NRC06 | | | | | |
| NRC10ZO | JUMPER | 0805 | Same as NRC10 | | | | | |
| NRC12ZO | JUMPER | 1206 | Same as NRC12 | | | | | |
| NRC25ZO | JUMPER | 1210 | Same as NRC25 | | | | | |
| NRC50ZO | JUMPER | 2010 | Same as NRC50 | | | | | |
| NRC100ZO | JUMPER | 2512 | Same as NRC100 | | | | | |



CONSTRUCTION

NRC01 (01005)

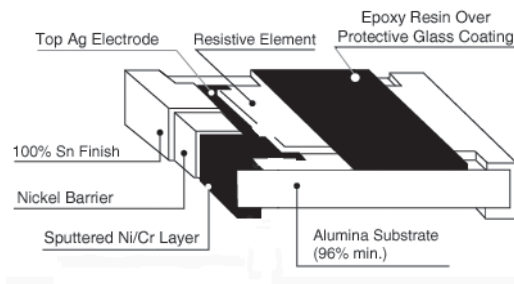

CONSTRUCTION

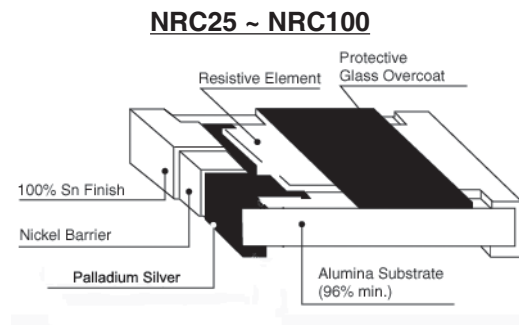
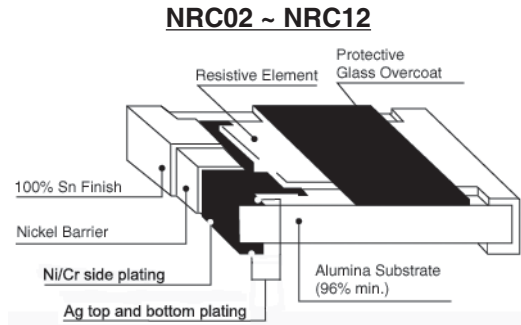

PART NUMBER SYSTEM (E-24 VALUES)

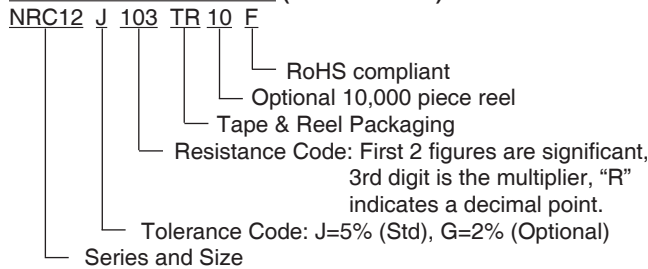

Examples of Resistance Code: 4R7 = 4.7 ohms 103 = 10K ohms
 100 = 10 ohms 104 = 100K ohms
 101 = 100 ohms 105 = 1 meg ohms
 102 = 1K ohms 106 = 10meg ohms

PART NUMBER SYSTEM (E-96 VALUES)

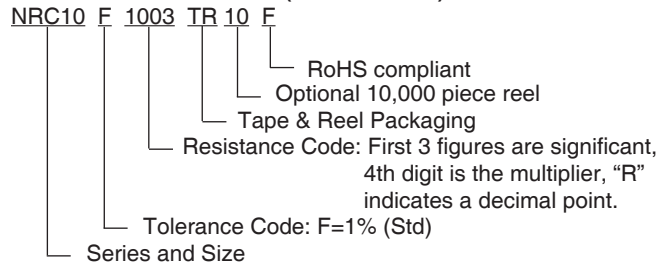

Examples of Resistance Code: 10R0 = 10 ohms 1004 = 1meg ohms
 47R5 = 47.5 ohms 1050 = 105 ohms
 1000 = 100 ohms 1501 = 1.5K ohms
 1001 = 1K ohms 1052 = 10.5K ohms
 1002 = 10K ohms 1153 = 115K ohms
 1003 = 100K ohms 1214 = 1.21meg ohms

Marking (No marking on 0201 and 0402 size).

1. For **E-12 & E-24** Series (G + ±2%, J = ±5% (STD) Tolerance) In 0603, 0805, 1206, 1210, 2010 and 2512 sizes:

3 DIGIT SYSTEM - First two digits are significant and third digit is multiplier, "R" indicates decimal on values under 10 ohms.

Examples: R10 = .10 ohms 1R0 = 1.0 ohms 102 = 1k ohms 470 = 47 ohms
 103 = 10k ohms 101 = 100 ohms 104 = 100k ohms 105 = 1 megohms

2. For **E-96** Series (F% = 1% Tolerance) in 0805, 1206 and 1210 sizes:

4 DIGIT SYSTEM - First 3 digits are significant and fourth digit is multiplier, "R" indicates decimal on values under 100 ohms.

Examples: 0R10 = .10 ohms 1R00 = 1.0 ohms 10R0 = 10 ohms 1003 = 100 kohms
 1000 = 100 ohms 1004 = 1 megohms 1001 = 1k ohms
 1052 = 10.5k ohms 1002 = 10k ohms 2213 = 221k ohms

3. For **E-96** Series (F = 1% Tolerance) in 0603 size

3 DIGIT SYSTEM (Due to space restrictions)



STANDARD E-12, E-24, E-96 VALUES AND 0603 RESISTANCE CODES

| E-12 | | E-24 | | E-96 | | | | | | | |
|-------|--|-------|--|-------|------|-------|------|-------|------|-------|------|
| Value | | Value | | Value | Code | Value | Code | Value | Code | Value | Code |
| 10 | | 100 | | 100 | 01 | 102 | 02 | 105 | 03 | 107 | 04 |
| 12 | | 110 | | 110 | 05 | 113 | 06 | 115 | 07 | 118 | 08 |
| 15 | | 120 | | 121 | 09 | 124 | 10 | 127 | 11 | 130 | 12 |
| 18 | | 130 | | 133 | 13 | 137 | 14 | 140 | 15 | 143 | 16 |
| 22 | | 150 | | 147 | 17 | 150 | 18 | 154 | 19 | 158 | 20 |
| 27 | | 160 | | 162 | 21 | 165 | 22 | 169 | 23 | 174 | 24 |
| 33 | | 180 | | 178 | 25 | 182 | 26 | 187 | 27 | 191 | 28 |
| 39 | | 200 | | 196 | 29 | 200 | 30 | 205 | 31 | 210 | 32 |
| 47 | | 220 | | 215 | 33 | 221 | 34 | 226 | 35 | 232 | 36 |
| 56 | | 240 | | 237 | 37 | 243 | 38 | 249 | 39 | 255 | 40 |
| 68 | | 270 | | 261 | 41 | 267 | 42 | 274 | 43 | 280 | 44 |
| 82 | | 300 | | 287 | 45 | 294 | 46 | 301 | 47 | 309 | 48 |
| 91 | | 330 | | 316 | 49 | 324 | 50 | 332 | 51 | 340 | 52 |
| | | 360 | | 348 | 53 | 357 | 54 | 365 | 55 | 374 | 56 |
| | | 390 | | 383 | 57 | 392 | 58 | 402 | 59 | 412 | 60 |
| | | 430 | | 422 | 61 | 432 | 62 | 442 | 63 | 453 | 64 |
| | | 470 | | 464 | 65 | 475 | 66 | 487 | 67 | 499 | 68 |
| | | 510 | | 511 | 69 | 523 | 70 | 536 | 71 | 549 | 72 |
| | | 560 | | 562 | 73 | 576 | 74 | 590 | 75 | 604 | 76 |
| | | 620 | | 619 | 77 | 634 | 78 | 649 | 79 | 665 | 80 |
| | | 680 | | 681 | 81 | 698 | 82 | 715 | 83 | 732 | 84 |
| | | 750 | | 750 | 85 | 768 | 86 | 787 | 87 | 806 | 88 |
| | | 820 | | 825 | 89 | 845 | 90 | 866 | 91 | 887 | 92 |
| | | 910 | | 909 | 93 | 931 | 94 | 953 | 95 | 976 | 96 |

MULTIPLIER CODE

| Code | A | B,b | C | D,d | E | F | G | H | X | Y | Z |
|------------|-----------------|-----------------|-----------------|-----------------|-----------------|-----------------|-----------------|-----------------|------------------|------------------|------------------|
| Multiplier | 10 ⁰ | 10 ¹ | 10 ² | 10 ³ | 10 ⁴ | 10 ⁵ | 10 ⁶ | 10 ⁷ | 10 ⁻¹ | 10 ⁻² | 10 ⁻³ |

CODING FORMULA



Example: $10.2k\Omega = \frac{102}{02} \times 10^2 \Omega = 02C$

$33.2 \Omega = \frac{332}{51} \times 10^{-1} = 51X$

MARKING EXAMPLES

- 10Ω = 01X
- 7.5kΩ = 85B or 85b
- 150kΩ = 18D or 18d
- 1 MegΩ = 01E

TAPING SPECIFICATIONS

(1) Availability

| Type | Power Rating | EIA Size | Carrier Tape | | | Qty per 7" Reel | Qty per 10" Reel |
|---------|--------------|----------|--------------|----------|------------|-----------------|------------------|
| | | | Fig. | Material | Width (mm) | | |
| NRC01 | 1/32W | 01005 | A | Paper | 8 | 20,000 | N/A |
| NRC02 | 1/20W | 0201 | A | Paper | 8 | 10,000 | N/A |
| NRC04 | 1/16W | 0402 | A | Paper | 8 | 10,000 | N/A |
| NRC06 | 1/10W | 0603 | A | Paper | 8 | 5,000 | 10,000 |
| NRC10 | 1/8W | 0805 | A | Paper | 8 | 5,000 | 10,000 |
| NRC12 | 1/4W | 1206 | A | Paper | 8 | 5,000 | 10,000 |
| NRC25 | 1/3W | 1210 | B | Plastic | 12 | 4,000 | N/A |
| NRC04ZO | Jumper | 0402 | A | Paper | 8 | 10,000 | N/A |
| NRC06ZO | Jumper | 0603 | A | Paper | 8 | 5,000 | 10,000 |
| NRC10ZO | Jumper | 0805 | A | Paper | 8 | 5,000 | 10,000 |
| NRC12ZO | Jumper | 1206 | A | Paper | 8 | 5,000 | 10,000 |
| NRC25ZO | Jumper | 1210 | B | Plastic | 12 | 4,000 | N/A |



(2) PAPER TAPE DIMENSIONS (mm)

FIG. A

| Type | EIA Size | A | B | D | E | F | P ₀ | P ₁ | P ₂ | P ₃ | T ₁ | T ₂ | W |
|--------|----------|--------------|-------------|--------------|---------------|---------------|----------------|----------------|----------------|----------------|----------------|----------------|--------------|
| NRC01* | 01005 | 0.25 ± 0.05 | 0.45 ± 0.05 | 1.5 + 0.1 | 1.75 ± 0.1 | 3.5 ± 0.05 | 4.0 ± 0.1 | 2.0 ± 0.05 | N/A | 2.0 ± 0.05 | 0.39 max. | 0.31 ± 0.03 | 8.0 ± 0.2 |
| NRC02* | 0201 | 0.41 ± 0.1 | 0.71 ± 0.1 | | | | | 2.0 ± 0.1 | | 2.0 ± 0.1 | | | |
| NRC04* | 0402 | 0.65 ± 0.1 | 1.15 ± 0.1 | | | | | 2.0 ± 0.05 | | 2.0 ± 0.05 | | | |
| NRC06* | 0603 | 1.135 ± 0.05 | 1.95 ± 0.05 | | | | | N/A | 4.0 ± 0.05 | 4.0 ± 0.05 | 1.1 max. | 1.0 max. | |
| NRC10* | 0805 | 1.65 ± 0.2 | 2.4 ± 0.2 | | | | | | | | | | |
| NRC12* | 1206 | 2.0 ± 0.2 | 3.6 ± 0.2 | | | | | | | | | | |

* Same for JUMPER (ZO) types.

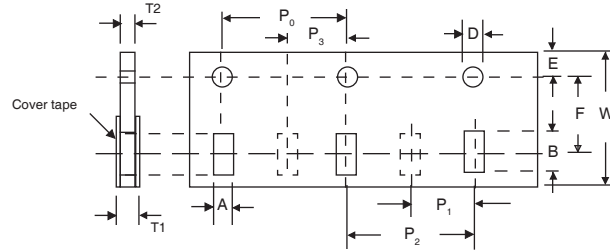

(3) EMBOSSED PLASTIC TAPE SPECIFICATION

FIG. B.

| Type | EIA Size | A | B | D | E | F | P ₀ | P ₁ | W | Qty per 7" Reel |
|---------|----------|-----------|-----------|-----------|-----------|-------------|----------------|----------------|------------|-----------------|
| NRC25* | 1210 | 2.9 ± 0.2 | 3.6 ± 0.2 | 1.5 ± 0.1 | 1.5 ± 0.1 | 5.65 ± 0.05 | 4.0 ± 0.1 | 4.0 ± 0.05 | 12.0 ± 0.1 | 4,000 |
| NRC50* | 2010 | 2.9 ± 0.1 | 5.4 ± 0.1 | | | | | | | 4,000 |
| NRC100* | 2512 | 3.6 ± 0.1 | 6.9 ± 0.1 | | | | | | | 4,000 |

* Same for JUMPER (ZO) types.

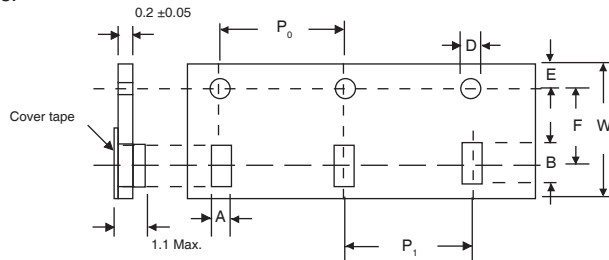

(4) REEL SPECIFICATIONS

FIG. C.

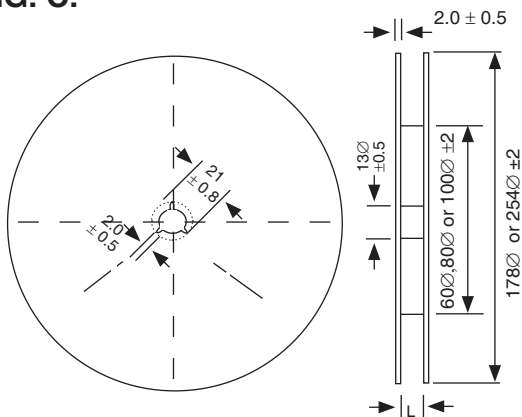

1. Leader tape : Approximately 250 m/m (160mm for 0201 case size) leader shall be provided at each end of the tape.

2. Accumulative tolerance of feeding hole and chip pocket shall not exceed 0.2mm over 10 pitches.

| Type | EIA Size | L (mm) |
|---------|----------|------------|
| NRC01* | 01005 | 9.0 ± 0.3 |
| NRC02* | 0201 | 10.0 ± 1.5 |
| NRC04* | 0402 | 10.0 ± 1.5 |
| NRC06* | 0603 | 10.0 ± 1.5 |
| NRC10* | 0805 | 10.0 ± 1.5 |
| NRC12* | 1206 | 10.0 ± 1.5 |
| NRC25 | 1210 | 10.0 ± 1.5 |
| NRC50 | 2010 | 13.5 ± 1.5 |
| NRC100* | 2512 | 13.5 ± 1.5 |

* Same for JUMPER (ZO) types.

