

Features

- Standard E.I.A. package compatible with automatic placement equipment
- Compliant leads to reduce solder joint fatiguing
- Tape and reel packaging standard
- Marking on contrasting background for permanent identification
- Standard electrical schematics: isolated, bussed, dual terminator
- Custom circuits are available
- Now available with improved tolerance to $\pm 0.5\%$

4400P Series - Thick Film Surface Mounted Wide Body

Product Characteristics

Resistance Range10 ohms to 2.2 megohms
 Maximum Operating Voltage.....50 V
 Temperature Coefficient of Resistance
 50 ohms and above..... ± 100 ppm/ $^{\circ}\text{C}$
 below 50 ohms..... ± 250 ppm/ $^{\circ}\text{C}$
 TCR Tracking
50 ppm/ $^{\circ}\text{C}$ max.; equal values
 Operating Temperature
-55 $^{\circ}\text{C}$ to +125 $^{\circ}\text{C}$
 Insulation Resistance
10,000 megohms min.
 Dielectric Withstanding Voltage
200 VRMS
 Lead Solderability
Meet requirements of MIL-STD-202
 Method 208

Environmental Characteristics

TESTS PER MIL-STD-202..... ΔR MAX.
 Short Time Overload..... $\pm 0.25\%$
 Load Life $\pm 1.00\%$
 Moisture Resistance $\pm 0.50\%$
 Resistance to Soldering Heat $\pm 0.25\%$
 Thermal Shock..... $\pm 0.25\%$

Physical Characteristics

Flammability Conforms to UL94V-0
 Lead Frame Material
Copper, solder coated
 Body MaterialNovolac epoxy

How To Order

44 20 P - 1 - 103

Model _____
 (44 = SMD SOL Pkg)
 Number of Pins _____
 Electrical Configuration _____
 • 1 or 4 = Isolated*
 • 2 = Bussed*
 • 3 = Dual Terminator*
 Resistance Code _____
 • First 2 digits are significant
 • Third digit represents the number of zeros to follow.
 Resistance Tolerance _____
 • Blank = $\pm 2\%$ (see "Resistance Tolerance" on next page for resistance range)
 • F = $\pm 1\%$ (100 Ω - 1 M Ω)
 • D = $\pm 0.5\%$ (100 Ω - 1 M Ω)

*For tube packaging, use T01, T02, T03 or T04.
 Consult factory for other available options.

Package Power Temp. Derating Curve

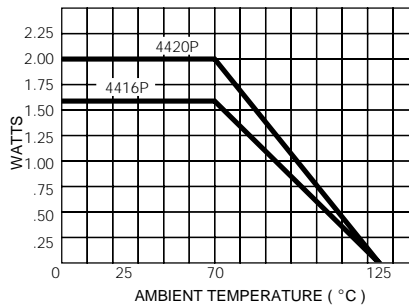

Package Power Rating at 70 $^{\circ}\text{C}$

4420P.....2.00 watts
 4416P.....1.60 watts

Recommended Land Pattern

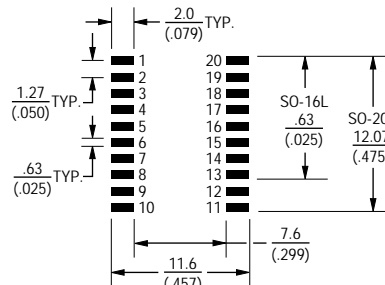

NOTE: Land pattern dimensions are based on design rules established by the Institute for Interconnecting and Packaging Electronic Circuits in IPC-SM-782.

Product Dimensions

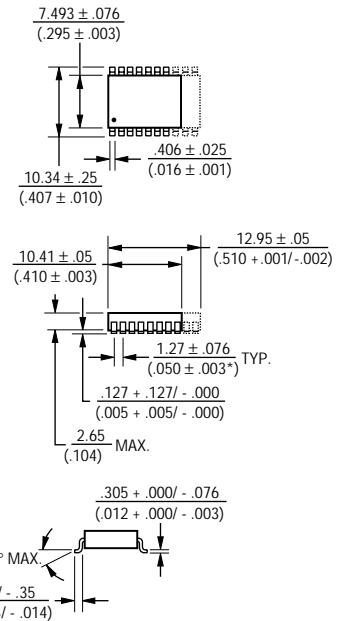

Governing dimensions are in metric. Dimensions in parentheses are inches and are approximate.

*Terminal centerline to centerline measurements made at point of emergence of the lead from the body.

Typical Part Marking

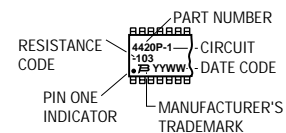

For information on specific applications,
download Bourns' application notes:

- DRAM Applications
- Dual Terminator Resistor Networks
- R/2R Ladder Networks
- SCSI Applications

4400P Series - Thick Film Surface Mounted Wide Body



Isolated Resistors (1 And 4 Circuits)

Model 4416P-1
Model 4420P-1 (Shown)

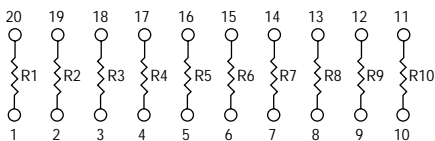

Model 4416P-4
Model 4420P-4 (Shown)

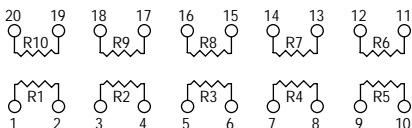

Resistance Tolerance

10 ohms to 49 ohms±1 ohm
50 ohms to 2.2 megohms.....±2 %*

Power Rating per Resistor

1 Circuit at 70 °C0.160 watt
4 Circuit at 70 °C0.160 watt

Resistor Power Temp. Derating Curve

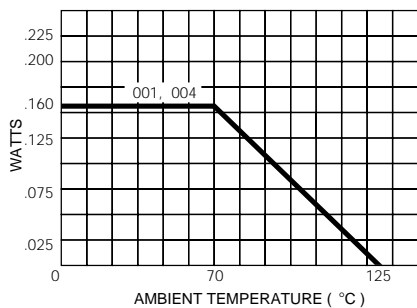

Bussed Resistors (2 Circuit)

Model 4416P-2
Model 4420P-2 (Shown)

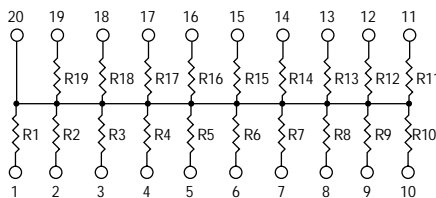

Resistance Tolerance

10 ohms to 49 ohms±1 ohm
50 ohms to 2.2 megohms±2 %*

Power Rating per Resistor

2 Circuit at 70 °C0.160 watt

Resistor Power Temp. Derating Curve

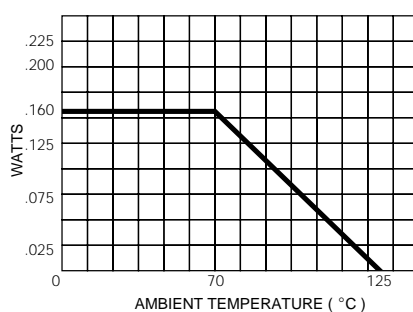

Dual Terminator (3 Circuit)

Model 4416P-3
Model 4420P-3 (Shown)

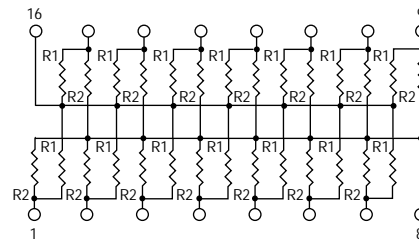

4420P-3 terminates 16 lines,
convenient for a 16-bit computer bus.

Resistance Tolerance

Below 100 ohms±2 ohms
100 ohms to 2.2 megohms±2 %*

Power Rating per Resistor

3 Circuit at 70 °C0.115 watt

Resistor Power Temp. Derating Curve

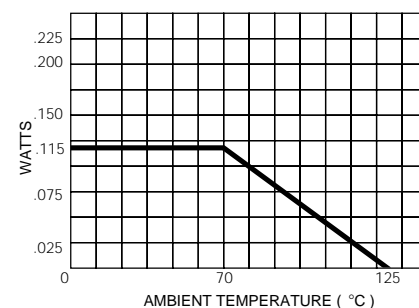

Popular Resistance Values (1, 4, And 2 Circuits)**

Ohms	Code	Ohms	Code	Ohms	Code	Ohms	Code	Ohms	Code
10	100	180	181	1,800	182	15,000	153	120,000	124
22	220	220	221	2,000	202	18,000	183	150,000	154
27	270	270	271	2,200	222	20,000	203	180,000	184
33	330	330	331	2,700	272	22,000	223	220,000	224
39	390	390	391	3,300	332	27,000	273	270,000	274
47	470	470	471	3,900	392	33,000	333	330,000	334
56	560	560	561	4,700	472	39,000	393	390,000	394
68	680	680	681	5,600	562	47,000	473	470,000	474
82	820	820	821	6,800	682	56,000	563	560,000	564
100	101	1,000	102	8,200	822	68,000	683	680,000	684
120	121	1,200	122	10,000	103	82,000	823	820,000	824
150	151	1,500	152	12,000	123	100,000	104	1,000,000	105

Popular Resistance Values (3 Circuit)**

Resistance			
(Ohms)		Code	
R ₁	R ₂	R ₁	R ₂
160	240	161	241
180	390	181	391
220	270	221	271
220	330	221	331
330	390	331	391
330	470	331	471
3,000	6,200	302	622

* ADD "F" AFTER RESISTANCE CODE FOR ±1 % TOLERANCE AVAILABLE FROM 100 Ω THROUGH 1 MΩ, OR ADD "D" AFTER RESISTANCE CODE FOR ±0.5 % TOLERANCE AVAILABLE FROM 100 Ω THROUGH 1 MΩ.

PART NUMBER SUFFIX EXAMPLES: -103 = 10 KΩ, ±2 % -103F = 10 KΩ, ±1 % -103D = 10 KΩ, ±0.5 %

** NON-STANDARD VALUES AVAILABLE, WITHIN RESISTANCE RANGE.