

## Single line IPAD™, EMI filter and ESD protection

### Features

- EMI symmetrical (I/O) low-pass filter
- High efficiency EMI filtering
- Lead-free package
- 400 µm pitch
- Very low PCB space occupation: 0.6 mm<sup>2</sup>
- Very thin package: 0.6 mm
- High reliability offered by monolithic integration
- Reduction of parasitic elements through CSP integration

### Complies with the following standards

- IEC 61000-4-2 level 4 on internal and external pins:
  - 15 kV (air discharge)
  - 8 kV (contact discharge)
- MIL STD 883F - Method 3015.7 Class 3

### Application

- TV analog signal in TV\_OUT interface

### Description

The EMIF01-TV01F3 is a highly integrated array designed to suppress EMI/RFI noise and provide impedance matching for mobile phone and portable applications. The EMIF01-TV01F3 is in a Flip Chip package to offer space saving and high RF performance.

This low pass filter includes ESD protection circuitry which prevents damage to the protected device when subjected to ESD surges up to 15 kV.

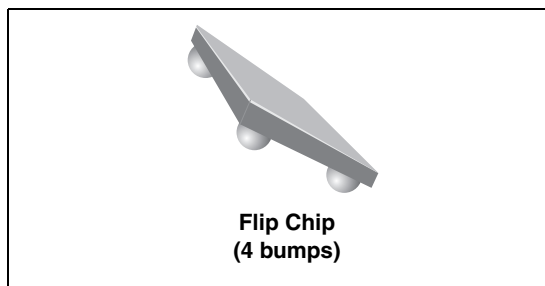

**Figure 1. Pin configuration (bump side)**

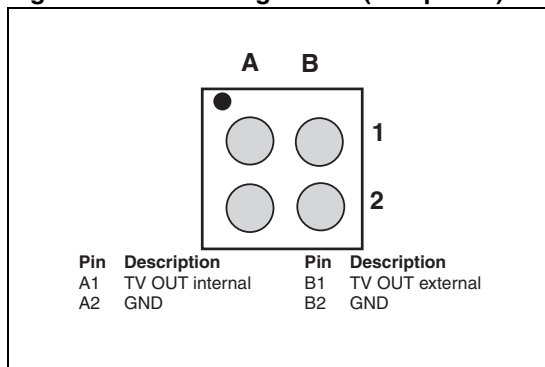

**Figure 2. Device configuration**

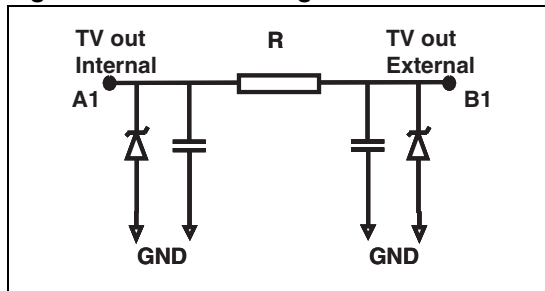

**TM:** IPAD is a trademark of STMicroelectronics.

# 1 Characteristics

**Table 1. Absolute maximum ratings**

Symbol	Parameter and test conditions	Value	Unit
$V_{PP}$	<b>Internal pins (A1) and external pin (B1):</b> ESD discharge IEC61000-4-2, air discharge ESD discharge IEC61000-4-2, contact discharge	15 8	kV
$T_j$	Maximum junction temperature	125	°C
$T_{Op}$	Operating temperature range	-30 to +85	°C
P	Maximum power dissipation	80	°C
$T_{stg}$	Storage temperature range	-55 to 150	°C

**Table 2. Electrical characteristics ( $T_{amb} = 25\text{ °C}$ )**

Symbol	Parameters				
$V_{BR}$	Breakdown voltage				
$I_{RM}$	Leakage current @ $V_{RM}$				
$V_{RM}$	Stand-off voltage				
$V_{CL}$	Clamping voltage				
$R_d$	Dynamic impedance				
$I_{PP}$	Peak pulse current				
$R_{I/O}$	Series resistance between Input & Output				
$C_{line}$	Input capacitance per line				
Symbol	Test conditions				
$V_{BR}$	$I_R = 1\text{ mA}$	6		8	V
$I_{RM}$	$V_{RM} = 3\text{ V}$			0.2	$\mu\text{A}$
R	Tolerance $\pm 5\%$		75		$\Omega$
$C_{line}$	@ 0 V		30	35	pF

**Figure 3. S21 (db) attenuation measurement** **Figure 4. ESD response to IEC 61000-4-2 (+15 kV air discharge)**

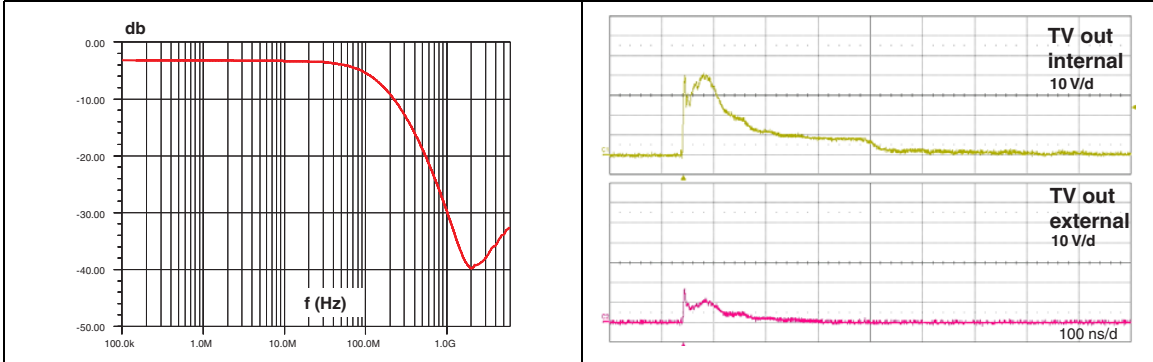

**Figure 5. ESD response to IEC 61000-4-2 (-15 kV air discharge)** **Figure 6. Line capacitance versus applied voltage**

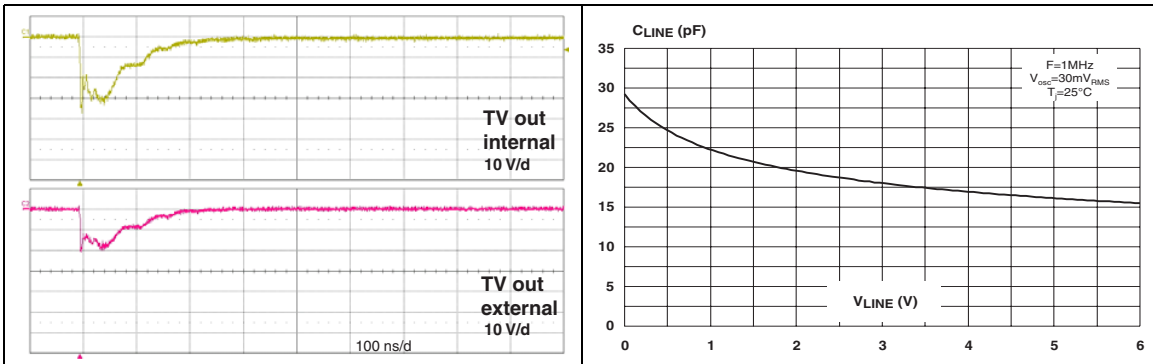

## 2 Application information

Figure 7. Aplac model

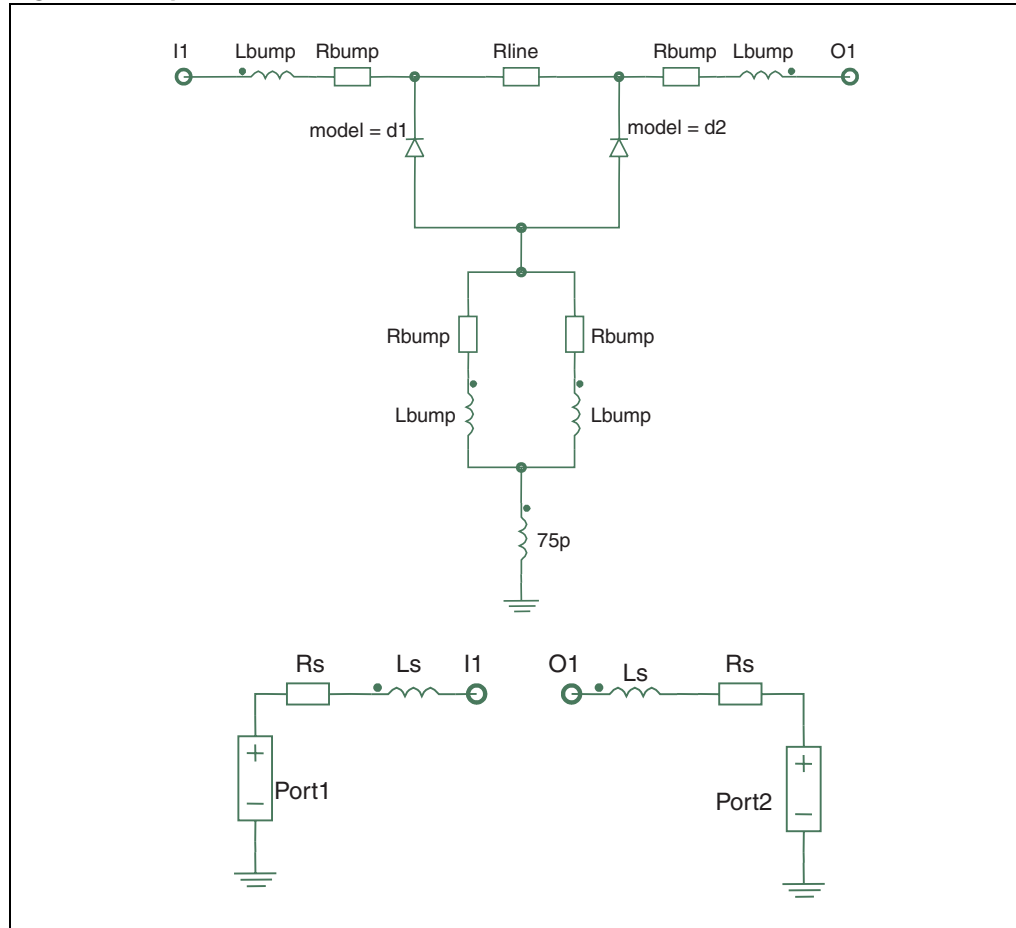
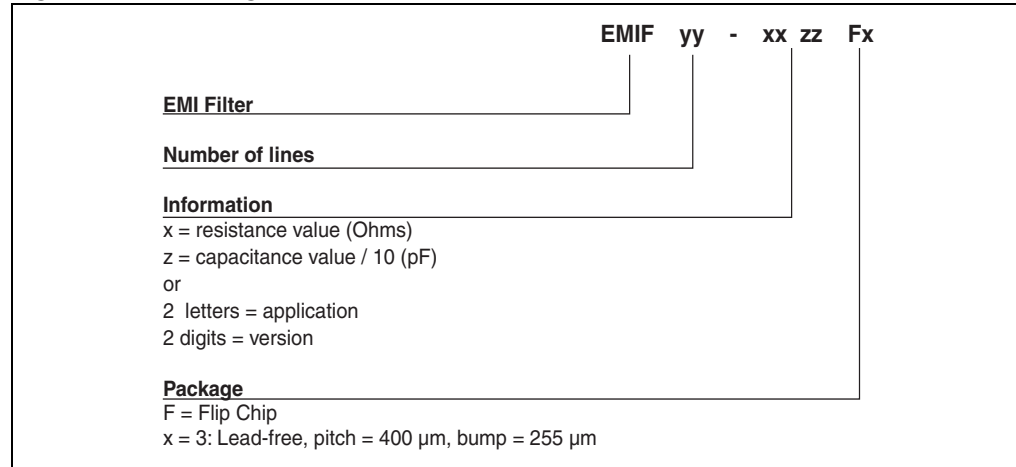

Figure 8. Aplac parameters

Variables	Diode D1	Diode D2
aplacvar Rline 75	BV=7	BV=7
aplacvar C_d1 17.5p	IBV=1m	IBV=1m
aplacvar C_d2 17.5p	CJO=C_d1	CJO=C_d2
aplacvar Ls 950pH	M=0.28	M=0.28
aplacvar Rs 150m	RS=0.48	RS=0.7
aplacvar Lbump96pH	VJ=0.6	VJ=0.6
aplacvar Rbump 20m	TT=100n	TT=100n
aplacvar Lgnd 75pH		

### 3 Ordering information scheme

Figure 9. Ordering information scheme



### 4 Package information

In order to meet environmental requirements, ST offers these devices in ECOPACK<sup>®</sup> packages. These packages have a lead-free second level interconnect. The category of second level interconnect is marked on the inner box label, in compliance with JEDEC Standard JESD97. The maximum ratings related to soldering conditions are also marked on the inner box label. ECOPACK is an ST trademark. ECOPACK specifications are available at [www.st.com](http://www.st.com).

Figure 10. Package dimensions

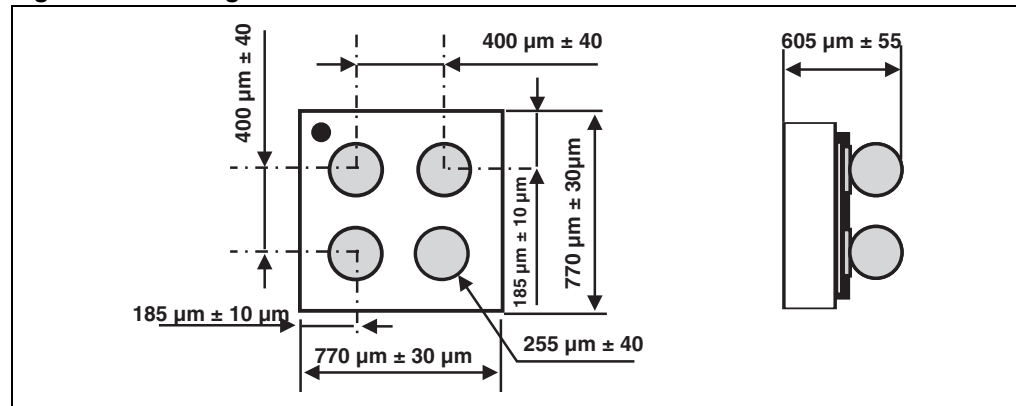

Figure 11. Footprint

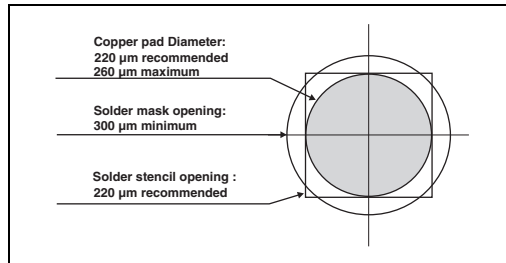

Figure 12. Marking

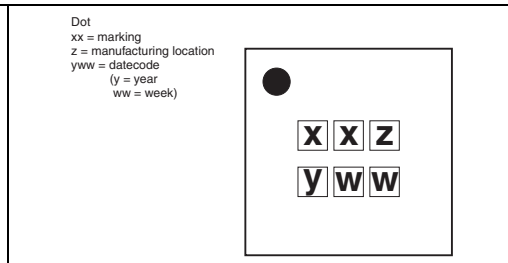
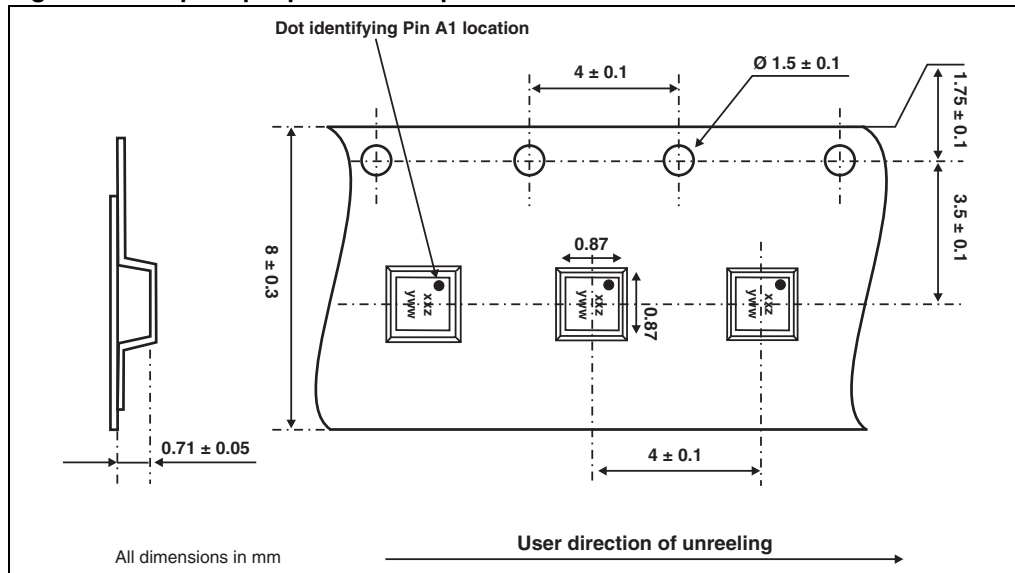

Figure 13. Flip Chip tape and reel specification



Note: More information is available in the application notes:  
 AN2348: “STMicroelectronics 400 micro-metre Flip Chip: Package description and recommendation for use”  
 AN1751: “EMI filters: Recommendations and measurements”

## 5 Ordering information

Table 3. Ordering information

Order code	Marking	Package	Weight	Base qty	Delivery mode
EMIF01-TV01F3	HC	Flip Chip	0.79 mg	5000	Tape and reel 7”

## 6 Revision history

Table 4. Document revision history

Date	Revision	Changes
09-Feb-2006	1	Initial release.
28-Apr-2008	2	Updated ECOPACK statement. Updated <a href="#">Figure 9</a> , <a href="#">Figure 10</a> , and <a href="#">Figure 13</a> . Reformatted to current standards.

**Please Read Carefully:**

Information in this document is provided solely in connection with ST products. STMicroelectronics NV and its subsidiaries ("ST") reserve the right to make changes, corrections, modifications or improvements, to this document, and the products and services described herein at any time, without notice.

All ST products are sold pursuant to ST's terms and conditions of sale.

Purchasers are solely responsible for the choice, selection and use of the ST products and services described herein, and ST assumes no liability whatsoever relating to the choice, selection or use of the ST products and services described herein.

No license, express or implied, by estoppel or otherwise, to any intellectual property rights is granted under this document. If any part of this document refers to any third party products or services it shall not be deemed a license grant by ST for the use of such third party products or services, or any intellectual property contained therein or considered as a warranty covering the use in any manner whatsoever of such third party products or services or any intellectual property contained therein.

**UNLESS OTHERWISE SET FORTH IN ST'S TERMS AND CONDITIONS OF SALE ST DISCLAIMS ANY EXPRESS OR IMPLIED WARRANTY WITH RESPECT TO THE USE AND/OR SALE OF ST PRODUCTS INCLUDING WITHOUT LIMITATION IMPLIED WARRANTIES OF MERCHANTABILITY, FITNESS FOR A PARTICULAR PURPOSE (AND THEIR EQUIVALENTS UNDER THE LAWS OF ANY JURISDICTION), OR INFRINGEMENT OF ANY PATENT, COPYRIGHT OR OTHER INTELLECTUAL PROPERTY RIGHT.**

**UNLESS EXPRESSLY APPROVED IN WRITING BY AN AUTHORIZED REPRESENTATIVE OF ST, ST PRODUCTS ARE NOT DESIGNED, AUTHORIZED OR WARRANTED FOR USE IN MILITARY, AIR CRAFT, SPACE, LIFE SAVING, OR LIFE SUSTAINING APPLICATIONS, NOR IN PRODUCTS OR SYSTEMS, WHERE FAILURE OR MALFUNCTION MAY RESULT IN PERSONAL INJURY, DEATH, OR SEVERE PROPERTY OR ENVIRONMENTAL DAMAGE. ST PRODUCTS WHICH ARE NOT SPECIFIED AS "AUTOMOTIVE GRADE" MAY ONLY BE USED IN AUTOMOTIVE APPLICATIONS AT USER'S OWN RISK.**

Resale of ST products with provisions different from the statements and/or technical features set forth in this document shall immediately void any warranty granted by ST for the ST product or service described herein and shall not create or extend in any manner whatsoever, any liability of ST.

ST and the ST logo are trademarks or registered trademarks of ST in various countries.

Information in this document supersedes and replaces all information previously supplied.

The ST logo is a registered trademark of STMicroelectronics. All other names are the property of their respective owners.

© 2008 STMicroelectronics - All rights reserved

STMicroelectronics group of companies

Australia - Belgium - Brazil - Canada - China - Czech Republic - Finland - France - Germany - Hong Kong - India - Israel - Italy - Japan - Malaysia - Malta - Morocco - Singapore - Spain - Sweden - Switzerland - United Kingdom - United States of America

[www.st.com](http://www.st.com)