

On-Board Type (DC) EMI Suppression Filters (EMIFIL[®])

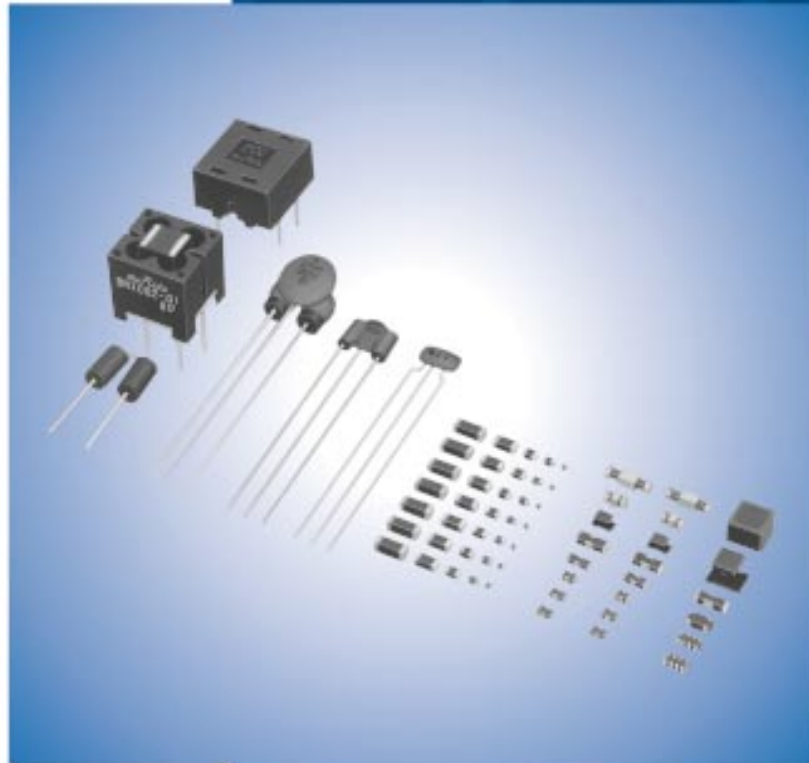

Cat.No.C31E-20

muRata *Innovator
in Electronics*
Murata
Manufacturing Co., Ltd.

for EU RoHS Compliant

- All the products in this catalog comply with EU RoHS.
- EU RoHS is "the European Directive 2002/95/EC on the Restriction of the Use of Certain Hazardous Substances in Electrical and Electronic Equipment".
- For more details, please refer to our website 'Murata's Approach for EU RoHS' (<http://www.murata.com/info/rohs.html>).

CONTENTS

EMIFIL®, EMIGUARD®, "EMIFIL" and "EMIGUARD" in this catalog are the trademarks of Murata Manufacturing Co., Ltd.

Selection Guide of EMI Filters	2	
Product Guide / Effective Frequency Range	4	
Outlines of EMI Suppression Filters (EMIFIL®) for DC Line	7	
1 Chip Ferrite Beads Part Numbering / Impedance Map / BLM Series Line Up	13	1
●BLM02A/03A/15A/18A/21A	21	●BLM18K
●BLM18T	32	●BLM18S
●BLM03B/15B/18B/21B	34	●For GHz Band Noise Suppression BLM15H/15E/18H/18E
●BLM18R/21R	50	●For High-GHz Band Noise Suppression BLM15G/18G
●BLM03P/15P/18P/21P/31P/41P	55	●Array Type BLA2AA/2AB/31A/31B
		85
2 Chip EMIFIL® Part Numbering	92	2
●Capacitor Type NFM18C/21C/3DC/41C	95	●RC Combined Type NFR21G
●Capacitor Array Type NFA31C	99	●RC Combined Array Type NFA31G
●LC Combined Monolithic Type NFL18ST/18SP/21S	100	●For Large Current NFM18P/21P/3DP/31P/41P/55P
●LC Combined Array Type NFA18S/21S	103	●LC Combined Type for Large Current NFE31P/61P
●LC Combined Wire Wound Type NFW31S	106	
3 Chip Common Mode Choke Coils Part Numbering	123	3
●Film Type DLP0NS/11S/31S	124	●Wire Wound Type DLW21S/21H/31S
●Film Type Array DLP2AD/31D	128	●Wire Wound Type for Large Current DLW5AH/5BS/5BT
●Monolithic Type DLM11G/2HG	131	137
4 Block Type EMIFIL®		4
●SMD Type BNX022/023	140	
●Lead Type BNX00□/01□	141	
5 Lead Type EMI Suppression Filters (EMIFIL®)		5
Ferrite Beads Inductors Part Numbering		EMIGUARD® (EMIFIL® with Varistor Function) Part Numbering
●BL01/02/03	145	●VFR3V/VFS6V/VFS9V
Disc Type EMIFIL® Part Numbering		Common Mode Choke Coils Part Numbering
●DS□6/Wide frequency DS□9N/Heavy-duty Type DS□9H	149	●PLT09H
		167
6 Microwave Absorbers Part Numbering	169	6
●EA10/20/21/22/30	170	
△Caution / Notice	173	
Soldering and Mounting	177	
Packaging	191	
Chip EMI Suppression Filter Design Kits	195	
Outlines of Major Noise Regulation Standards	203	
Principles of Noise Suppression by DC EMIFIL®	208	
Murata EMI Filter Selection Simulator	212	

Selection Guide of EMI Filters

Chip Ferrite Beads

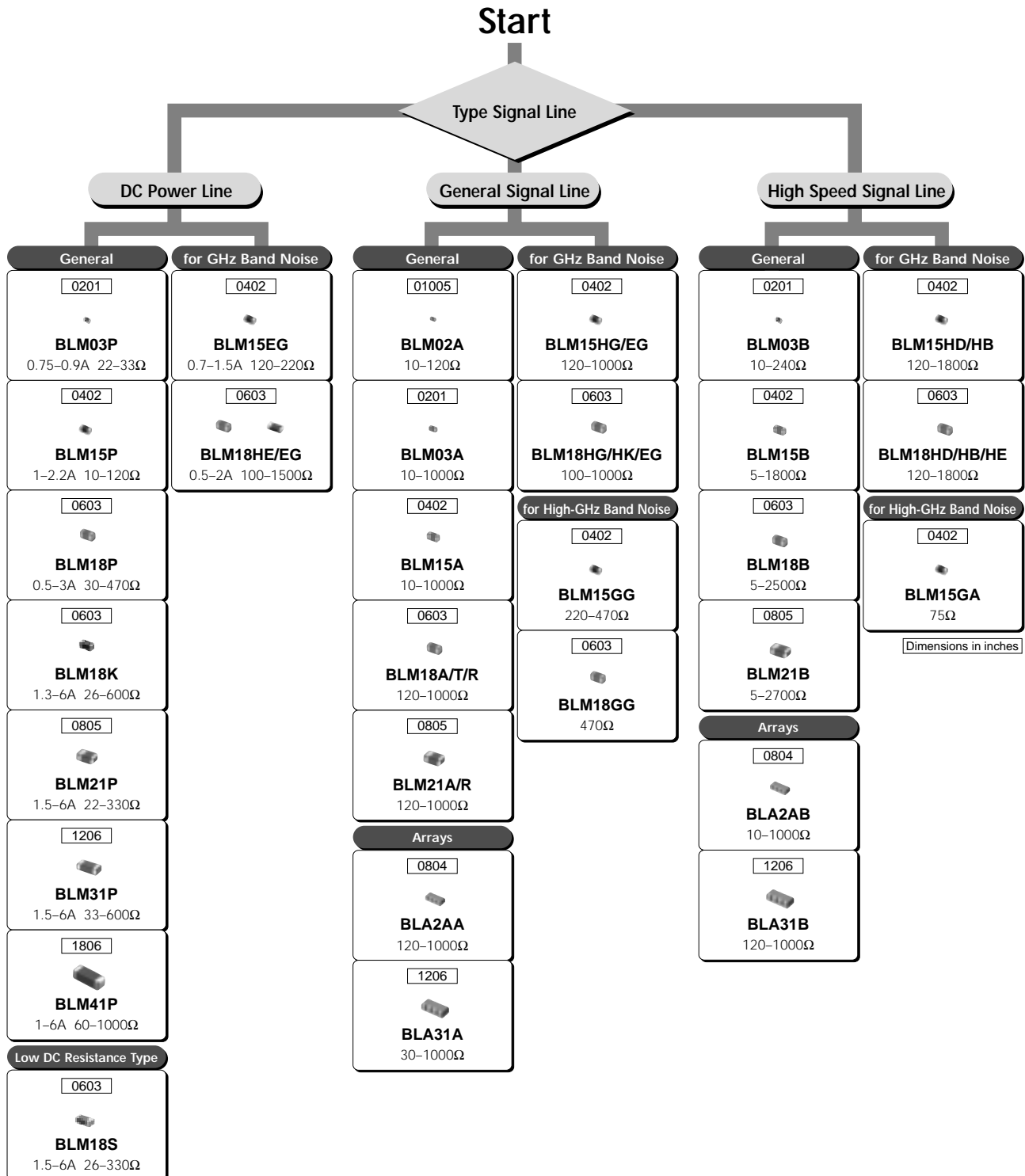

Impedance is typical value at 100MHz.

Selection Guide of EMI Filters

Chip EMIFIL®



Chip Common Mode Choke Coils

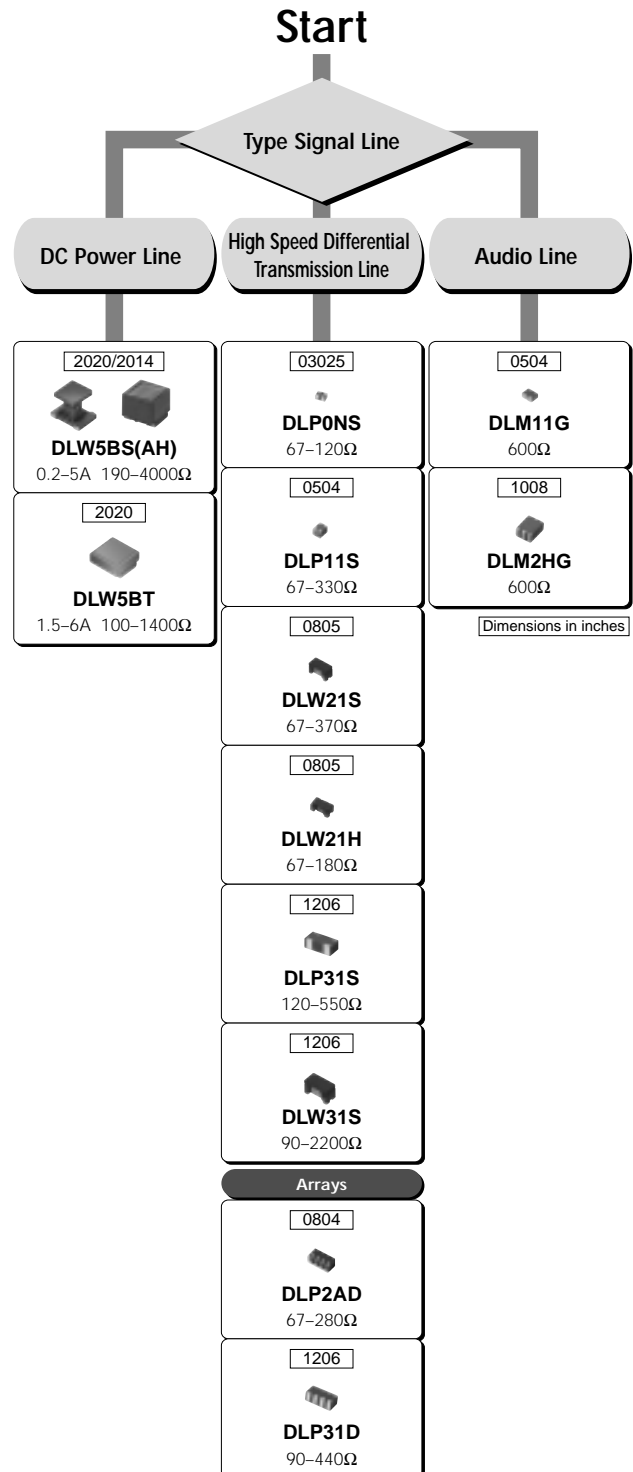

Impedance is typical value at 100MHz.

Product Guide/Effective Frequency Range

Product Guide

Inductor Type	Type	Series	Dimensions		Effective Frequency Range									
			(mm)	EIA Code	10kHz	100kHz	1MHz	10MHz	100MHz	1GHz	10GHz			
Inductor Type	For Digital Interfaces	BLM18R	1.6 ±0.8	0603										
		BLM21R	2.0 ±1.25	0805										
	Standard	BLM02A	0.4 ±0.2	01005										
		BLM03A	0.6 ±0.3	0201										
		BLM15A	1.0 ±0.5	0402										
		BLM18A	1.6 ±0.8	0603										
		BLM18T	1.6 ±0.8	0603										
		BLM21A	2.0 ±1.25	0805										
		BLA2AA (4 circuits array)	2.0 ±1.0	0804										
		BLA31A (4 circuits array)	3.2 ±1.6	1206										
		For High Speed Signals	BLM03B	0.6 ±0.3	0201									
	BLM15B		1.0 ±0.5	0402										
	BLM18B		1.6 ±0.8	0603										
	BLM21B		2.0 ±1.25	0805										
	BLA2AB (4 circuits array)		2.0 ±1.0	0804										
	BLA31B (4 circuits array)		3.2 ±1.6	1206										
	For High Current	BLM03P	0.6 ±0.3	0201										
		BLM15P	1.0 ±0.5	0402										
		BLM18P	1.6 ±0.8	0603										
		BLM18K	1.6 ±0.8	0603										
		BLM21P	2.0 ±1.25	0805										
		BLM31P	3.2 ±1.6	1206										
		BLM41P	4.5 ±1.6	1806										
BLM18S (Low DC Resistance Type)		1.6 ±0.8	0603											

Continued on the following page. 

Product Guide/Effective Frequency Range

Continued from the preceding page.

Type	Series	Dimensions		Effective Frequency Range										
		(mm)	EIA Code	10kHz	100kHz	1MHz	10MHz	100MHz	1GHz	10GHz				
Inductor Type	For GHz Band Noise Suppression	BLM15HG	1.0 ±0.5	0402										
		BLM15HB	1.0 ±0.5	0402										
		BLM15HD	1.0 ±0.5	0402										
		BLM15EG	1.0 ±0.5	0402										
		BLM18HG	1.6 ±0.8	0603										
		BLM18HB	1.6 ±0.8	0603										
		BLM18HD	1.6 ±0.8	0603										
		BLM18HE	1.6 ±0.8	0603										
		BLM18HK	1.6 ±0.8	0603										
		BLM18EG	1.6 ±0.8	0603										
		for High-GHz Band Noise Suppression	BLM15GG	1.0 ±0.5	0402									
			BLM15GA	1.0 ±0.5	0402									
			BLM18GG	1.6 ±0.8	0603									
	Capacitor Type	Standard Type	NFM18C	1.6 ±0.8	0603									
			NFM21C	2.0 ±1.25	0805									
			NFM3DC	3.2 ±1.25	1205									
			NFM41C	4.5 ±1.6	1806									
			NFA31C (4 circuits array)	3.2 ±1.6	1206									
For Signal Lines		NFL18ST	1.6 ±0.8	0603										
		NFL18SP	1.6 ±0.8	0603										
		NFL21S	2.0 ±1.25	0805										
		NFA18S (4 circuits array)	1.6 ±0.8	0603										
		NFA21S (4 circuits array)	2.0 ±1.25	0805										
		NFW31S	3.2 ±1.6	1206										
		NFR21G	2.0 ±1.25	0805										
		NFA31G (4 circuits array)	3.2 ±1.6	1206										
For High Current		NFM18P	1.6 ±0.8	0603										
		NFM21P	2.0 ±1.25	0805										
		NFM3DP	3.2 ±1.25	1205										
		NFM31P	3.2 ±1.6	1206										
		NFM41P	4.5 ±1.6	1806										
	NFM55P	5.7 5.0	2220											
T Filter for High Current	NFE31P	3.2 ±1.6	1206											
	NFE61P	6.8 ±1.6	2706											

Continued on the following page.

Product Guide/Effective Frequency Range

Continued from the preceding page.

Type	Series	Dimensions		Effective Frequency Range								
		(mm)	EIA Code	10kHz	100kHz	1MHz	10MHz	100MHz	1GHz	10GHz		
Common Mode Choke Coils 	DLP0NS	0.85 ■ ±0.65	03025									
	DLP11S	1.25 ■ ±1.0	0504									
	DLP31S	3.2 ■ ±1.6	1206									
	DLP2AD	2.0 ■ ±1.0	0804									
	DLP31D	3.2 ■ ±1.6	1206									
	DLM11G	1.25 ■ ±1.0	0504									
	DLM2HG	2.5 ■ ±2.0	1008									
	DLW21S	2.0 ■ ±1.2	0805									
	DLW21H	2.0 ■ ±1.2	0805									
	DLW31S	3.2 ■ ±1.6	1206									
	DLW5BS (DLW5AH)	5.0 ■ 5.0 ■ (3.6)	2020 (2014)									
DLW5BT	5.0 ■ 5.0	2020										
Disc EMIFIL® 	BL01/02/03 DSN6/9(H) DSS6/9(H) DST9(H)											
EMIGUARD® (EMI Filters with varistor functions) 	VFR3V VFS6V/9V											
Block EMIFIL® 	BNX022/023 BNX002/003/005 BNX012/016											
Common Mode Choke Coils 	PLT09H											
Microwave Absorbers 	EA10/20/21/22/30											

Outline of EMI Suppression Filters (EMIFIL®) for DC Line

- Chip Ferrite Bead
- Ferrite Bead Inductor

<p>Chip Ferrite Beadp.21-91</p> <div style="display: flex; justify-content: space-around; align-items: center;"> <div style="text-align: center;">  BLM02 </div> <div style="text-align: center;">  BLM03 </div> <div style="text-align: center;">  BLM15 </div> <div style="text-align: center;">  BLM18 </div> <div style="text-align: center;">  BLA2A </div> </div> <div style="display: flex; justify-content: space-around; align-items: center; margin-top: 20px;"> <div style="text-align: center;">  BLM21 </div> <div style="text-align: center;">  BLM31 </div> <div style="text-align: center;">  BLM41 </div> <div style="text-align: center;">  BLA31 </div> </div>	<p>Ferrite Bead Inductorp.146-148</p> <div style="display: flex; justify-content: space-around; align-items: center;"> <div style="text-align: center;">  BL01 </div> <div style="text-align: center;">  BL02RN1 </div> </div> <div style="display: flex; justify-content: space-around; align-items: center; margin-top: 20px;"> <div style="text-align: center;">  BL02RN2 </div> <div style="text-align: center;">  BL03RN2 </div> </div>
--	--

- Chip Ferrite Beads are effective for frequencies ranging from a few MHz to a few GHz. Chip Ferrite Beads are widely used as a low noise countermeasure, as well as a universal noise suppression component.
- Chip Ferrite Beads produce a micro inductance in the low frequency range. At high frequencies, however, the resistive component of the inductor produces the primary impedance. When inserted in series in the noise producing circuit, the resistive impedance of the inductor prevents noise propagation.

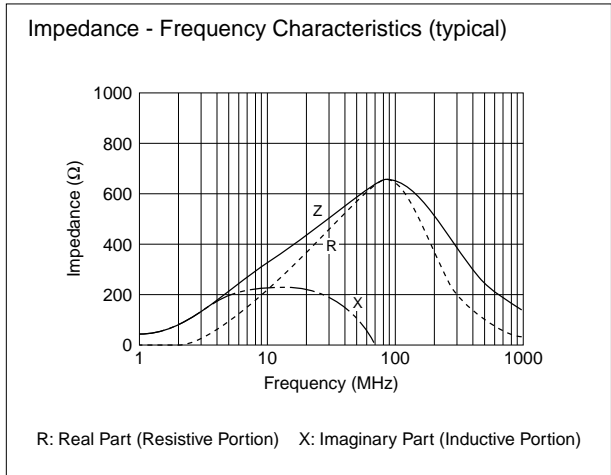
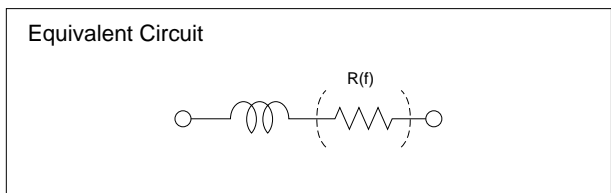

Outline of EMI Suppression Filters (EMIFIL®) for DC Line

- Chip EMIFIL®
- T-type Chip EMIFIL®
- Disk Type EMIFIL®

<p>Chip EMIFIL®p.95-99 p.103-105 p.114-120</p> <div style="display: flex; justify-content: space-around; align-items: center;"> <div style="text-align: center;">  NFM18P </div> <div style="text-align: center;">  NFM21C </div> <div style="text-align: center;">  NFM21P </div> <div style="text-align: center;">  NFM31P </div> </div> <div style="display: flex; justify-content: space-around; align-items: center; margin-top: 10px;"> <div style="text-align: center;">  NFM3DC </div> <div style="text-align: center;">  NFA31C </div> <div style="text-align: center;">  NFA18S </div> <div style="text-align: center;">  NFA21S </div> </div>	<p>T-type Chip EMIFIL®p.121-122</p> <div style="display: flex; justify-content: space-around; align-items: center; margin-top: 20px;"> <div style="text-align: center;">  NFE31P </div> <div style="text-align: center;">  NFE61P/H </div> </div>
<p>Disk Type EMIFIL®p.150-158</p> <div style="display: flex; justify-content: space-around; align-items: center; margin-top: 10px;"> <div style="text-align: center;">  DS06 </div> <div style="text-align: center;">  DS09 </div> <div style="text-align: center;">  DS09H </div> </div>	

- This capacitor type EMI suppression filter has a large noise suppression effect at frequencies ranging from a few MHz to hundreds of MHz. This type of filter is used widely as a universal, high performance EMI suppression component.
- The chip EMIFIL® incorporates a built-in three terminal capacitor, eliminating the lead wire and thereby increasing the high frequency performance characteristic.
- The T-type chip EMIFIL® is a chip EMI suppression filter with a built-in feed-thru capacitor. The use of ferrite beads on input and output terminals minimizes resonance with surrounding circuits.
- Whatever the situation, three terminal construction reduces residual inductance, thereby substantially improving noise suppression at frequencies over 10MHz.



Outline of EMI Suppression Filters (EMIFIL®) for DC Line

- Chip EMIFIL® for Signal Line
- Chip EMIFIL® with Waveform Distortion Suppressing Function

<p>Chip EMIFIL® for Signal Linep.34-49 p.69-71 p.74-78 p.100-102 p.106-107</p> <div style="display: flex; justify-content: space-around; align-items: flex-start;"> <div style="text-align: center;">  NFW31S </div> <div style="text-align: center;">  NFL18ST </div> <div style="text-align: center;">  NFL18SP </div> <div style="text-align: center;">  NFL21S </div> </div> <div style="display: flex; justify-content: space-around; align-items: flex-start; margin-top: 10px;"> <div style="text-align: center;">  BLM03B </div> <div style="text-align: center;">  BLM15B/HB/HD </div> <div style="text-align: center;">  BLM18B/HB/HD/HE </div> <div style="text-align: center;">  BLM21B </div> </div>	<p>Chip EMIFIL® with Waveform Distortion Suppressing Functionp.108-113</p> <div style="display: flex; justify-content: space-around; align-items: center; margin-top: 20px;"> <div style="text-align: center;">  NFR21G </div> <div style="text-align: center;">  NFA31G </div> </div>
---	--

- High-speed signal application EMIFIL® are high performance EMI suppression filters which increase the slope of insertion loss frequency characteristic curves (shape factor), thereby improving noise and signal separation. These are used for high speed signal applications in which noise and signal frequency approach the same value. To avoid the elimination of both the noise and specific signal components, three terminal capacitors and other components are applied. An NFW31S with a built-in capacitor and an inductor type BLM□□B are available. BLM□□HB/HD has additional performance for suppressing GHz range noise after cut-off frequency.
- The EMIFIL® with waveform distortion suppressing function suppresses waveform distortion caused by the resonance of digital ICs and surrounding circuits.

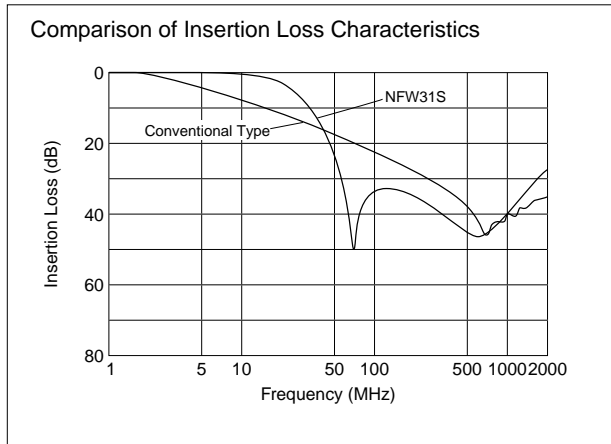

Outline of EMI Suppression Filters (EMIFIL®) for DC Line

- Chip Common Mode Choke Coil
- Common Mode Choke Coil

Chip Common Mode Choke Coilp.124-139					Common Mode Choke Coilp.168
DLP0NS	DLP11S	DLP31S	DLP2AD	DLP31D	
DLM11G	DLM2HG	DLW21S	DLW21H	DLW31S	
DLW5AH	DLW5BS	DLW5BT			

- These choke coils reduce common mode noise, which causes problems on balanced transmission lines, and are effective against common mode noise in the several MHz to several 100MHz frequency range. They are ideally suited for noise suppression on DC power supply lines and interface cables.

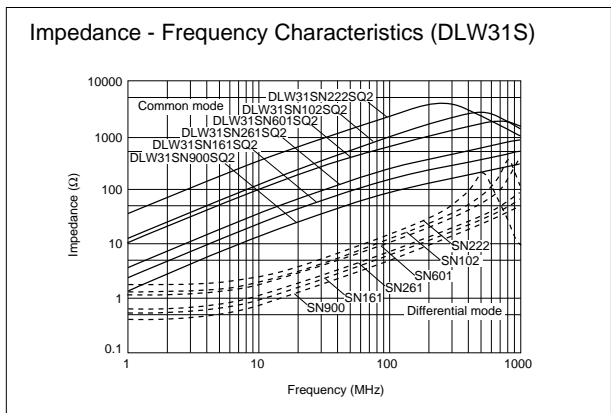
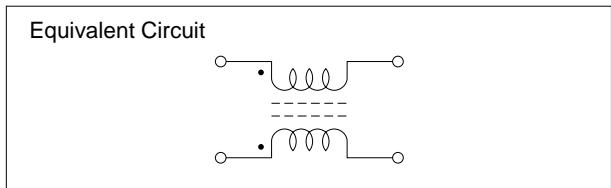

Outline of EMI Suppression Filters (EMIFIL®) for DC Line

● EMIGUARD®



- EMIGUARD® eliminates both surge noises and EMI noises due to its dielectric varistor material.
- Effective when high frequency noise and high voltage surge suppression are required, and also in situations when surging starts at extremely high speeds. This type of surging cannot be eliminated with general type varistors.

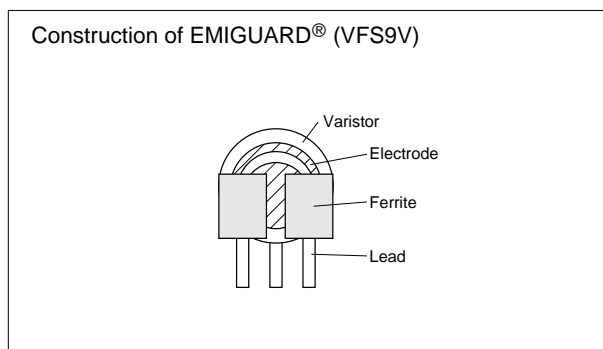

■ Surge Absorption Effect of EMIGUARD®

Type of Filter	Surge Absorption Effect of EMIGUARD®
No filter	
Three terminal capacitor is used to suppress the surge.	
EMIGUARD® is used to suppress the surge. (VFS6V)	

Outline of EMI Suppression Filters (EMIFIL®) for DC Line

●Block Type EMIFIL®

Block Type EMIFIL®p.140-144

BNX022/023 BNX002-01 BNX003-01 BNX005-01 BNX012-01 BNX016-01

- Block type EMIFIL® are resin encased, built-in, high performance EMI suppression filters, which use a feed-thru capacitor having excellent high frequency characteristics.
- Used when the noise frequency is high, or when extreme countermeasures are required.
- The high performance EMIFIL® BNX series exhibits significant noise suppression effects over a wide frequency band (extending from 100kHz to 1GHz) in DC power lines.

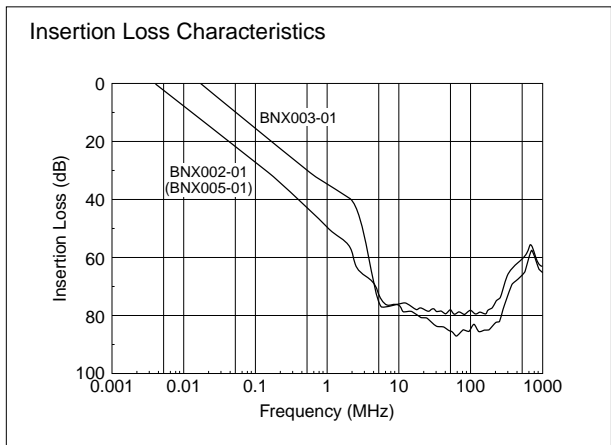
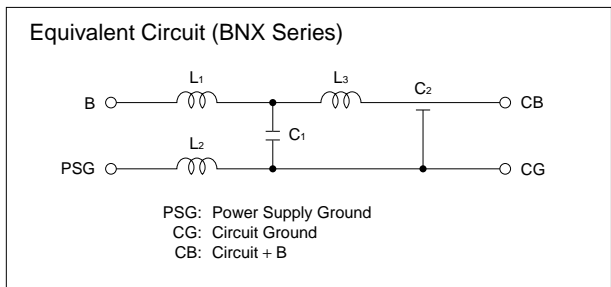

- In operating temperatures exceeding +85°C, derating of current is necessary for BNX010 series. Please apply the derating curve according to the operating temperature.

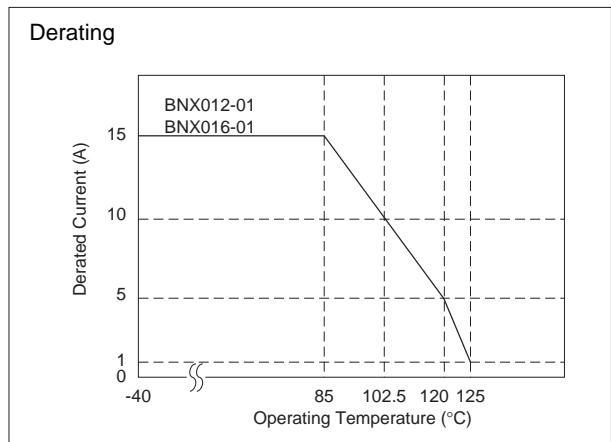

On-Board Type (DC) EMI Suppression Filters (EMIFIL®)



Chip Ferrite Beads Part Numbering

1

Chip Ferrite Beads

(Part Number)



① Product ID

Product ID	
BL	Chip Ferrite Beads

② Type

Code	Type
A	Array Type
M	Monolithic Type

③ Dimensions (L×W)

Code	Dimensions (L×W)	EIA
02	0.4×0.2mm	01005
03	0.6×0.3mm	0201
15	1.0×0.5mm	0402
18	1.6×0.8mm	0603
2A	2.0×1.0mm	0804
21	2.0×1.25mm	0805
31	3.2×1.6mm	1206
41	4.5×1.6mm	1806

④ Characteristics/Applications

Code *1	Characteristics/Applications	Series
AG	for General Use	BLM02/03/15/18/21, BLA2A/31
TG		BLM18
BA	for High-speed Signal Lines	BLM15/18
BB		BLM03/15/18/21, BLA2A
BD		BLM03/15/18/21, BLA2A/31
PD	for Power Supplies	BLM15
PG		BLM03/15/18/21/31/41
KG		BLM18
SG	for Power Supplies (Low DC Resistance Type)	BLM18
RK	for Digital Interface	BLM18/21
HG	for GHz Band General Use	BLM15/18
EG	for GHz Band General Use (Low DC Resistance Type)	
HB	for GHz Band High-speed Signal Lines	BLM15/18
HD		
HE		
HK	for GHz Band Digital Interface	BLM18
GA	for High-GHz Band High-speed Signal Lines	BLM15
GG	for High-GHz Band General Use	BLM15/18

*1 Frequency characteristics vary with each code.

⑤ Impedance

Expressed by three figures. The unit is in ohm (Ω) at 100MHz. The first and second figures are significant digits, and the third figure expresses the number of zeros which follow the two figures.

⑥ Electrode

Expressed by a letter.

Ex.)

Code	Electrode
S/T	Sn Plating
A	Au Plating

⑦ Category

Code	Category
N	Standard Type

⑧ Number of Circuits

Code	Number of Circuits
1	1 Circuit
4	4 Circuits

Continued on the following page.

 Continued from the preceding page.

 Packaging

Code	Packaging	Series
K	Embossed Taping (ø330mm Reel)	BLM21 *1/31/41
L	Embossed Taping (ø180mm Reel)	
B	Bulk	All Series
J	Paper Taping (ø330mm Reel)	BLM03/15/18 *3/21 *2, BLA2A/31
D	Paper Taping (ø180mm Reel)	BLM02/03/15/18/21 *2, BLA2A/31
C	Bulk Case	BLM15/18

*1 BLM21BD222SN1/BLM21BD272SN1 only.

*2 Except BLM21BD222SN1/BLM21BD272SN1

*3 Except BLM18T

1

On-Board Type (DC) EMI Suppression Filters (EMIFIL®)



Chip Ferrite Bead BLM Series

Covers Every Application in High Speed Signal Line, DC Power Lines and High-GHz Noise Suppression

1

The chip ferrite bead BLM series is comprised of ferrite beads in the shape of a chip. This ferrite bead generates a high impedance which at high frequencies mainly consists of a resistance element. BLM series is effective in circuits without stable ground lines because BLM series does not need a connection to ground.

Chip sizes of 0.4x0.2, 0.6x0.3, 1.0x0.5, 1.6x0.8, 2.0x1.25, 3.2x1.6 and 4.5x1.6mm are cataloged. (BLA series of array type chip ferrite beads is also cataloged.)

The nickel barrier structure of the external electrodes provides excellent solder heat resistance.

■Features

BLM series is comprised of R series (for digital interface), A/T series (for standard), B series (for high speed signal), P/S series (for large current), H/E series (for GHz band noise suppression), and G series (for High-GHz band noise suppression).

1. BLM□□R series – For Digital Interface
BLM-R series can be used in Digital Interface.
Resistance of BLM-R series especially grows in the lower frequency range. Therefore BLM-R series is less effective for digital signal waveform at low frequency range and can suppress the ringing.
2. BLM□□A/T series – For General Use
BLM-A series generates an impedance from the relatively low frequencies. Therefore BLM-A series is effective in noise suppression in the wide frequency range (30MHz – several hundred MHz).
3. BLM□□B series – For High Speed Signal
BLM-B series can minimize attenuation of the signal waveform due to its sharp impedance characteristics. Various impedances are available to match signal frequency.

4. BLM□□P/S series – For Large Current
BLM-P/S series can be used in high current circuits due to its low DC resistance. It can match power lines to a maximum of 6A DC.
5. BLM□□H/E series – For GHz Band Noise Suppression
BLM□□H/E series has horizontal wire wound structure that minimizes stray capacitance and increases the effective frequency range.
6. BLM□□G series – For High-GHz Band Noise Suppression
BLM□□G series has improved the performance in High-GHz frequency area using newly developed low dielectric ferrite material.

Impedance Characteristics

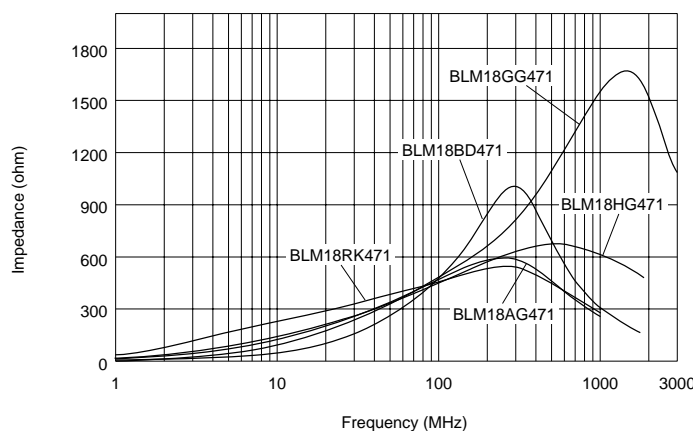

■ Impedance Map

1

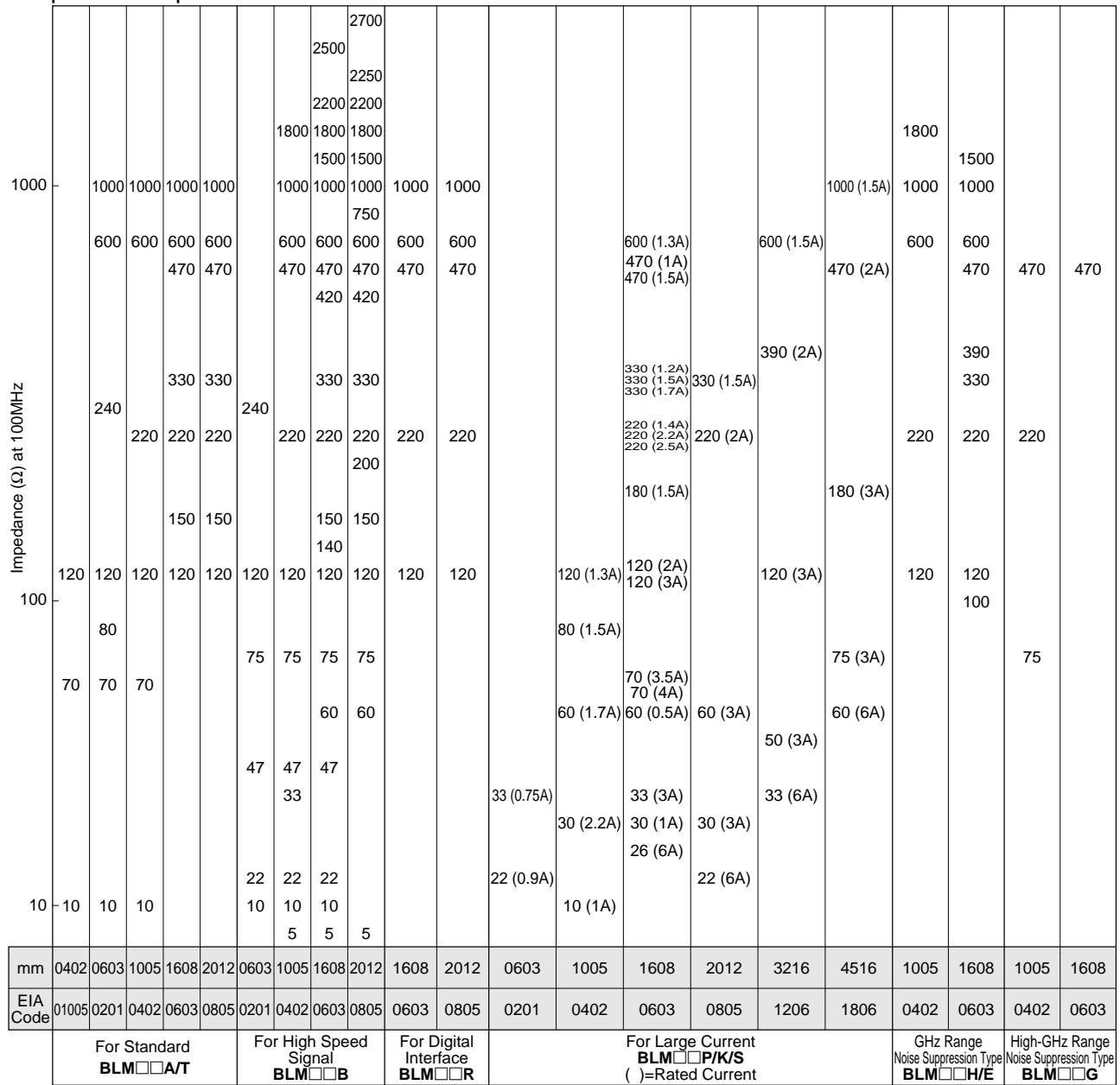

■BLM Series

Size (EIA Code)	Type	Part Number	Impedance (Ω)		Rated Current (mA)
			at 100MHz	at 1GHz	
01005	For Standard (p. 21 - 22)	BLM02AG100SN1	10 (Typ.)	-	500
		BLM02AG700SN1	70±25%	-	250
		BLM02AG121SN1	120±25%	-	200
0201	For Standard (p. 23 - 24)	BLM03AG100SN1	10 (Typ.)	-	500
		BLM03AG700SN1	70 (Typ.)	-	200
		BLM03AG800SN1	80±25%	-	200
		BLM03AG121SN1	120±25%	-	200
		BLM03AG241SN1	240±25%	-	200
		BLM03AG601SN1	600±25%	-	100
		BLM03AG102SN1	1000±25%	-	100
	For High Speed Signal (p. 34 - 35)	BLM03BB100SN1	10±25%	-	300
		BLM03BB220SN1	22±25%	-	200
		BLM03BB470SN1	47±25%	-	
		BLM03BB750SN1	75±25%	-	
		BLM03BB121SN1	120±25%	-	100
		BLM03BD750SN1	75±25%	-	300
		BLM03BD121SN1	120±25%	-	250
		BLM03BD241SN1	240±25%	-	200
	For Large Current (p. 55 - 56)	BLM03PG220SN1	22±25%	-	900
		BLM03PG330SN1	33±25%	-	750
	0402	For Standard (p. 25 - 26, p. 31)	BLM15AG100SN1	10 (Typ.)	-
BLM15AG700SN1			70 (Typ.)	-	500
BLM15AG121SN1			120±25%	-	
BLM15AG221SN1			220±25%	-	300
BLM15AG601SN1			600±25%	-	
BLM15AG102SN1			1000±25%	-	200
BLM15AG601AN1			600±25%	-	300
BLM15AG102AN1		1000±25%	-	200	
For High Speed Signal (Sharp impedance characteristics) (p. 36 - 39)		BLM15BA050SN1	5±25%	-	300
		BLM15BB050SN1		-	500
		BLM15BA100SN1	10±25%	-	300
		BLM15BB100SN1		-	
		BLM15BA220SN1	22±25%	-	300
		BLM15BB220SN1		-	
		BLM15BA330SN1	33±25%	-	200
		BLM15BA470SN1	47±25%	-	
		BLM15BB470SN1	75±25%	-	300
		BLM15BA750SN1		-	200
		BLM15BB750SN1	-	300	
		BLM15BB121SN1	120±25%		-
		BLM15BB221SN1	220±25%	-	200
		BLM15BD750SN1	75±25%	-	300
		BLM15BD121SN1	120±25%	-	
		BLM15BD221SN1	220±25%	-	200
		BLM15BD471SN1	470±25%	-	
BLM15BD601SN1		600±25%	-	100	
BLM15BD102SN1		1000±25%	-		
BLM15BD182SN1		1800±25%	-	100	
For Large Current (p. 56 - 57)		BLM15PG100SN1	10 (Typ.)	-	1000
		BLM15PD300SN1	30±25%	-	2200*
		BLM15PD600SN1	60±25%	-	1700*
		BLM15PD800SN1	80±25%	-	1500*
	BLM15PD121SN1	120±25%	-	1300*	

* Please see p.57 "Derating of Rated Current".

Continued on the following page. 

1

Continued from the preceding page.

Size (EIA Code)	Type		Part Number	Impedance (Ω)		Rated Current (mA)
				at 100MHz	at 1GHz	
0402	GHz Band	For Standard (p. 69 – 70)	BLM15HG601SN1	600±25%	1000±40%	300
			BLM15HG102SN1	1000±25%	1400±40%	250
		For High Speed Signal (p. 69 – 71)	BLM15HB121SN1	120±25%	500±40%	300
			BLM15HB221SN1	220±25%	900±40%	250
			BLM15HD601SN1	600±25%	1400±40%	300
			BLM15HD102SN1	1000±25%	2000±40%	250
	For Standard (Low DC Resistance Type) (p. 72)	BLM15HD182SN1	1800±25%	2700±40%	200	
		BLM15EG121SN1	120±25%	145 (Typ.)	1500*	
	High-GHz Band	For Standard (Low DC Resistance Type) (p. 81 – 82)	BLM15EG221SN1	220±25%	270 (Typ.)	700*
			BLM15GA750SN1	75±25%	1000±40%	200
0603	For Standard (p. 27 – 28, p. 32 – 33)	BLM15GG221SN1	220±25%	600±40%	300	
		BLM15GG471SN1	470±25%	1200±40%	200	
		BLM18AG121SN1	120±25%	-	500	
		BLM18AG151SN1	150±25%	-		
		BLM18AG221SN1	220±25%	-		
		BLM18AG331SN1	330±25%	-		
		BLM18AG471SN1	470±25%	-		
		BLM18AG601SN1	600±25%	-	400	
		BLM18AG102SN1	1000±25%	-		
		BLM18TG121TN1	120±25%	-	200	
	BLM18TG221TN1	220±25%	-			
	BLM18TG601TN1	600±25%	-			
	For High Speed Signal (Sharp impedance characteristics) (p. 40 – 45)	BLM18TG102TN1	1000±25%	-	100	
		BLM18BA050SN1	5±25%	-	500	
		BLM18BB050SN1		-	700	
		BLM18BA100SN1	10±25%	-	500	
		BLM18BB100SN1		-	700	
		BLM18BA220SN1	22±25%	-	500	
		BLM18BB220SN1		-	600	
		BLM18BA470SN1	47±25%	-	300	
		BLM18BB470SN1		-	550	
		BLM18BD470SN1		-	500	
		BLM18BB600SN1	60±25%	-	550	
		BLM18BA750SN1	75±25%	-	300	
		BLM18BB750SN1		-	500	
		BLM18BA121SN1	120±25%	-	200	
		BLM18BB121SN1		-	500	
		BLM18BD121SN1		-	200	
		BLM18BB141SN1	140±25%	-	450	
		BLM18BB151SN1	150±25%	-	450	
		BLM18BD151SN1		-	200	
		BLM18BB221SN1	220±25%	-	450	
		BLM18BD221SN1		-	200	
		BLM18BB331SN1	330±25%	-	400	
		BLM18BD331SN1		-	200	
		BLM18BD421SN1	420±25%	-	200	
		BLM18BB471SN1	470±25%	-	300	
		BLM18BD471SN1		-	200	
		BLM18BD601SN1	600±25%	-	200	
		BLM18BD102SN1	1000±25%	-	100	
		BLM18BD152SN1	1500±25%	-	50	
		BLM18BD182SN1	1800±25%	-		
	BLM18BD222SN1	2200±25%	-			
	BLM18BD252SN1	2500±25%	-			

* Please see p.73 "Derating of Rated Current".

Continued on the following page. ↗

Continued from the preceding page.

Size (inches)	Type		Part Number	Impedance (Ω)		Rated Current (mA)		
				at 100MHz	at 1GHz			
0603	For Digital Interface (p. 50 – 51)		BLM18RK121SN1	120±25%	-	200		
			BLM18RK221SN1	220±25%	-			
			BLM18RK471SN1	470±25%	-			
			BLM18RK601SN1	600±25%	-			
			BLM18RK102SN1	1000±25%	-			
	For Large Current		For Standard (p. 58 – 59 p. 64 – 66)	BLM18PG300SN1	30 (Typ.)	-	1000	
				BLM18PG330SN1	33±25%	-	3000*	
				BLM18PG600SN1	60 (Typ.)	-	500	
				BLM18PG121SN1	120±25%	-	2000*	
				BLM18PG181SN1	180±25%	-	1500*	
				BLM18PG221SN1	220±25%	-	1400*	
				BLM18PG331SN1	330±25%	-	1200*	
				BLM18PG471SN1	470±25%	-	1000	
				BLM18KG260TN1	26±25%	-	6000*	
				BLM18KG700TN1	70±25%	-	3500*	
				BLM18KG121TN1	120±25%	-	3000*	
				BLM18KG221SN1	220±25%	-	2200*	
				BLM18KG331SN1	330±25%	-	1700*	
				BLM18KG471SN1	470±25%	-	1500*	
				BLM18KG601SN1	600±25%	-	1300*	
			For Standard (Low DC Resistance Type) (p. 67 – 68)		BLM18SG260TN1	26±25%	-	6000*
					BLM18SG700TN1	70±25%	-	4000*
					BLM18SG121TN1	120±25%	-	3000*
					BLM18SG221TN1	220±25%	-	2500*
					BLM18SG331TN1	330±25%	-	1500*
	GHz Band		For Standard (p. 74 – 76)	BLM18HG471SN1	470±25%	600 (Typ.)	200	
				BLM18HG601SN1	600±25%	700 (Typ.)		
				BLM18HG102SN1	1000±25%	1000 (Typ.)		
			For High Speed Signal (p. 74 – 77)		BLM18HB121SN1	120±25%	500±40%	200
					BLM18HB221SN1	220±25%	1100±40%	100
					BLM18HB331SN1	330±25%	1600±40%	50
					BLM18HD471SN1	470±25%	1000 (Typ.)	100
					BLM18HD601SN1	600±25%	1200 (Typ.)	
					BLM18HD102SN1	1000±25%	1700 (Typ.)	50
					BLM18HE601SN1	600±25%	600 (Typ.)	800*
					BLM18HE102SN1	1000±25%	1000 (Typ.)	600*
					BLM18HE152SN1	1500±25%	1500 (Typ.)	500*
					For Digital Interface (p. 74 – 77)		BLM18HK331SN1	330±25%
			BLM18HK471SN1	470±25%			600±40%	
			BLM18HK601SN1	600±25%			700±40%	100
BLM18HK102SN1			1000±25%	1200±40%			50	
For Standard (Low DC Resistance Type) (p. 78 – 79)			BLM18EG101TN1	100±25%			140 (Typ.)	2000*
			BLM18EG121SN1	120±25%	145 (Typ.)	2000*		
			BLM18EG221TN1	220±25%	300 (Typ.)	1000		
			BLM18EG221SN1		260 (Typ.)	2000*		
		BLM18EG331TN1	330±25%	450 (Typ.)	500			
		BLM18EG391TN1	390±25%	520 (Typ.)	500			
		BLM18EG471SN1	470±25%	550 (Typ.)	500			
		BLM18EG601SN1	600±25%	700 (Typ.)	500			
		High-GHz Band		(p. 83)	BLM18GG471SN1	470±25%	1800±30%	200

* Please see p.68, p.78, p.80 "Derating of Rated Current".

Continued on the following page. ↗

1

Continued from the preceding page.

Size (inches)	Type	Part Number	Impedance (Ω)		Rated Current (mA)
			at 100MHz	at 1GHz	
0805	For Standard (p. 29 - 30)	BLM21AG121SN1	120±25%	-	200
		BLM21AG151SN1	150±25%	-	
		BLM21AG221SN1	220±25%	-	
		BLM21AG331SN1	330±25%	-	
		BLM21AG471SN1	470±25%	-	
		BLM21AG601SN1	600±25%	-	
		BLM21AG102SN1	1000±25%	-	
	For High Speed Signal (Sharp impedance characteristics) (p. 46 - 49)	BLM21BB050SN1	5±25%	-	200
		BLM21BB600SN1	60±25%	-	
		BLM21BB750SN1	75±25%	-	
		BLM21BB121SN1	120±25%	-	
		BLM21BD121SN1		-	
		BLM21BB151SN1	150±25%	-	
		BLM21BD151SN1		-	
		BLM21BB201SN1	200±25%	-	
		BLM21BB221SN1	220±25%	-	
		BLM21BD221SN1		-	
		BLM21BB331SN1	330±25%	-	
		BLM21BD331SN1		-	
		BLM21BD421SN1	420±25%	-	
		BLM21BB471SN1	470±25%	-	
		BLM21BD471SN1		-	
		BLM21BD601SN1	600±25%	-	
		BLM21BD751SN1	750±25%	-	
		BLM21BD102SN1	1000±25%	-	
		BLM21BD152SN1	1500±25%	-	
		BLM21BD182SN1	1800±25%	-	
	BLM21BD222SN1	2250 (Typ.)	-		
	BLM21BD222TN1	2200±25%	-		
	BLM21BD272SN1	2700±25%	-		
	For Digital Interface (p. 52 - 53)	BLM21RK121SN1	120±25%	-	200
		BLM21RK221SN1	220±25%	-	
		BLM21RK471SN1	470±25%	-	
		BLM21RK601SN1	600±25%	-	
		BLM21RK102SN1	1000±25%	-	
	For Large Current (p. 60 - 61)	BLM21PG220SN1	22±25%	-	6000*
BLM21PG300SN1		30 (Typ.)	-	3000*	
BLM21PG600SN1		60±25%	-	2000*	
BLM21PG221SN1		220±25%	-	1500*	
BLM21PG331SN1		330±25%	-	1500*	
1206	For Large Current (p. 61 - 62)	BLM31PG330SN1	33±25%	-	6000*
		BLM31PG500SN1	50 (Typ.)	-	3000*
		BLM31PG121SN1	120±25%	-	2000*
		BLM31PG391SN1	390±25%	-	1500*
		BLM31PG601SN1	600±25%	-	1500*
1806	For Large Current (p. 63 - 64)	BLM41PG600SN1	60 (Typ.)	-	6000*
		BLM41PG750SN1	75 (Typ.)	-	3000*
		BLM41PG181SN1	180±25%	-	3000*
		BLM41PG471SN1	470±25%	-	2000*
		BLM41PG102SN1	1000±25%	-	1500*

* Please see p.68 "Derating of Rated Current".

On-Board Type (DC) EMI Suppression Filters (EMIFIL®)



Chip Ferrite Beads BLM02/03/15/18/21/31/41 Series

■ Features (BLM_A Series)

The chip ferrite beads BLM series is designed to function nearly as a resistor at noise frequencies, which greatly reduces the possibility of resonance and leaves signal wave forms undistorted.

BLM series is effective in circuits without stable ground lines because BLM series does not need a connection to ground.

The nickel barrier structure of the external electrodes provides excellent solder heat resistance. BLM_A series generates an impedance from the relatively low frequencies. Therefore BLM_A series is effective in noise suppression in a wide frequency range (30MHz to several hundred MHz).

The small size of BLM02A series (0.4x0.2mm) is suitable for noise suppression in small equipment such as PA modules for cellular phones.

■ Equivalent Circuit



1

BLM02A Series (01005 Size)



Part Number	Impedance (at 100MHz/20°C) (ohm)	Rated Current (mA)	DC Resistance (max.) (ohm)	Operating Temperature Range (°C)
BLM02AG100SN1	10 (Typ.)	500	0.1	-55 to +125
BLM02AG700SN1	70 ±25%	250	0.5	-55 to +125
BLM02AG121SN1	120 ±25%	200	0.8	-55 to +125

■ Impedance - Frequency (Typical)

BLM02A Series

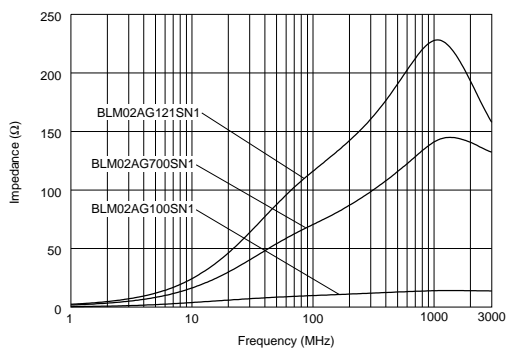

1

■ Impedance - Frequency Characteristics

BLM02AG100SN1

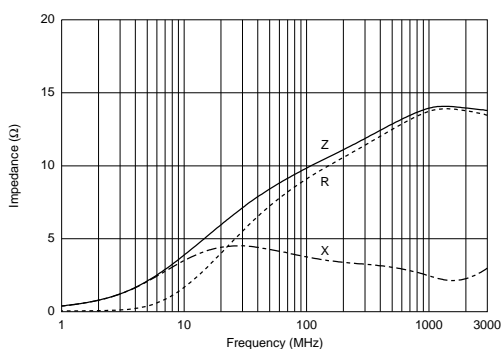

BLM02AG700SN1



BLM02AG121SN1

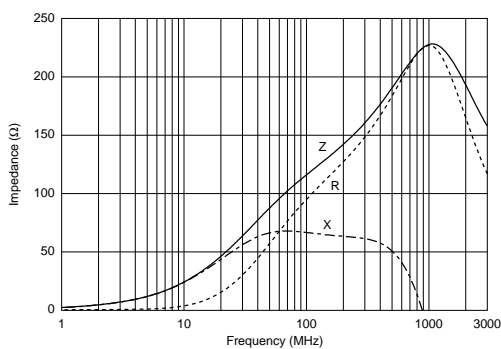

BLM03A Series (0201 Size)

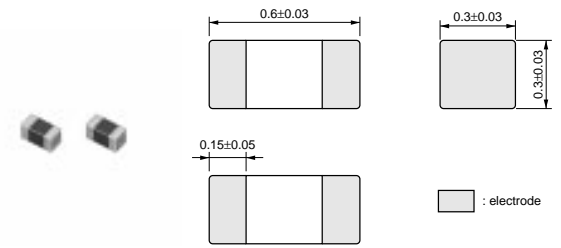

BLM03A Series

(in mm)

1

Part Number	Impedance (at 100MHz/20°C) (ohm)	Rated Current (mA)	DC Resistance (max.) (ohm)	Operating Temperature Range (°C)
BLM03AG100SN1	10 (Typ.)	500	0.1	-55 to +125
BLM03AG700SN1	70 (Typ.)	200	0.4	-55 to +125
BLM03AG800SN1	80 ±25%	200	0.4	-55 to +125
BLM03AG121SN1	120 ±25%	200	0.5	-55 to +125
BLM03AG241SN1	240 ±25%	200	0.8	-55 to +125
BLM03AG601SN1	600 ±25%	100	1.5	-55 to +125
BLM03AG102SN1	1000 ±25%	100	2.5	-55 to +125

■ Impedance - Frequency (Typical)

BLM03A Series

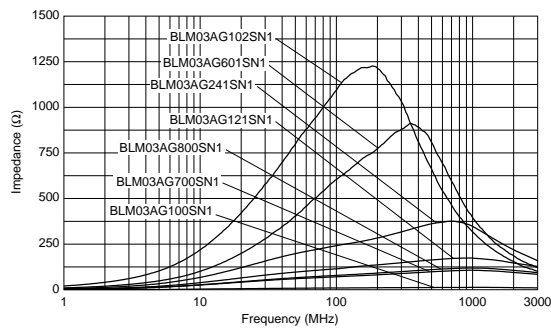

■ Impedance - Frequency Characteristics

BLM03AG100SN1

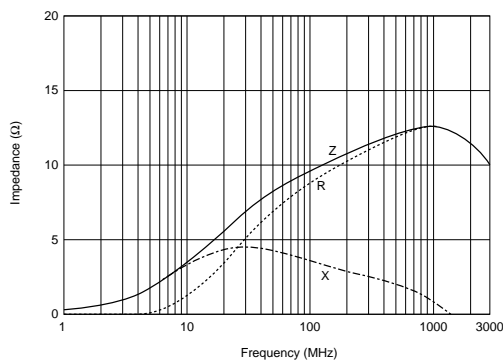

BLM03AG700SN1

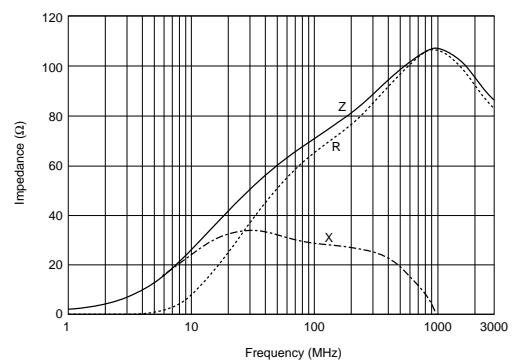

Continued on the following page. ↗

Continued from the preceding page.

Impedance - Frequency Characteristics

BLM03AG800SN1

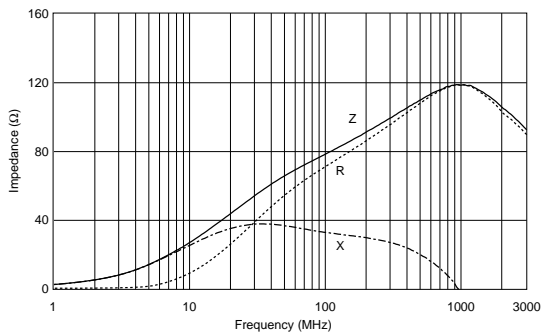

BLM03AG121SN1

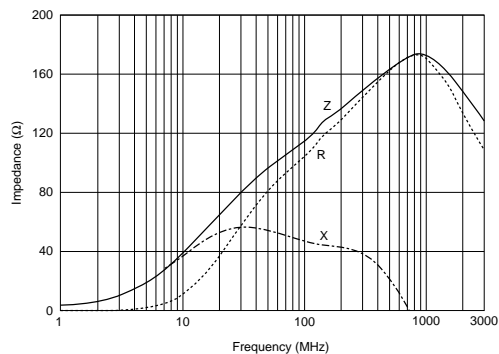

BLM03AG241SN1

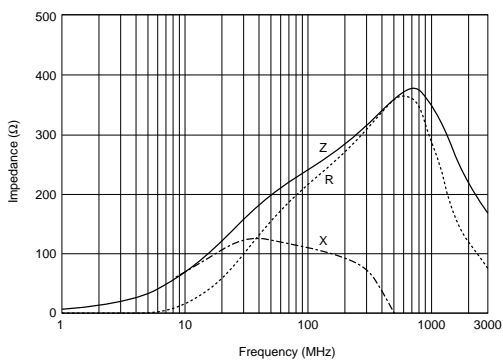

BLM03AG601SN1

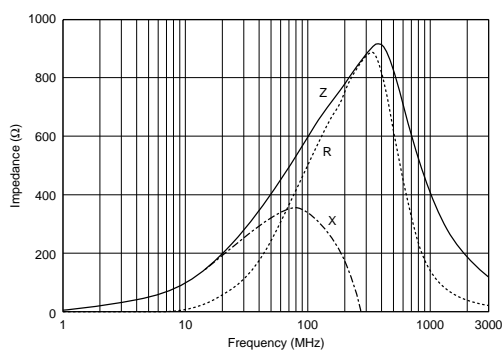

BLM03AG102SN1

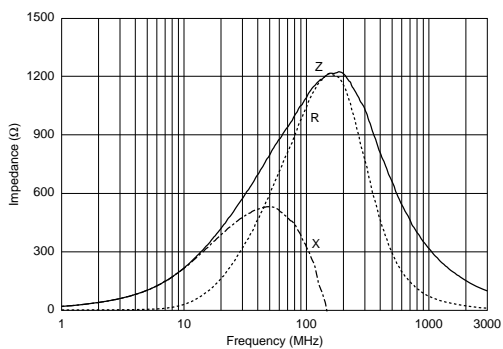

1

BLM15A Series (0402 Size)



1

Part Number	Impedance (at 100MHz/20°C) (ohm)	Rated Current (mA)	DC Resistance (max.) (ohm)	Operating Temperature Range (°C)
BLM15AG100SN1	10 (Typ.)	1000	0.05	-55 to +125
BLM15AG700SN1	70 (Typ.)	500	0.15	-55 to +125
BLM15AG121SN1	120 ±25%	500	0.25	-55 to +125
BLM15AG221SN1	220 ±25%	300	0.35	-55 to +125
BLM15AG601SN1	600 ±25%	300	0.6	-55 to +125
BLM15AG102SN1	1000 ±25%	200	1.0	-55 to +125

■ Impedance - Frequency (Typical)

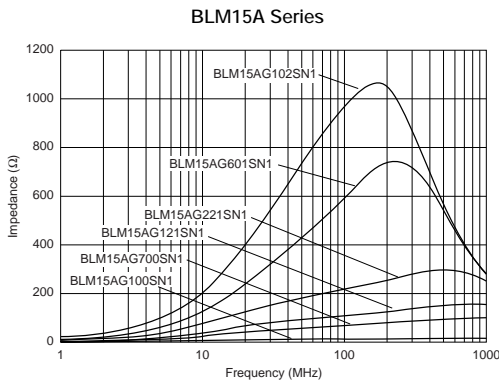

■ Impedance - Frequency Characteristics



Continued on the following page. ↗

Continued from the preceding page.

■ Impedance - Frequency Characteristics

BLM15AG121SN1



BLM15AG221SN1



BLM15AG601SN1

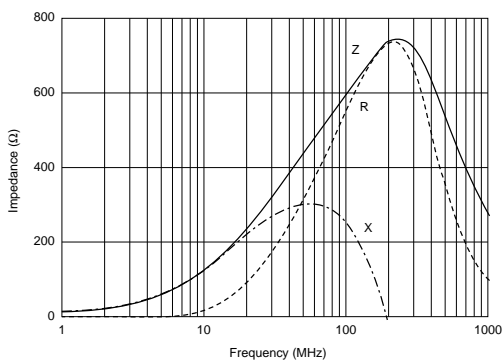

BLM15AG102SN1

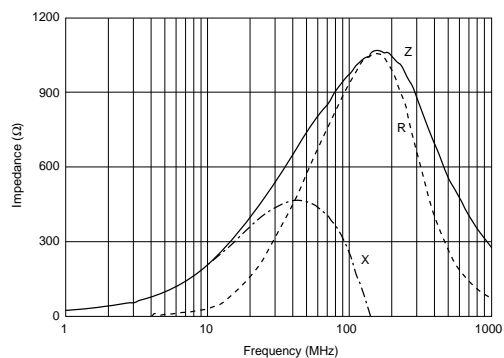

1

BLM18A Series (0603 Size)



1

Part Number	Impedance (at 100MHz/20°C) (ohm)	Rated Current (mA)	DC Resistance (max.) (ohm)	Operating Temperature Range (°C)
BLM18AG121SN1	120 ±25%	500	0.18	-55 to +125
BLM18AG151SN1	150 ±25%	500	0.25	-55 to +125
BLM18AG221SN1	220 ±25%	500	0.25	-55 to +125
BLM18AG331SN1	330 ±25%	500	0.30	-55 to +125
BLM18AG471SN1	470 ±25%	500	0.35	-55 to +125
BLM18AG601SN1	600 ±25%	500	0.38	-55 to +125
BLM18AG102SN1	1000 ±25%	400	0.50	-55 to +125

■ Impedance - Frequency (Typical)



■ Impedance - Frequency Characteristics

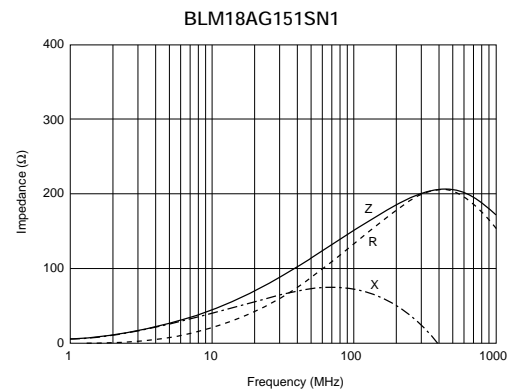
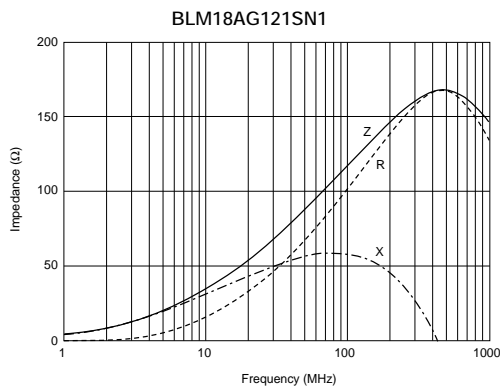

Continued on the following page. ↗

Continued from the preceding page.

■ Impedance - Frequency Characteristics

BLM18AG221SN1

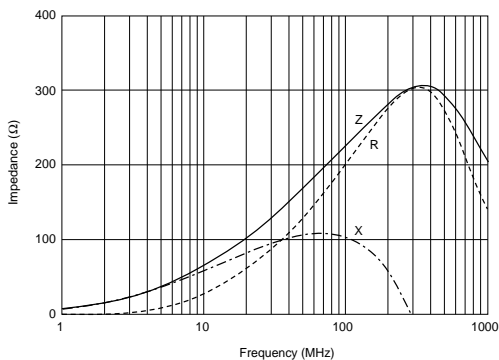

BLM18AG331SN1



BLM18AG471SN1

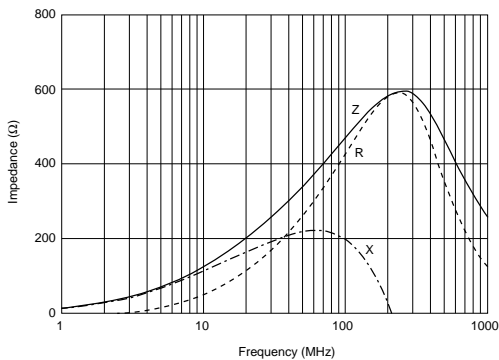

BLM18AG601SN1



BLM18AG102SN1



1

BLM21A Series (0805 Size)



1

Part Number	Impedance (at 100MHz/20°C) (ohm)	Rated Current (mA)	DC Resistance (max.) (ohm)	Operating Temperature Range (°C)
BLM21AG121SN1	120 ±25%	200	0.15	-55 to +125
BLM21AG151SN1	150 ±25%	200	0.15	-55 to +125
BLM21AG221SN1	220 ±25%	200	0.20	-55 to +125
BLM21AG331SN1	330 ±25%	200	0.25	-55 to +125
BLM21AG471SN1	470 ±25%	200	0.25	-55 to +125
BLM21AG601SN1	600 ±25%	200	0.30	-55 to +125
BLM21AG102SN1	1000 ±25%	200	0.45	-55 to +125

■ Impedance - Frequency (Typical)

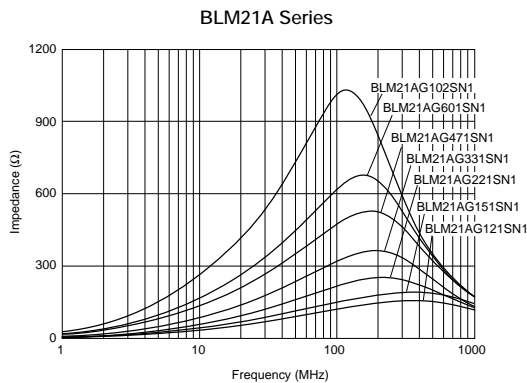

■ Impedance - Frequency Characteristics

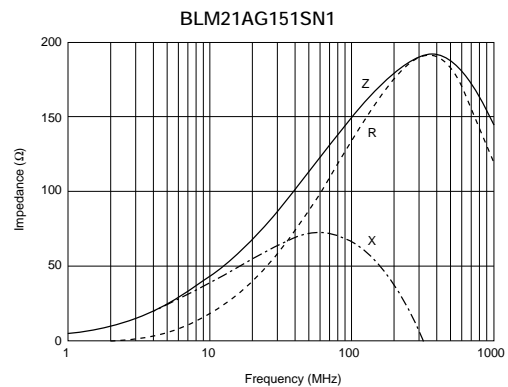
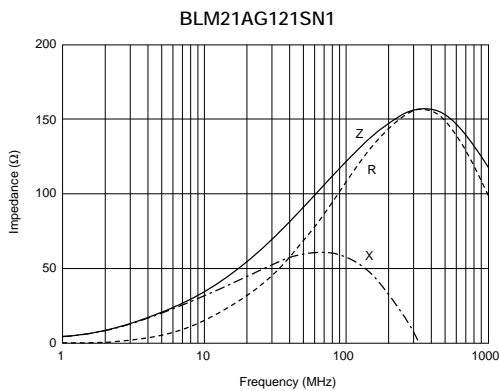

Continued on the following page. ↗

Continued from the preceding page.

Impedance - Frequency Characteristics

1

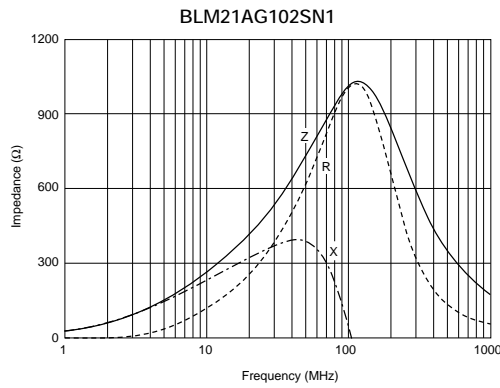
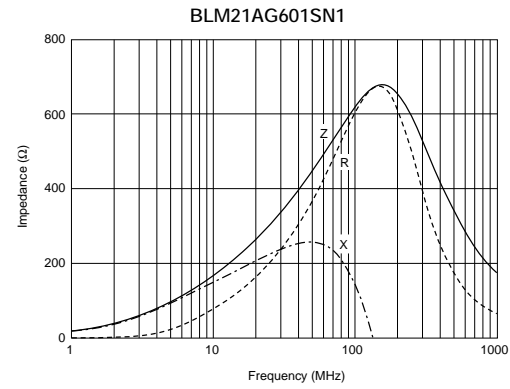
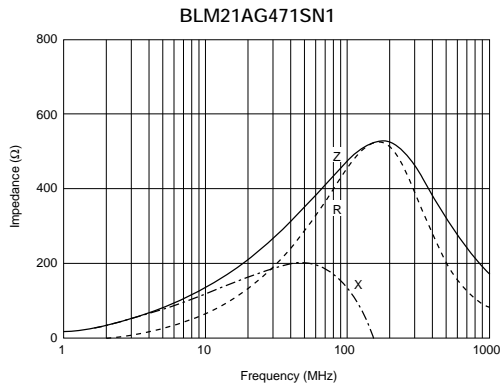
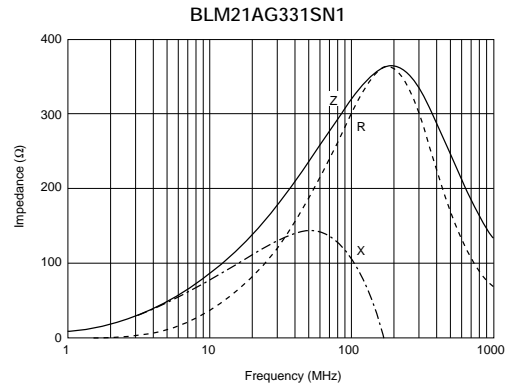
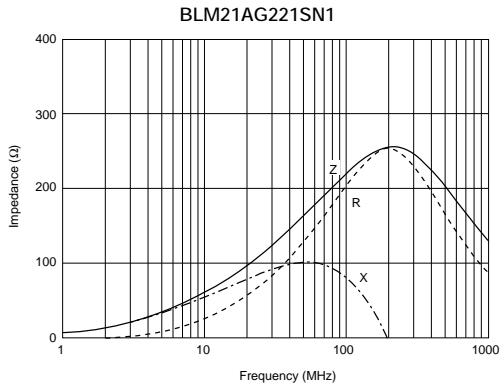

BLM15A Series Gold Plating (0402 Size)

■ Features

1. Au plating for wire bonding mounting
2. BLM_A series generates an impedance from the relatively low frequencies. Therefore BLM_A series is effective in noise suppression in a wide frequency range (30MHz to several hundred MHz).

■ Applications

1. Optical transceiver modules
2. Optical pickup modules



1

Part Number	Impedance (at 100MHz/20°C) (ohm)	Rated Current (mA)	DC Resistance (max.) (ohm)	Operating Temperature Range (°C)
BLM15AG601AN1	600 ±25%	300	0.6	-55 to +125
BLM15AG102AN1	1000 ±25%	200	1.0	-55 to +125

■ Impedance - Frequency (Typical)

BLM15A Series (gold plating)

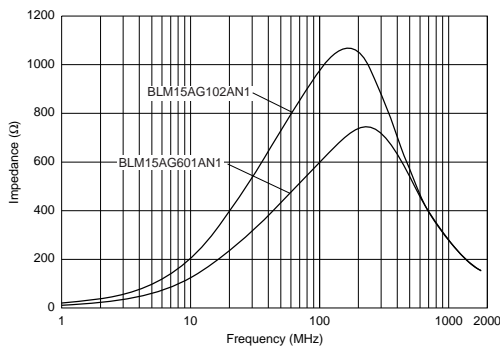

■ Impedance - Frequency Characteristics

BLM15AG601AN1

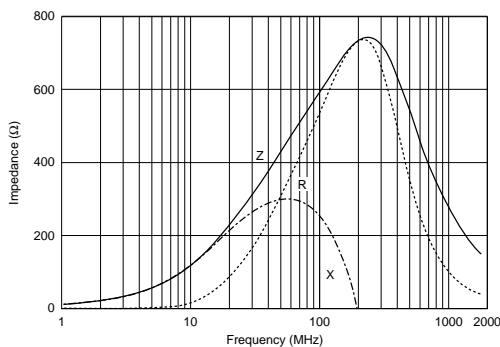

BLM15AG102AN1

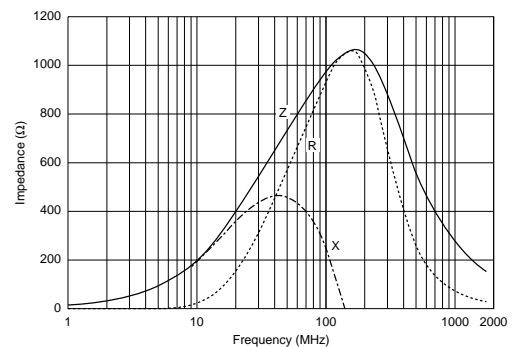

BLM18T Series (0603 Size)

■ Features

The chip ferrite beads BLM series is designed to function nearly as a resistor at noise frequencies, which greatly reduces the possibility of resonance and leaves signal wave forms undistorted.

BLM series is effective in circuits without stable ground lines because BLM series does not need a connection to ground.

The nickel barrier structure of the external electrodes provides excellent solder heat resistance.

BLM_T series generates an impedance from the relatively low frequencies. Therefore BLM_T series is effective in noise suppression in a wide frequency range (10MHz to several hundred MHz).

BLM_T series contributes further to miniaturizing portable equipment.



Part Number	Impedance (at 100MHz/20°C) (ohm)	Rated Current (mA)	DC Resistance (max.) (ohm)	Operating Temperature Range (°C)
BLM18TG121TN1	120 ±25%	200	0.25	-55 to +125
BLM18TG221TN1	220 ±25%	200	0.30	-55 to +125
BLM18TG601TN1	600 ±25%	200	0.45	-55 to +125
BLM18TG102TN1	1000 ±25%	100	0.60	-55 to +125

■ Impedance - Frequency (Typical)

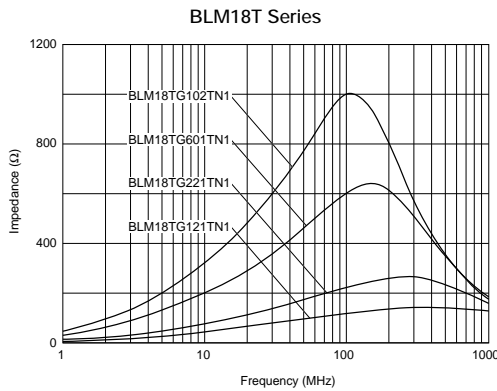

■ Impedance - Frequency Characteristics

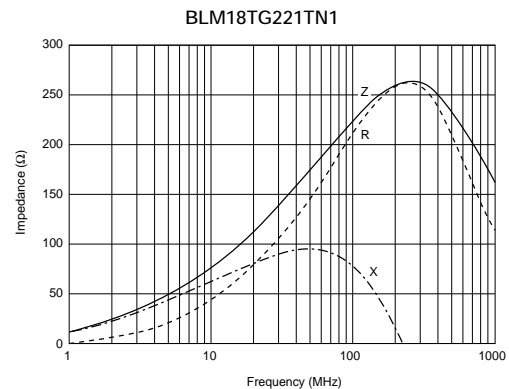
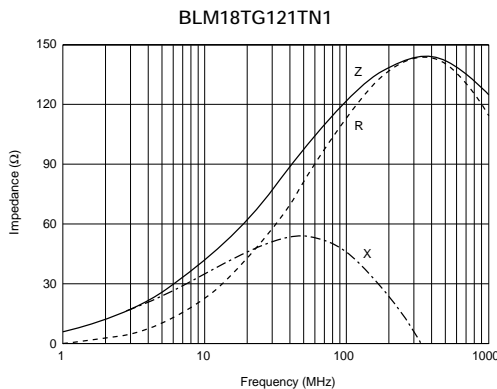

Continued on the following page. ↗

☐ Continued from the preceding page.

■ Impedance - Frequency Characteristics

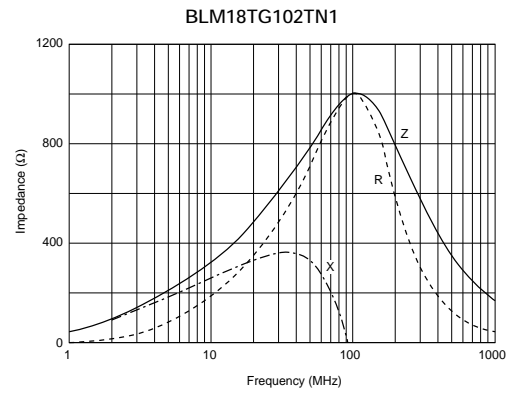

1

■ Features (BLM_B Series)

The chip ferrite beads BLM series is designed to function nearly as a resistor at noise frequencies, which greatly reduces the possibility of resonance and leaves signal wave forms undistorted.

BLM series is effective in circuits without stable ground lines because BLM series does not need a connection to ground.

The nickel barrier structure of the external electrodes provides excellent solder heat resistance. BLM_B series can minimize attenuation of the signal waveform due to its sharp impedance characteristics. Various impedances are available to match signal frequency.

The small size of BLM03B series (0.6x0.3mm) is suitable for advanced high-density mounting, and is followed on a miniaturization of digital equipment, or module of a functional portion.

■ Equivalent Circuit

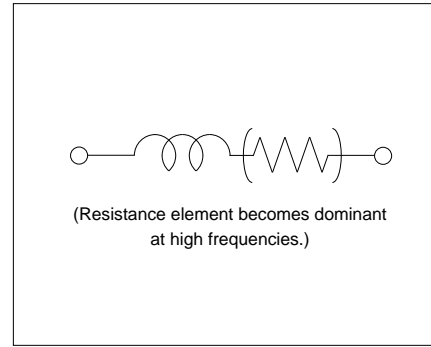

1

BLM03B Series (0201 Size)

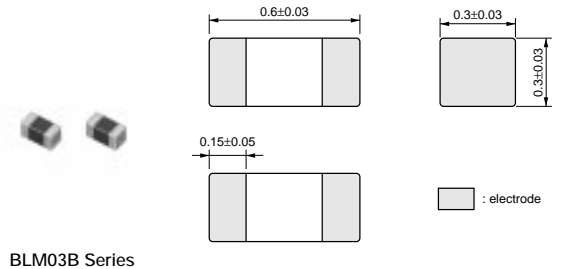

BLM03B Series

(in mm)

Part Number	Impedance (at 100MHz/20°C) (ohm)	Rated Current (mA)	DC Resistance (max.) (ohm)	Operating Temperature Range (°C)
BLM03BB100SN1	10 ±25%	300	0.4	-55 to +125
BLM03BB220SN1	22 ±25%	200	0.5	-55 to +125
BLM03BB470SN1	47 ±25%	200	0.7	-55 to +125
BLM03BB750SN1	75 ±25%	200	1.0	-55 to +125
BLM03BD750SN1	75 ±25%	300	0.4	-55 to +125
BLM03BB121SN1	120 ±25%	100	1.5	-55 to +125
BLM03BD121SN1	120 ±25%	250	0.5	-55 to +125
BLM03BD241SN1	240 ±25%	200	0.8	-55 to +125

■ Impedance - Frequency (Typical)

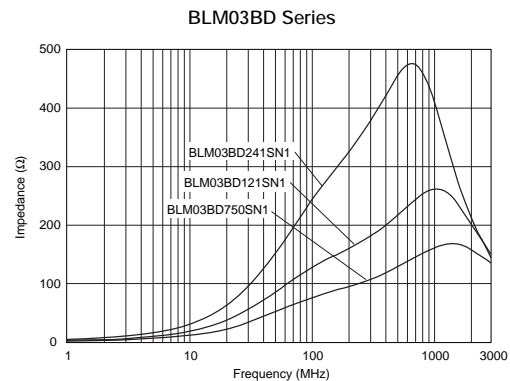
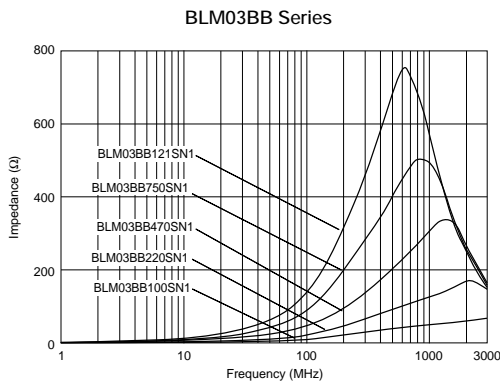

Continued on the following page. ↗

Continued from the preceding page.

Impedance - Frequency Characteristics

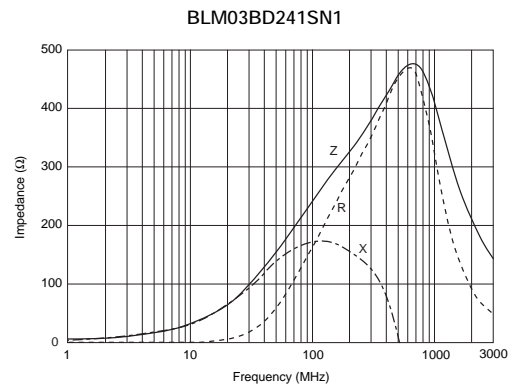
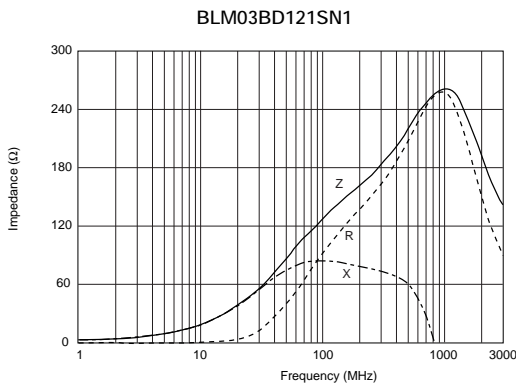
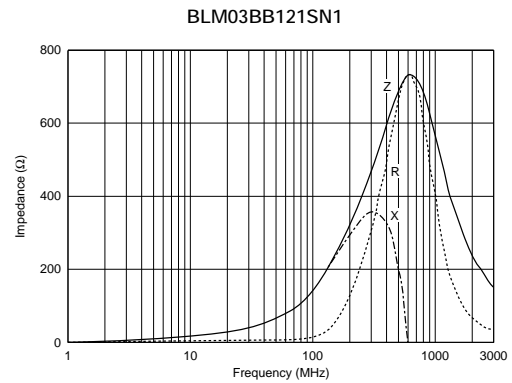
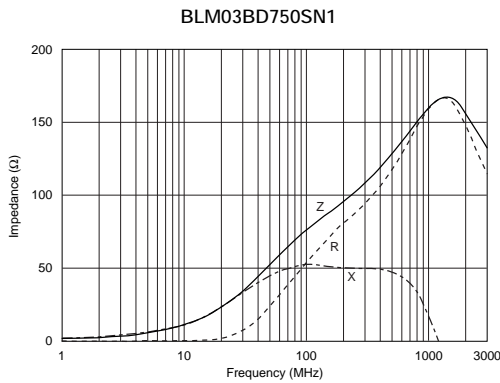
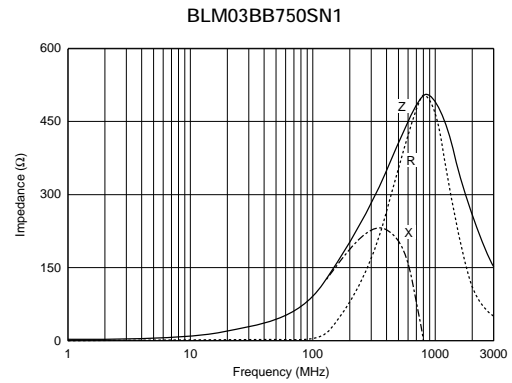
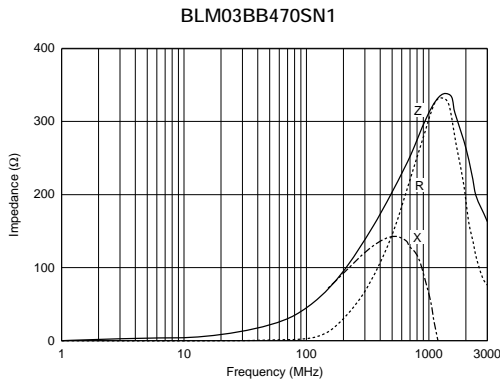
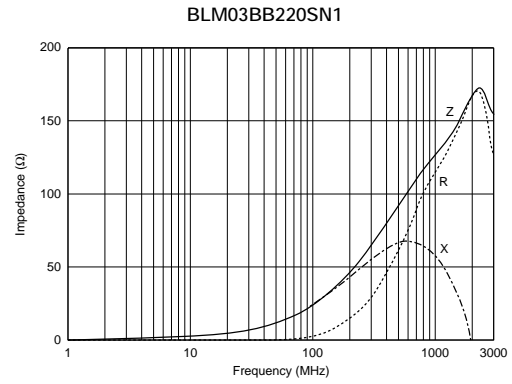
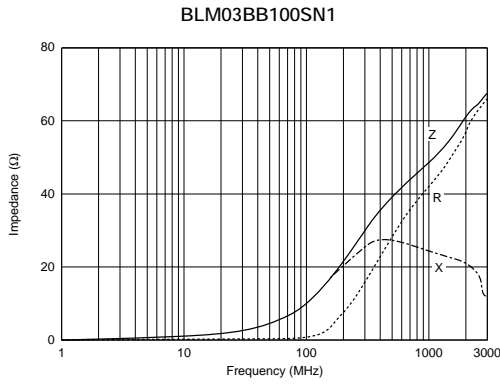

1

BLM15B Series (0402 Size)

1

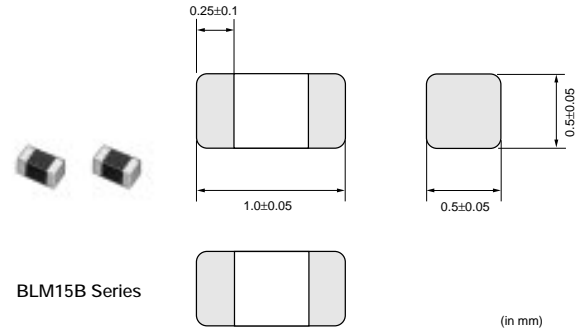

Part Number	Impedance (at 100MHz/20°C) (ohm)	Rated Current (mA)	DC Resistance (max.) (ohm)	Operating Temperature Range (°C)
BLM15BA050SN1	5 ±25%	300	0.10	-55 to +125
BLM15BB050SN1	5 ±25%	500	0.08	-55 to +125
BLM15BA100SN1	10 ±25%	300	0.20	-55 to +125
BLM15BB100SN1	10 ±25%	300	0.10	-55 to +125
BLM15BA220SN1	22 ±25%	300	0.30	-55 to +125
BLM15BB220SN1	22 ±25%	300	0.20	-55 to +125
BLM15BA330SN1	33 ±25%	300	0.40	-55 to +125
BLM15BA470SN1	47 ±25%	200	0.60	-55 to +125
BLM15BB470SN1	47 ±25%	300	0.35	-55 to +125
BLM15BA750SN1	75 ±25%	200	0.80	-55 to +125
BLM15BB750SN1	75 ±25%	300	0.40	-55 to +125
BLM15BD750SN1	75 ±25%	300	0.20	-55 to +125
BLM15BB121SN1	120 ±25%	300	0.55	-55 to +125
BLM15BD121SN1	120 ±25%	300	0.30	-55 to +125
BLM15BB221SN1	220 ±25%	200	0.80	-55 to +125
BLM15BD221SN1	220 ±25%	300	0.40	-55 to +125
BLM15BD471SN1	470 ±25%	200	0.60	-55 to +125
BLM15BD601SN1	600 ±25%	200	0.65	-55 to +125
BLM15BD102SN1	1000 ±25%	200	0.90	-55 to +125
BLM15BD182SN1	1800 ±25%	100	1.40	-55 to +125

■ Impedance - Frequency (Typical)

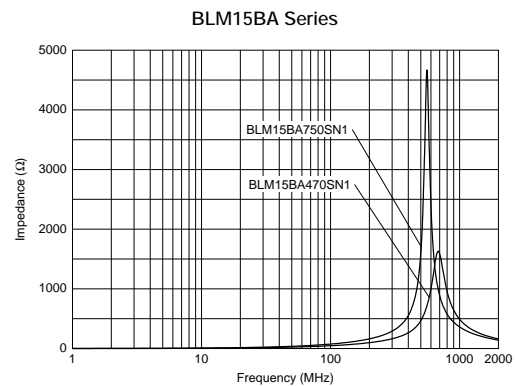

Continued on the following page. ↗

Continued from the preceding page.

Impedance - Frequency (Typical)

BLM15BB Series

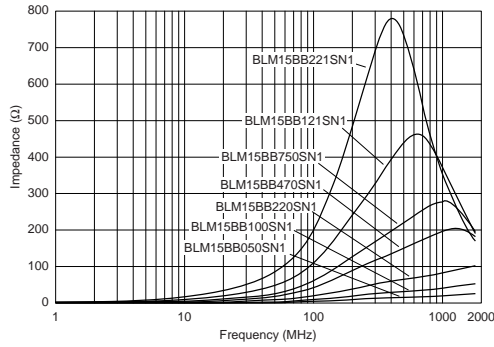

BLM15BD Series

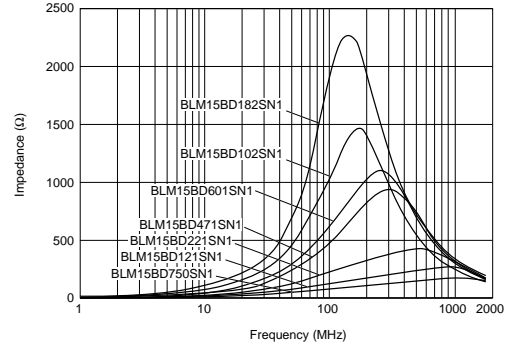

1

Impedance - Frequency Characteristics

BLM15BA050SN1

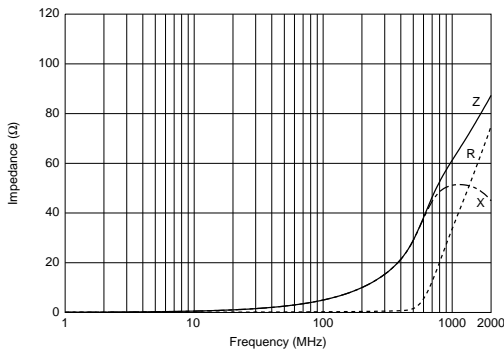

BLM15BB050SN1

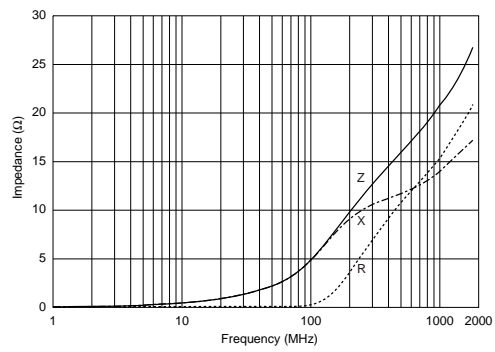

BLM15BA100SN1

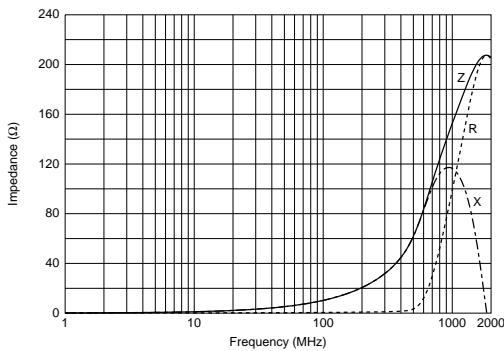

BLM15BB100SN1

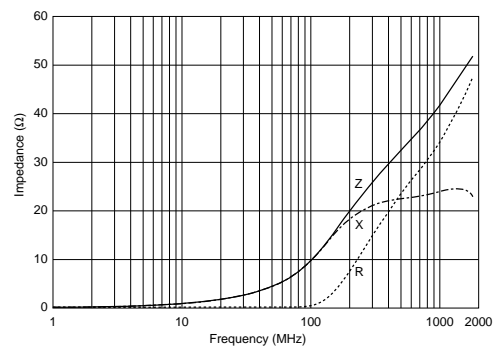

BLM15BA220SN1

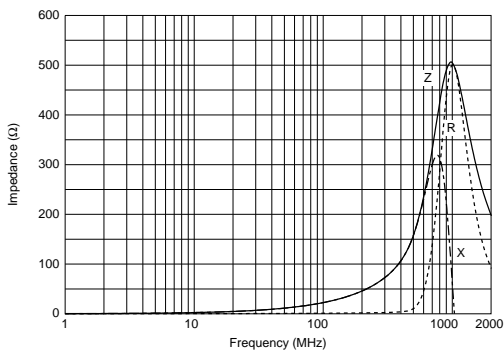

BLM15BB220SN1

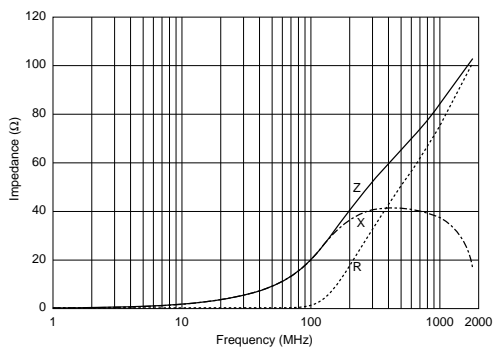

Continued on the following page. ↗

Continued from the preceding page.

Impedance - Frequency Characteristics

BLM15BA330SN1



BLM15BA470SN1

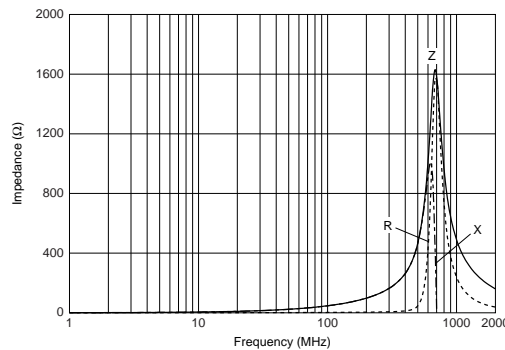

BLM15BB470SN1

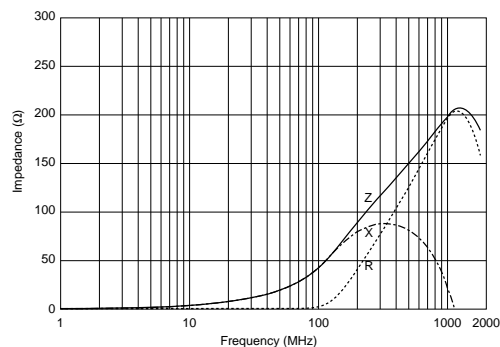

BLM15BA750SN1

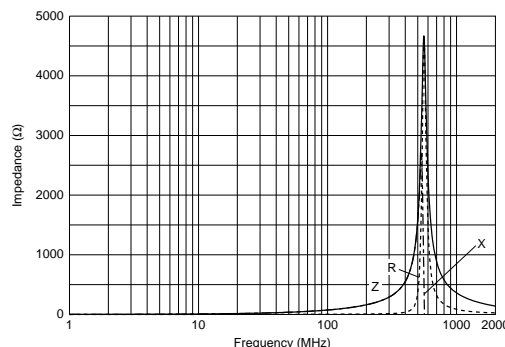

BLM15BB750SN1

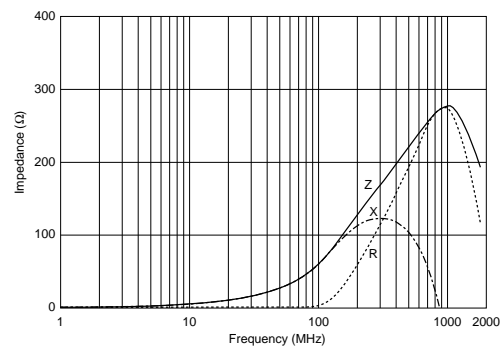

BLM15BD750SN1



BLM15BB121SN1

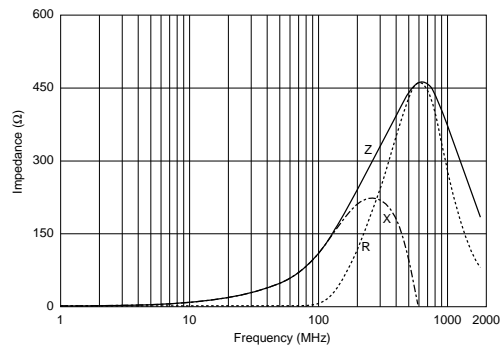

BLM15BD121SN1

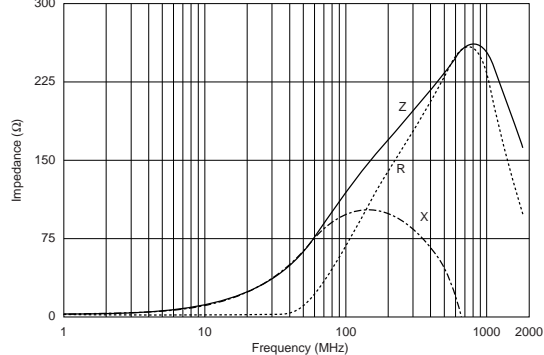

Continued on the following page. ↗

Continued from the preceding page.

Impedance - Frequency Characteristics

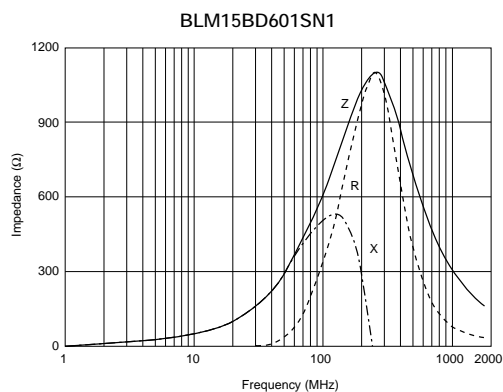
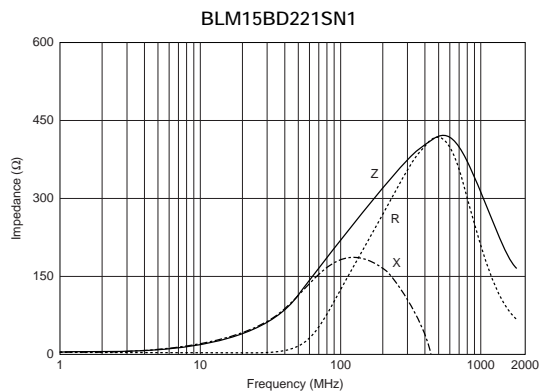

1

BLM18B Series (0603 Size)

1

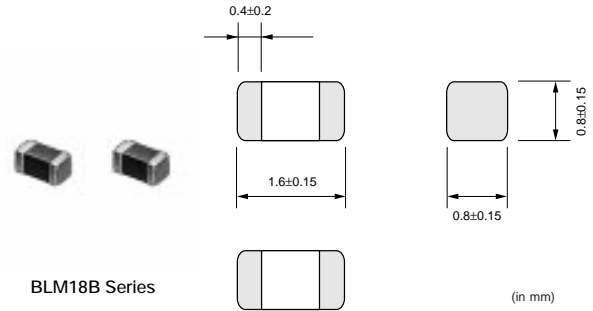

Part Number	Impedance (at 100MHz/20°C) (ohm)	Rated Current (mA)	DC Resistance (max.) (ohm)	Operating Temperature Range (°C)
BLM18BA050SN1	5 ±25%	500	0.20	-55 to +125
BLM18BB050SN1	5 ±25%	700	0.05	-55 to +125
BLM18BA100SN1	10 ±25%	500	0.25	-55 to +125
BLM18BB100SN1	10 ±25%	700	0.10	-55 to +125
BLM18BA220SN1	22 ±25%	500	0.35	-55 to +125
BLM18BB220SN1	22 ±25%	600	0.20	-55 to +125
BLM18BA470SN1	47 ±25%	300	0.55	-55 to +125
BLM18BB470SN1	47 ±25%	550	0.25	-55 to +125
BLM18BD470SN1	47 ±25%	500	0.30	-55 to +125
BLM18BB600SN1	60 ±25%	550	0.25	-55 to +125
BLM18BA750SN1	75 ±25%	300	0.70	-55 to +125
BLM18BB750SN1	75 ±25%	500	0.30	-55 to +125
BLM18BA121SN1	120 ±25%	200	0.90	-55 to +125
BLM18BB121SN1	120 ±25%	500	0.30	-55 to +125
BLM18BD121SN1	120 ±25%	200	0.40	-55 to +125
BLM18BB141SN1	140 ±25%	450	0.35	-55 to +125
BLM18BB151SN1	150 ±25%	450	0.37	-55 to +125
BLM18BD151SN1	150 ±25%	200	0.40	-55 to +125
BLM18BB221SN1	220 ±25%	450	0.45	-55 to +125
BLM18BD221SN1	220 ±25%	200	0.45	-55 to +125
BLM18BB331SN1	330 ±25%	400	0.58	-55 to +125
BLM18BD331SN1	330 ±25%	200	0.50	-55 to +125
BLM18BD421SN1	420 ±25%	200	0.55	-55 to +125
BLM18BB471SN1	470 ±25%	300	0.85	-55 to +125
BLM18BD471SN1	470 ±25%	200	0.55	-55 to +125
BLM18BD601SN1	600 ±25%	200	0.65	-55 to +125
BLM18BD102SN1	1000 ±25%	100	0.85	-55 to +125
BLM18BD152SN1	1500 ±25%	50	1.20	-55 to +125
BLM18BD182SN1	1800 ±25%	50	1.50	-55 to +125
BLM18BD222SN1	2200 ±25%	50	1.50	-55 to +125
BLM18BD252SN1	2500 ±25%	50	1.50	-55 to +125

■ Impedance - Frequency (Typical)

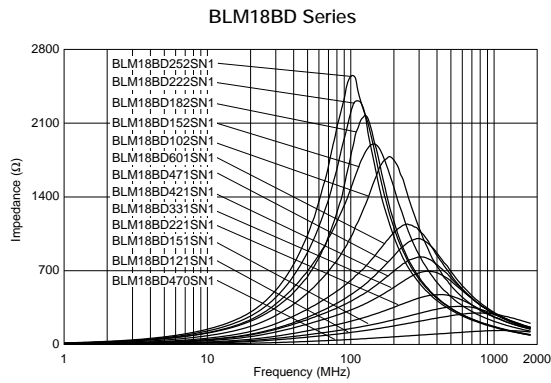
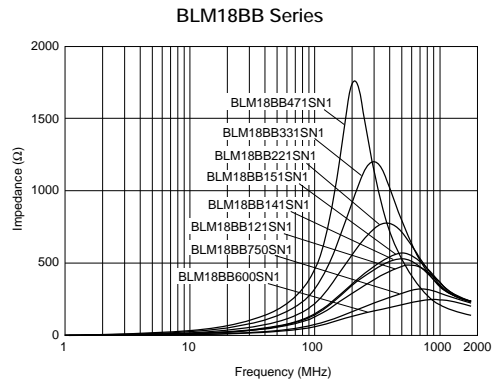
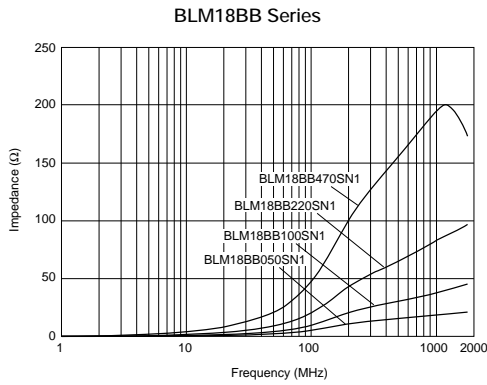
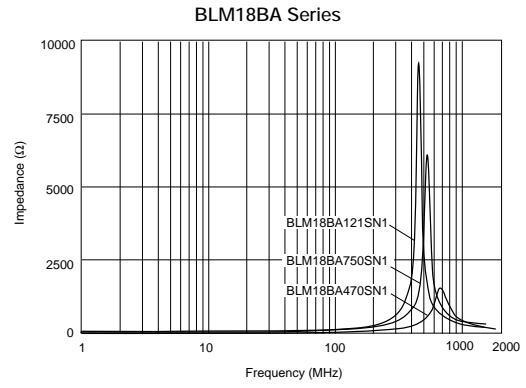
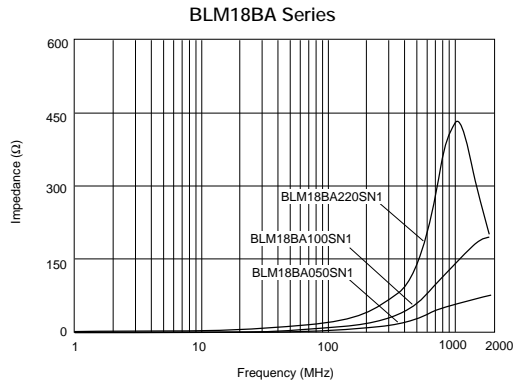

■ Impedance - Frequency Characteristics

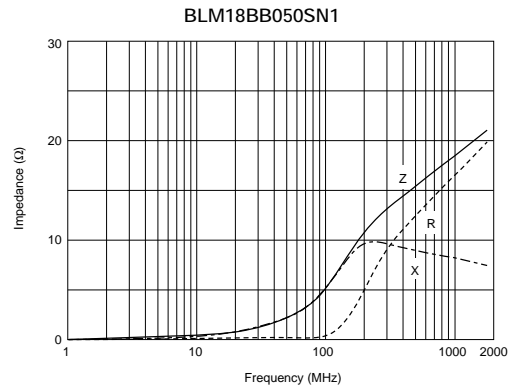
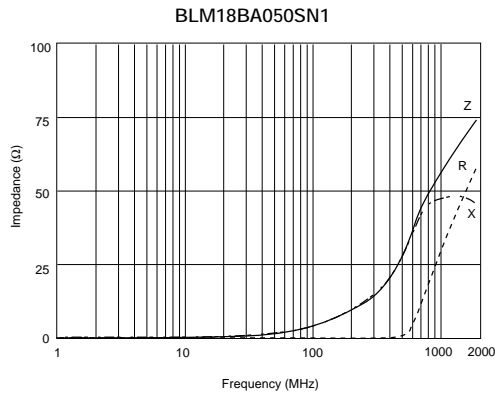

Continued on the following page. ↗

Continued from the preceding page.

■ Impedance - Frequency Characteristics

BLM18BA100SN1



BLM18BB100SN1



BLM18BA220SN1

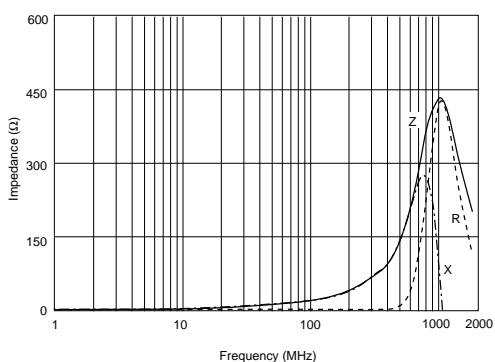

BLM18BB220SN1

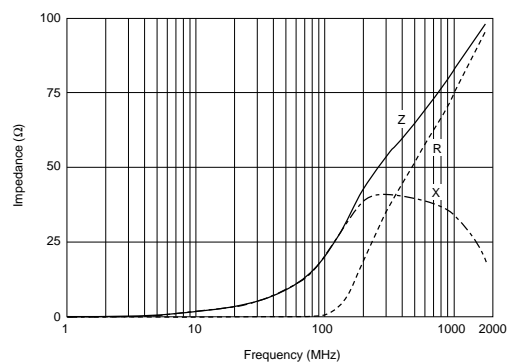

BLM18BA470SN1



BLM18BB470SN1



BLM18BD470SN1



BLM18BB600SN1

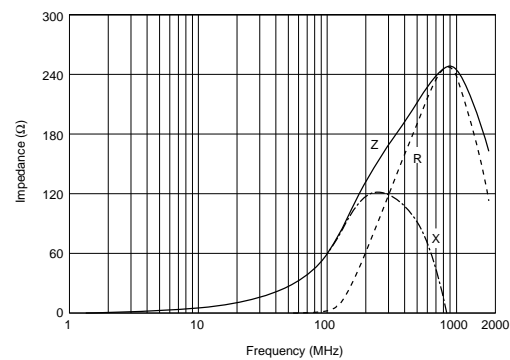

1

Continued from the preceding page.

Impedance - Frequency Characteristics

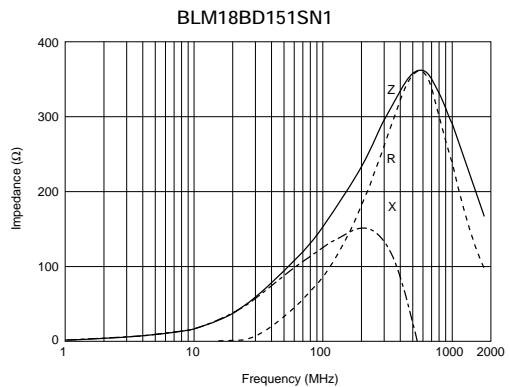
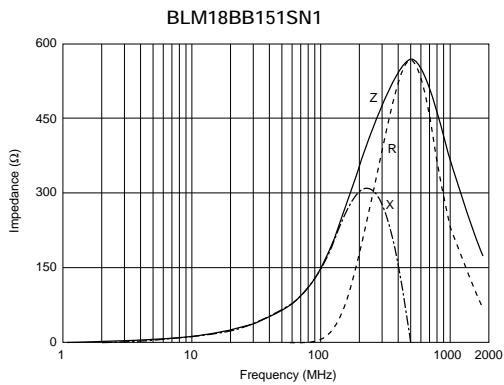
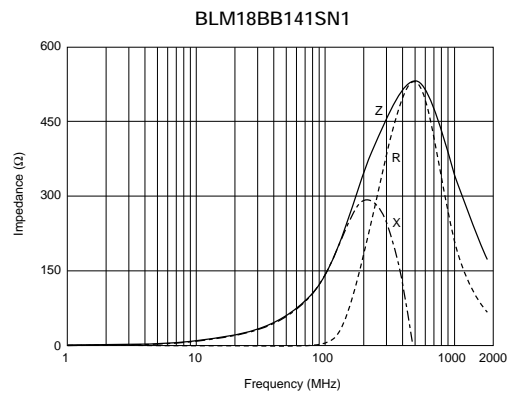
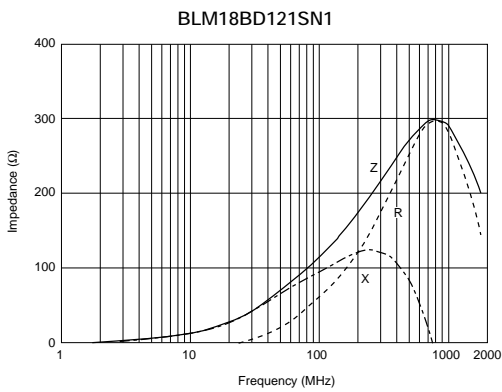
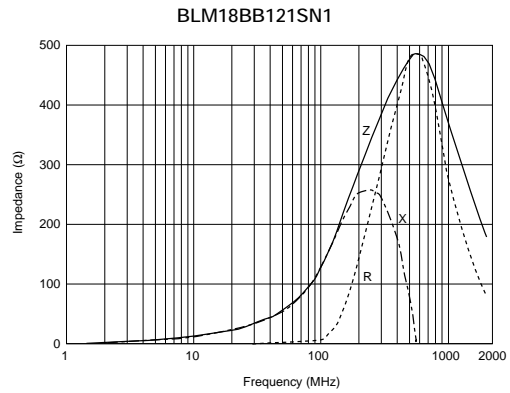
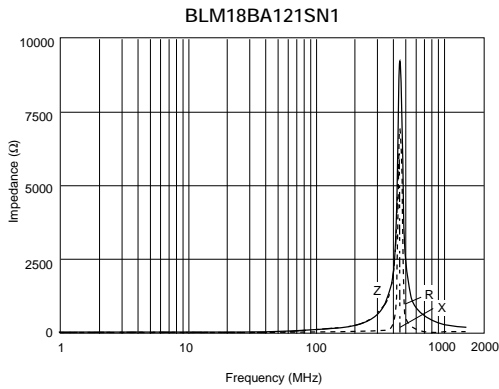
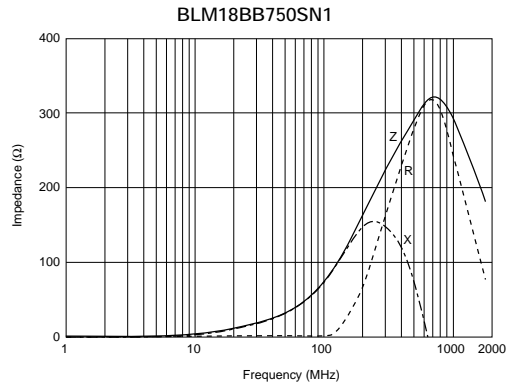
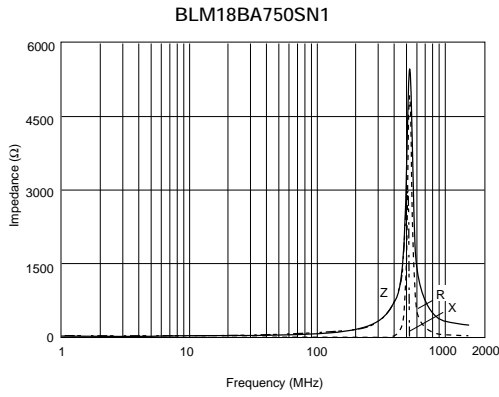

1

Continued on the following page. ↗

Continued from the preceding page.

Impedance - Frequency Characteristics

1

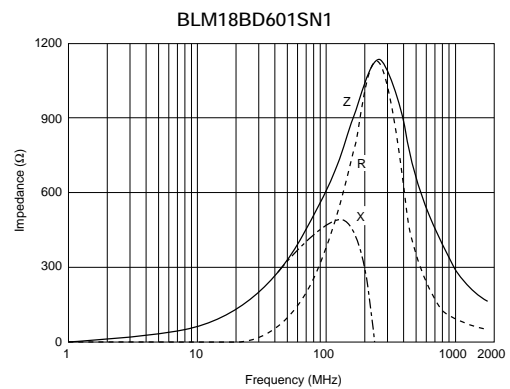
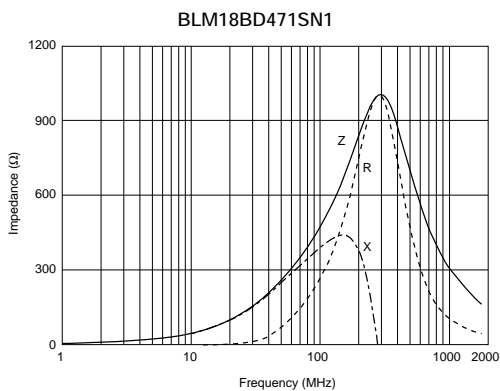
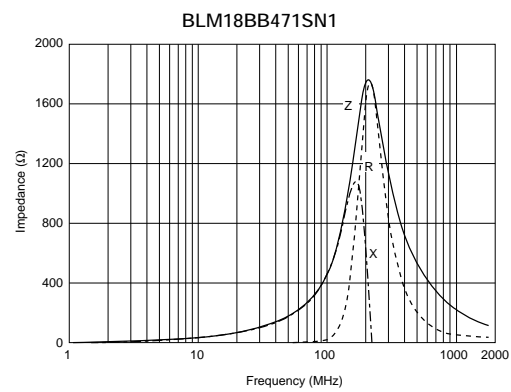
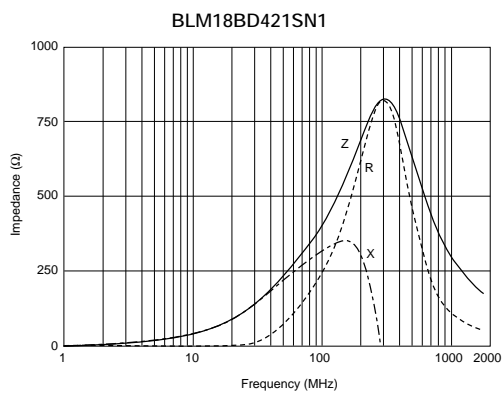
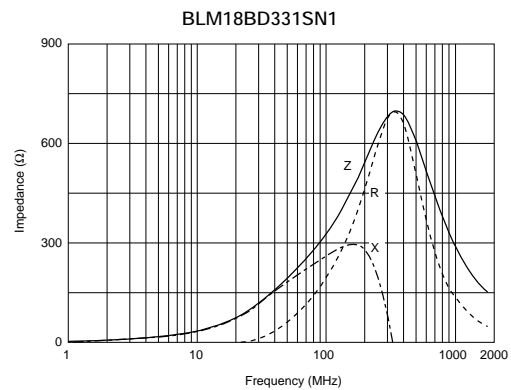
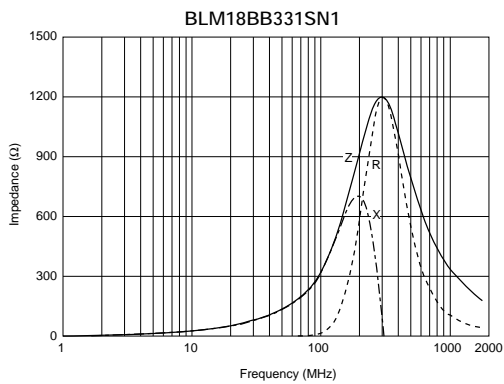
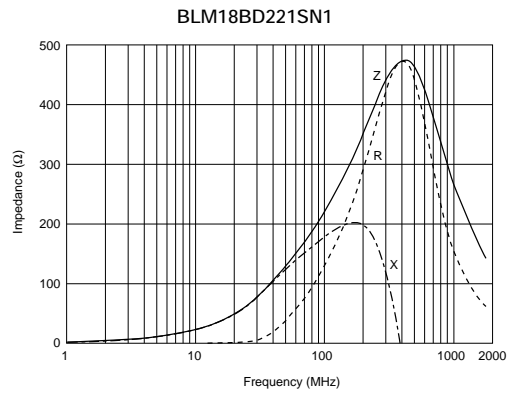
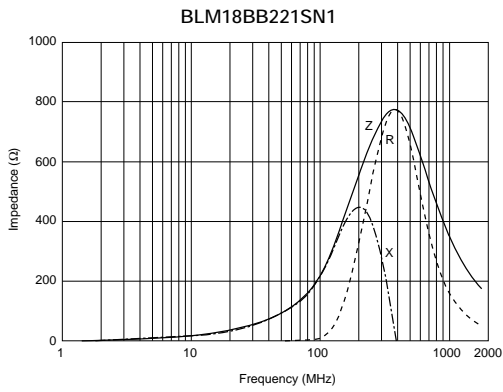

Continued on the following page. ↗

Continued from the preceding page.

Impedance - Frequency Characteristics

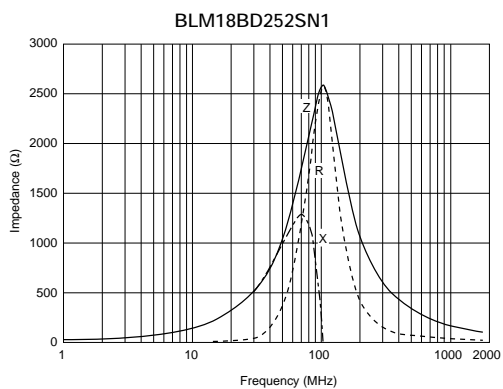
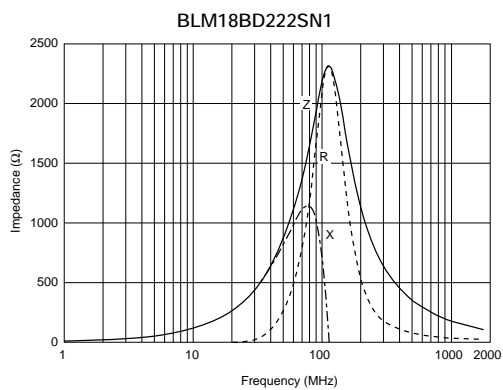
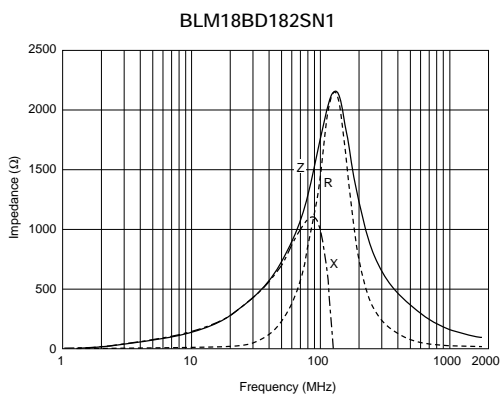
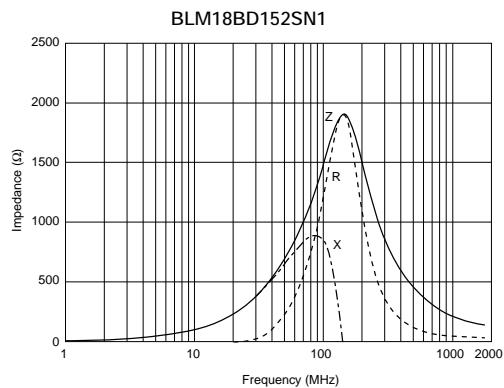

1

BLM21B Series (0805 Size)

1



Part Number	Impedance (at 100MHz/20°C) (ohm)	Rated Current (mA)	DC Resistance (max.) (ohm)	Operating Temperature Range (°C)
BLM21BB050SN1	5 ±25%	500	0.07	-55 to +125
BLM21BB600SN1	60 ±25%	200	0.20	-55 to +125
BLM21BB750SN1	75 ±25%	200	0.25	-55 to +125
BLM21BB121SN1	120 ±25%	200	0.25	-55 to +125
BLM21BD121SN1	120 ±25%	200	0.25	-55 to +125
BLM21BB151SN1	150 ±25%	200	0.25	-55 to +125
BLM21BD151SN1	150 ±25%	200	0.25	-55 to +125
BLM21BB201SN1	200 ±25%	200	0.35	-55 to +125
BLM21BB221SN1	220 ±25%	200	0.35	-55 to +125
BLM21BD221SN1	220 ±25%	200	0.25	-55 to +125
BLM21BB331SN1	330 ±25%	200	0.40	-55 to +125
BLM21BD331SN1	330 ±25%	200	0.30	-55 to +125
BLM21BD421SN1	420 ±25%	200	0.30	-55 to +125
BLM21BB471SN1	470 ±25%	200	0.45	-55 to +125
BLM21BD471SN1	470 ±25%	200	0.35	-55 to +125
BLM21BD601SN1	600 ±25%	200	0.35	-55 to +125
BLM21BD751SN1	750 ±25%	200	0.40	-55 to +125
BLM21BD102SN1	1000 ±25%	200	0.40	-55 to +125
BLM21BD152SN1	1500 ±25%	200	0.45	-55 to +125
BLM21BD182SN1	1800 ±25%	200	0.50	-55 to +125
BLM21BD222TN1	2200 ±25%	200	0.60	-55 to +125
BLM21BD222SN1	2250 (Typ.)	200	0.60	-55 to +125
BLM21BD272SN1	2700 ±25%	200	0.80	-55 to +125

■ Impedance - Frequency (Typical)



Continued on the following page. ↗

Continued from the preceding page.

Impedance - Frequency Characteristics

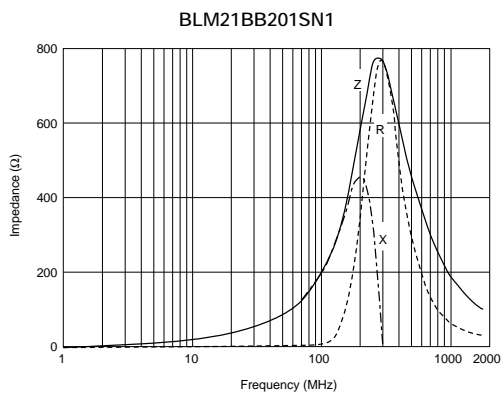
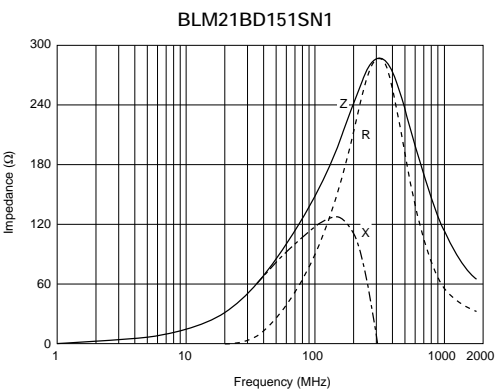
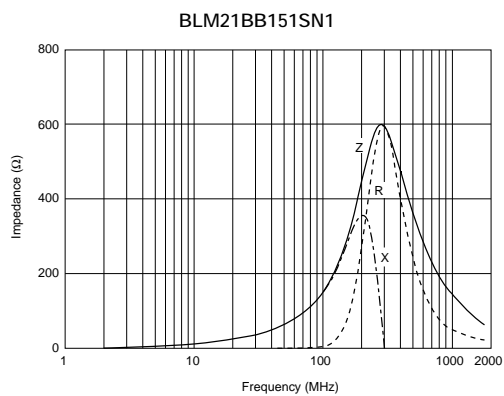
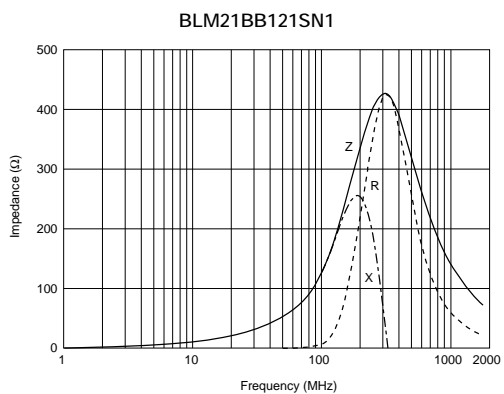
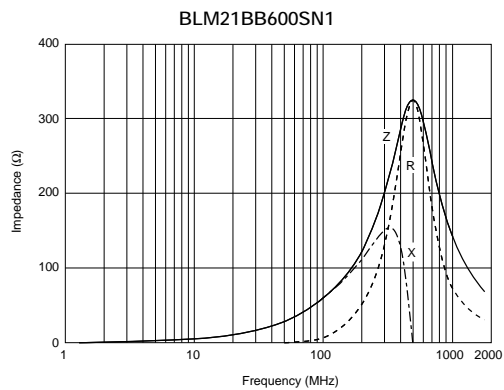

1

Continued on the following page. ↗

Continued from the preceding page.

Impedance - Frequency Characteristics

1

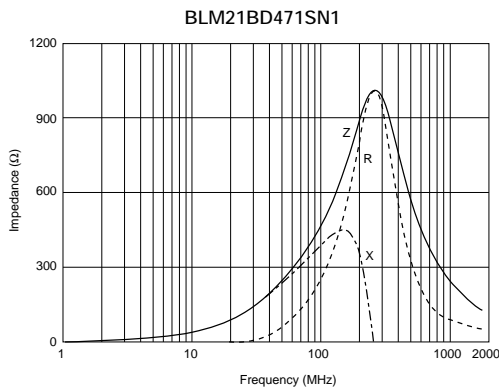
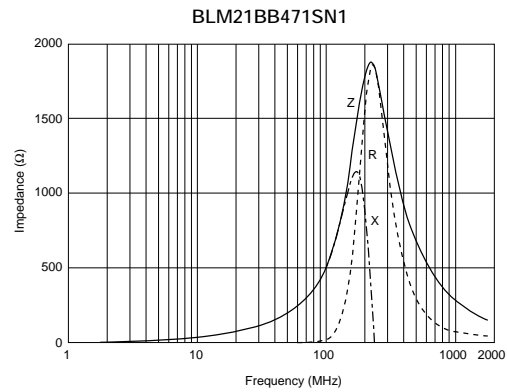
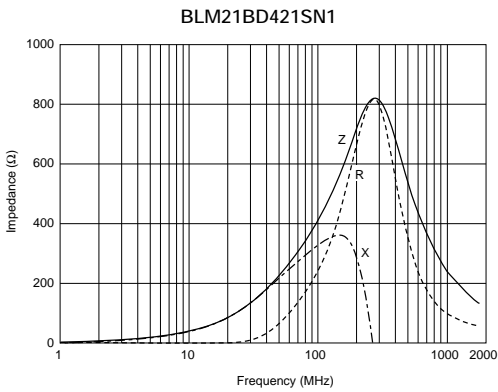
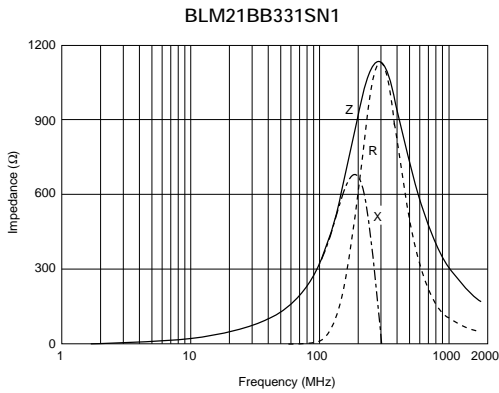
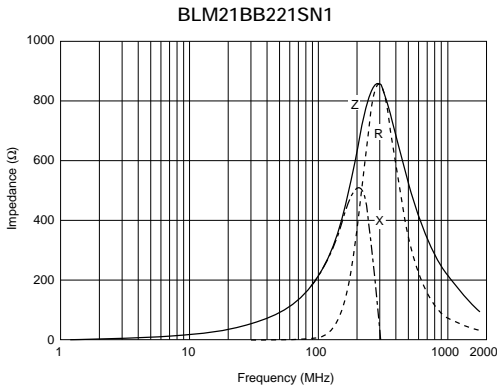

Continued on the following page. ↗

Continued from the preceding page.

■ Impedance - Frequency Characteristics

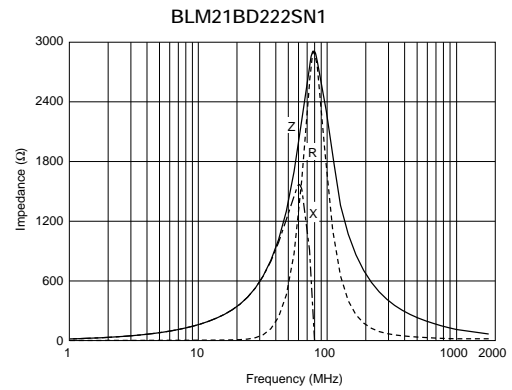
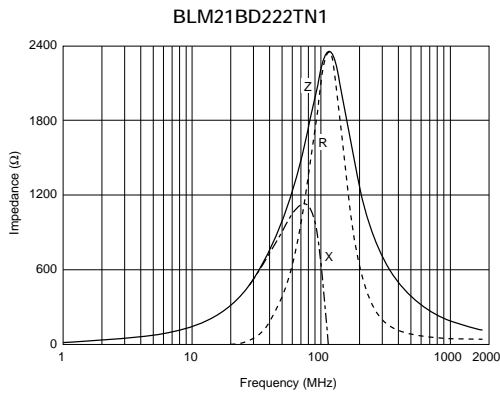
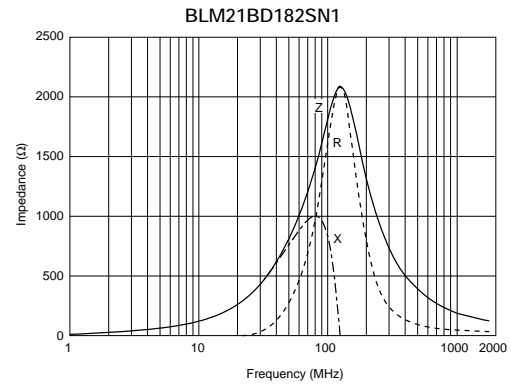
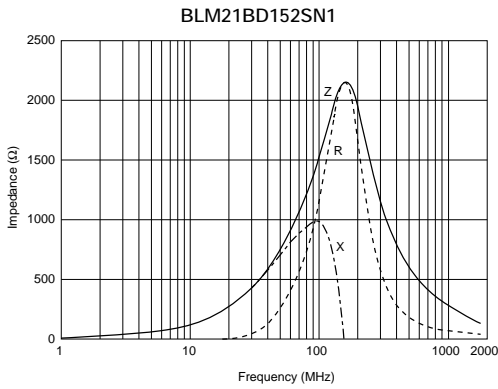
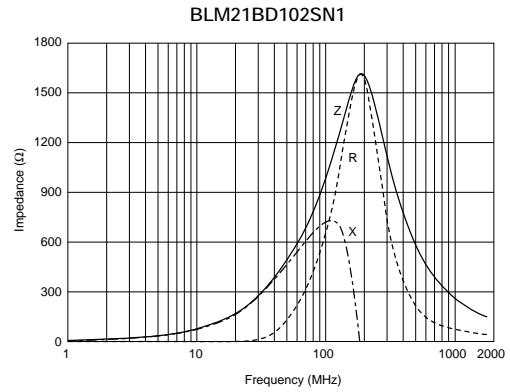

1

■ Features (BLM_R Series)

The chip ferrite beads BLM series is designed to function nearly as a resistor at noise frequencies, which greatly reduces the possibility of resonance and leaves signal wave forms undistorted.

BLM series is effective in circuits without stable ground lines because BLM series does not need a connection to ground.

The nickel barrier structure of the external electrodes provides excellent solder heat resistance. BLM_R series can be used in a digital Interface. Resistance of BLM_R series especially grows in the lower frequency range. Therefore BLM_R series is less effective for digital signal waveform at low frequency range and can suppress the ringing.

■ Equivalent Circuit

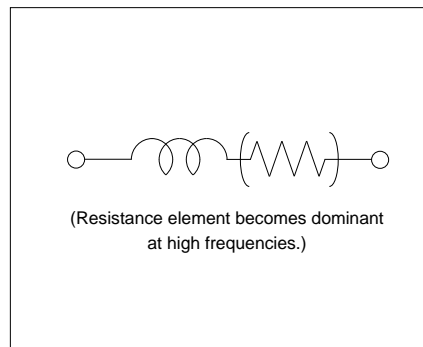

1

BLM18R Series (0603 Size)

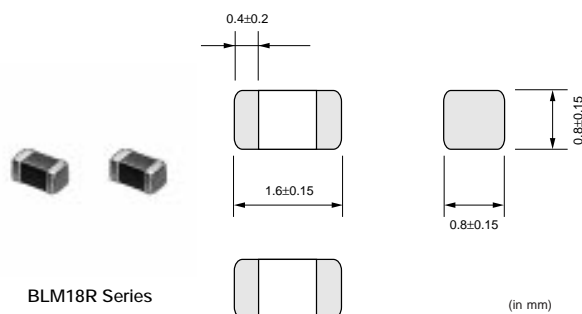

Part Number	Impedance (at 100MHz/20°C) (ohm)	Rated Current (mA)	DC Resistance (max.) (ohm)	Operating Temperature Range (°C)
BLM18RK121SN1	120 ±25%	200	0.25	-55 to +125
BLM18RK221SN1	220 ±25%	200	0.30	-55 to +125
BLM18RK471SN1	470 ±25%	200	0.50	-55 to +125
BLM18RK601SN1	600 ±25%	200	0.60	-55 to +125
BLM18RK102SN1	1000 ±25%	200	0.80	-55 to +125

■ Impedance - Frequency (Typical)

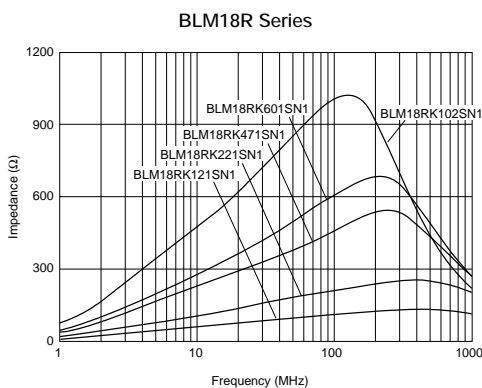

■ Impedance - Frequency Characteristics

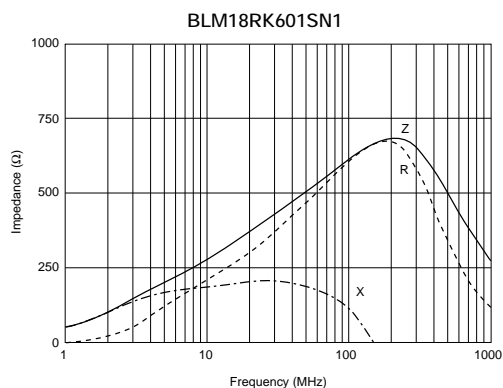
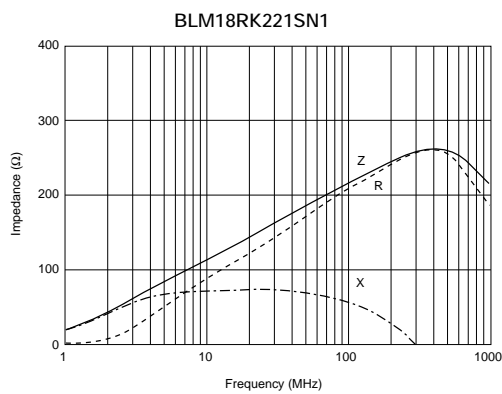
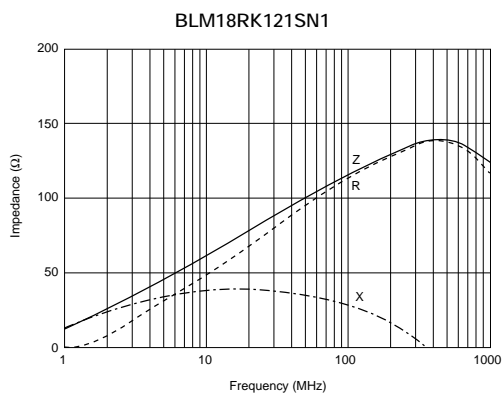

1

BLM21R Series (0805 Size)

1

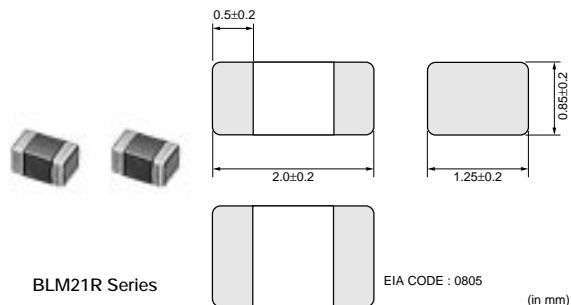

Part Number	Impedance (at 100MHz/20°C) (ohm)	Rated Current (mA)	DC Resistance (max.) (ohm)	Operating Temperature Range (°C)
BLM21RK121SN1	120 ±25%	200	0.15	-55 to +125
BLM21RK221SN1	220 ±25%	200	0.20	-55 to +125
BLM21RK471SN1	470 ±25%	200	0.25	-55 to +125
BLM21RK601SN1	600 ±25%	200	0.30	-55 to +125
BLM21RK102SN1	1000 ±25%	200	0.50	-55 to +125

■ Impedance - Frequency (Typical)

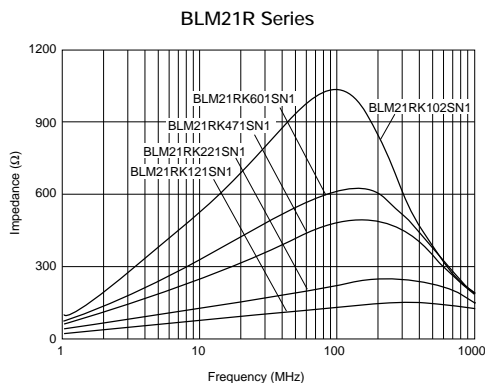

■ Impedance - Frequency Characteristics

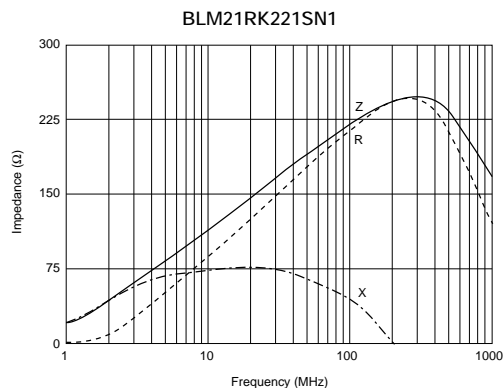
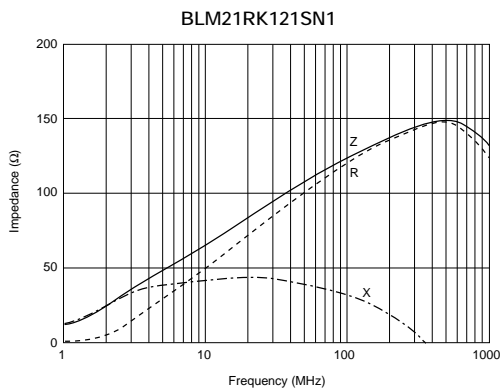

Continued on the following page. ↗

Continued from the preceding page.

■ Impedance - Frequency Characteristics

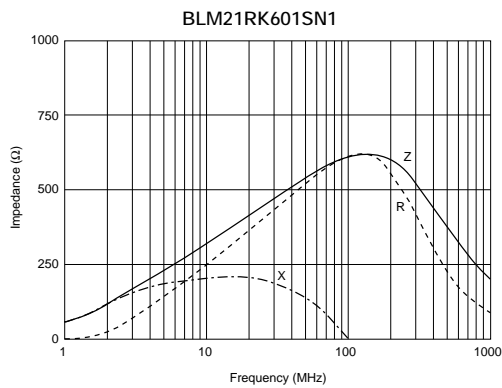

1

Noise Suppression Effect of BLM_R Series

Waveform Distortion Suppressing Performance of BLM□□R Series

1



Type of Filter	EMI Suppression Effect / Description		
<p>Initial (No filter)</p>	<p>Signal waveform (100nsec/div, 2V/div)</p>	<p>Expand (10nsec/div, 2V/div)</p>	<p>Spectrum</p> <p>Ringing is caused on the signal waveform. Such ringing contains several hundred MHz harmonic components and generates noise.</p>
<p>Resistor (47Ω) is used</p>	<p>Signal waveform (100nsec/div, 2V/div)</p>	<p>Expand (10nsec/div, 2V/div)</p>	<p>Spectrum</p> <p>Comparing initial waveform, ringing is suppressed a little. However there still remains high level waveform distortion.</p>
<p>BLM18RK221SN1 (220Ω at 100MHz) is used</p>	<p>Signal waveform (100nsec/div, 2V/div)</p>	<p>Expand (10nsec/div, 2V/div)</p>	<p>Spectrum</p> <p>BLM18R has excellent performance for noise suppression and waveform distortion suppression. BLM18R suppresses drastically not only spectrum level in more than 100MHz range but waveform distortion.</p>

■ Features (BLM_P Series)

The chip ferrite beads BLM series is designed to function nearly as a resistor at noise frequencies, which greatly reduces the possibility of resonance and leaves signal wave forms undistorted.

BLM series is effective in circuits without stable ground lines because BLM series does not need a connection to ground.

The nickel barrier structure of the external electrodes provides excellent solder heat resistance. BLM_P series can be used in high current circuits due to its low DC resistance. It can match power lines to a maximum of 6A DC.

The small size of BLM03A series (0.6x0.3mm) is suitable for noise suppression in small equipment such as PA modules for cellular phones.

■ Equivalent Circuit

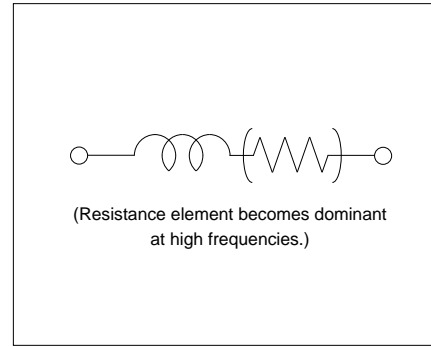

1

BLM03P Series (0201 Size)



Part Number	Impedance (at 100MHz/20°C) (ohm)	Rated Current (mA)	DC Resistance (max.) (ohm)	Operating Temperature Range (°C)
BLM03PG220SN1	22 ±25%	900	0.065	-55 to +125
BLM03PG330SN1	33 ±25%	750	0.090	-55 to +125

■ Impedance - Frequency (Typical)



■ Impedance - Frequency Characteristics

BLM03PG220SN1



BLM03PG330SN1



1

BLM15P Series (0402 Size)

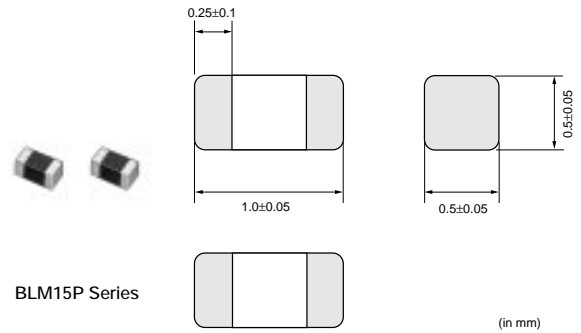

Part Number	Impedance (at 100MHz/20°C) (ohm)	Rated Current (mA)	DC Resistance (max.) (ohm)	Operating Temperature Range (°C)
BLM15PG100SN1	10 (Typ.)	1000	0.05	-55 to +125
BLM15PD300SN1	30 ±25%	2200	0.035	-55 to +125
BLM15PD600SN1	60 ±25%	1700	0.06	-55 to +125
BLM15PD800SN1	80 ±25%	1500	0.07	-55 to +125
BLM15PD121SN1	120 ±25%	1300	0.09	-55 to +125

In operating temperature exceeding +85°C, derating of current is necessary for BLM15PD series. Please refer to p.57, "Derating of Rated Current".

■ Impedance - Frequency (Typical)

BLM15P Series



■ Impedance - Frequency Characteristics

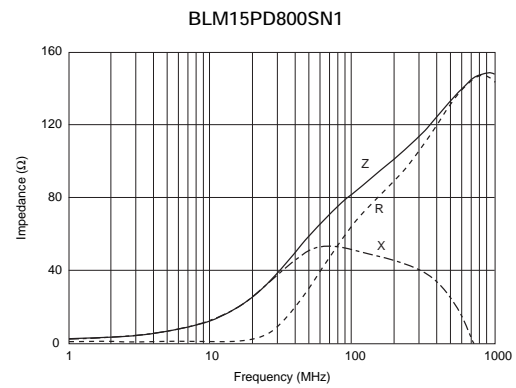
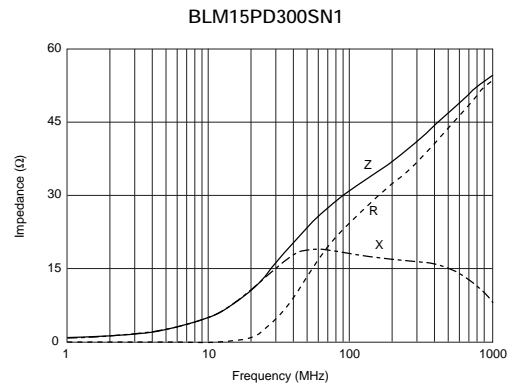

■ Notice (Rating)

In operating temperature exceeding +85°C, derating of current is necessary for BLM15PD series.
 Please apply the derating curve shown in chart according to the operating temperature.



1

BLM18P Series (0603 Size)

1

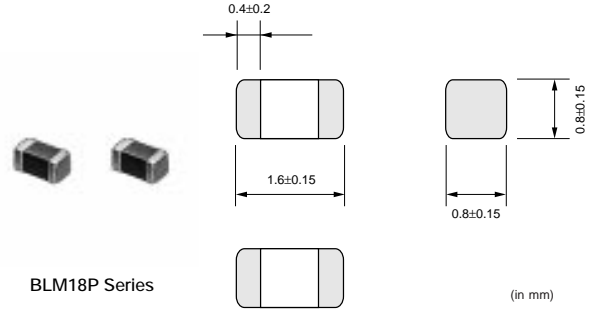

Part Number	Impedance (at 100MHz/20°C) (ohm)	Rated Current (mA)	DC Resistance (max.) (ohm)	Operating Temperature Range (°C)
BLM18PG300SN1	30 (Typ.)	1000	0.05	-55 to +125
BLM18PG330SN1	33 ±25%	3000	0.025	-55 to +125
BLM18PG600SN1	60 (Typ.)	500	0.10	-55 to +125
BLM18PG121SN1	120 ±25%	2000	0.05	-55 to +125
BLM18PG181SN1	180 ±25%	1500	0.09	-55 to +125
BLM18PG221SN1	220 ±25%	1400	0.10	-55 to +125
BLM18PG331SN1	330 ±25%	1200	0.15	-55 to +125
BLM18PG471SN1	470 ±25%	1000	0.20	-55 to +125

For the items of rated current higher than 1200mA, derating is required. Please refer to p.68, "Derating of Rated Current".

■ Impedance - Frequency (Typical)

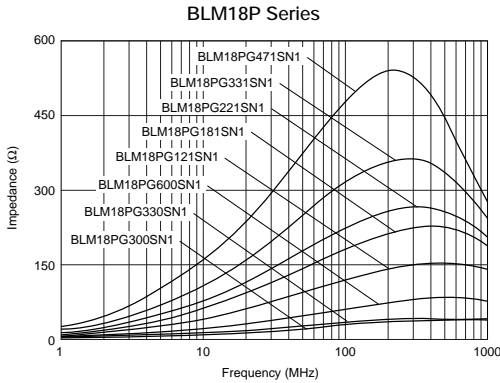

■ Impedance - Frequency Characteristics

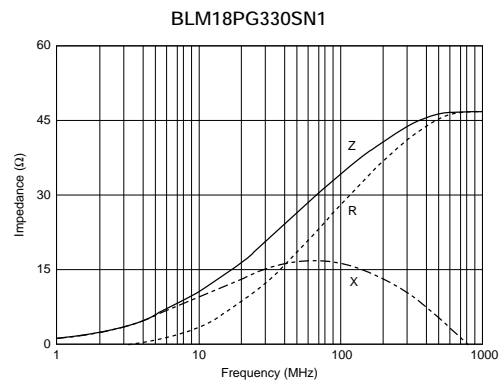
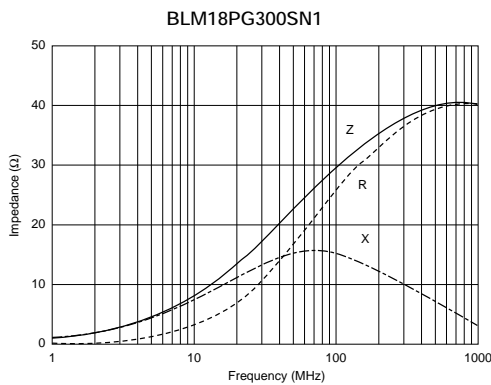

Continued on the following page. ↗

Continued from the preceding page.

Impedance - Frequency Characteristics

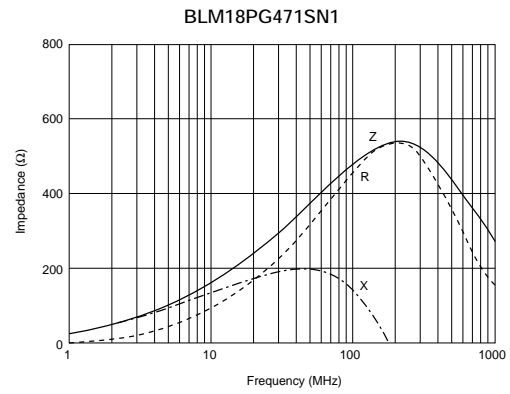
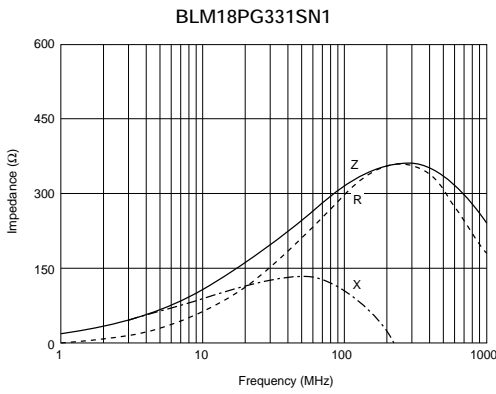
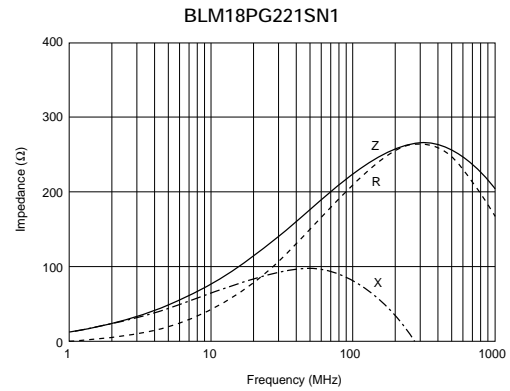
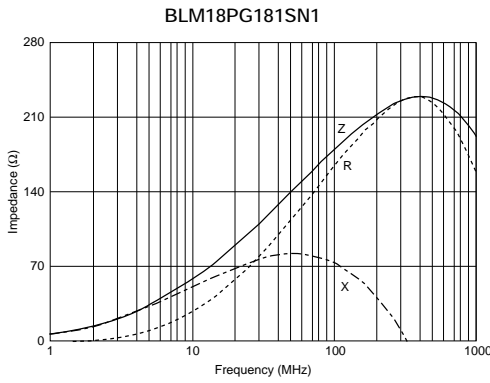
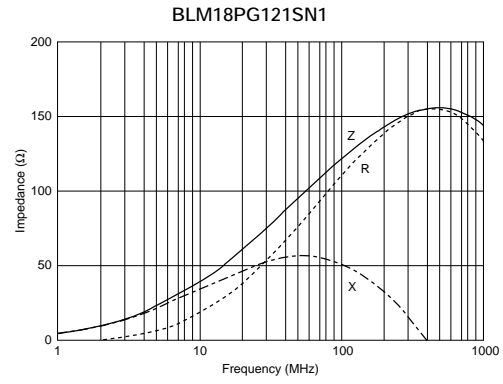
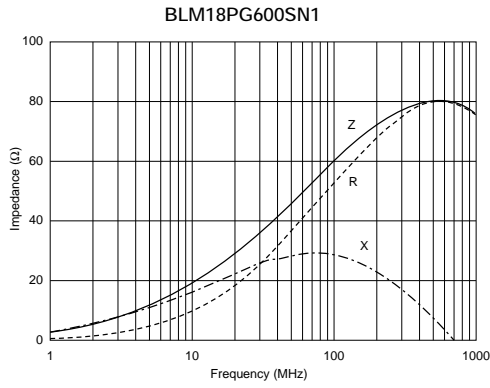

1

BLM21P Series (0805 Size)

1



Part Number	Impedance (at 100MHz/20°C) (ohm)	Rated Current (mA)	DC Resistance (max.) (ohm)	Operating Temperature Range (°C)
BLM21PG220SN1	22 ±25%	6000	0.01	-55 to +125
BLM21PG300SN1	30 (Typ.)	3000	0.015	-55 to +125
BLM21PG600SN1	60 ±25%	3000	0.025	-55 to +125
BLM21PG221SN1	220 ±25%	2000	0.050	-55 to +125
BLM21PG331SN1	330 ±25%	1500	0.09	-55 to +125

For the items of rated current higher than 1500mA, derating is required.
Please refer to p.68, "Derating of Rated Current".

■ Impedance - Frequency (Typical)

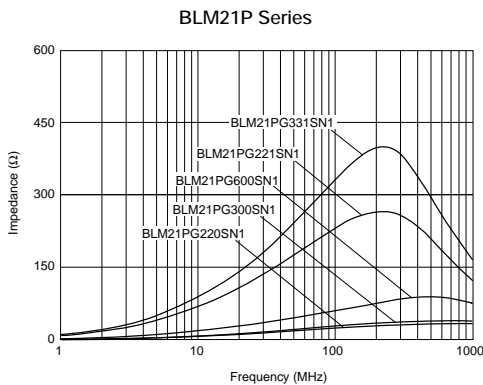

■ Impedance - Frequency Characteristics

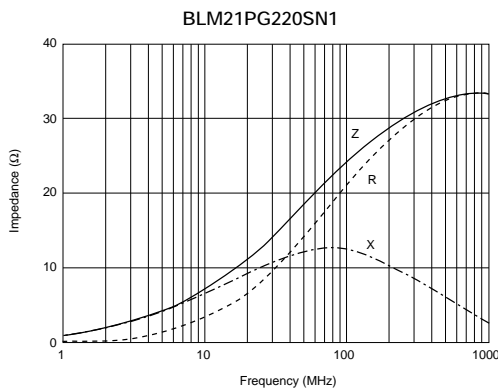

Continued on the following page. ↗

Continued from the preceding page.

Impedance - Frequency Characteristics

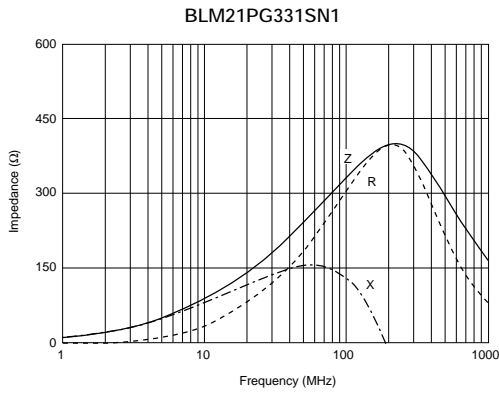
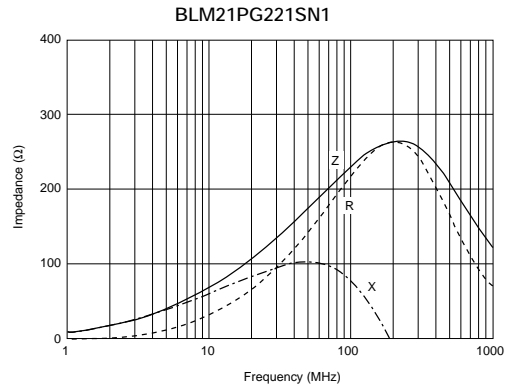
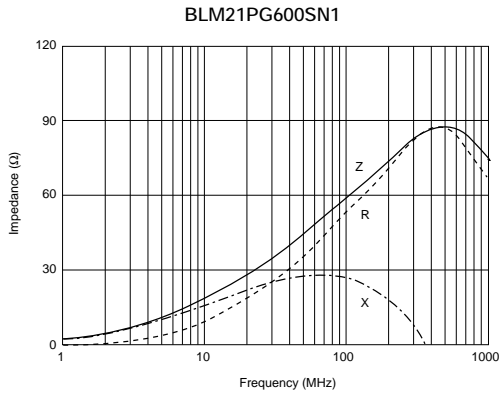

1

BLM31P Series (1206 Size)

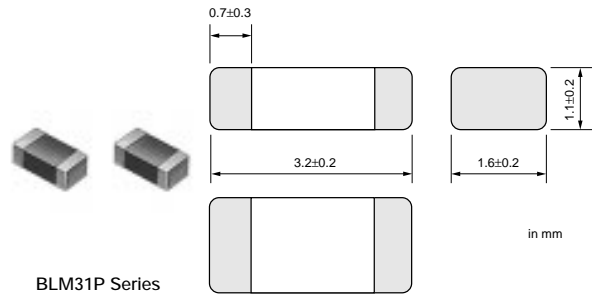

Part Number	Impedance (at 100MHz/20°C) (ohm)	Rated Current (mA)	DC Resistance (max.) (ohm)	Operating Temperature Range (°C)
BLM31PG330SN1	33 ±25%	6000	0.01	-55 to +125
BLM31PG500SN1	50 (Typ.)	3000	0.025	-55 to +125
BLM31PG121SN1	120 ±25%	3000	0.025	-55 to +125
BLM31PG391SN1	390 ±25%	2000	0.05	-55 to +125
BLM31PG601SN1	600 ±25%	1500	0.09	-55 to +125

For the items of rated current higher than 1500mA, derating is required. Please refer to p.68, "Derating of Rated Current".

■ Impedance - Frequency (Typical)

BLM31P Series

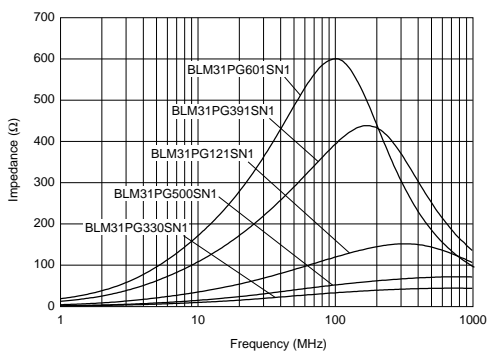

1

■ Impedance - Frequency Characteristics

BLM31PG330SN1

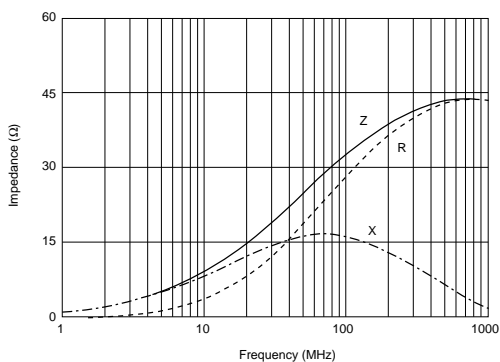

BLM31PG500SN1



BLM31PG121SN1

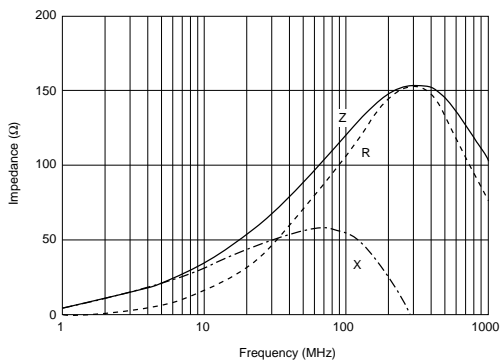

BLM31PG391SN1



BLM31PG601SN1

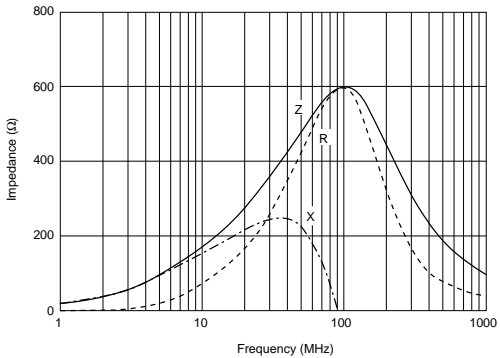

BLM41P Series (1806 Size)



1

Part Number	Impedance (at 100MHz/20°C) (ohm)	Rated Current (mA)	DC Resistance (max.) (ohm)	Operating Temperature Range (°C)
BLM41PG600SN1	60 (Typ.)	6000	0.01	-55 to +125
BLM41PG750SN1	75 (Typ.)	3000	0.025	-55 to +125
BLM41PG181SN1	180 ±25%	3000	0.025	-55 to +125
BLM41PG471SN1	470 ±25%	2000	0.05	-55 to +125
BLM41PG102SN1	1000 ±25%	1500	0.09	-55 to +125

For the items of rated current higher than 1500mA, derating is required. Please refer to p.68, "Derating of Rated Current".

■ Impedance - Frequency (Typical)

BLM41P Series (60-180ohm)



BLM41P Series (470-1000ohm)

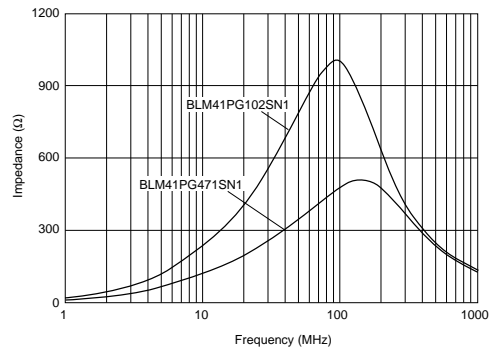

■ Impedance - Frequency Characteristics

BLM41PG600SN1



BLM41PG750SN1



Continued on the following page. ↗

Continued from the preceding page.

Impedance - Frequency Characteristics

BLM41PG181SN1



BLM41PG471SN1



BLM41PG102SN1

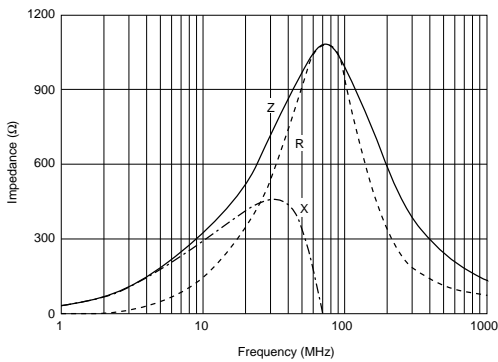

BLM18K Series (0603 Size)

Features

The chip ferrite beads BLM series is designed to function nearly as a resistor at noise frequencies, which greatly reduces the possibility of resonance and leaves signal wave forms undistorted.

BLM series is effective in circuits without stable ground lines because BLM series does not need a connection to ground.

The nickel barrier structure of the external electrodes provides excellent solder heat resistance. BLM_K series can be used in high current circuits due to its low DC resistance. It can match power lines to a maximum of 6A DC.

Equivalent Circuit

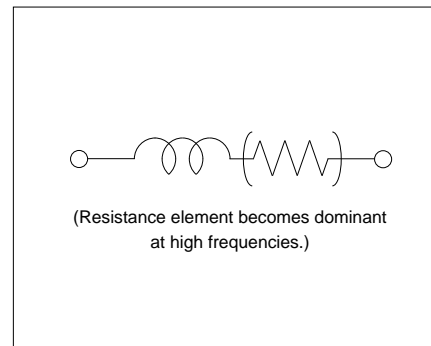

Part Number	Impedance (at 100MHz/20°C) (ohm)	Rated Current (mA)	DC Resistance (max.) (ohm)	Operating Temperature Range (°C)
BLM18KG260TN1	26 ±25%	6000	0.007	-55 to +125
BLM18KG700TN1	70 ±25%	3500	0.022	-55 to +125
BLM18KG121TN1	120 ±25%	3000	0.030	-55 to +125
BLM18KG221SN1	220 ±25%	2200	0.050	-55 to +125
BLM18KG331SN1	330 ±25%	1700	0.080	-55 to +125
BLM18KG471SN1	470 ±25%	1500	0.130	-55 to +125
BLM18KG601SN1	600 ±25%	1300	0.150	-55 to +125

For the items of rated current higher than 1200mA, derating is required.
Please refer to p.66, "Derating of Rated Current".

1

■ Impedance - Frequency (Typical)

BLM18K Series



■ Impedance - Frequency Characteristics

BLM18KG260TN1



BLM18KG700TN1

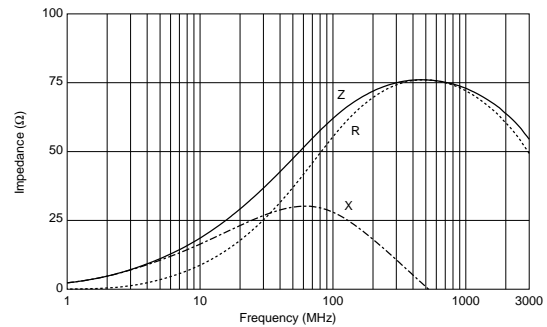

BLM18KG121TN1



BLM18KG221SN1

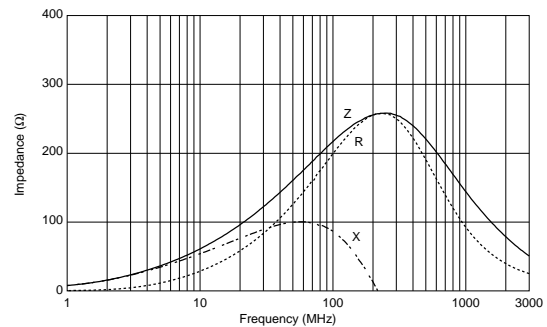

Continued on the following page. ↗

Continued from the preceding page.

Impedance - Frequency Characteristics

BLM18KG331SN1



BLM18KG471SN1

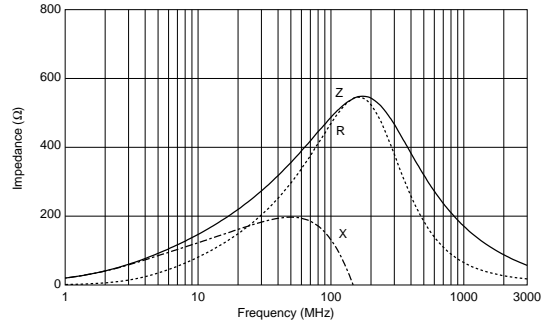

BLM18KG601SN1

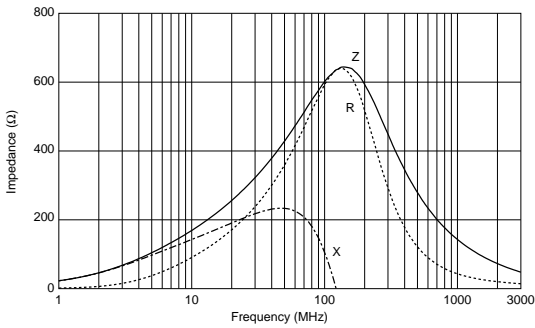

Notice (Rating)

In operating temperatures exceeding +85°C, derating of current is necessary for chip Ferrite Beads for which rated current is 1300mA or over. Please apply the derating curve shown in chart according to the operating temperature.

Derating

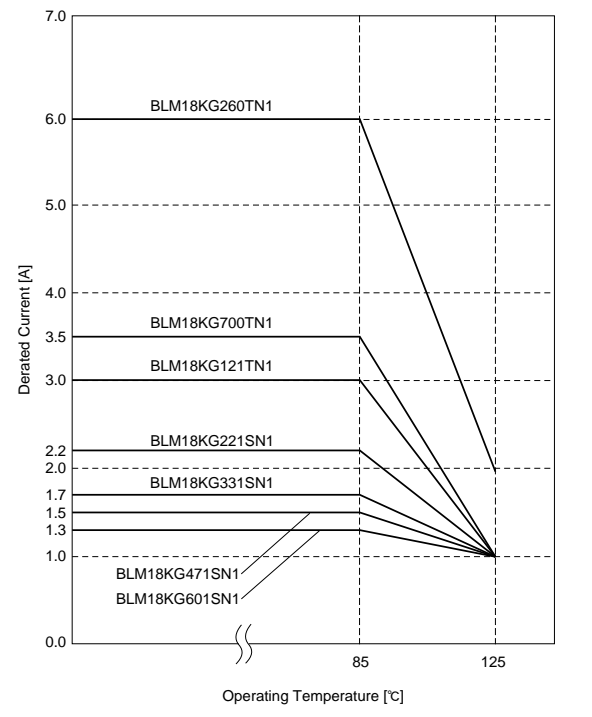

1

BLM18S Series (0603 Size)

■ Features

1. Low DC Resistance/Large Rated Current
2. BLM18S series can be used in high current circuits due to its low DC resistance.
It can match power lines to a maximum of 6A DC.
3. Ni+Sn plating structure of the external electrodes provides excellent solder heat resistance.

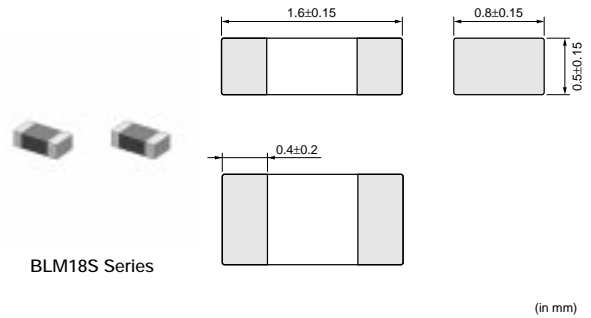

1

■ Applications

EMI suppression for DC power line

Part Number	Impedance (at 100MHz/20°C) (ohm)	Rated Current (mA)	DC Resistance (max.) (ohm)	Operating Temperature Range (°C)
BLM18SG260TN1	26 ±25%	6000	0.007	-55 to +125
BLM18SG700TN1	70 ±25%	4000	0.020	-55 to +125
BLM18SG121TN1	120 ±25%	3000	0.025	-55 to +125
BLM18SG221TN1	220 ±25%	2500	0.040	-55 to +125
BLM18SG331TN1	330 ±25%	1500	0.070	-55 to +125

For the items of rated current higher than 1500mA, derating is required. Please refer to p.68, "Derating of Rated Current".

■ Impedance - Frequency (Typical)

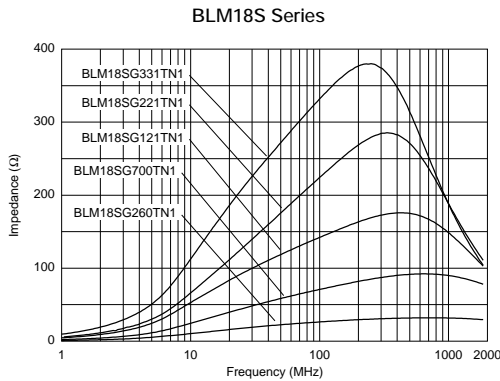

■ Impedance - Frequency Characteristics

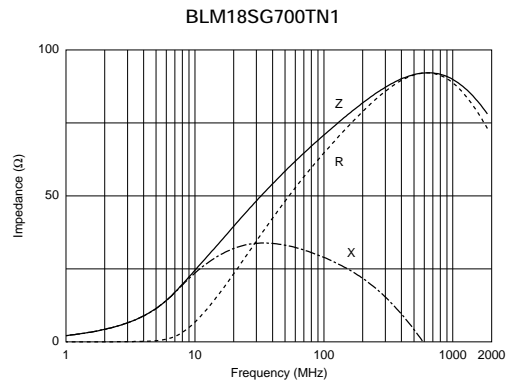
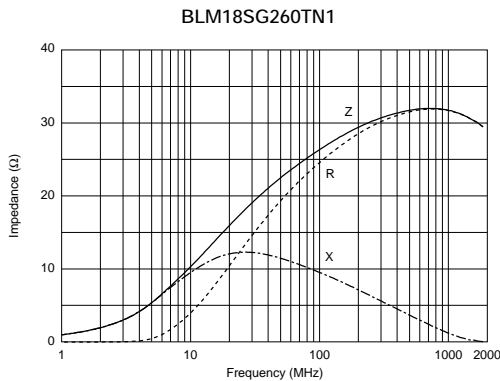

Continued on the following page. ↗

Continued from the preceding page.

Impedance - Frequency Characteristics

BLM18SG121TN1

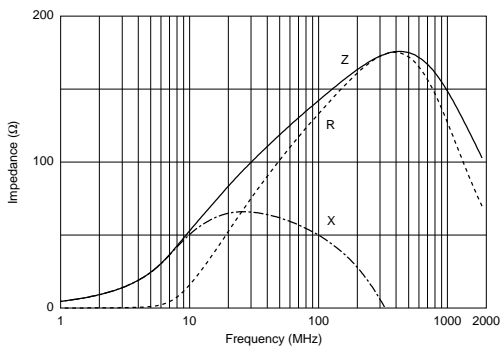

BLM18SG221TN1

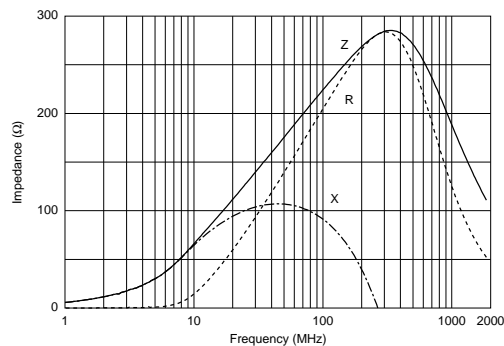

BLM18SG331TN1

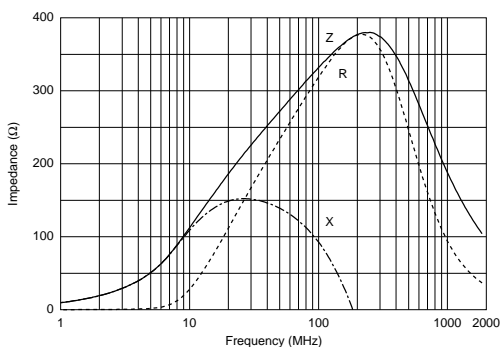

Notice (Rating)

In operating temperatures exceeding +85°C, derating of current is necessary for chip Ferrite Beads for which rated current is 1200mA or over. Please apply the derating curve shown in chart according to the operating temperature.

Derating

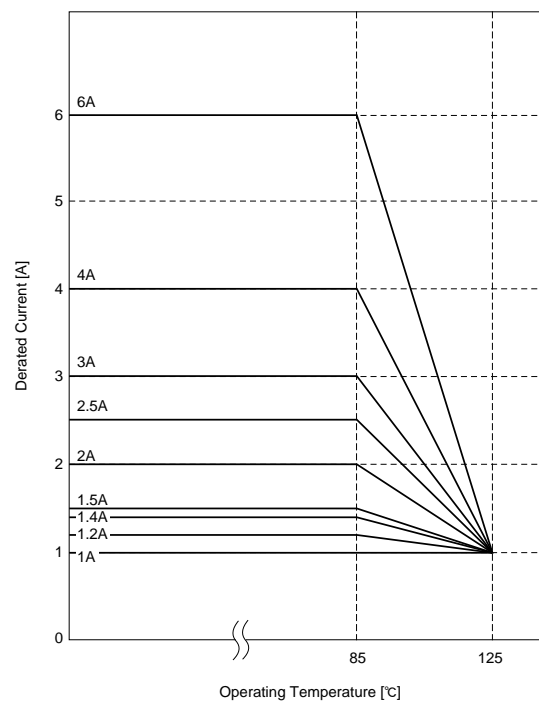

On-Board Type (DC) EMI Suppression Filters (EMIFIL®)



GHz Noise Suppression Chip Ferrite Beads BLM15H/15E/18H/18E Series

Excellent high frequency impedance characteristics with 0402 (EIA) size.

Equivalent Circuit

1

Features (BLM15HG/HD/EG Series)

1. Small size: 1.0x0.5mm (0402)
2. Suitable for noise suppression in 1GHz or higher frequency
3. Low DC Resistance/Large Rated Current (BLM15E)
4. No Lead production using Ni+Sn plating in termination

Applications

1. EMI suppression for Note PC and DSC
2. Noise suppression for data line in mobile phone
3. Prevention of erroneous operation caused by local oscillation signal in mobile phone
4. Optical pickup modules

Features (BLM15HB Series)

1. Small size: 1.0x0.5mm
2. Suitable for noise suppression in 1GHz or higher frequency
3. No Lead production using Ni+Sn plating in termination

Applications

1. EMI suppression for Note PC and DSC
2. Noise suppression for data line in mobile phone
3. Noise suppression for USB interface line in mobile phone
4. Prevention of erroneous operation caused by local oscillation signal in mobile phone

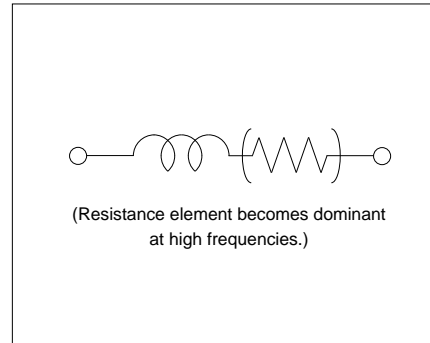

BLM15H Series (0402 Size)

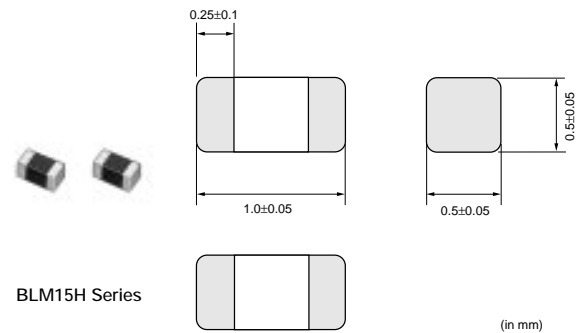

Part Number	Impedance (at 100MHz/20°C) (ohm)	Impedance (at 1GHz/20°C) (ohm)	Rated Current (mA)	DC Resistance (max.) (ohm)	Operating Temperature Range (°C)
BLM15HG601SN1	600 ±25%	1000 ±40%	300	0.7	-55 to +125
BLM15HG102SN1	1000 ±25%	1400 ±40%	250	1.1	-55 to +125
BLM15HB121SN1	120 ±25%	500 ±40%	300	0.7	-55 to +125

Continued on the following page.



Continued from the preceding page.

Part Number	Impedance (at 100MHz/20°C) (ohm)	Impedance (at 1GHz/20°C) (ohm)	Rated Current (mA)	DC Resistance (max.) (ohm)	Operating Temperature Range (°C)
BLM15HB221SN1	220 ±25%	900 ±40%	250	1.0	-55 to +125
BLM15HD601SN1	600 ±25%	1400 ±40%	300	0.85	-55 to +125
BLM15HD102SN1	1000 ±25%	2000 ±40%	250	1.25	-55 to +125
BLM15HD182SN1	1800 ±25%	2700 ±40%	200	2.2	-55 to +125

1

■ Impedance - Frequency (Typical)



■ Impedance - Frequency Characteristics



Continued on the following page. ↗

Continued from the preceding page.

■ Impedance - Frequency Characteristics

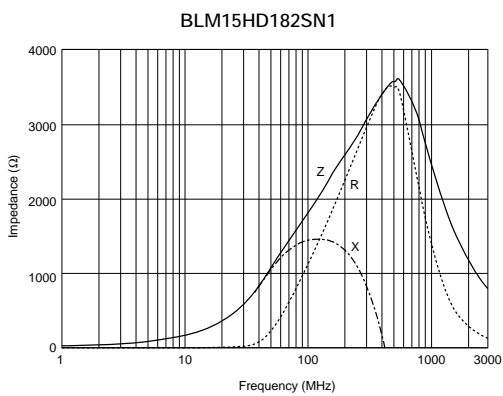
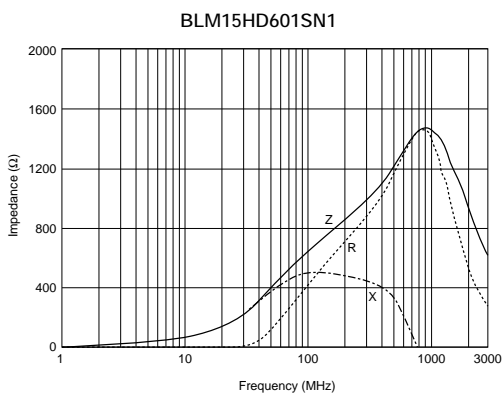
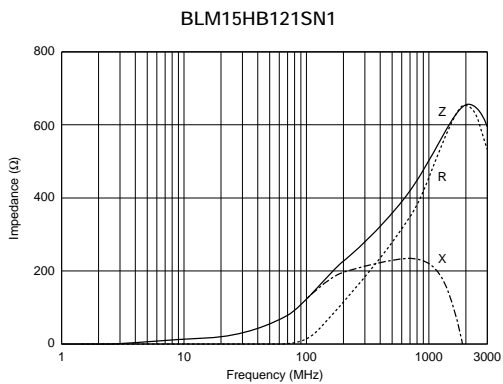

1

BLM15E Series (0402 Size)

1

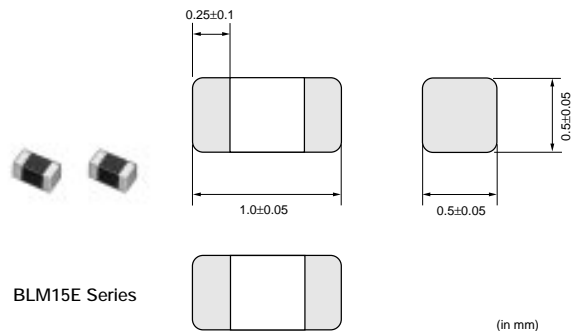

Part Number	Impedance (at 100MHz/20°C) (ohm)	Impedance (at 1GHz/20°C) (ohm)	Rated Current (mA)	DC Resistance (max.) (ohm)	Operating Temperature Range (°C)
BLM15EG121SN1	120 ±25%	145 (Typ.)	1500	0.095	-55 to +125
BLM15EG221SN1	220 ±25%	270 (Typ.)	700	0.28	-55 to +125

In operating temperature exceeding +85°C, derating of current is necessary for BLM15E series.
Please refer to p.73, "Derating of Rated Current".

■ Impedance - Frequency (Typical)



■ Impedance - Frequency Characteristics

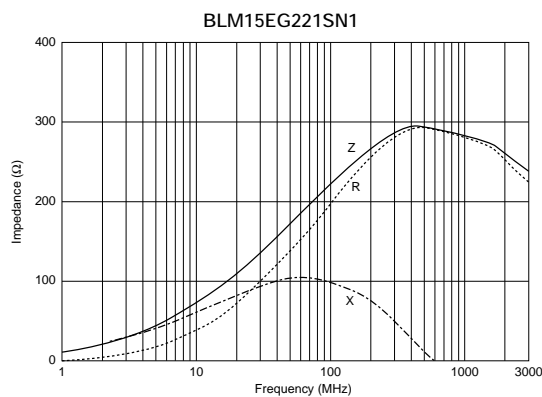

Continued on the following page. ↗

Continued from the preceding page.

■ Notice (Rating)

In operating temperature exceeding +85°C, derating of current is necessary for BLM15E series.

Please apply the derating curve shown in chart according to the operating temperature.

Derating

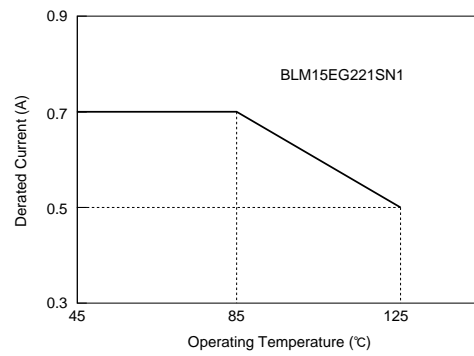
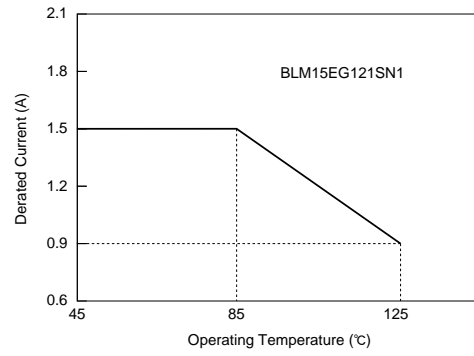

1

BLM18H/BLM18E series has a modified internal electrode structure, that minimizes stray capacitance and increases the effective frequency range.

■ Equivalent Circuit



■ Features (BLM18H series)

1. BLM18H series realizes high impedance at 1GHz and is suitable for noise suppression from 500MHz to GHz range. The impedance value of HG/HD-type is about three times as large as that of A/B-type at 1GHz, though the impedance characteristic of HG/HD-type is similar to A/B-type at 100MHz or less.
2. HG-type is effective in noise suppression in wide frequency range (several MHz to several GHz). HB/HD-type for high-speed signal line provides a sharper roll-off after the cut-off frequency. HK-type for digital interface and HE-type for optical pickup modules are effective in suppressing the ringing because resistance especially grows in the lower frequency.
3. The magnetic shielded structure minimizes crosstalk.

■ Features (BLM18E series)

1. Low DC Resistance and a large Rated Current are suitable for noise suppression of the driver circuit.
2. Excellent direct current characteristics
3. Thin type (t=0.5mm) is suitable for small and low profile equipment such as DSC, cellular phones.

BLM18H Series (0603 Size)

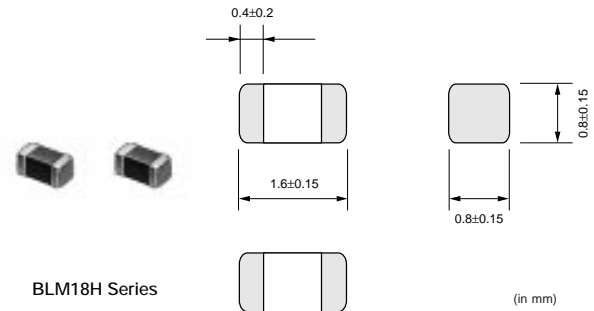

Part Number	Impedance (at 100MHz/20°C) (ohm)	Impedance (at 1GHz/20°C) (ohm)	Rated Current (mA)	DC Resistance (max.) (ohm)	Operating Temperature Range (°C)
BLM18HG471SN1	470 ±25%	600 (Typ.)	200	0.85	-55 to +125
BLM18HG601SN1	600 ±25%	700 (Typ.)	200	1.00	-55 to +125
BLM18HG102SN1	1000 ±25%	1000 (Typ.)	100	1.60	-55 to +125
BLM18HB121SN1	120 ±25%	500 ±40%	200	0.50	-55 to +125
BLM18HB221SN1	220 ±25%	1100 ±40%	100	0.80	-55 to +125
BLM18HB331SN1	330 ±25%	1600 ±40%	50	1.20	-55 to +125
BLM18HD471SN1	470 ±25%	1000 (Typ.)	100	1.20	-55 to +125
BLM18HD601SN1	600 ±25%	1200 (Typ.)	100	1.50	-55 to +125
BLM18HD102SN1	1000 ±25%	1700 (Typ.)	50	1.80	-55 to +125
BLM18HE601SN1	600 ±25%	600 (Typ.)	800	0.25	-55 to +125
BLM18HE102SN1	1000 ±25%	1000 (Typ.)	600	0.35	-55 to +125
BLM18HE152SN1	1500 ±25%	1500 (Typ.)	500	0.50	-55 to +125
BLM18HK331SN1	330 ±25%	400 ±40%	200	0.50	-55 to +125
BLM18HK471SN1	470 ±25%	600 ±40%	200	0.70	-55 to +125

Continued on the following page.

Continued from the preceding page.

Part Number	Impedance (at 100MHz/20°C) (ohm)	Impedance (at 1GHz/20°C) (ohm)	Rated Current (mA)	DC Resistance (max.) (ohm)	Operating Temperature Range (°C)
BLM18HK601SN1	600 ±25%	700 ±40%	100	0.90	-55 to +125
BLM18HK102SN1	1000 ±25%	1200 ±40%	50	1.50	-55 to +125

In operating temperature exceeding +85°C, derating of current is necessary for BLM18HE series.
 Please refer to p.78, "Derating of Rated Current".

■ Impedance - Frequency (Typical)

1

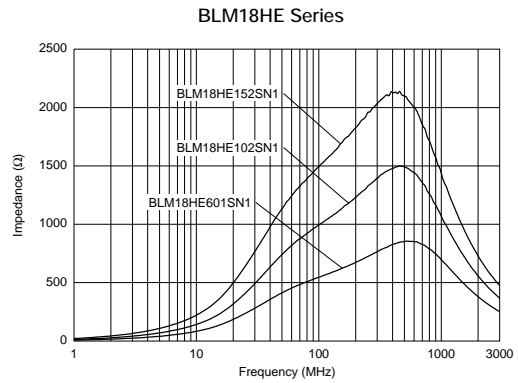
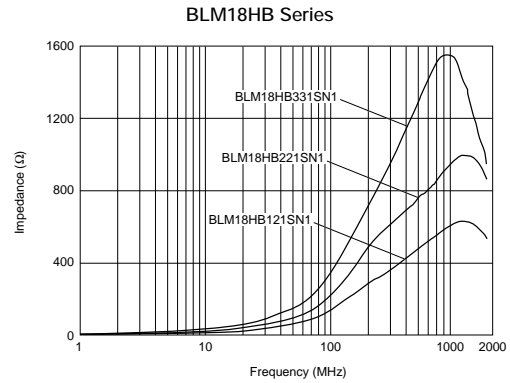

■ Impedance - Frequency Characteristics

BLM18HG471SN1

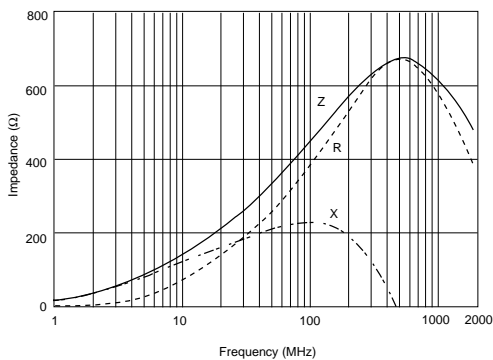

BLM18HG601SN1



BLM18HG102SN1

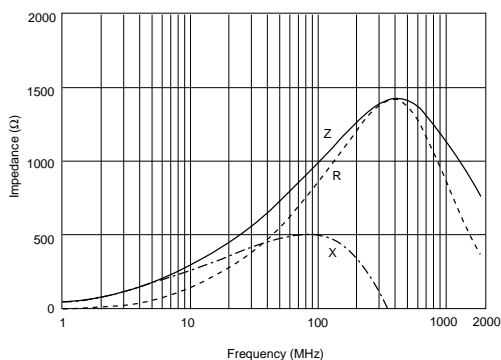

BLM18HB121SN1

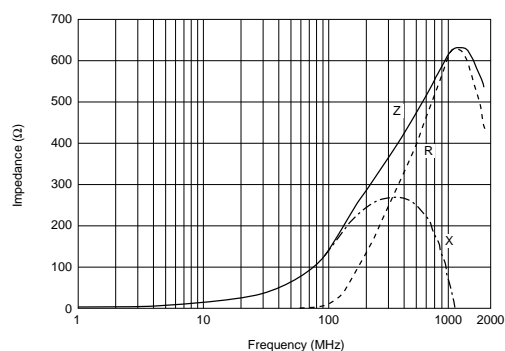

BLM18HB221SN1



BLM18HB331SN1

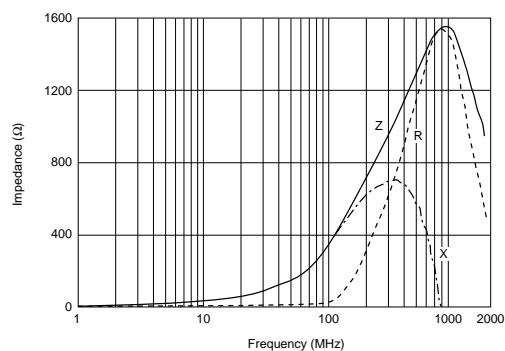

BLM18HD471SN1

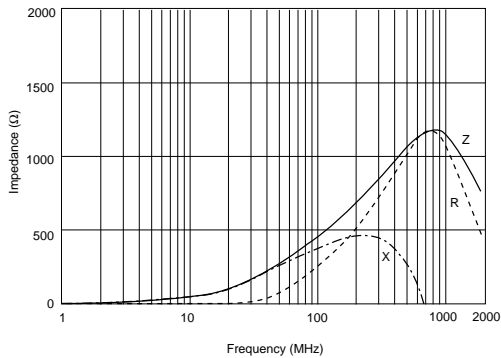

BLM18HD601SN1

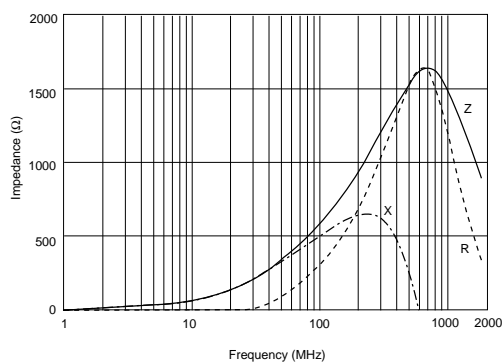

1

Continued from the preceding page.

Impedance - Frequency Characteristics

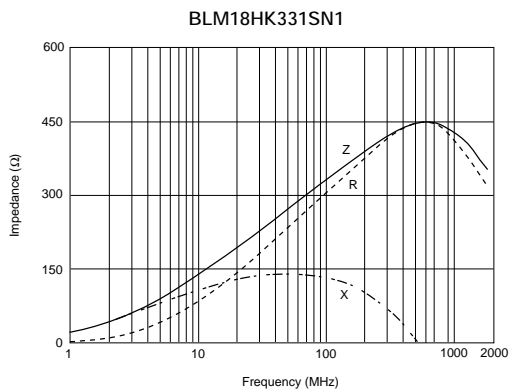
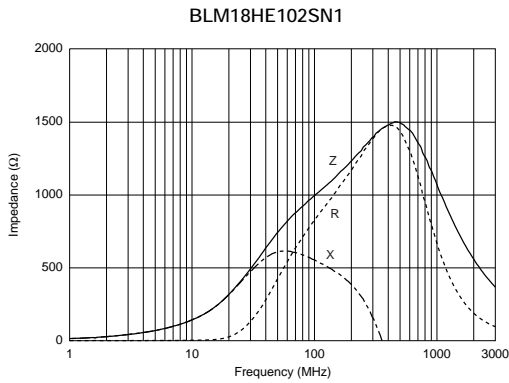

1

Continued on the following page.

Continued from the preceding page.

Notice (Rating)

In operating temperature exceeding +85°C, derating of current is necessary for BLM18HE series.
 Please apply the derating curve shown in chart according to the operating temperature.

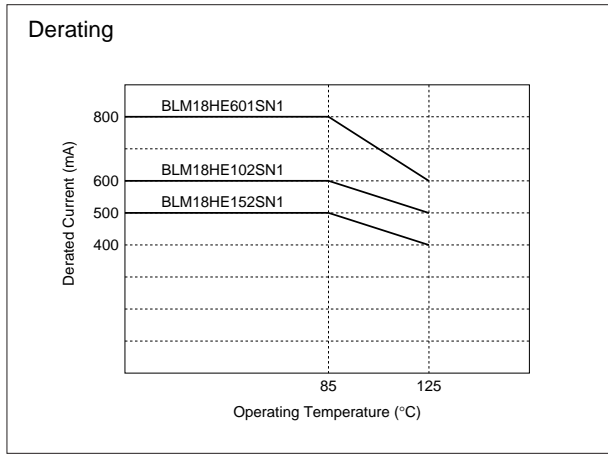

1

BLM18E Series (0603 Size)

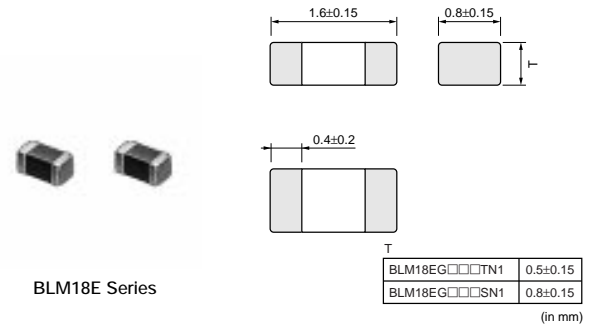

Part Number	Impedance (at 100MHz/20°C) (ohm)	Impedance (at 1GHz/20°C) (ohm)	Rated Current (mA)	DC Resistance (max.) (ohm)	Operating Temperature Range (°C)
BLM18EG101TN1	100 ±25%	140 (Typ.)	2000	0.045	-55 to +125
BLM18EG121SN1	120 ±25%	145 (Typ.)	2000	0.04	-55 to +125
BLM18EG221SN1	220 ±25%	260 (Typ.)	2000	0.05	-55 to +125
BLM18EG221TN1	220 ±25%	300 (Typ.)	1000	0.15	-55 to +125
BLM18EG331TN1	330 ±25%	450 (Typ.)	500	0.21	-55 to +125
BLM18EG391TN1	390 ±25%	520 (Typ.)	500	0.3	-55 to +125
BLM18EG471SN1	470 ±25%	550 (Typ.)	500	0.21	-55 to +125
BLM18EG601SN1	600 ±25%	700 (Typ.)	500	0.35	-55 to +125

For the items of rated current higher than 2000mA, derating is required.
 Please refer to p.80, "Derating of Rated Current".

Impedance - Frequency (Typical)

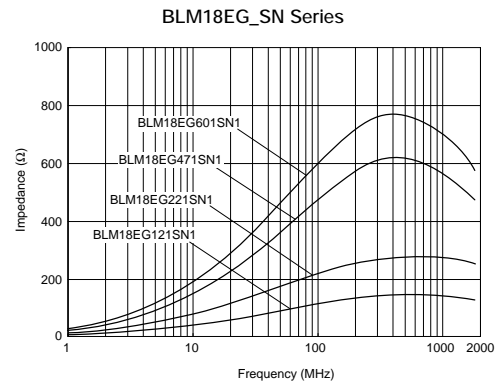
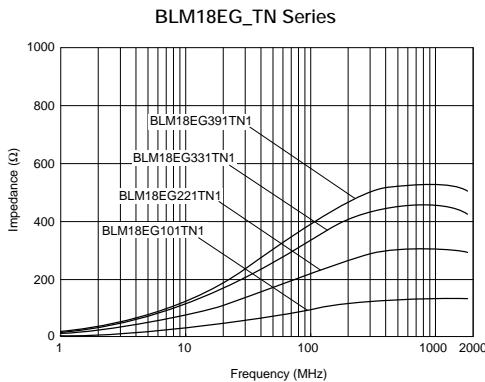

■ Impedance - Frequency Characteristics

BLM18EG101TN1



BLM18EG121SN1



1

BLM18EG221SN1



BLM18EG221TN1



BLM18EG331TN1



BLM18EG391TN1

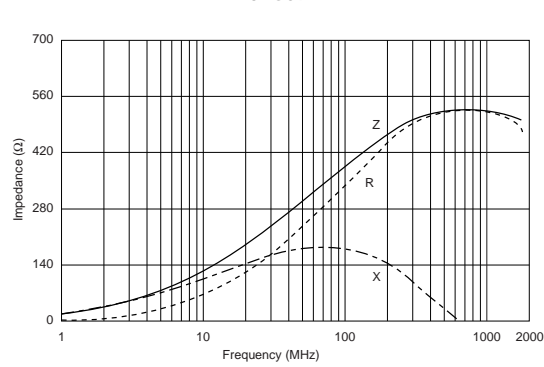

BLM18EG471SN1



BLM18EG601SN1

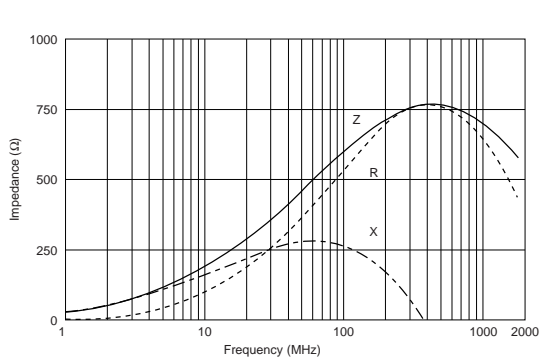

Continued on the following page.

☒ Continued from the preceding page.

■ Notice (Rating)

In operating temperatures exceeding +85°C, derating of current is necessary for chip Ferrite Beads for which rated current is 1200mA or over. Please apply the derating curve shown in chart according to the operating temperature.

1



On-Board Type (DC) EMI Suppression Filters (EMIFIL®)



High-GHz Noise Suppression Chip Ferrite Beads BLM15G/18G Series

Chip ferrite beads for high frequency noise suppression over a wide frequency range.

■ Equivalent Circuit

1

■ Features

1. High impedance characteristic in 1GHz or higher frequency
2. High impedance characteristic over a wide frequency band range of 100MHz to 6GHz
3. Small decrease in impedance during current loading, resulting in small impedance fluctuation during equipment operation.
4. Reflow soldering only

■ Applications

1. Noise suppression for PCs with high-speed CPU and high-speed bus, and for interface lines of peripheral equipment.
2. High harmonic noise suppression for digital equipment with several hundred MHz or higher clock speeds.
3. Prevention of erroneous operation caused by local oscillation signals in mobile phone and W-LAN module (ensuring self-immunity).
4. Bias Tee modules in optical transceivers



BLM15G Series (0402 Size)

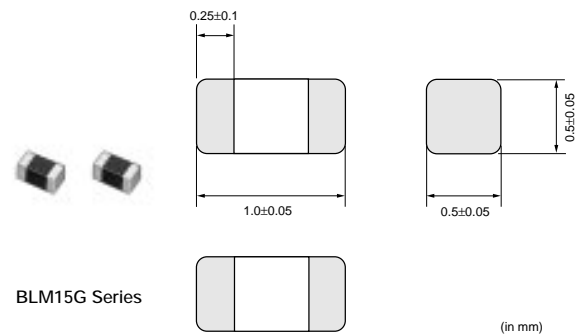

Part Number	Impedance (at 100MHz/20°C) (ohm)	Impedance (at 1GHz/20°C) (ohm)	Rated Current (mA)	DC Resistance (max.) (ohm)	Operating Temperature Range (°C)
BLM15GG221SN1	220 ±25%	600 ±40%	300	0.7	-55 to +125
BLM15GG471SN1	470 ±25%	1200 ±40%	200	1.3	-55 to +125
BLM15GA750SN1	75 ±25%	1000 ±40%	200	1.3	-55 to +125

■ Impedance - Frequency (Typical)

BLM15G Series

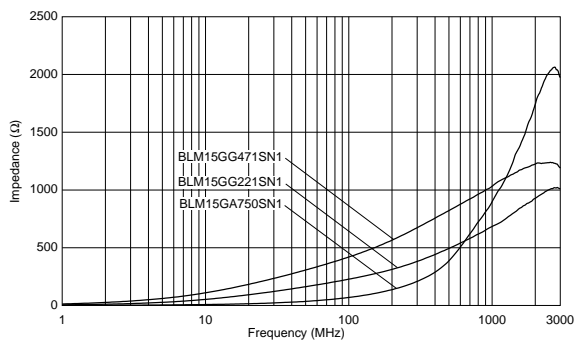

1

■ Impedance - Frequency Characteristics

BLM15GG221SN1



BLM15GG471SN1

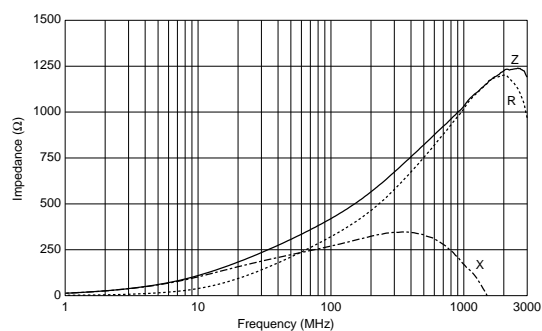

BLM15GA750SN1



BLM18G Series (0603 Size)



1

Part Number	Impedance (at 100MHz/20°C) (ohm)	Impedance (at 1GHz/20°C) (ohm)	Rated Current (mA)	DC Resistance (max.) (ohm)	Operating Temperature Range (°C)
BLM18GG471SN1	470 ±25%	1800 ±30%	200	1.30	-55 to +125

■ Impedance - Frequency (Typical)



■ Impedance - Frequency Characteristics



Noise Suppression Effect

■ Noise Suppression in UHF Range

1

Testing Circuit

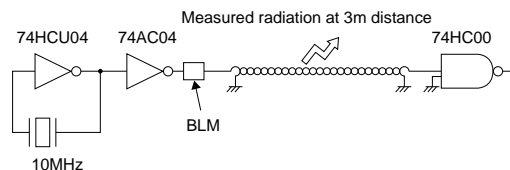

Type of Filter	EMI Suppression Effect	Description
Initial (No filter)		
Conventional Type BLM18AG102SN1 (1000Ω at 100MHz)		Current BLM are effective in suppressing noise in the range between 300MHz and 700MHz.
for GHz Noise Suppression BLM18HG102SN1 (1000Ω at 100MHz)		In addition to the effectiveness of current BLM, BLM18HG suppresses noise in the range beyond 700MHz.

Comparison between BLM18HG102SN1 and BLM18AG102SN1 (Current Item)

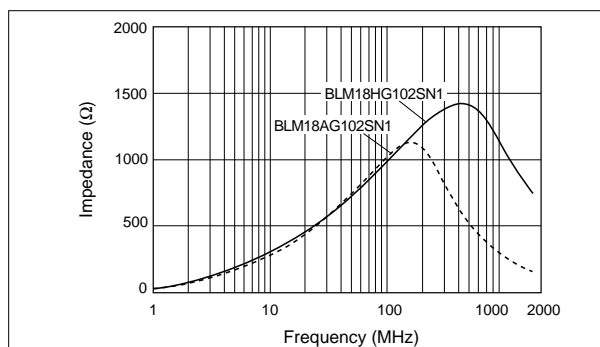

On-Board Type (DC) EMI Suppression Filters (EMIFIL®)



Chip Ferrite Beads Arrays BLA2AA/2AB/31A/31B Series

BLA2AA/BLA2AB Series

■ Features

1. BLA2AA/2AB series has 4 circuits in 2.0x1.0mm body with 0.5mm pitch.
2. Provides attenuation across a broad frequency range. Two types of impedance characteristics are available, one is for general signal line and the other is for high speed signal line.
3. Original inner electrode structure enables extra low crosstalk.
4. The nickel barrier structure of the external electrodes provides excellent solder heat resistance.



■ Applications

Notebook size PCs, PDAs and other compact size digital equipment

Part Number	Impedance (at 100MHz/20°C) (ohm)	Rated Current (mA)	DC Resistance (max.) (ohm)	Operating Temperature Range (°C)
BLA2AAG121SN4	120 ±25%	100	0.50	-55 to +125
BLA2AAG221SN4	220 ±25%	50	0.70	-55 to +125
BLA2AAG601SN4	600 ±25%	50	1.10	-55 to +125
BLA2AAG102SN4	1000 ±25%	50	1.30	-55 to +125
BLA2ABB100SN4	10 ±25%	200	0.1	-55 to +125
BLA2ABB220SN4	22 ±25%	200	0.2	-55 to +125
BLA2ABB470SN4	47 ±25%	200	0.35	-55 to +125
BLA2ABB121SN4	120 ±25%	50	0.60	-55 to +125
BLA2ABB221SN4	220 ±25%	50	0.90	-55 to +125
BLA2ABD750SN4	75 ±25%	200	0.20	-55 to +125
BLA2ABD121SN4	120 ±25%	200	0.35	-55 to +125
BLA2ABD221SN4	220 ±25%	100	0.40	-55 to +125
BLA2ABD471SN4	470 ±25%	100	0.65	-55 to +125
BLA2ABD601SN4	600 ±25%	100	0.80	-55 to +125
BLA2ABD102SN4	1000 ±25%	50	1.00	-55 to +125

Number of Circuits: 4

1

Equivalent Circuit



Impedance - Frequency (Typical)

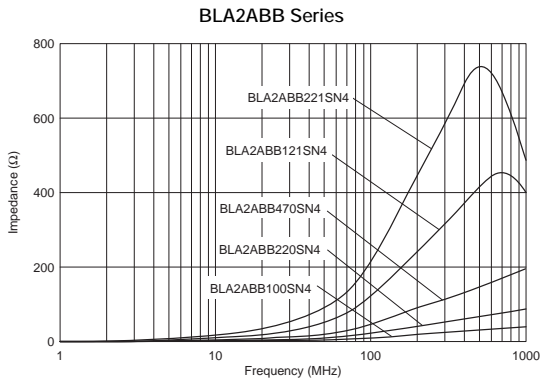

Impedance - Frequency Characteristics



Continued on the following page. ↗

Continued from the preceding page.

Impedance - Frequency Characteristics

BLA2ABB100SN4

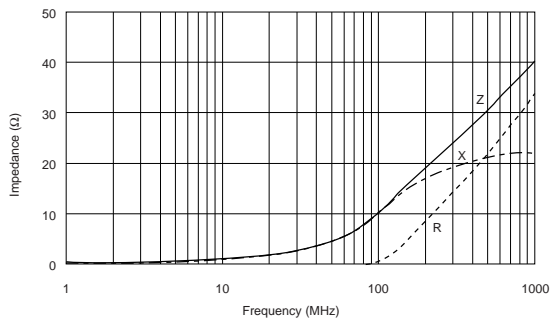

BLA2ABB220SN4

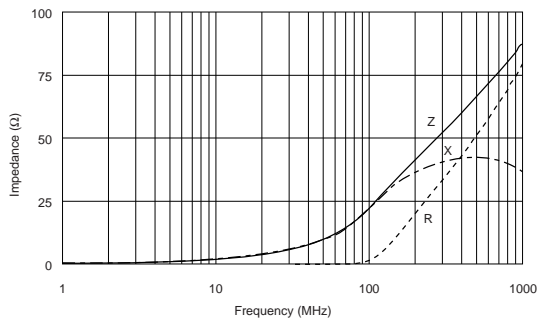

BLA2ABB470SN4

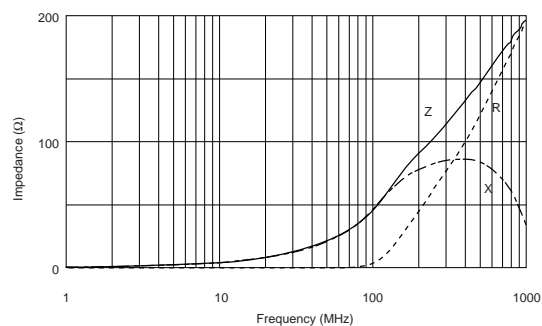

BLA2ABB121SN4



BLA2ABB221SN4

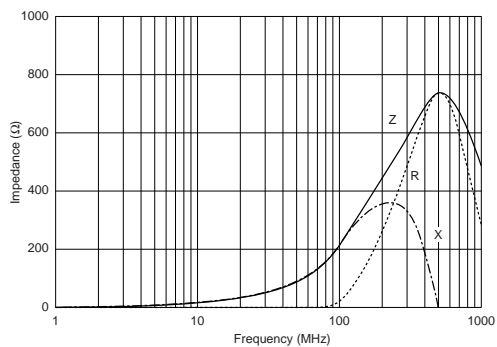

BLA2ABD750SN4

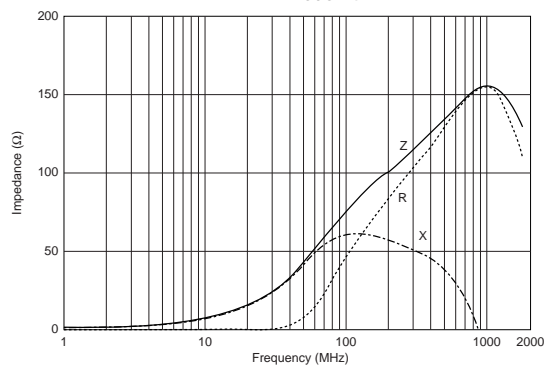

BLA2ABD121SN4

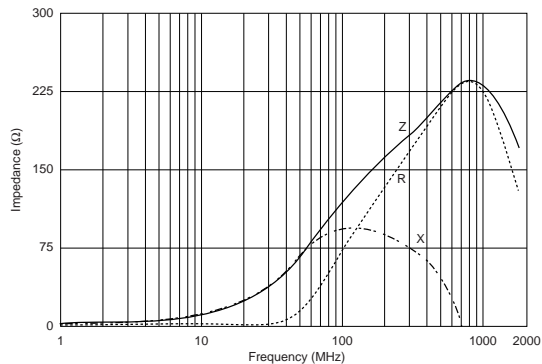

BLA2ABD221SN4

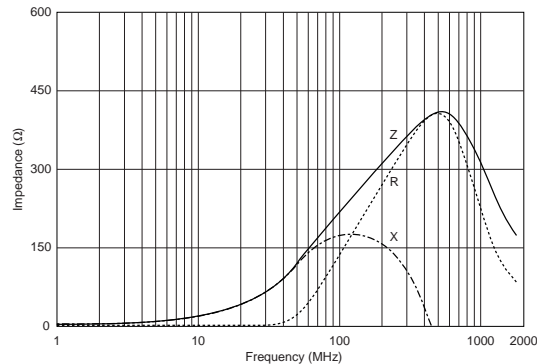

Continued on the following page. ↗

1

Continued from the preceding page.

Impedance - Frequency Characteristics

BLA2ABD471SN4

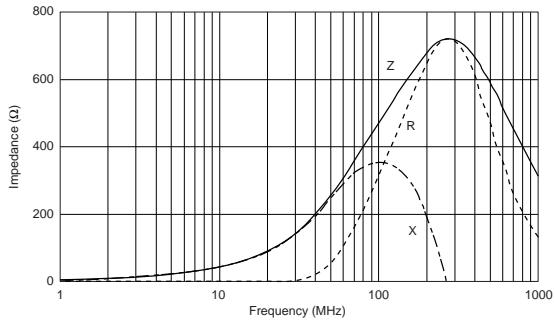

BLA2ABD601SN4

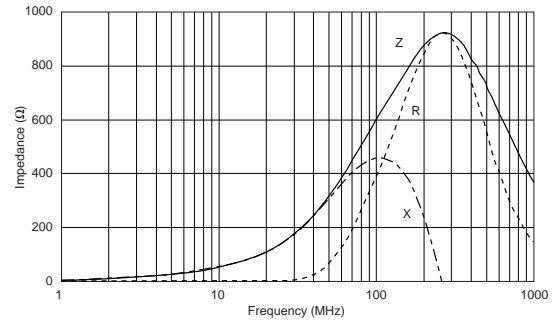

BLA2ABD102SN4

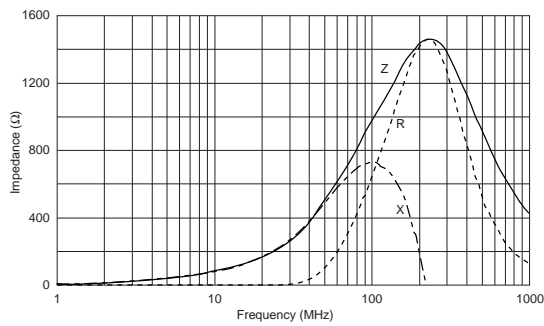

1

BLA31A/BLA31B Series

The miniaturization of electronic equipment requires high performance EMI filters which enable high density mounting. BLA31A/B series consists of 4 circuits of ferrite beads.

BLA31A/B is suitable for EMI suppression in smaller digital equipment.

■ Features

1. BLA31A/B has 4 circuits in 3.2x1.6mm body with 0.8mm pitch.
2. Provides attenuation across a broad frequency range.
Two types of impedance are available which meet general signal line and high speed signal line.
3. Original inner electrode structure enables extra low crosstalk.
4. The nickel barrier structure of the external electrodes provides excellent solder heat resistance. Both flow and reflow soldering methods can be employed.

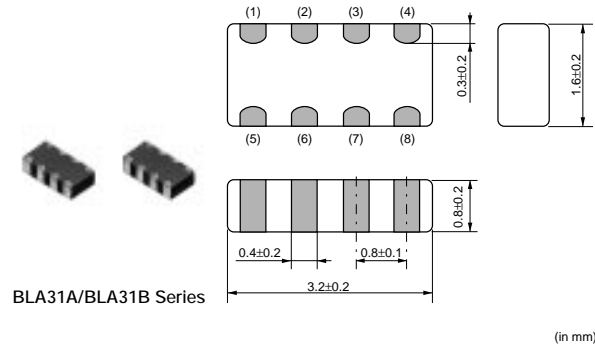

1

Part Number	Impedance (at 100MHz/20°C) (ohm)	Rated Current (mA)	DC Resistance (max.) (ohm)	Operating Temperature Range (°C)
BLA31AG300SN4	30 ±25%	200	0.10	-55 to +125
BLA31AG600SN4	60 ±25%	200	0.15	-55 to +125
BLA31AG121SN4	120 ±25%	150	0.20	-55 to +125
BLA31AG221SN4	220 ±25%	150	0.25	-55 to +125
BLA31AG601SN4	600 ±25%	100	0.35	-55 to +125
BLA31AG102SN4	1000 ±25%	50	0.45	-55 to +125
BLA31BD121SN4	120 ±25%	150	0.30	-55 to +125
BLA31BD221SN4	220 ±25%	150	0.35	-55 to +125
BLA31BD471SN4	470 ±25%	100	0.40	-55 to +125
BLA31BD601SN4	600 ±25%	100	0.45	-55 to +125
BLA31BD102SN4	1000 ±25%	50	0.55	-55 to +125

Number of Circuits: 4

■ Equivalent Circuit



■ Impedance - Frequency (Typical)

BLA31A Series

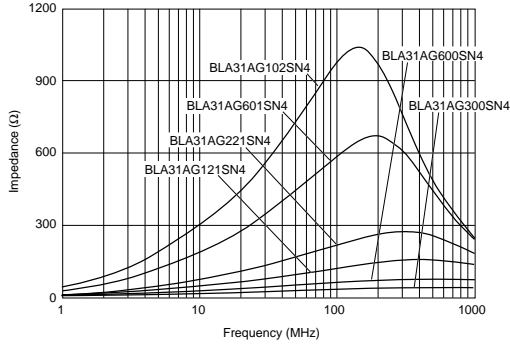

BLA31B Series

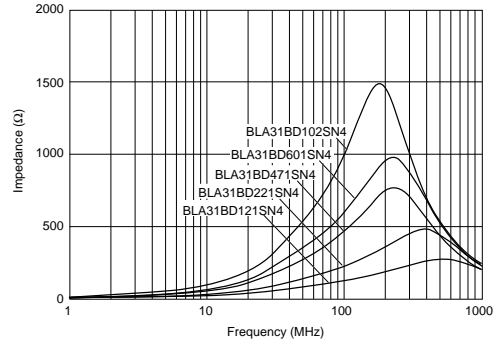

■ Impedance - Frequency Characteristics

BLA31AG300SN4

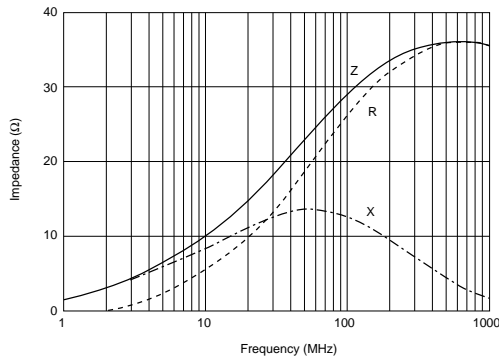

BLA31AG600SN4

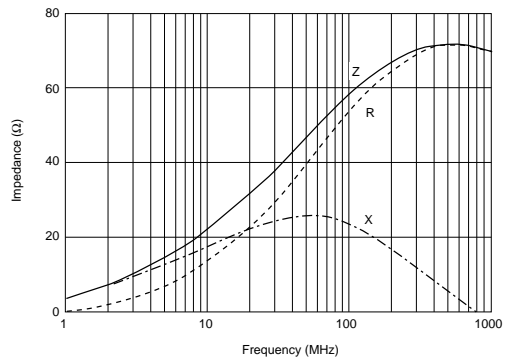

BLA31AG121SN4

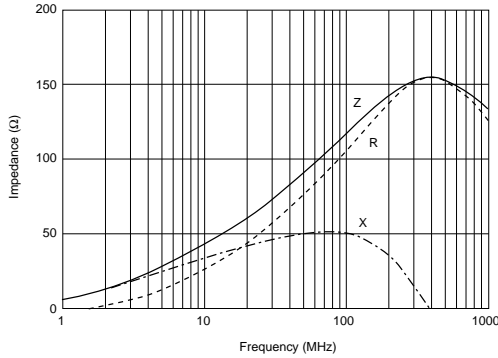

BLA31AG221SN4

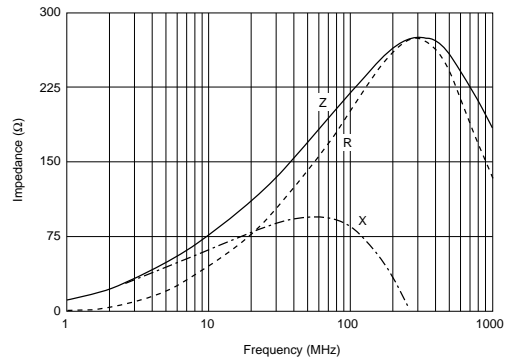

BLA31AG601SN4

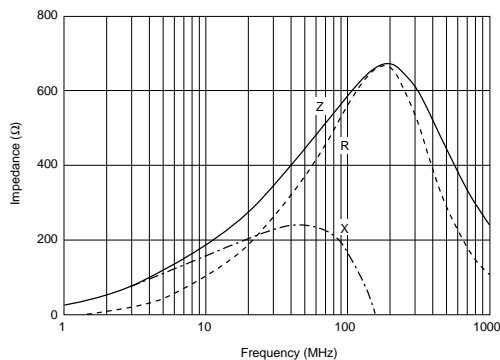

BLA31AG102SN4

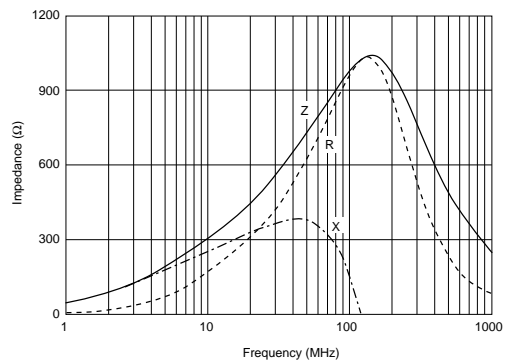

1

Continued from the preceding page.

Impedance - Frequency Characteristics

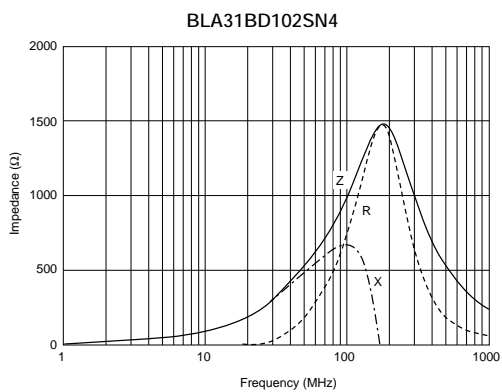
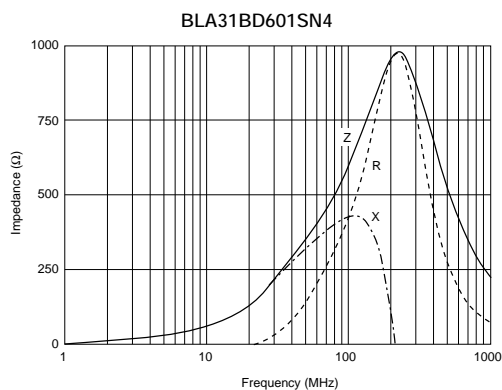
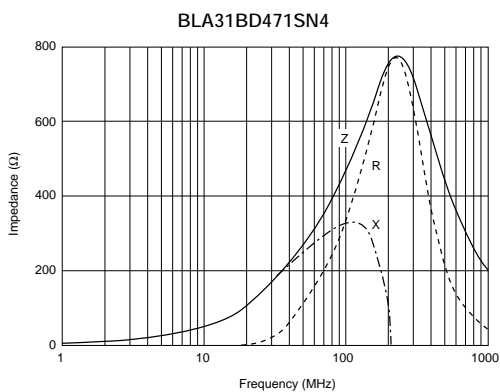
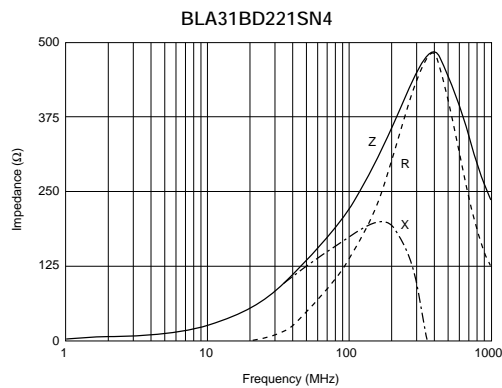
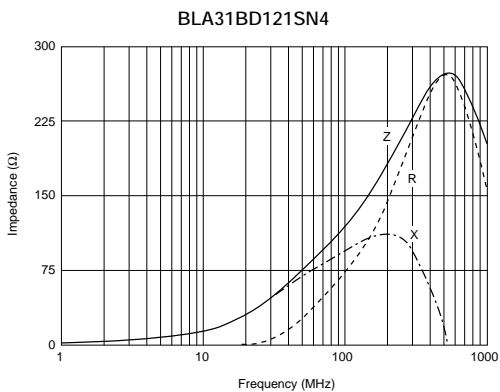

1

On-Board Type (DC) EMI Suppression Filters (EMIFIL®)



Chip EMIFIL® Part Numbering

Chip EMIFIL® Capacitor Type/Capacitor Array Type

(Part Number)

NF	M	3D	CC	102	R	1H	3	L
①	②	③	④	⑤	⑥	⑦	⑧	⑨

① Product ID

Product ID	
NF	Chip EMIFIL®

② Structure

Code	Structure
M	Capacitor Type
A	Capacitor Array Type

③ Dimensions (L×W)

Code	Dimensions (L×W)	EIA
18	1.6×0.8mm	0603
21	2.0×1.25mm	0805
3D	3.2×1.25mm	1205
31	3.2×1.6mm	1206
41	4.5×1.6mm	1806
55	5.7×5.0mm	2220

④ Features

Code	Features
CC	Capacitor Type for Signal Lines
PC	Capacitor Type for Large Current
PS	High Loss Type for Large Current

⑤ Capacitance

Expressed by three figures. The unit is in pico-farad (pF). The first and second figures are significant digits, and the third figure expresses the number of zeros which follow the two figures.

⑨ Packaging

Code	Packaging	Series
L	Embossed Taping (ø180mm Reel)	NFM3D/NFM41/NFM55
B	Bulk	All series
D	Paper Taping (ø180mm Reel)	NFM18/NFM21/NFA□□CC

⑥ Characteristics

Code	Capacitance Change (Temperature Characteristics)
B	±10%
F	+30/-80%
R	±15%
U	-750 ±120ppm/°C
S	+350 to -1000ppm/°C

⑦ Rated Voltage

Code	Rated Voltage
0J	6.3V
1A	10V
1C	16V
1E	25V
1H	50V
2A	100V

⑧ Electrode/Others (NFM Series)

Code	Electrode	Series
3	Sn Plating	NFM (Except NFM55)
4	Solder Coating	NFM55

⑥ Number of Circuits (NFA□□CC Series)

Code	Number of Circuits
4	4 Circuits

Chip EMIFIL® LC Combined Type

(Part Number)

NF	L	18	ST	107	X	1C	3	L
①	②	③	④	⑤	⑥	⑦	⑧	⑨

① Product ID

Product ID	
NF	Chip EMIFIL®

② Structure

Code	Structure
L	Monolithic, LC Combined Type
W	Winding, LC Combined Type
E	Block, LC Combined Type

③ Dimensions (L×W)

Code	Dimensions (L×W)	EIA
18	1.6×0.8mm	0603
21	2.0×1.25mm	0805
31	3.2×1.6mm	1206
61	6.8×1.6mm	2606

④ Features

Code	Features
SP	π Circuit for Signal Lines
ST	T Circuit for Signal Lines
PT	T Circuit for Large Current

⑤ Cut-off Frequency (NFL/NFW Series)

Expressed by three figures. The unit is in hertz (Hz). The first and second figures are significant digits, and the third figure expresses the number of zeros which follow the two figures.

⑥ Capacitance (NFE Series)

Expressed by three figures. The unit is in pico-farad (pF). The first and second figures are significant digits, and the third figure expresses the number of zeros which follow the two figures.

⑨ Packaging

Code	Packaging	Series
K	Embossed Taping (ø330mm Reel)	NFW31/NFE
L	Embossed Taping (ø180mm Reel)	NFW31/NFE
B	Bulk	NFL18/NFL21/NFE
D	Paper Taping (ø180mm Reel)	NFL18/NFL21

⑥ Characteristics (NFL/NFW Series)

Code	Characteristics
X	Cut-off Frequency

⑥ Characteristics (NFE Series)

Code	Capacitance Change (Temperature Characteristics)
B	±10%
C	±20%, ±22%
D	+20/-30%, +22/-33%
E	+20/-55%, +22/-56%
F	+30/-80%, +22/-82%
R	±15%
U	-750 ±120ppm/ °C
Z	Other

⑦ Rated Voltage

Code	Rated Voltage
1A	10V
1C	16V
1E	25V
1H	50V
2A	100V

⑧ Electrode

Code	Electrode	Series
3/7	Sn Plating	NFL
4	Lead Free Solder Coating	NFW
9	Others	NFE

2

Chip EMIFIL® LC Combined Array Type (NFA18S/21S Series)

(Part Number)

NF	A	21	SL	207	X	1A	4	5	L
①	②	③	④	⑤	⑥	⑦	⑧	⑨	⑩

① Product ID

Product ID	
NF	Chip EMIFIL®

② Structure

Code	Structure
A	Array Type

③ Dimensions (L×W)

Code	Dimensions (L×W)	EIA
18	1.6×0.8mm	0603
21	2.0×1.25mm	0805

④ Features

Code	Features
SL	L Circuit for Signal Lines

⑤ Cut-off Frequency

Expressed by three figures. The unit is in hertz (Hz). The first and second figures are significant digits, and the third figure expresses the number of zeros which follow the two figures.

⑥ Features

Code	Features
X	Expressed by a letter
V	

⑦ Rated Voltage

Code	Rated Voltage
1A	10V

⑧ Number of Circuits

Code	Number of Circuits
4	4 Circuits

⑨ Dimensions (T)

Code	Dimensions (T)
5	Low Profile
8	Standard

⑩ Packaging

Code	Packaging
B	Bulk
L	Embossed Taping (ø180mm Reel)

Chip EMIFIL® RC Combined Type/RC Combined Array Type

(Part Number)

NF	R	21	GD	470	470	2	L
①	②	③	④	⑤	⑥	⑦	⑧

① Product ID

Product ID	
NF	Chip EMIFIL®

② Structure

Code	Structure
R	RC Combined Type
A	RC Combined Array Type

③ Dimensions (L×W)

Code	Dimensions (L×W)	EIA
21	2.0×1.25mm	0805
31	3.2×1.6mm	1206

④ Features

Code	Features
GD	RC Combined Type for Signal Lines

⑥ Packaging

Code	Packaging	Series
L	Embossed Taping (ø180mm Reel)	NFR
B	Bulk	All Series
D	Paper Taping (ø180mm Reel)	NFA□□GD

⑤ Capacitance

Expressed by three figures. The unit is in pico-farad (pF). The first and second figures are significant digits, and the third figure expresses the number of zeros which follow the two figures.

⑥ Resistance

Expressed by three-digit alphanumerics. The unit is in ohm (Ω). The first and second figures are significant digits, and the third figure expresses the number of zeros which follow the two figures. If there is a decimal point, it is expressed by the capital letter "R". In this case, all figures are significant digits.

⑦ Electrode/Others (NFR Series)

Code	Electrode
2	Sn Plating

⑦ Number of Circuits (NFA□□GD Series)

Code	Number of Circuits
4	4 Circuits

On-Board Type (DC) EMI Suppression Filters (EMIFIL®)



Chip EMIFIL® Capacitor Type NFM18C/21C/3DC/41C Series

NFM18C Series

NFM18C series is a 1.6x0.8mm EMI suppression filter for signal lines which have a three terminal structure using Murata's multilayer technology.

■ Features

1. Ultra small size in 1.6x0.8x0.6mm enables high density mounting.
2. Three terminal structure with low residual inductance (ESL)* characteristics achieves large insertion loss characteristics even in high frequency area.
3. NFM18C series covers capacitance range from 22 to 22,000pF.

* Not exceeding one-tenth of monolithic ceramic capacitors (two terminals).

■ Applications

1. EMI suppression of circuit for insertion loss in quantity
2. Noise suppression up to GHz

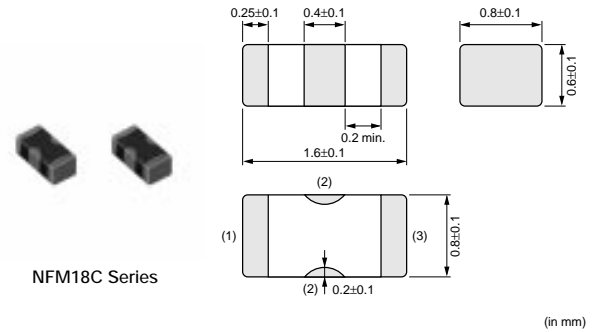

2

Part Number	Capacitance (pF)	Rated Voltage (Vdc)	Rated Current (mA)	Insulation Resistance (min.) (M ohm)	Operating Temperature Range (°C)
NFM18CC220U1C3	22 +20%, -20%	16	400	1000	-55 to +125
NFM18CC470U1C3	47 +20%, -20%	16	400	1000	-55 to +125
NFM18CC101R1C3	100 +20%, -20%	16	500	1000	-55 to +125
NFM18CC221R1C3	220 +20%, -20%	16	500	1000	-55 to +125
NFM18CC471R1C3	470 +20%, -20%	16	500	1000	-55 to +125
NFM18CC102R1C3	1000 +20%, -20%	16	600	1000	-55 to +125
NFM18CC222R1C3	2200 +20%, -20%	16	700	1000	-55 to +125
NFM18CC223R1C3	22000 +20%, -20%	16	1000	1000	-55 to +125

■ Equivalent Circuit



■ Insertion Loss Characteristics



NFM21C Series

The chip "EMIFIL" NFM21C series is a chip type three terminal EMI suppression filter. It can reduce residual inductance to an extremely low level making it excellent for noise suppression at high frequencies.

■ Features

1. Small and low profile of 2.0x1.25x0.85mm enables high density mounting.
2. Three terminal structure enables high performance in high frequency range.
3. Uses original electrode structure which realizes excellent solderability.
4. An electrostatic capacitance range of 22 to 22,000pF enables suppression of noise at specific frequencies.



2

■ Applications

1. PCs and peripherals which emit high amount of noise
2. Compact size equipment such as PDAs, PC cards and mobile telecommunications equipment
3. Severe EMI suppression and high impedance circuits such as digital circuits

Part Number	Capacitance (pF)	Rated Voltage (Vdc)	Rated Current (mA)	Insulation Resistance (min.) (M ohm)	Operating Temperature Range (°C)
NFM21CC220U1H3	22 +20%, -20%	50	700	1000	-55 to +125
NFM21CC470U1H3	47 +20%, -20%	50	700	1000	-55 to +125
NFM21CC101U1H3	100 +20%, -20%	50	700	1000	-55 to +125
NFM21CC221R1H3	220 +20%, -20%	50	700	1000	-55 to +125
NFM21CC471R1H3	470 +20%, -20%	50	1000	1000	-55 to +125
NFM21CC102R1H3	1000 +20%, -20%	50	1000	1000	-55 to +125
NFM21CC222R1H3	2200 +20%, -20%	50	1000	1000	-55 to +125
NFM21CC223R1H3	22000 +20%, -20%	50	2000	1000	-55 to +125

■ Equivalent Circuit

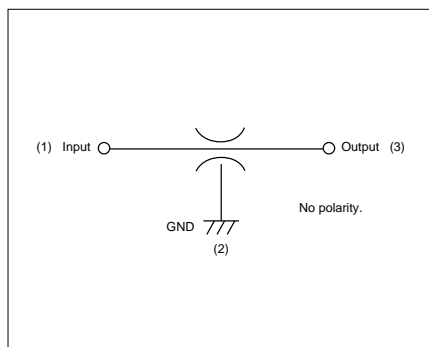

■ Insertion Loss Characteristics

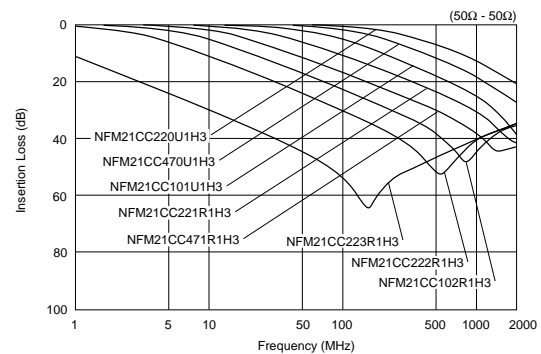

NFM3DC Series

The chip "EMIFIL" NFM3DC series is a chip type three terminal EMI suppression filter. It can reduce residual inductance to an extremely low level making it excellent for noise suppression at high frequencies.

■ Features

An electrostatic capacitance range of 22 to 22,000pF enables suppression of noise at specific frequencies.

■ Applications

High noise radiation and high impedance circuits such as digital circuits



NFM3DC Series

Part Number	Capacitance (pF)	Rated Voltage (Vdc)	Rated Current (mA)	Insulation Resistance (min.) (M ohm)	Operating Temperature Range (°C)
NFM3DCC220U1H3	22 +50%, -20%	50	300	1000	-55 to +125
NFM3DCC470U1H3	47 +50%, -20%	50	300	1000	-55 to +125
NFM3DCC101U1H3	100 +50%, -20%	50	300	1000	-55 to +125
NFM3DCC221R1H3	220 +50%, -20%	50	300	1000	-55 to +125
NFM3DCC471R1H3	470 +50%, -20%	50	300	1000	-55 to +125
NFM3DCC102R1H3	1000 +50%, -20%	50	300	1000	-55 to +125
NFM3DCC222R1H3	2200 +50%, -20%	50	300	1000	-55 to +125
NFM3DCC223R1H3	22000 +50%, -20%	50	300	1000	-55 to +125

2

■ Equivalent Circuit

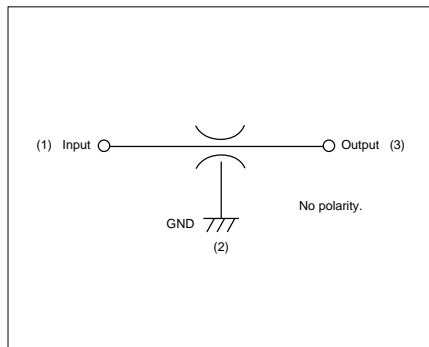

■ Insertion Loss Characteristics



NFM41C Series

The chip "EMIFIL" NFM41C series is a chip type three terminal EMI suppression filter. It can reduce residual inductance to an extremely low level making it excellent for noise suppression at high frequencies.

■ Features

An electrostatic capacitance range of 22 to 22,000pF enables suppression of noise at specific frequencies.

■ Applications

High noise radiation and high impedance circuits such as digital circuits



NFM41C Series

Part Number	Capacitance (pF)	Rated Voltage (Vdc)	Rated Current (mA)	Insulation Resistance (min.) (M ohm)	Operating Temperature Range (°C)
NFM41CC220U2A3	22 +50%, -20%	100	300	10000	-55 to +125
NFM41CC470U2A3	47 +50%, -20%	100	300	10000	-55 to +125
NFM41CC101U2A3	100 +50%, -20%	100	300	10000	-55 to +125
NFM41CC221U2A3	220 +50%, -20%	100	300	10000	-55 to +125
NFM41CC471R2A3	470 +50%, -20%	100	300	10000	-55 to +125
NFM41CC102R2A3	1000 +50%, -20%	100	300	10000	-55 to +125
NFM41CC222R2A3	2200 +50%, -20%	100	300	10000	-55 to +125
NFM41CC223R2A3	22000 +50%, -20%	100	300	10000	-55 to +125

■ Equivalent Circuit

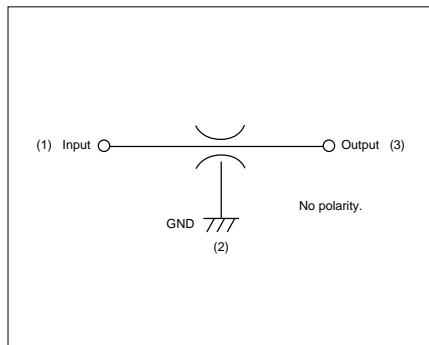

■ Insertion Loss Characteristics

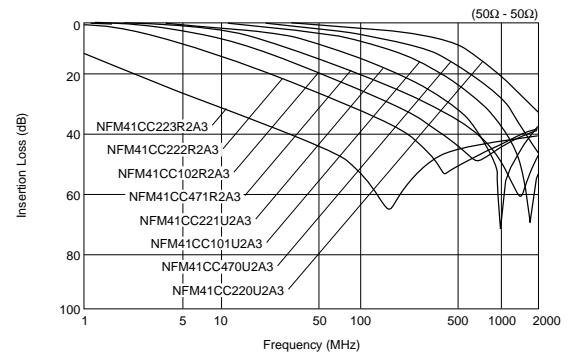

On-Board Type (DC) EMI Suppression Filters (EMIFIL®)



Chip EMIFIL® Capacitor Array Type NFA31C Series

NFA31C Series

NFA31C series is a chip EMI suppression filter for surface mount applications using Murata's ceramic processing technology and filter design technology. The series is well suited for EMI suppression in digital I/O lines of varied electronic equipment such as notebook size PCs.

■ Features

1. High density mounting can be realized because of 4 circuits in one package with 0.8mm pitch.
2. Suitable for high frequency noise suppression because of low residual inductance of three terminal structure.
3. Excellent EMI suppression can be realized because of two terminal simple GNDs for 4 circuits.
4. 22 to 22,000pF lineups can be used depending on noise frequency.

■ Applications

1. Personal computers and peripherals
2. Telephones, PPCs, communications equipment
3. Digital TVs, DVDs



NFA31C Series

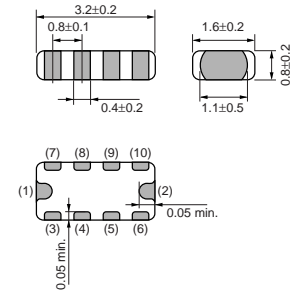

(in mm)

2

Part Number	Capacitance (pF)	Rated Voltage (Vdc)	Rated Current (mA)	Insulation Resistance (min.) (M ohm)	Operating Temperature Range (°C)
NFA31CC220S1E4	22 +20%, -20%	25	200	1000	-40 to +85
NFA31CC470S1E4	47 +20%, -20%	25	200	1000	-40 to +85
NFA31CC101S1E4	100 +20%, -20%	25	200	1000	-40 to +85
NFA31CC221S1E4	220 +20%, -20%	25	200	1000	-40 to +85
NFA31CC471R1E4	470 +20%, -20%	25	200	1000	-40 to +85
NFA31CC102R1E4	1000 +20%, -20%	25	200	1000	-40 to +85
NFA31CC222R1E4	2200 +20%, -20%	25	200	1000	-40 to +85
NFA31CC223R1C4	22000 +20%, -20%	16	200	1000	-40 to +85

Number of Circuits: 4

■ Equivalent Circuit

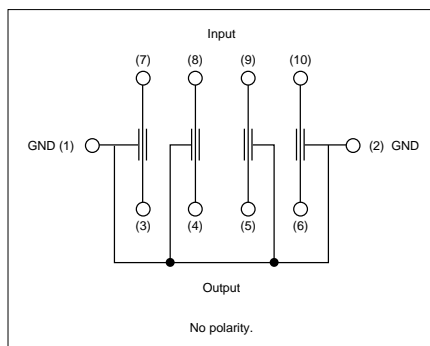

■ Insertion Loss Characteristics

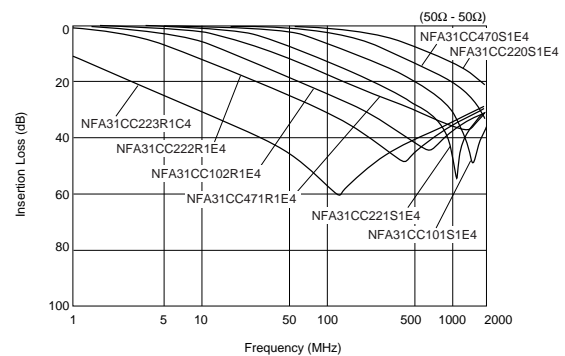

On-Board Type (DC) EMI Suppression Filters (EMIFIL®)



Chip EMIFIL® LC Combined Monolithic Type NFL18ST/18SP/21S Series

NFL18ST Series

NFL18ST series is an EMI suppression filter for high speed signal lines, achieving T-type structure in 1.6x0.8mm size with Murata's multilayer technology.

■ Features

1. Ultra-small size in 1.6x0.8x0.8mm
2. Steep insertion loss characteristics realize excellent noise suppression and prevent distortion of signal waveform.
3. By minimizing stray capacitance of inductor, achieves high performance in noise suppression in high frequency range.
4. Three different values of cut-off frequency are available, ranging from 200MHz up to 500MHz.
5. Since all side electrode structures are the same, it is no polarity.

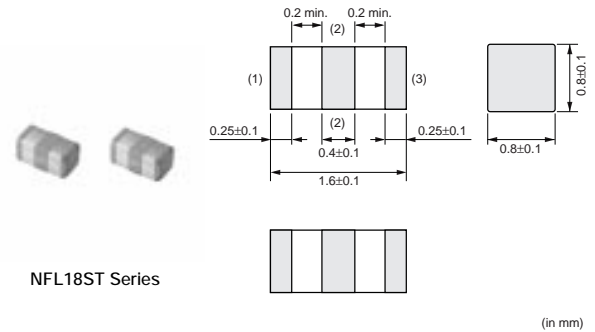

■ Applications

Noise suppression for video signal lines (RGB lines) and high speed clock lines

Part Number	Cut-off Frequency (MHz)	Capacitance (pF)	Inductance (nH)	Rated Voltage (Vdc)	Rated Current (mA)	Insulation Resistance (M ohm)	Operating Temperature Range (°C)
NFL18ST207X1C3	200	25 +20%, -20%	110 +20%, -20%	16	150	1000	-55 to 125
NFL18ST307X1C3	300	18 +20%, -20%	62 +20%, -20%	16	200	1000	-55 to 125
NFL18ST507X1C3	500	10 +20%, -20%	43 +20%, -20%	16	200	1000	-55 to 125

Number of Circuits: 1

■ Equivalent Circuit

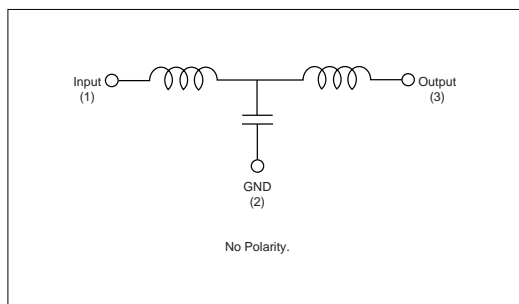

■ Insertion Loss Characteristics

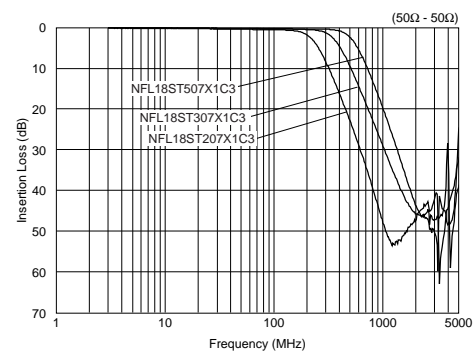

NFL18SP Series

The chip "EMIFIL" NFL18SP series is an EMI Suppression filter for high speed signal lines, achieving pi-type structure in 0603 size with Murata's multilayer technology.

■ Features

1. Ultra-small size in 1.6x0.8x0.6 mm
2. Achieves high performance in noise suppression over wide frequency range
3. Steep insertion loss characteristics realize excellent noise suppression and prevent distortion of signal waveform.
4. Line up 4 items of cut-off frequency range from 150 to 500MHz

■ Applications

EMI suppression for digital signal line such as RGB and high speed clock lines



2

Part Number	Cut-off Frequency (MHz)	Capacitance (pF)	Inductance (nH)	Rated Voltage (Vdc)	Rated Current (mA)	Insulation Resistance (M ohm)	Operating Temperature Range (°C)
NFL18SP157X1A3	150	34 +20%, -20%	100 +20%, -20%	10	100	1000	-55 to 125
NFL18SP207X1A3	200	24 +20%, -20%	80 +20%, -20%	10	100	1000	-55 to 125
NFL18SP307X1A3	300	19 +20%, -20%	60 +20%, -20%	10	100	1000	-55 to 125
NFL18SP507X1A3	500	11 +20%, -20%	38 +20%, -20%	10	100	1000	-55 to 125

Number of Circuits: 1

■ Equivalent Circuit

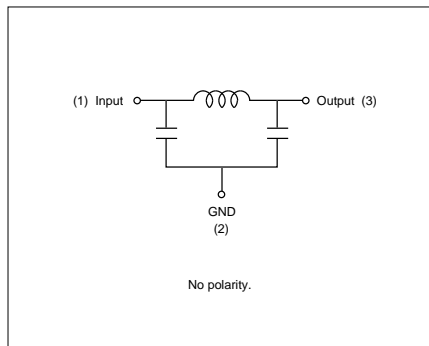

■ Insertion Loss Characteristics

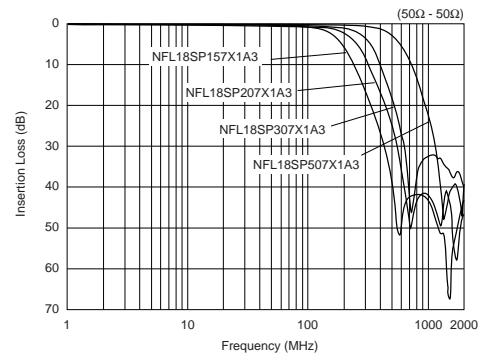

NFL21S Series

The chip "EMIFIL" NFL21S series is a high performance EMI suppression filter in 2.0x1.25mm size for high speed signal lines by using Murata's processing technology.

■ Features

1. Suppresses noise with little attenuation of the signal itself due to its steep filtering characteristics.
2. Murata's original internal structure design enables excellent noise suppression up to high frequencies.
3. Available in ten different values of cut-off frequency ranging from 10MHz up to 500MHz.

■ Applications

Suppression of high magnitude radiated noise generated by high speed digital circuits such as clock and RGB

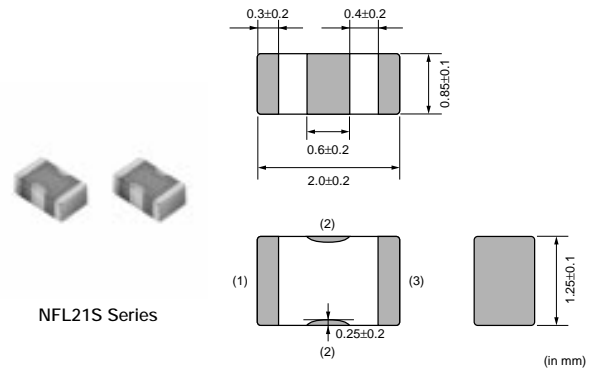

Part Number	Cut-off Frequency (MHz)	Capacitance (pF)	Inductance (nH)	Rated Voltage (Vdc)	Rated Current (mA)	Insulation Resistance (M ohm)	Operating Temperature Range (°C)
NFL21SP106X1C3	10	670 +20%, -20%	680 +20%, -20%	16	100	1000	-55 to 125
NFL21SP206X1C7	20	240 +20%, -20%	700 +20%, -20%	16	100	1000	-55 to 125
NFL21SP506X1C3	50	84 +20%, -20%	305 +20%, -20%	16	150	1000	-55 to 125
NFL21SP706X1C3	70	76 +20%, -20%	185 +20%, -20%	16	150	1000	-55 to 125
NFL21SP107X1C3	100	44 +20%, -20%	135 +20%, -20%	16	200	1000	-55 to 125
NFL21SP157X1C3	150	28 +20%, -20%	128 +20%, -20%	16	200	1000	-55 to 125
NFL21SP207X1C3	200	22 +20%, -20%	72 +20%, -20%	16	250	1000	-55 to 125
NFL21SP307X1C3	300	19 +10%, -10%	45 +10%, -10%	16	300	1000	-55 to 125
NFL21SP407X1C3	400	16 +10%, -10%	34 +10%, -10%	16	300	1000	-55 to 125
NFL21SP507X1C3	500	12 +10%, -10%	31 +10%, -10%	16	300	1000	-55 to 125

Number of Circuits: 1

■ Equivalent Circuit

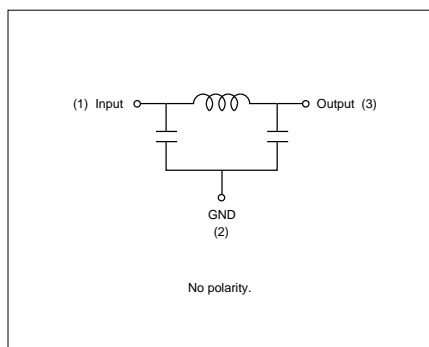

■ Insertion Loss Characteristics

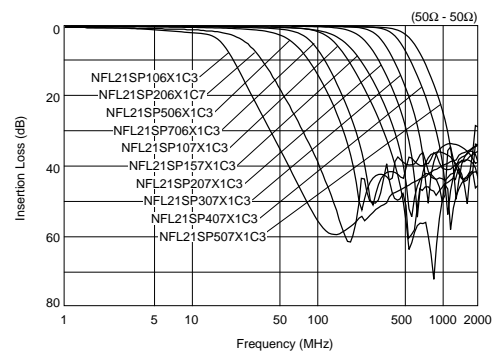

On-Board Type (DC) EMI Suppression Filters (EMIFIL®)



Chip EMIFIL® LC Combined Array Type NFA18S/21S Series

NFA18S Series

■ Features

1. NFA18SL series is LC combined noise suppression filter whose noise suppression curve is very steep and deep in spite of its small shape.
2. [cutoff frequency 300MHz, 400MHz, 480MHz type]
These products have good noise suppression effect at the frequency range over 800MHz which is important for sensitivity of mobile phones, and suppress radiation noise from LCD lines or camera module lines very well.
[cutoff frequency 130MHz, 180MHz, 200MHz type]
These products have good noise suppression effect at UHF range in addition to 800MHz range.
This characteristics works well at noise suppression for improvement of sensitivity at digital TVs.
3. Various cutoff frequency is available to control signal rise speed and signal fall speed.
4. circuits are built in 1.6x0.8mm chip size, it saves the large amount of mounting space.

■ Application

Noise suppression of LCD signal lines, camera module lines.

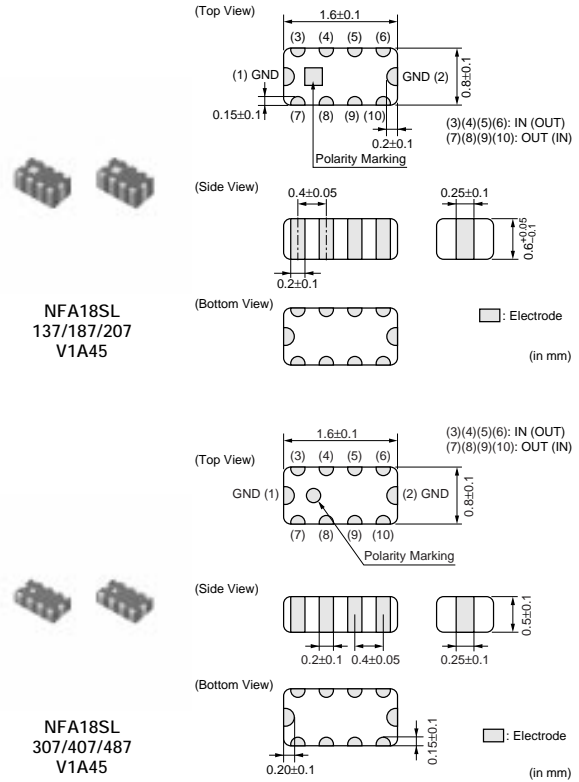

Part Number	Cut-off Frequency (MHz)	Insertion Loss at Cut-off Frequency (dB)	Insertion Loss at 470MHz (min.) (dB)	Insertion Loss at 800MHz (min.) (dB)	Insertion Loss at 900MHz (min.) (dB)	Insulation Resistance (min.) (M ohm)	Rated Voltage (Vdc)	Rated Current (mA)	Withstand Voltage (Vdc)
NFA18SL137V1A45	130	6 max	25	-	25	1000	10	50	30
NFA18SL187V1A45	180	6 max	20	-	20	1000	10	50	30
NFA18SL207V1A45	200	6 max	15	-	15	1000	10	50	30
NFA18SL307V1A45	300	6 max	-	20	20	1000	10	100	30
NFA18SL407V1A45	400	6 max	-	18	18	1000	10	100	30
NFA18SL487V1A45	480	6 max	-	15	15	1000	10	100	30

Operating Temperature Range: -40°C to +85°C Number of Circuits: 4

■ Equivalent Circuit

NFA18SL 137/187/207 V1A45

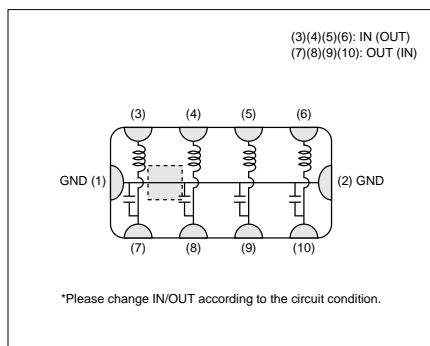

NFA18SL 307/407/487 V1A45

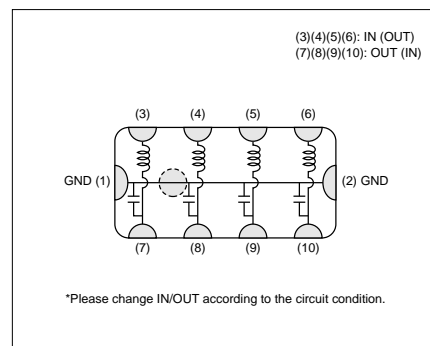

Continued on the following page.

Continued from the preceding page.

Insertion Loss Characteristics

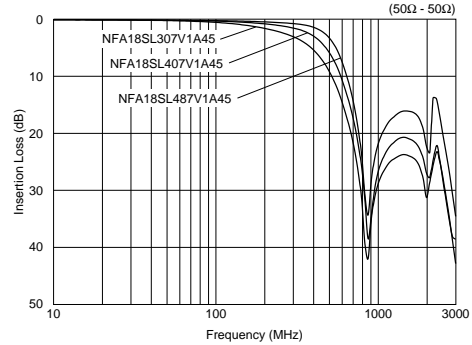

2

NFA21S Series

Features

1. Steep insertion loss characteristics
2. Suitable for noise suppression in 800MHz or higher frequency
3. Size: 2.0x1.25mm
4. 4 circuits in one package

Applications

Noise suppression for LCD line



Part Number	Cut-off Frequency (MHz)	Insertion Loss at Cut-off Frequency (dB)	Insertion Loss at 500MHz (min.) (dB)	Insertion Loss at 800MHz (min.) (dB)	Insertion Loss at 900MHz (min.) (dB)	Insertion Loss at 1000MHz (min.) (dB)	Insulation Resistance (M ohm)	Rated Voltage (Vdc)	Rated Current (mA)	Withstand Voltage (Vdc)
NFA21SL506X1A48	50	0 to 6	30	-	-	20	1000	10	20	30
NFA21SL806X1A48	80	2 to 7	25	-	-	25	1000	10	20	30
NFA21SL207X1A45	200	2 to 7	13	25	-	25	1000	10	100	30
NFA21SL207X1A48	200	2 to 7	13	25	-	25	1000	10	100	30
NFA21SL307X1A45	300	2 to 7	7	20	-	25	1000	10	100	30
NFA21SL307X1A48	300	2 to 7	7	20	-	25	1000	10	100	30
NFA21SL287V1A45	280	6 max	-	25	25	-	1000	10	100	30
NFA21SL287V1A48	280	6 max	-	25	25	-	1000	10	100	30
NFA21SL317V1A45	310	6 max	-	20	20	-	1000	10	100	30
NFA21SL317V1A48	310	6 max	-	20	20	-	1000	10	100	30
NFA21SL337V1A45	330	6 max	-	15	15	-	1000	10	100	30
NFA21SL337V1A48	330	6 max	-	20	20	-	1000	10	100	30

Operating Temperature Range: -55°C to +125°C Number of Circuits: 4

■ Equivalent Circuit



■ Insertion Loss Characteristics

NFA21SL_X Series

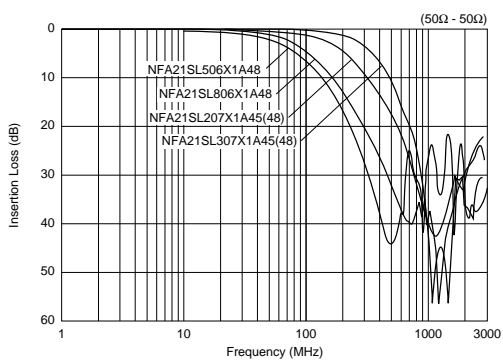

NFA21SL_V_48 Series

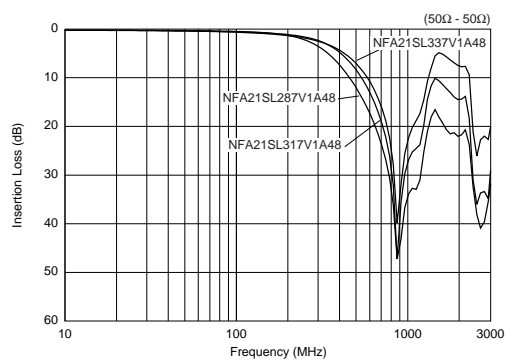

NFA21SL_V_45 Series

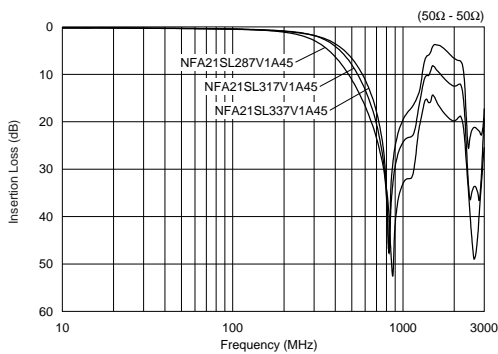

2

On-Board Type (DC) EMI Suppression Filters (EMIFIL®)



Chip EMIFIL® LC Combined Wire Wound Type NFW31S Series

NFW31S Series

The signal line chip EMI filter NFW31S series consists of high performance EMI suppression filters. They are designed for noise suppression in high speed signal digital circuits in which the signal harmonics are prone to becoming noise sources. These filters achieve a 100dB/dec. (typ.) damping characteristic with Murata's innovative circuit design. This makes these chips effective in applications where the signal and noise frequencies are close to each other.

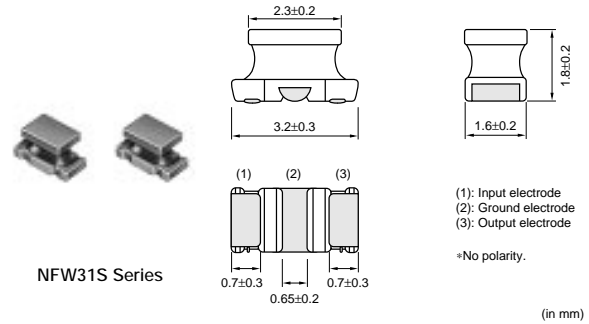

2

■ Features

1. Suppresses signal noise with little or no attenuation of the signal itself.
2. Murata's original internal structure design enables excellent noise suppression up to high frequencies (40dB at 1GHz typ.).
3. NFW31S series is available in 9 different values of cut-off frequency ranging from 10MHz up to 500MHz.

Part Number	Nominal Cut-off Freq. (MHz)	Attenuation at 10MHz (dB)	Attenuation at 20MHz (dB)	Attenuation at 50MHz (dB)	Attenuation at 100MHz (dB)	Attenuation at 150MHz (dB)	Attenuation at 200MHz (dB)	Attenuation at 300MHz (dB)	Attenuation at 400MHz (dB)	Attenuation at 500MHz (dB)	Attenuation at 1000MHz (dB)
NFW31SP106X1E4	10	6 max.	5 min.	25 min.	25 min.	-	25 min.	-	-	30 min.	30 min.
NFW31SP206X1E4	20	-	6 max.	5 min.	25 min.	-	25 min.	-	-	30 min.	30 min.
NFW31SP506X1E4	50	-	-	6 max.	10 min.	-	30 min.	-	-	30 min.	30 min.
NFW31SP107X1E4	100	-	-	-	6 max.	-	5 min.	-	-	20 min.	30 min.
NFW31SP157X1E4	150	-	-	-	-	6 max.	-	10 min.	20 min.	30 min.	30 min.
NFW31SP207X1E4	200	-	-	-	-	-	6 max.	-	-	10 min.	30 min.
NFW31SP307X1E4	300	-	-	-	-	-	-	6 max.	-	5 min.	15 min.
NFW31SP407X1E4	400	-	-	-	-	-	-	-	6 max.	-	10 min.
NFW31SP507X1E4	500	-	-	-	-	-	-	-	-	6 max.	10 min.

Rated Current: 200mA Rated Voltage: 25Vdc Operating Temperature Range: -40°C to 85°C

■ Equivalent Circuit



■ Insertion Loss Characteristics



Noise Suppression Effect of NFW31S Series

Example of EMI Suppression in an Actual Circuit

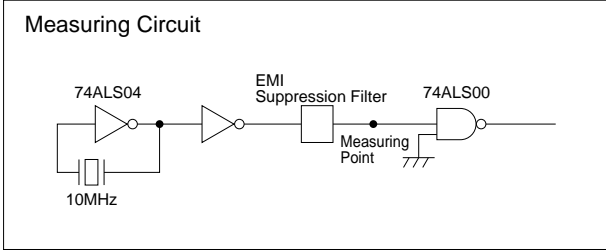

Type of Filter	Signal Wave Form (20ns/div, 1V/div)	EMI Suppression Effect	Description
Signal Waveform and Noise Spectrum before Filter Mounting	 Signal Waveform (20ns/div, 1V/div)	 Noise Spectrum (10:1 Active Probe)	
NFW31S Series (Cut-off frequency 50MHz)	 Signal Waveform (20ns/div, 1V/div)	 Noise Level (dBμV) vs Frequency (MHz). Level before filter mounting is shown as a dashed line.	NFW31S's steep attenuation characteristic means excellent EMI suppression without waveform cornering.
Conventional Chip Solid Type EMI Filter (NFM41CC 470pF)	 Signal Waveform (20ns/div, 1V/div)	 Noise Level (dBμV) vs Frequency (MHz). Level before filter mounting is shown as a dashed line.	3-terminal capacitors suppress signal frequencies as EMI frequencies so the signal waveform is distorted.
Filter Combined with Conventional LCs	 Signal Waveform (20ns/div, 1V/div)	 Noise Level (dBμV) vs Frequency (MHz). Level before filter mounting is shown as a dashed line.	Combinations of inductors and capacitors can yield a steep attenuation characteristic, but they require a great deal more mounting space. Moreover, at high frequencies the EMI suppression is less than that obtained by NFW31S.

On-Board Type (DC) EMI Suppression Filters (EMIFIL®)



Chip EMIFIL® RC Combined Type NFR21G Series

NFR21G Series

NFR21G series is comprised of high performance EMI suppression filters which can suppress distortion of waveform. Various items are to be used, considering circuit impedance and noise condition.

■ Features

1. Murata's original inner design realizes small and low profile of 2.0x1.25x0.5mm.
2. Distributed constant circuit realizes smooth change of impedance which prevents reflection of signal and distortion of wave shape.
3. NFR21G series is effective in a line where ground is not stable, because the resistance element in the filter absorbs noise and returns it to ground line.
4. NFR21G series has no polarity so it can be used in dual direction transport lines.
5. NFR21G series has various lineups of resistance (22 to 100 ohm) and capacitance (10 to 100pF).

■ Applications

Interface lines and clock lines where signals tend to be distorted



NFR21G Series

Part Number	Capacitance (pF)	Resistance (ohm)	Rated Current (mA)	Rated Voltage (Vdc)	Insulation Resistance (M ohm)	Operating Temperature Range (°C)
NFR21GD1002202	10 +20%,-20%	22 +30%,-30%	50	50	1000	-40 to 85
NFR21GD1004702	10 +20%,-20%	47 +30%,-30%	35	50	1000	-40 to 85
NFR21GD4702202	47 +20%,-20%	22 +30%,-30%	50	50	1000	-40 to 85
NFR21GD4704702	47 +20%,-20%	47 +30%,-30%	35	50	1000	-40 to 85
NFR21GD4706802	47 +20%,-20%	68 +30%,-30%	30	50	1000	-40 to 85
NFR21GD4701012	47 +20%,-20%	100 +30%,-30%	25	50	1000	-40 to 85
NFR21GD1012202	100 +20%,-20%	22 +30%,-30%	50	50	1000	-40 to 85
NFR21GD1014702	100 +20%,-20%	47 +30%,-30%	35	50	1000	-40 to 85
NFR21GD1016802	100 +20%,-20%	68 +30%,-30%	30	50	1000	-40 to 85
NFR21GD1011012	100 +20%,-20%	100 +30%,-30%	25	50	1000	-40 to 85

Number of Circuits: 1

■ Equivalent Circuit



■ Insertion Loss Characteristics

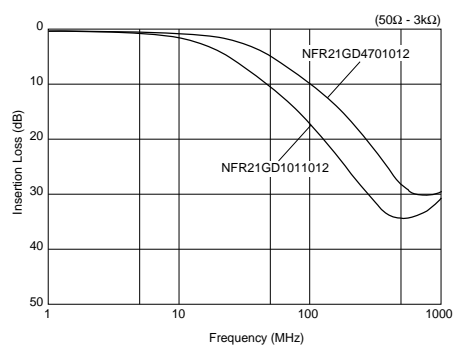
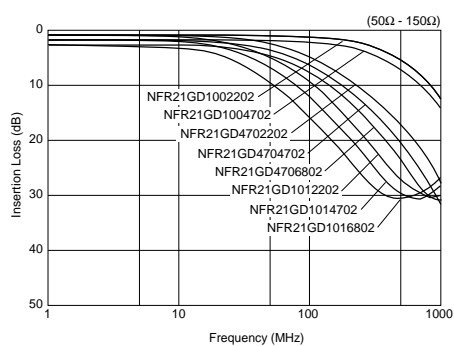

2

Noise Suppression Effect of NFR21G Series

■ Effect of Noise Suppression by NFR21G

NFR21G is effective even if ground line is not stable enough due to its distributed constant circuit structure.

Testing Circuit

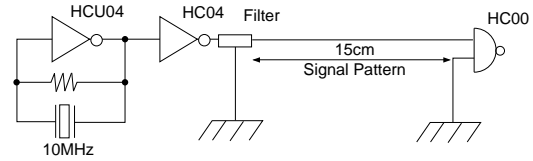

With Stable Ground Line

Type of Filter	EMI Suppression Effect	Description
Noise Level without Filter		
Filter Mounting Condition Standard Type Chip EMIFIL® (100pF)		The standard type chip EMIFIL® is effective on stable ground lines.
Filter Mounting Condition NFR21GD4701012		NFR21G has some advantages to standard type EMIFIL® on stable ground lines.

With Poor Ground Line

Type of Filter	EMI Suppression Effect	Description
Noise Level without Filter		
Filter Mounting Condition Standard Type Chip EMIFIL® (100pF)		The standard type EMIFIL® loses efficiency on poor ground lines.
Filter Mounting Condition NFR21GD4701012		NFR21G is effective even on poor ground lines because of its distributed constant circuit structure and unique system to limit rush current.

Noise Suppression Effect of NFR21G Series

■ Waveform Distortion Suppressing Function by NFR21G

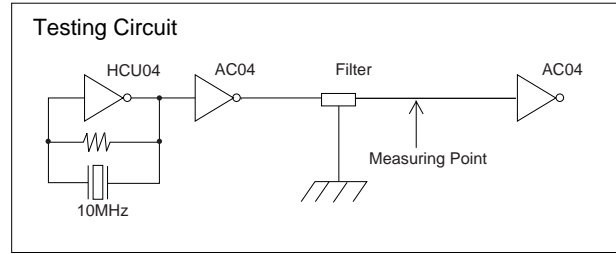

Type of Filter	EMI Suppression Effect	Description
Initial Waveform (no filter)	<p style="text-align: center;">Voltage Waveform</p> <p style="text-align: center;">↑ :1V/div → :20ns/div</p>	<p>Resonance between the internal capacitance of the IC and the inductance of the print pattern causes waveform overshooting and undershooting.</p>
When Ordinary Capacitor Filter is Used	<p style="text-align: center;">Voltage Waveform</p> <p style="text-align: center;">↑ :1V/div → :20ns/div</p>	<p>Ordinary capacitor filters have no waveform distortion suppressing capability, and they cannot suppress disturbances in the waveforms.</p>
NFR21G	<p style="text-align: center;">Voltage Waveform</p> <p style="text-align: center;">↑ :1V/div → :20ns/div</p>	<p>The waveform distortion suppressing function of NFR21G minimizes disturbances of waveforms.</p>

2

On-Board Type (DC) EMI Suppression Filters (EMIFIL®)



Chip EMIFIL® RC Combined Array Type NFA31G Series

NFA31G Series

NFA31G series is a high performance EMI suppression filter array with a 4-circuit noise filter in 3.2x1.6mm size. NFA31G realizes high density mounting.

■ Features

1. NFA31G is a 4-circuit noise filter in 3.2x1.6mm size with 0.8mm pitch. High density mounting is available.
2. Three terminal structure enables excellent high frequency performance.
3. Distributed constant circuit realizes smooth change of impedance which prevents reflection of signal and distortion of wave shape.
4. NFA31G series is effective in lines where ground is not stable, because the resistance element in the filter absorbs noise and returns it to ground line.



NFA31G Series



2

Part Number	Capacitance (pF)	Resistance (ohm)	Rated Current (mA)	Rated Voltage (Vdc)	Insulation Resistance (M ohm)	Operating Temperature Range (°C)
NFA31GD1006R84	10 +20%,-20%	6.8 +40%,-40%	50	6	1000	-40 to 85
NFA31GD1004704	10 +20%,-20%	47 +30%,-30%	20	6	1000	-40 to 85
NFA31GD1001014	10 +20%,-20%	100 +30%,-30%	15	6	1000	-40 to 85
NFA31GD4706R84	47 +20%,-20%	6.8 +40%,-40%	50	6	1000	-40 to 85
NFA31GD4703304	47 +20%,-20%	33 +30%,-30%	20	6	1000	-40 to 85
NFA31GD4704704	47 +20%,-20%	47 +30%,-30%	20	6	1000	-40 to 85
NFA31GD4701014	47 +20%,-20%	100 +30%,-30%	15	6	1000	-40 to 85
NFA31GD1016R84	100 +20%,-20%	6.8 +40%,-40%	50	6	1000	-40 to 85
NFA31GD1014704	100 +20%,-20%	47 +30%,-30%	20	6	1000	-40 to 85
NFA31GD1011014	100 +20%,-20%	100 +30%,-30%	15	6	1000	-40 to 85

Number of Circuits: 4

■ Equivalent Circuit

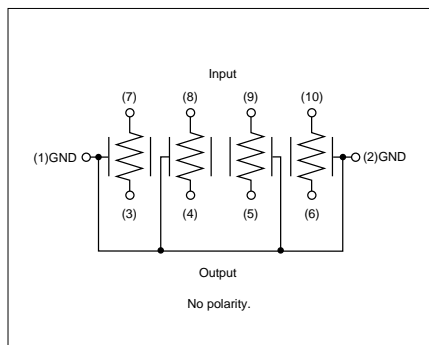

■ Insertion Loss Characteristics



2

On-Board Type (DC) EMI Suppression Filters (EMIFIL®)



Chip EMIFIL® for Large Current NFM18P/21P/3DP/31P/41P/55P Series

NFM18PS Series

■ Features

1. Excellent noise suppression characteristics in high frequency band.
2. Rated current of 2A is achieved in small size of 1.6x0.8mm.
3. Suitable for noise suppression in IC power line.

■ Applications

For IC power lines of digital equipment such as DVDs, DSCs, Mobile Phones, Digital TVs

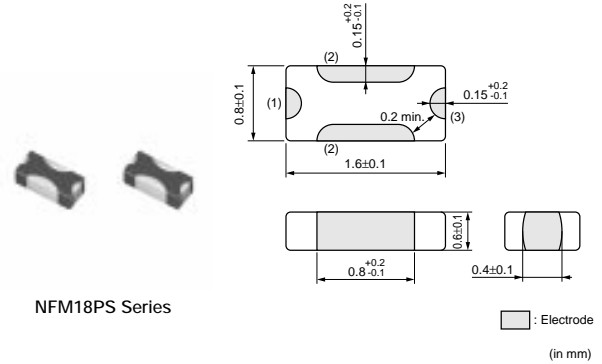

NFM18PS Series

Part Number	Capacitance (μF)	Rated Voltage (Vdc)	Rated Current (A)	Insulation Resistance (min.) (M ohm)	Operating Temperature Range (°C)
NFM18PS474R0J3	0.47 +20%,-20%	6.3	2	1000	-55 to +125
NFM18PS105R0J3	1.0 +20%,-20%	6.3	2	500	-55 to +105

■ Equivalent Circuit

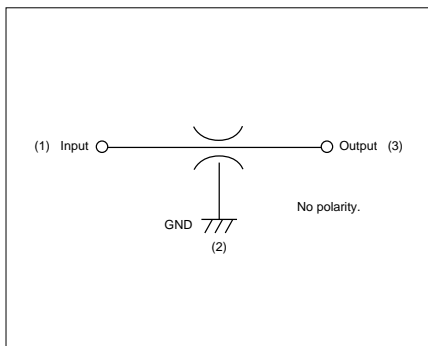

■ Insertion Loss Characteristics

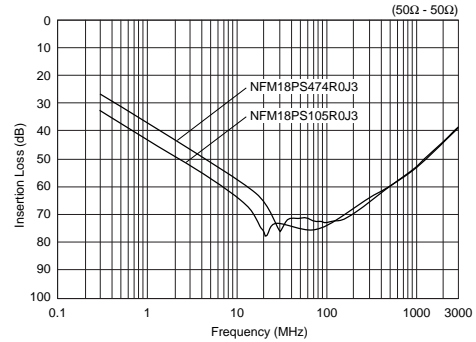

NFM18PC Series

NFM18PC series is a high performance EMI suppression filter in 1.6x0.8mm size for high-speed IC power supply lines by using Murata processing technology.

■ Features

1. Ultra-small size in 1.6x0.8mm
 2. Three terminal structure with low residual (ESL)* and large capacitance 2.2 micro F (max.) realize large insertion loss characteristics over wide frequency range.
 3. Large rated current 4A max. is suitable for noise suppression of circuits which require large current.
 4. NFM18PC series has line up of capacitance 0.1 to 2.2 micro F.
- * Not exceeding one-tenth of monolithic ceramic capacitors (two terminal).

■ Applications

1. Noise suppression for large capacitance circuits such as high speed IC power lines
2. Control change of voltage for high speed IC

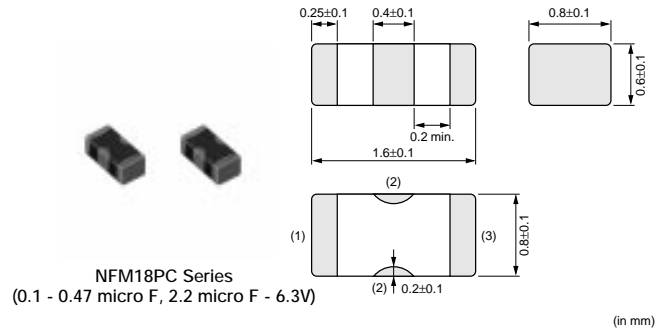
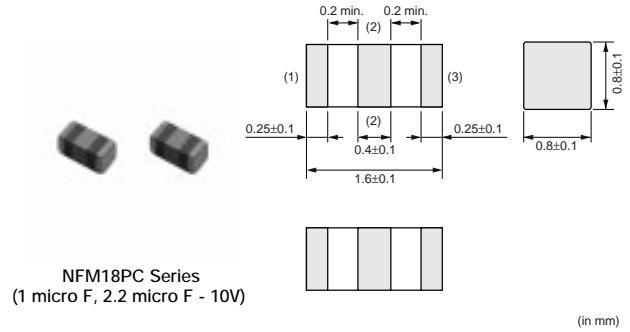

Part Number	Capacitance (μF)	Rated Voltage (Vdc)	Rated Current (A)	Insulation Resistance (min.) (M ohm)	Operating Temperature Range (°C)
NFM18PC104R1C3	0.1 +20%, -20%	16	2	1000	-55 to +125
NFM18PC224R0J3	0.22 +20%, -20%	6.3	2	1000	-55 to +125
NFM18PC474R0J3	0.47 +20%, -20%	6.3	2	1000	-55 to +125
NFM18PC105R0J3	1.0 +20%, -20%	6.3	2	500	-55 to +105
NFM18PC225B0J3	2.2 +20%, -20%	6.3	2	200	-40 to +85
NFM18PC225B1A3	2.2 +20%, -20%	10	4	200	-40 to +85

■ Equivalent Circuit

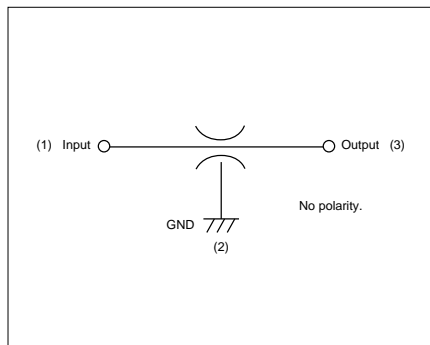

■ Insertion Loss Characteristics

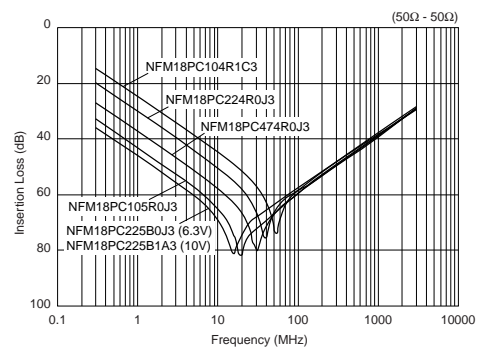

NFM21P Series

NFM21P is a three terminal structure component. This product can be applied to large current DC power lines. NFM21P is suitable for noise suppression of DC power lines where relatively large current operates.

■ Features

1. The rated current of 6A max. is suitable for IC's individual power lines.
2. Small dimension enables higher density packaging. NFM21P is much smaller size (2.0x1.25x0.85mm).
3. Murata's original internal electrode structure design realizes excellent EMI suppression effects from low frequency to high frequency.

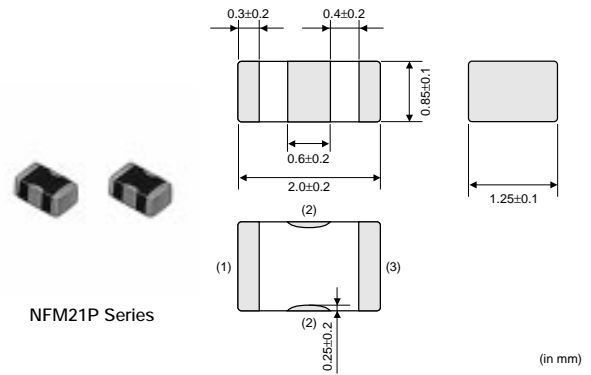

2

Part Number	Capacitance (μF)	Rated Voltage (Vdc)	Rated Current (A)	Insulation Resistance (min.) (M ohm)	Operating Temperature Range (°C)
NFM21PC104R1E3	0.1 +20%,-20%	25	2	1000	-55 to +125
NFM21PC224R1C3	0.22 +20%,-20%	16	2	1000	-55 to +125
NFM21PC474R1C3	0.47 +20%,-20%	16	2	1000	-55 to +125
NFM21PC105B1A3	1.0 +20%,-20%	10	4	500	-40 to +85
NFM21PC105B1C3	1.0 +20%,-20%	16	4	500	-40 to +85
NFM21PC225B0J3	2.2 +20%,-20%	6.3	4	200	-40 to +85
NFM21PC475B1A3	4.7 +20%,-20%	10	6	100	-40 to +85

■ Equivalent Circuit

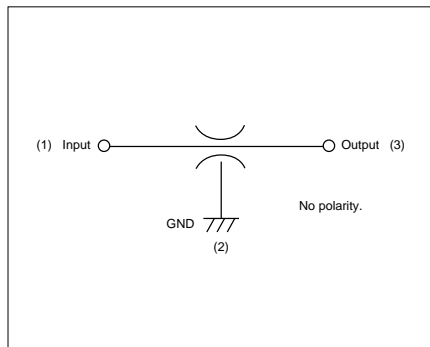

■ Insertion Loss Characteristics

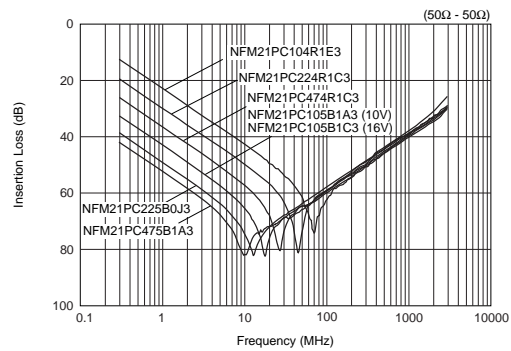

NFM3DP Series

The chip "EMIFIL" NFM3DP is a chip type three terminal capacitor with high rated current of 2A. This series is suited for noise suppression in DC power supply lines of digital instruments.

■ Features

1. Large rated current (2A) is suitable for application in DC power lines.
2. Small size (3.2x1.25mm) and low profile (0.7mm max.)

■ Applications

1. Personal computers, word processors and peripherals
2. Telephones, PPCs, communication equipment, etc.
3. Digital TVs, DVDs
4. Telecommunications equipment



NFM3DP Series

Part Number	Capacitance (μF)	Rated Voltage (Vdc)	Rated Current (A)	Insulation Resistance (min.) (M ohm)	Operating Temperature Range (°C)
NFM3DPC223R1H3	0.022 +20%,-20%	50	2	1000	-55 to +125

In operating temperatures exceeding +85°C, derating of current is necessary.

■ Equivalent Circuit

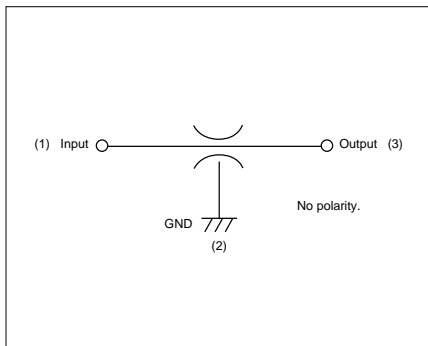

■ Insertion Loss Characteristics



■ Notice (Rating)

When NFM3DP series is used in operating temperatures exceeding +85°C, derating of current is necessary. Please apply the derating curve shown in chart according to the operating temperature.

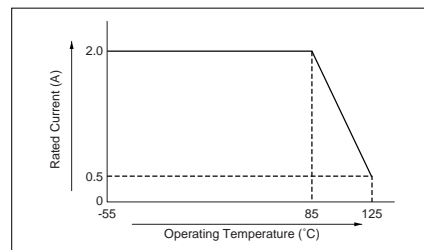

NFM31P Series

NFM31P series is EMI suppression filter for power lines of high speed IC with high capacitance (27uF) and large rated current (6A) in 3.2x1.6mm chip size, which is realized using Murata's high level multilayer processing technology.

■ Feature

1. Low ESL characteristics and high capacitance of 27uF due to its 3-terminal structure, realizes high noise suppression effect from low frequency to high frequency.
It is suitable as decoupling capacitor for broad frequency range.
2. Large rated current of 6A is suitable for noise suppression in power lines of high speed IC which need large current capacity.

■ Application

1. EMI suppression for high noise level circuit which need large current capacity such as IC power lines.
2. Stabilization of power line voltage in high speed ICs.

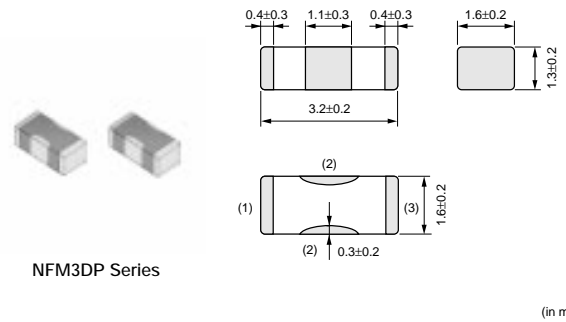

2

Part Number	Capacitance (μF)	Rated Voltage (Vdc)	Rated Current (A)	Insulation Resistance (min.) (M ohm)	Operating Temperature Range (°C)
NFM31PC276B0J3	27 +20%,-20%	6.3	6	20	-40 to +85

■ Equivalent Circuit

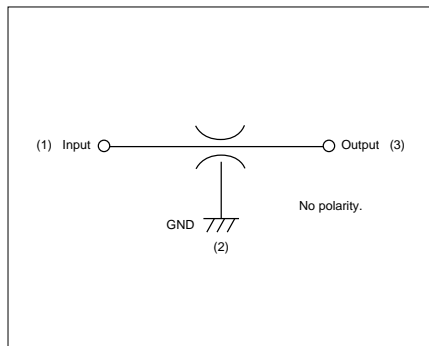

■ Insertion Loss Characteristics

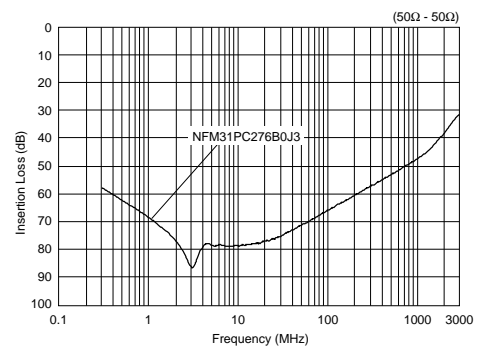

NFM41P Series

The chip "EMIFIL" NFM41P series consists of three terminal structure. These components are able to be applied to large current DC power lines. NFM41P series are suitable in noise suppression in DC lines where relatively large currents operate.

■ Features

1. Large rated current 6A (max.) is suitable for the application in DC power lines.
2. High electrostatic capacitance and remarkable high frequency performance are effective for immunity against surge noise and pulse noise.

■ Applications

1. Personal computers, word processors and peripherals
2. Telephones, PPCs, communication equipment, etc.
3. Digital TVs, DVDs
4. Telecommunications equipment



NFM41P Series

Part Number	Capacitance (μF)	Rated Voltage (Vdc)	Rated Current (A)	Insulation Resistance (min.) (M ohm)	Operating Temperature Range (°C)
NFM41PC204F1H3	0.2 +80%, -20%	50	2	1000	-55 to +85
NFM41PC155B1E3	1.5 +20%, -20%	25	6	300	-55 to +85

■ Equivalent Circuit

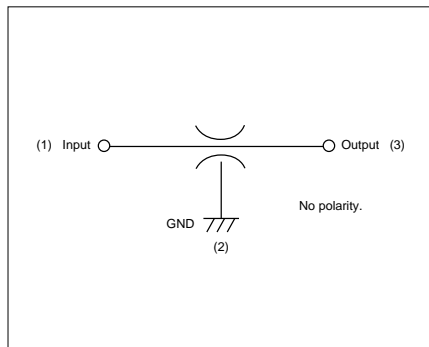

■ Insertion Loss Characteristics



NFM55P Series

The chip solid "EMIFIL" NFM55P is a chip type three terminal capacitor with high rated current of 6A. This series is suited for noise suppression in DC power lines where high rated current and large capacitance is required.

■ Features

1. Large rated current (6A) and low voltage drop due to a small DC resistance (0.01 ohm) are suitable for the application in DC power line.
2. High electrostatic capacitance and remarkable high frequency performance are effective for the immunity against the surge noise and the pulse noise.
3. Only reflow soldering should be applied.

■ Applications

1. Personal computers, word processors and peripherals
2. Telephones, PPCs, communication equipment, etc.
3. Digital TVs, DVDs
4. Telecommunications equipment



NFM55P Series

2

Part Number	Capacitance (μF)	Rated Voltage (Vdc)	Rated Current (A)	Insulation Resistance (min.) (M ohm)	Operating Temperature Range (°C)
NFM55PC155F1H4	1.5 +80%, -20%	50	6	100	-55 to +85

■ Equivalent Circuit



■ Insertion Loss Characteristics



On-Board Type (DC) EMI Suppression Filters (EMIFIL®)



Chip EMIFIL® LC Combined Type for Large Current NFE31P/61P Series

NFE31P Series

The chip "EMIFIL" NFE31P is a small size T-type circuit EMI suppression filter.

■ Features

1. Its large rated current of 6A and low voltage drop due to small DC resistance are suitable for DC power line use.
2. The feedthrough capacitor realizes excellent high frequency characteristics.
3. The structure incorporates built-in ferrite beads which minimize resonance with surrounding circuits.
4. 22 to 2,200pF lineups can be used in signal lines.

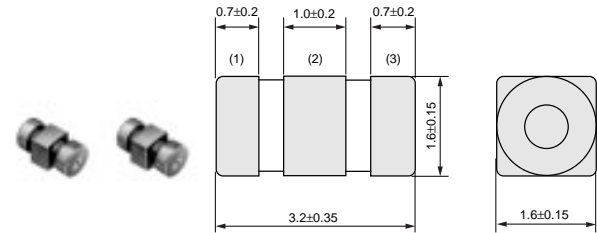

NFE31P Series

(in mm)

2

Part Number	Capacitance (pF)	Rated Voltage (Vdc)	Rated Current (A)	Insulation Resistance (min.) (M ohm)	Operating Temperature Range (°C)
NFE31PT220R1E9	22 +30%, -30%	25	6	1000	-40 to +85
NFE31PT470C1E9	47 +50%, -20%	25	6	1000	-40 to +85
NFE31PT101C1E9	100 +80%, -20%	25	6	1000	-40 to +85
NFE31PT221D1E9	220 +50%, -20%	25	6	1000	-40 to +85
NFE31PT471F1E9	470 +50%, -20%	25	6	1000	-40 to +85
NFE31PT152Z1E9	1500 +50%, -20%	25	6	1000	-40 to +85
NFE31PT222Z1E9	2200 +50%, -50%	25	6	1000	-40 to +85

■ Equivalent Circuit



■ Insertion Loss Characteristics



NFE61P Series

The chip "EMIFIL" NFE61P is a T-type circuit EMI suppression filter.

■ Features

1. Its large rated current of 2A and low voltage drop due to small DC resistance are suitable for DC power line use.
2. The feedthrough capacitor realizes excellent high frequency characteristics.
3. The structure incorporates built-in ferrite beads which minimize resonance with surrounding circuits.
4. 33 to 4,700pF lineups can be used in signal lines.

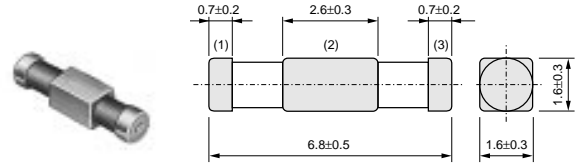

NFE61P Series

(in mm)

2

Part Number	Capacitance (pF)	Rated Voltage (Vdc)	Rated Current (A)	Insulation Resistance (min.) (M ohm)	Operating Temperature Range (°C)
NFE61PT330B1H9	33 +30%, -30%	50	2	1000	-25 to +85
NFE61PT680B1H9	68 +30%, -30%	50	2	1000	-25 to +85
NFE61PT101Z1H9	100 +30%, -30%	50	2	1000	-25 to +85
NFE61PT181B1H9	180 +30%, -30%	50	2	1000	-25 to +85
NFE61PT361B1H9	360 +20%, -20%	50	2	1000	-25 to +85
NFE61PT681B1H9	680 +30%, -30%	50	2	1000	-25 to +85
NFE61PT102E1H9	1000 +80%, -20%	50	2	1000	-25 to +85
NFE61PT472C1H9	4700 +80%, -20%	50	2	1000	-25 to +85

■ Equivalent Circuit

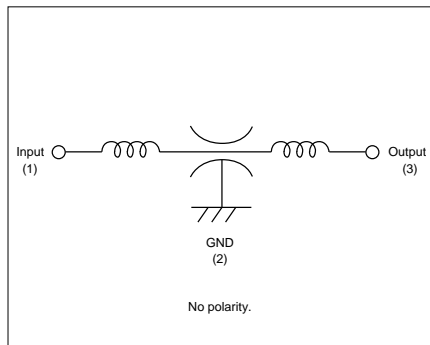

■ Insertion Loss Characteristics

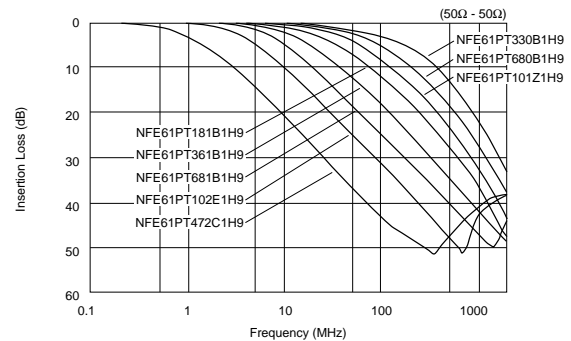

On-Board Type (DC) EMI Suppression Filters (EMIFIL®)



Chip Common Mode Choke Coils Part Numbering

Chip Common Mode Choke Coils

(Part Number)

DL	W	21	S	N	371	S	Q	2	L
①	②	③	④	⑤	⑥	⑦	⑧	⑨	⑩

① Product ID

Product ID	
DL	Chip Common Mode Choke Coils

② Structure

Code	Structure
W	Winding Type
M	Monolithic Type
P	Film Type

③ Dimensions (L×W)

Code	Dimensions (L×W)	EIA
0N	0.85×0.65mm	03025
11	1.25×1.0mm	0504
21	2.0×1.2mm	0805
31	3.2×1.6mm	1206
2A	2.0×1.0mm	0804
2H	2.5×2.0mm	1008
5A	5.0×3.6mm	2014
5B	5.0×5.0mm	2020

④ Type

Code	Type
S	Magnetically Shielded One Circuit Type
D	Magnetically Shielded Two Circuit Type
H	Open Magnetic One Circuit Type
G	Magnetically Monolithic Type (sectional winding)
T	Magnetically Shielded One Circuit Low Profile Type

⑩ Packaging

Code	Packaging	Series
K	Embossed Taping (ø330mm Reel)	DLW5AH/DLW5BS/DLW5BT
L	Embossed Taping (ø180mm Reel)	All Series
B	Bulk	All Series

⑤ Category

Code	Category
A	Expressed by a letter.
N	
R	

⑥ Impedance

Typical impedance at 100MHz is expressed by three figures. The unit is in ohm (Ω). The first and second figures are significant digits, and the third figure expresses the number of zeros which follow the two figures.

⑦ Circuit

Code	Circuit
S	Expressed by a letter.
M	
H	

⑧ Features

Code	Features
L	Expressed by a letter.
Q	
Z	

⑨ Number of Signal Lines

Code	Number of Signal Lines
2	Two Lines
3	Three Lines
4	Four Lines

3

On-Board Type (DC) EMI Suppression Filters (EMIFIL®)



Chip Common Mode Choke Coils Film Type DLP0NS/11S/31S Series

DLP0NS Series

■ Features

1. Small size and tight dimensional tolerance
Size: 0.85x0.65x0.45mm Tolerance: +-0.05mm
2. Useful impedance line-up from 67 ohm to 120 ohm
3. DLP0NS series enables noise suppression for differential signal line without distortion in high-speed signal transmission due to its line impedance matching

■ Applications

Common mode noise suppression of high speed differential signal lines for USB 2.0, IEEE1394, LVDS

1. Note PCs
2. Cellular phones
3. Digital Still Cameras, Digital Video Cameras



3

Part Number	Common Mode Impedance (at 100MHz/20 degree C) (ohm)	Rated Current (mA)	Rated Voltage (Vdc)	Insulation Resistance (min.) (M ohm)	Withstand Voltage (Vdc)	DC Resistance (ohm)
DLP0NSN670HL2	67 ±20%	110	5	100	12.5	2.4 ±25%
DLP0NSN900HL2	90 ±20%	100	5	100	12.5	3.0 ±25%
DLP0NSN121HL2	120 ±20%	90	5	100	12.5	3.8 ±25%

Operating Temperature Range: -40°C to 85°C

■ Equivalent Circuit

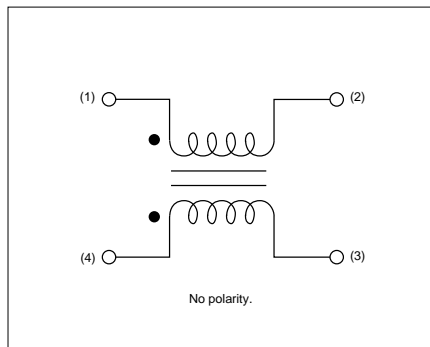

■ Impedance - Frequency

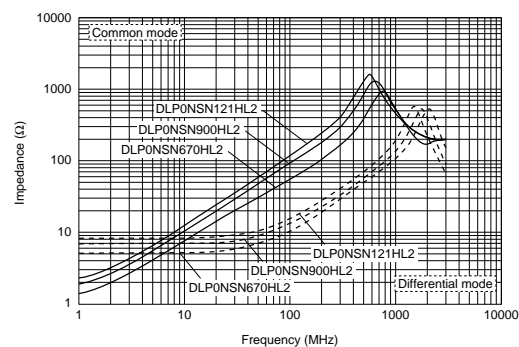

Continued on the following page. ↗

Continued from the preceding page.

Transmission Characteristics (Typical)



DLP11S Series

Features

1. Small size and tight dimensional tolerance
Size: 1.25x1.0x0.82mm Tolerance: ± 0.1 mm
2. Useful impedance line-up from 67 ohm to 330 ohm
3. DLP11S series enables noise suppression for differential signal line without distortion in high-speed signal transmission due to its high coupling
4. DLP11SN_HL2, DLP11SA series match with line impedance
5. High Cutoff Frequency is suitable for high speed differential signal line such as HDMI.
Cutoff Frequency: 6GHz (DLP11SA series)



Applications

Common mode noise suppression of high speed differential signal lines for USB, IEEE1394, LVDS

1. Note PCs, PDAs
2. Cellular phones
3. Digital Still Cameras, Digital Video Cameras

Part Number	Common Mode Impedance (at 100MHz/20 degree C) (ohm)	Rated Current (mA)	Rated Voltage (Vdc)	Insulation Resistance (min.) (M ohm)	Withstand Voltage (Vdc)	DC Resistance (ohm)
DLP11SA350HL2	35 $\pm 20\%$	170	5	100	12.5	0.9 $\pm 25\%$
DLP11SA670HL2	67 $\pm 20\%$	150	5	100	12.5	1.2 $\pm 25\%$
DLP11SN670SL2	67 $\pm 20\%$	180	5	100	12.5	1.3 $\pm 25\%$
DLP11SA900HL2	90 $\pm 20\%$	150	5	100	12.5	1.4 $\pm 25\%$
DLP11SN900HL2	90 $\pm 20\%$	150	5	100	12.5	1.5 $\pm 25\%$
DLP11SN121SL2	120 $\pm 20\%$	140	5	100	12.5	2.0 $\pm 25\%$
DLP11SN161SL2	160 $\pm 20\%$	120	5	100	12.5	2.7 $\pm 25\%$
DLP11SN201HL2	200 $\pm 20\%$	110	5	100	12.5	3.1 $\pm 25\%$
DLP11SN241HL2	240 $\pm 20\%$	100	5	100	12.5	3.5 $\pm 25\%$
DLP11SN281HL2	280 $\pm 20\%$	90	5	100	12.5	4.2 $\pm 25\%$
DLP11SN331HL2	330 $\pm 20\%$	80	5	100	12.5	4.9 $\pm 25\%$

Operating Temperature Range: -40°C to 85°C

Equivalent Circuit



Impedance - Frequency



3

Transmission Characteristics (Typical)

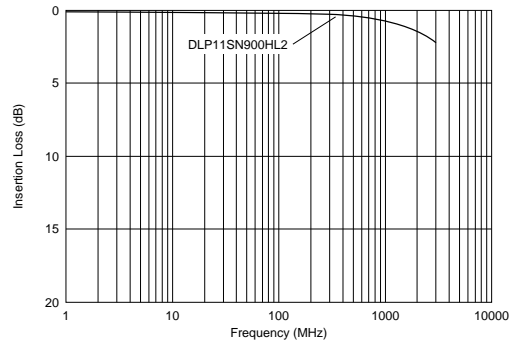
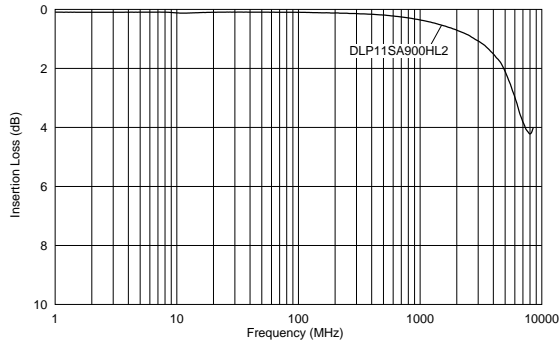

DLP31S Series

DLP31S series is chip common mode choke coil that realizes high impedance in a small size with ferrite material technology and film processing technology. DLP31S series has excellent performance at high frequency range. It is suitable for differential signal line application.

■ Features

1. Small size, low profile, SMD. 3.2x1.6x1.15mm (Tolerance: +0.15mm)
2. High common mode impedance (550 ohm at 100MHz typ.) in small size
3. DLP31S suppresses high frequency noise that was unable to be suppressed with existing common mode choke coils. Suitable for differential signal lines like USB, because DLP31S does not provide distortion to high speed signal transmission due to its high coupling (coupling coefficient: 0.98 min.)

■ Applications

1. USB lines of PCs, peripheral equipment
2. LVDS lines of Note-PCs, LCDs
3. USB lines of digital AV equipment such as digital cameras



Part Number	Common Mode Impedance (at 100MHz/20 degree C) (ohm)	Rated Current (mA)	Rated Voltage (Vdc)	Insulation Resistance (min.) (M ohm)	Withstand Voltage (Vdc)	DC Resistance (ohm)
DLP31SN121ML2	120 ±20%	100	16	100	40	2.0 max.
DLP31SN221ML2	220 ±20%	100	16	100	40	2.5 max.
DLP31SN551ML2	550 ±20%	100	16	100	40	3.6 max.

Operating Temperature Range: -40°C to 85°C

■ Equivalent Circuit

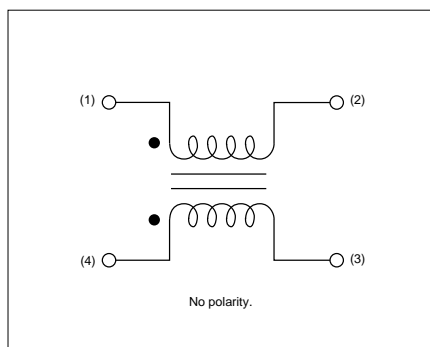

■ Impedance - Frequency

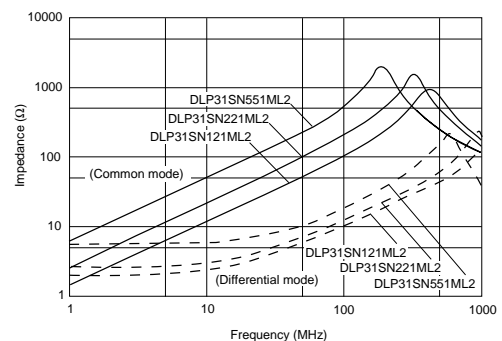

On-Board Type (DC) EMI Suppression Filters (EMIFIL®)



Chip Common Mode Choke Coils Arrays Film Type DLP2AD/31D Series

DLP2AD Series

■ Features

- 2 components are included in 2.0x1.0mm size
- Low profile: typ. 0.82mm
- High common mode impedance characteristics (max. 280 ohm, at 100MHz)
- DLP2AD can suppress common mode noise without damage to signal wave.
- DLP2AD match with line impedance.

■ Applications

Common mode noise suppression of high speed differential signal lines for USB, IEEE1394 LVDS, DVI, HDMI

- Main board of personal computers, Note PCs
- Printers, Scanners
- LCD monitors
- Game equipment
- PC peripheral equipment



DLP2AD Series

(in mm)

3

Part Number	Common Mode Impedance (at 100MHz/20 degree C) (ohm)	Rated Current (mA)	Rated Voltage (Vdc)	Insulation Resistance (min.) (M ohm)	Withstand Voltage (Vdc)	DC Resistance (ohm)
DLP2ADN670HL4	67 ±20%	140	5	100	12.5	1.3 ±25%
DLP2ADN900HL4	90 ±20%	130	5	100	12.5	1.7 ±25%
DLP2ADN121HL4	120 ±20%	120	5	100	12.5	2.0 ±25%
DLP2ADN161HL4	160 ±20%	100	5	100	12.5	2.5 ±25%
DLP2ADN201HL4	200 ±20%	90	5	100	12.5	3.2 ±25%
DLP2ADN241HL4	240 ±20%	80	5	100	12.5	3.8 ±25%
DLP2ADN281HL4	280 ±20%	80	5	100	12.5	4.6 ±25%

Operating Temperature Range: -40°C to 85°C

■ Equivalent Circuit

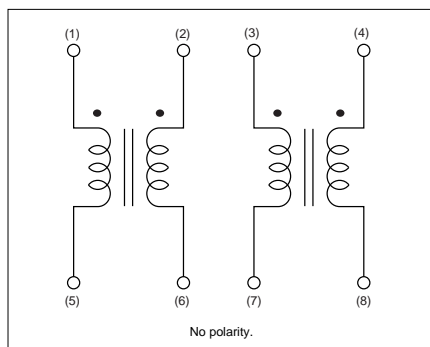

■ Impedance - Frequency



Continued on the following page. ↗

Continued from the preceding page.

Transmission Characteristics (Typical)



DLP31D Series

DLP31D series is chip common mode choke coil array which realizes high coupling and high impedance in a small size with ferrite material technology and thin film processing technology.

Features

- 2 components are included in 3.2x1.6mm
- Thin type 1.15mm
- High common mode Impedance characteristics (max. 440 ohm, at 100MHz)
- DLP31D can suppress common mode noise without damage to signal wave.

Applications

Common mode noise suppression of high speed differential signal lines for USB, IEEE1394, LVDS

- Main board of personal computers, note PCs
- Printers, Scanners
- LCD monitors
- Game equipment
- PC peripheral equipment

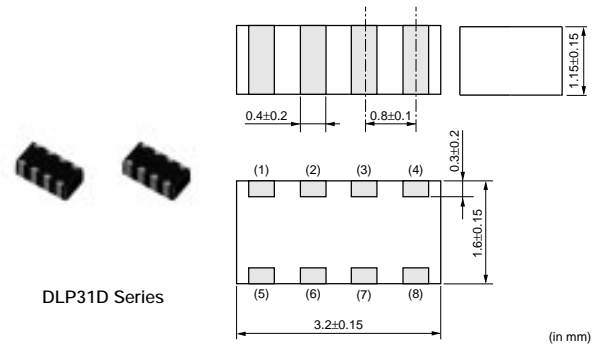

3

Part Number	Common Mode Impedance (at 100MHz/20 degree C) (ohm)	Rated Current (mA)	Rated Voltage (Vdc)	Insulation Resistance (min.) (M ohm)	Withstand Voltage (Vdc)	DC Resistance (ohm)
DLP31DN900ML4	90 ±20%	160	10	100	25	1.1 max.
DLP31DN131ML4	130 ±20%	120	10	100	25	1.6 max.
DLP31DN201ML4	200 ±20%	100	10	100	25	2.2 max.
DLP31DN321ML4	320 ±20%	80	10	100	25	3.5 max.
DLP31DN441ML4	440 ±20%	70	10	100	25	4.3 max.

Operating Temperature Range: -40°C to 85°C

■ Equivalent Circuit



■ Impedance - Frequency



On-Board Type (DC) EMI Suppression Filters (EMIFIL®)



Chip Common Mode Choke Coils Monolithic Type DLM11G/2HG Series

DLM11G Series

Small size chip common mode choke coil.
 Suitable for noise suppression at audio line for mobile phone.

■ Features

1. Small size: 1.25x1.0x0.5mm
2. Noise suppression for personal mobile equipment
3. Enables suppression of both differential mode and common mode noise.
 Common mode impedance:
 600 ohm at 100MHz (typ.)
 Differential mode impedance:
 1200 ohm at 100MHz (typ.)
4. Available for high density mounting (Narrow pitch)

■ Applications

1. Audio line for mobile phones
 (Microphones, Speakers, Headphones)
2. Handsets
3. Personal mobile equipment
 (PDAs, Digital still cameras, MD players)



3

Part Number	Common Mode Impedance (at 100MHz/20 degree C) (ohm)	Rated Current (mA)	Rated Voltage (Vdc)	Insulation Resistance (min.) (M ohm)	Withstand Voltage (Vdc)	DC Resistance (ohm)
DLM11GN601SZ2	600 ±25%	100	5	100	25	0.8 max.

Operating Temperature Range: -40°C to 85°C

■ Equivalent Circuit

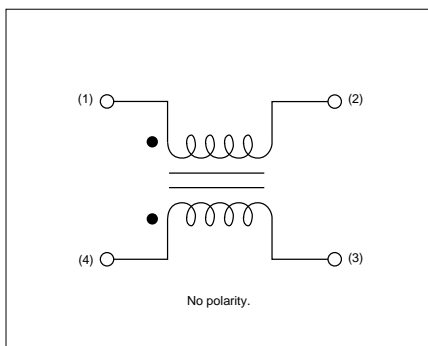

■ Impedance - Frequency



DLM2HG Series

DLM2HG Series is a high quality noise suppression filter for headphone lines of high quality digital music equipment.

■ Features

1. Low distortion in audio signal, low crosstalk
2. Effective in noise suppression both of common mode and of differential mode
3. Small size, low profile, SMD 2.5x2.0x1.2mm

■ Applications

1. Headphone lines of digital music equipment such as DVDs, MD players
2. Headphone lines of Note-PCs, PDAs

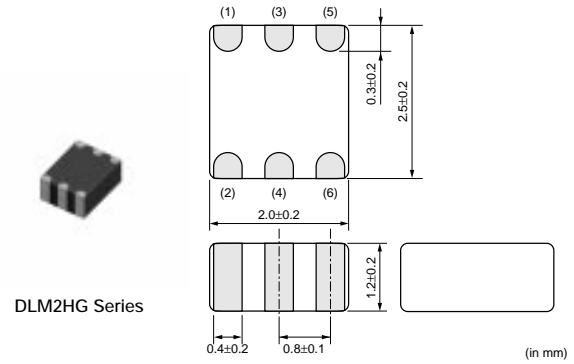

DLM2HG Series

Part Number	Common Mode Impedance (at 100MHz/20 degree C) (ohm)	Rated Current (mA)	Rated Voltage (Vdc)	Insulation Resistance (min.) (M ohm)	Withstand Voltage (Vdc)	DC Resistance (ohm)
DLM2HGN601SZ3	600 ±25%	100	16	100	100	0.40 max.

Operating Temperature Range: -40°C to 85°C

3

■ Equivalent Circuit

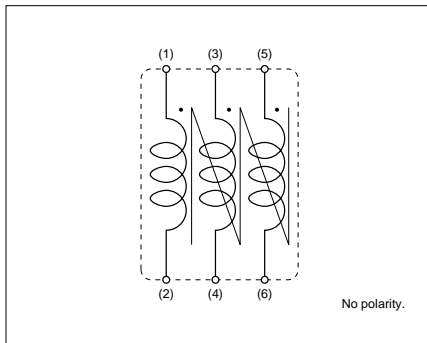

■ Impedance - Frequency

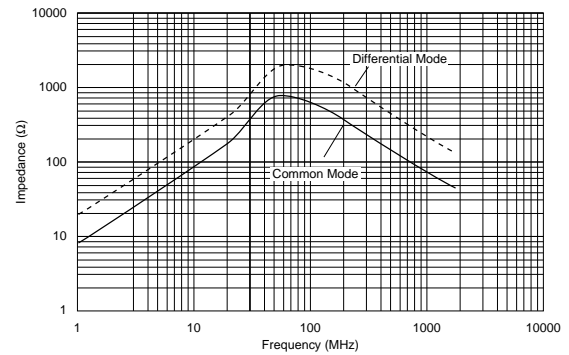

On-Board Type (DC) EMI Suppression Filters (EMIFIL®)



Chip Common Mode Choke Coils Wire Wound Type DLW21S/21H/31S Series

DLW21S Series

■ Features (DLW21S_SQ Series)

- DLW21S series realizes small size and low profile.
2.0x1.2x1.2mm
- High common mode impedance at high frequency effects excellent noise suppression performance.
- Various common mode impedance items of 67 to 370 ohm can be used, considering noise level and signal frequency.
- DLW21S series enables noise suppression for differential signal line without distortion in high speed signal transmission due to its high coupling.
- Small dimension enables higher density packaging.

DLW21S_SQ Series



■ Applications

- USB lines of PC, Peripheral equipment
- LVDS lines of Note-PCs, LCDs
- USB lines of Small digital AV equipment such as digital cameras

■ Features (DLW21S_HQ Series)

- Small size: 2.0x1.2x1.2mm
- Common mode impedance items of 67, 90 and 120 ohm, and they can be used for various differential signal lines, DLW21SN_HQ series matches line impedance of 100 ohm line.
- DLW21SN(R)_HQ series can suppress noise for the high-speed differential signal lines which are used in digital AV interfaces, such as HDMI and DVI, without damage to the signal wave.
- In case of using electrostatic protection device with DLW21SR_HQ series match with line impedance of 100 ohm line.

DLW21S_HQ Series

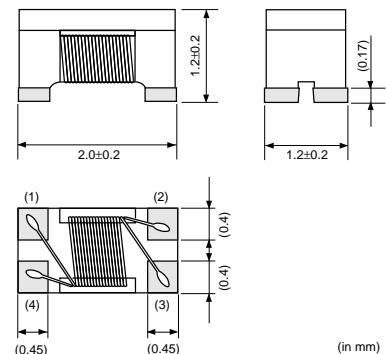

■ Applications

Common mode noise suppression of high speed differential signal lines for HDMI, DVI, USB2.0, IEEE1394, LVDS.

- DVD Recorders
- LCD TVs, LCD monitors
- PCs

DLW21SR_HQ Series is suitable for receiver side of HDMI interface line.

Part Number	Common Mode Impedance (at 100MHz/20 degree C) (ohm)	Rated Current (mA)	Rated Voltage (Vdc)	Insulation Resistance (min.) (M ohm)	Withstand Voltage (Vdc)	DC Resistance (ohm)
DLW21SN670SQ2	67 ±25%	400	50	10	125	0.25 max.
DLW21SN900SQ2	90 ±25%	330	50	10	125	0.35 max.
DLW21SN121SQ2	120 ±25%	370	50	10	125	0.30 max.

Continued on the following page.

Continued from the preceding page.

Part Number	Common Mode Impedance (at 100MHz/20 degree C) (ohm)	Rated Current (mA)	Rated Voltage (Vdc)	Insulation Resistance (min.) (M ohm)	Withstand Voltage (Vdc)	DC Resistance (ohm)
DLW21SN181SQ2	180 ±25%	330	50	10	125	0.35 max.
DLW21SN261SQ2	260 ±25%	300	50	10	125	0.40 max.
DLW21SN371SQ2	370 ±25%	280	50	10	125	0.45 max.
DLW21SN670HQ2	67 ±25%	320	20	10	50	0.31 max.
DLW21SN900HQ2	90 ±25%	280	20	10	50	0.41 max.
DLW21SN121HQ2	120 ±25%	280	20	10	50	0.41 max.
DLW21SR670HQ2	67 ±25%	400	20	10	50	0.25 max.

Operating Temperature Range: -40°C to 85°C

Equivalent Circuit



3

Impedance - Frequency

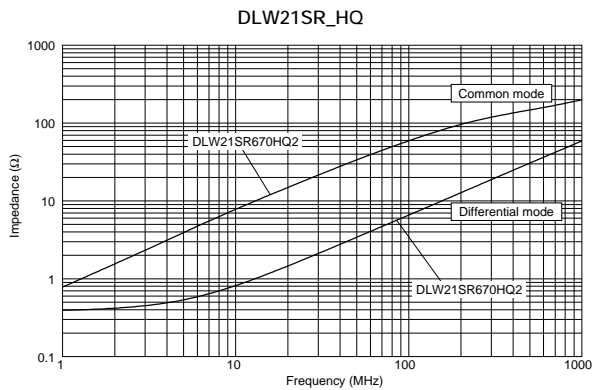
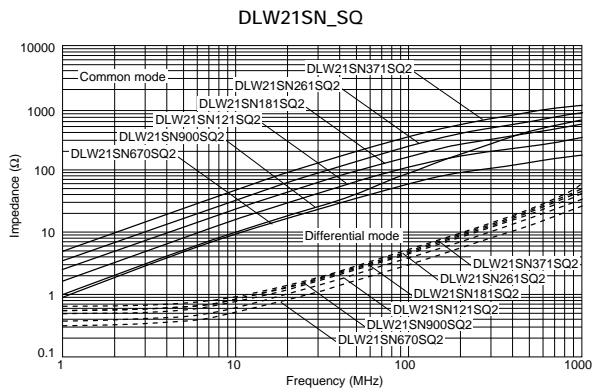

Transmission Characteristics (Typical)



DLW21H Series

■ Features

1. Small size and low profile (2.0x1.2x0.9mm).
Excellent noise suppression for sets of small and thin size.
2. High common mode impedance at high frequency effects excellent noise suppression performance.
3. Various common mode impedance from 67 to 180 ohm can be used, selected depending on noise level and signal frequency.
4. Suitable for differential signal line like USB2.0, IEEE1394 and LVDS, because DLW21H does not provide distortion to high speed signal transmission due to its high coupling. (USB2.0: DLW21HN900SQ2)
5. Small dimension enables higher density mounting

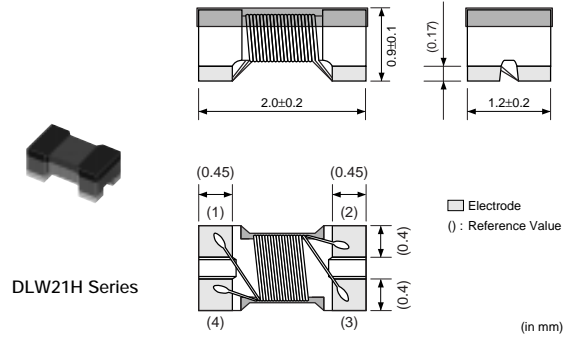

■ Applications

Common mode noise suppression of signal lines in high speed and high density digital equipment such as PCs and peripherals and telecommunications equipment.

Part Number	Common Mode Impedance (at 100MHz/20 degree C) (ohm)	Rated Current (mA)	Rated Voltage (Vdc)	Insulation Resistance (min.) (M ohm)	Withstand Voltage (Vdc)	DC Resistance (ohm)
DLW21HN670SQ2	67 ±25%	330	50	10	125	0.35 max.
DLW21HN900SQ2	90 ±25%	330	50	10	125	0.35 max.
DLW21HN121SQ2	120 ±25%	280	50	10	125	0.45 max.
DLW21HN181SQ2	180 ±25%	250	50	10	125	0.50 max.

Operating Temperature Range: -40°C to 85°C

■ Equivalent Circuit

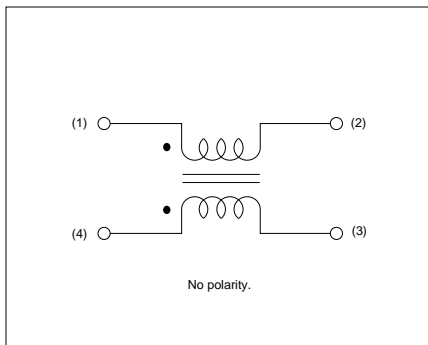

■ Impedance - Frequency

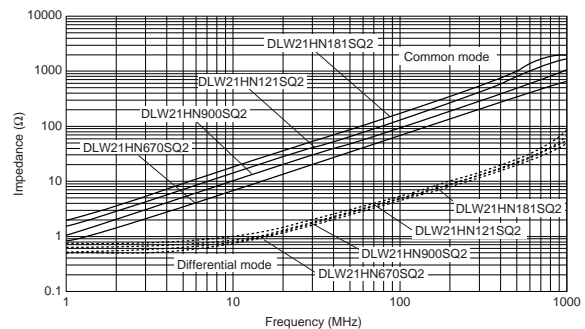

DLW31S Series

■ Features

- DLW31S realizes small size and low profile.
3.2x1.6x1.9mm.
- High common mode impedance at high frequency effects excellent noise suppression performance.
- Various common mode impedance items of 90 to 2200 ohm can be used, considering noise level and signal frequency.
- DLW31S series enables noise suppression for differential signal lines without distortion in high speed signal transmission due to its high coupling.
- Small dimension enables higher density packaging.



DLW31S Series

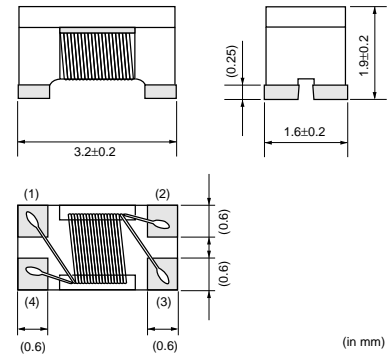

(in mm)

■ Applications

- USB lines of PCs, Peripheral equipment
- LVDS lines of Note-PCs, LCDs

3

Part Number	Common Mode Impedance (at 100MHz/20 degree C) (ohm)	Rated Current (mA)	Rated Voltage (Vdc)	Insulation Resistance (min.) (M ohm)	Withstand Voltage (Vdc)	DC Resistance (ohm)
DLW31SN900SQ2	90 ±25%	370	50	10	125	0.3 max.
DLW31SN161SQ2	160 ±25%	340	50	10	125	0.4 max.
DLW31SN261SQ2	260 ±25%	310	50	10	125	0.5 max.
DLW31SN601SQ2	600 ±25%	260	50	10	125	0.8 max.
DLW31SN102SQ2	1000 ±25%	230	50	10	125	1.0 max.
DLW31SN222SQ2	2200 ±25%	200	50	10	125	1.2 max.

Operating Temperature Range: -40°C to 85°C

■ Equivalent Circuit

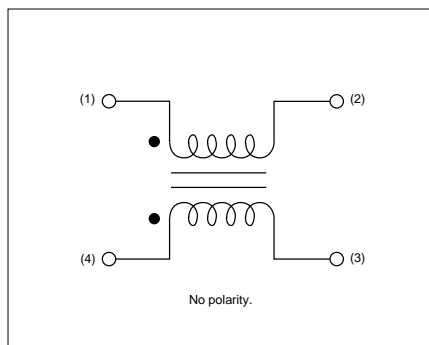

■ Impedance - Frequency

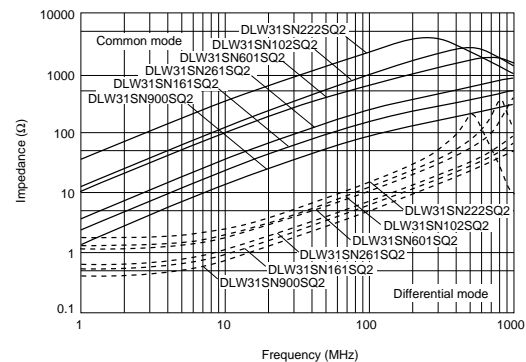

On-Board Type (DC) EMI Suppression Filters (EMIFIL®)



Chip Common Mode Choke Coils Wire Wound Type for Large Current DLW5AH/5BS/5BT Series

DLW5AH/5BS Series

DLW5AH/5BS series is a high performance wound type chip common mode choke coil.

■ Features

1. High impedance (max. of 4000ohm at 100MHz: DLW5AH) enables great noise suppression.
2. Large rated current (max. of 5A) is suitable for power line use.
3. DLW5AH/BS series does not damage high speed signal due to high coupling common mode choke coil structure.
4. Automatic mounting can be applied.

■ Applications

1. DC power lines in AC adapters of Portable equipment
2. DC power lines of DC-DC converters, battery chargers

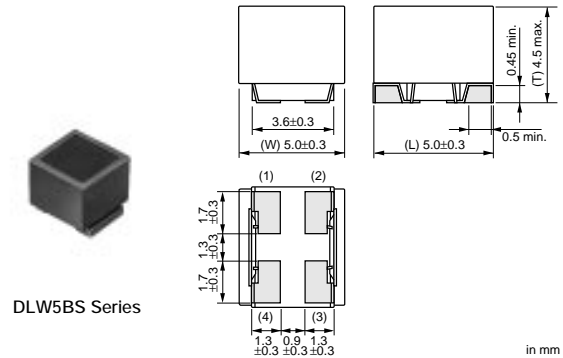
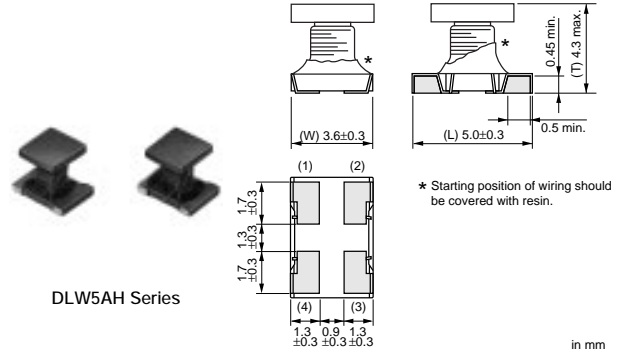

Part Number	Common Mode Impedance (at 100MHz/20 degree C) (ohm)	Rated Current (mA)	Rated Voltage (Vdc)	Insulation Resistance (min.) (M ohm)	Withstand Voltage (Vdc)	DC Resistance (ohm)
DLW5AHN402SQ2	4000 (Typ.)	200	50	10	125	3.0 max.
DLW5BSN191SQ2	190 (Typ.)	5000	50	10	125	0.02 max.
DLW5BSN351SQ2	350 (Typ.)	2000	50	10	125	0.04 max.
DLW5BSN102SQ2	1000 (Typ.)	1500	50	10	125	0.06 max.
DLW5BSN152SQ2	1500 (Typ.)	1000	50	10	125	0.1 max.
DLW5BSN302SQ2	3000 (Typ.)	500	50	10	125	0.3 max.

Operating Temperature Range: -25°C to 85°C

In operating temperature exceeding +75°C, derating of current is necessary for DLW5BSN191SQ2.

Please refer to p.138, "Derating of Rated Current".

3

■ Equivalent Circuit



■ Impedance - Frequency



■ Derating of Rated Current

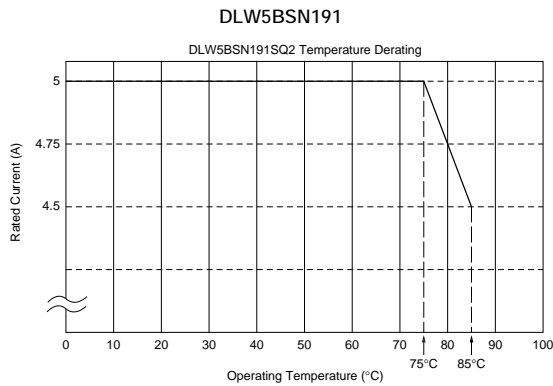

3

DLW5BT Series

Low profile (h=2.5mm) chip common mode choke coil.
 Suitable for noise suppression at DC power lines.

■ Features

1. Low profile (h=2.5mm)
2. Small size (5.0x5.0mm) and high rated current (1.5 to 6A)
3. High common mode Impedance (max. 1400 ohm, at 100MHz)

■ Applications

Noise suppression for power line

1. Power line equipment
 - DC-DC converters
 - Battery chargers
2. Portable equipment
 - PDAs (Personal Digital Assistants)
 - Note PCs
 - Printers

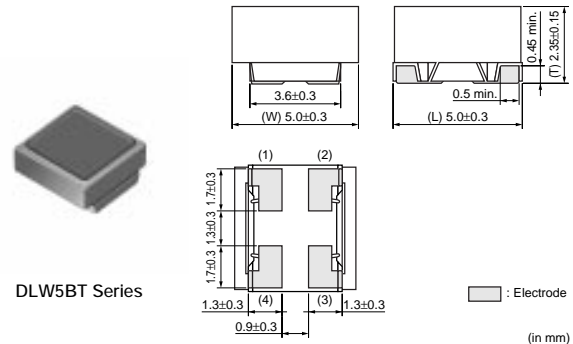

Part Number	Common Mode Impedance (at 100MHz/20 degree C) (ohm)	Rated Current (mA)	Rated Voltage (Vdc)	Insulation Resistance (min.) (M ohm)	Withstand Voltage (Vdc)	DC Resistance (ohm)
DLW5BTN101SQ2	100 (Typ.)	6000	50	10	125	0.009 ±40%
DLW5BTN251SQ2	250 (Typ.)	5000	50	10	125	0.014 ±40%
DLW5BTN501SQ2	500 (Typ.)	4000	50	10	125	0.019 ±40%
DLW5BTN102SQ2	1000 (Typ.)	2000	50	10	125	0.024 ±40%
DLW5BTN142SQ2	1400 (Typ.)	1500	50	10	125	0.040 ±40%

Operating Temperature Range: -25°C to 85°C

In operating temperature exceeding +60°C, derating of current is necessary for DLW5BTN101/251/501.

Please refer to p.139, "Derating of Rated Current".

■ Equivalent Circuit

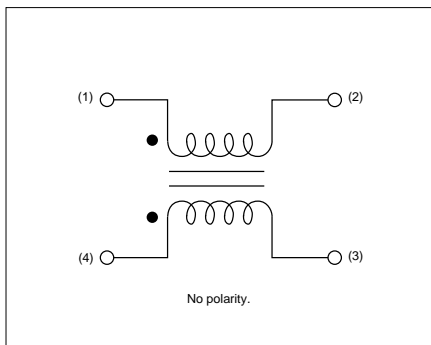

■ Impedance - Frequency



■ Derating of Rated Current

DLW5BTN101/251/501



On-Board Type (DC) EMI Suppression Filters (EMIFIL®)



Block Type EMIFIL® BNX Series

SMD Type

BNX022 series is SMD type high performance and provides excellent noise suppression on DC power lines.

■ Features

1. Large rated current (10A-15A) and Low DC Resistance. (0.43m ohm - Typ.)
2. High insertion loss characteristic over a wide frequency range of 1MHz to 1GHz.
3. Mounting area and volume is reduced.
4. Effective for impulse noise such as electro-static discharge or spike noise.

■ Applications

1. Displays (PDP/LCD-TV)
2. Digital AV equipment
3. Amusement equipment
4. PC peripheral equipment
5. Industry equipment, measurement equipment, power supplies



BNX022/023



4

Part Number	Rated Voltage (Vdc)	Withstand Voltage (Vdc)	Rated Current (A)	Insulation Resistance (min.) (M ohm)	Insertion Loss
BNX022-01	50	125	10	500	1MHz to 1GHz:35dB min. (20 to 25 degrees C line impedance=50 ohm)
BNX023-01	100	250	15	500	1MHz to 1GHz:35dB min. (20 to 25 degrees C line impedance=50 ohm)

Operating Temperature Range: -40°C to 125°C
 In operating temperatures exceeding +85°C, derating of current is necessary.
 Please refer to p.141, "Derating of Rated Current".

■ Equivalent Circuit

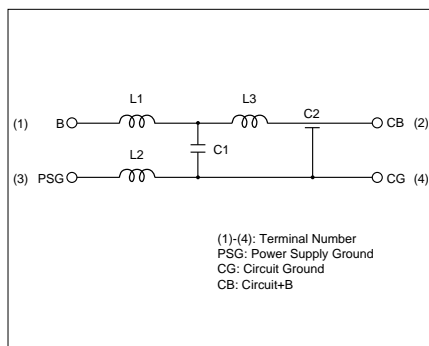

■ Insertion Loss Characteristics

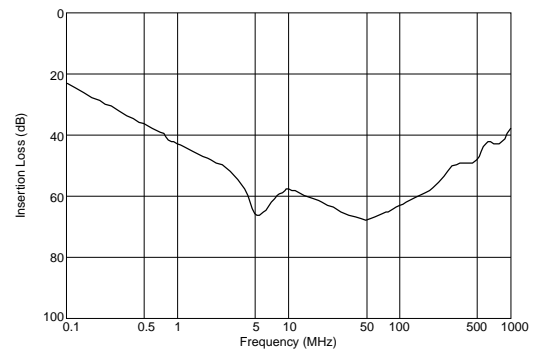

Continued on the following page. ↗

Continued from the preceding page.

Derating of Rated Current

In operating temperatures exceeding +85°C, derating of current is necessary for BNX022 series. Please apply the derating curve shown in chart according to the operating temperature.

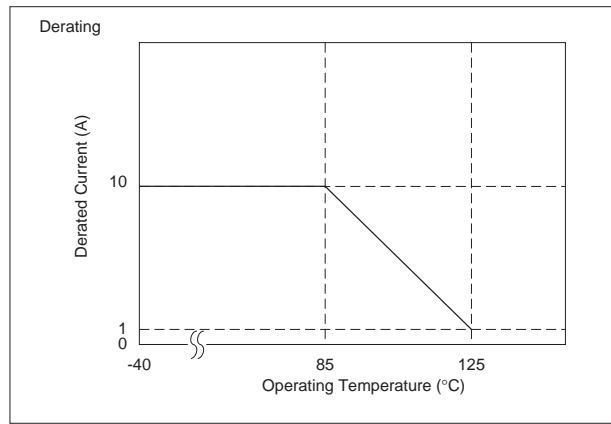

In operating temperatures exceeding +85°C, derating of current is necessary for BNX023 series. Please apply the derating curve shown in chart according to the operating temperature.

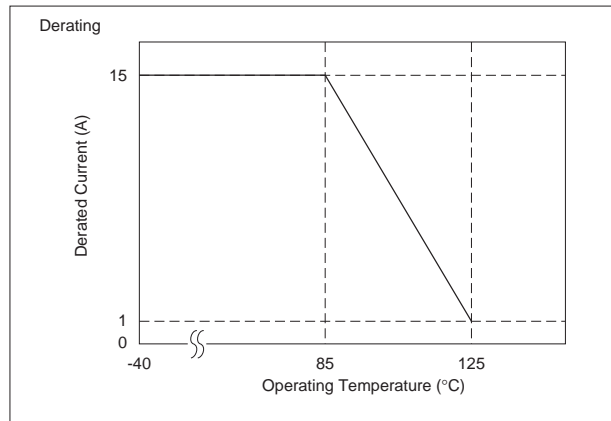

Lead Type

The block type "EMIFIL" BNX series incorporates through-type capacitor, monolithic chip capacitors and bead. The BNX is high performance for use in DC power circuits.

Features

1. The filter enables obtaining high insertion loss in wide frequency ranges from 0.5MHz to 1GHz.
2. Effective for impulse noise such as electrostatic discharge or spike noise.
3. There are no connection routes in the current circuits, thus ensuring highly reliable performance.

Applications

1. Displays (PDP/LCD-TV)
2. Digital AV equipment
3. Amusement equipment
4. PC peripheral equipment
5. Industry equipment

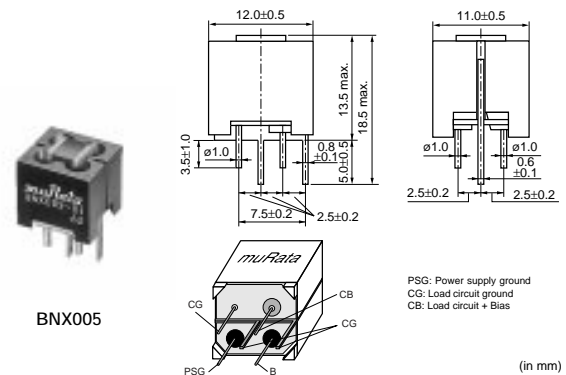
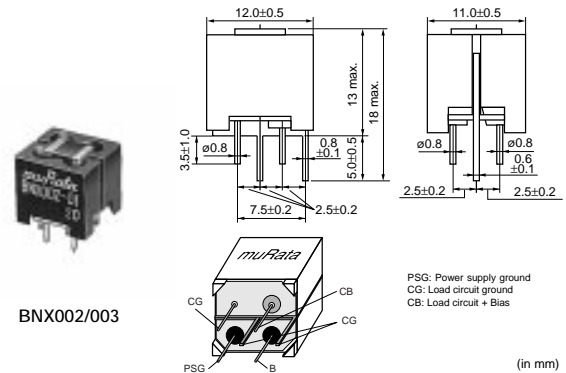

Part Number	Rated Voltage (Vdc)	Withstand Voltage (Vdc)	Rated Current (A)	Insulation Resistance (min.) (M ohm)	Insertion Loss
BNX002-01	50	125	10	100	1MHz to 1GHz:40dB min. (20 to 25 degrees C line impedance=50 ohm)
BNX003-01	150	375	10	100	5MHz to 1GHz:40dB min. (20 to 25 degrees C line impedance=50 ohm)
BNX005-01	50	125	15	100	1MHz to 1GHz:40dB min. (20 to 25 degrees C line impedance=50 ohm)

Operating Temperature Range: -30°C to 85°C

Equivalent Circuit



Insertion Loss Characteristics



Lead Type Low Profile

The block type "EMIFIL" BNX010 series is high performance and BNX series provide excellent noise suppression on DC power lines.

Features

- High insertion loss characteristic over a wide frequency band range.
 1MHz to 1GHz: 40dB min (BNX012)
 100kHz to 1GHz: 40dB min (BNX016)
- Large rated current (15A) and Low Rdc (0.8m ohm-typ.)
- Low profile (height: 8.0mm except lead terminal)
- Effective for impulse noise such as electrostatic discharge or spike noise.

Applications

- Displays (PDP/LCD-TV)
- Digital AV equipment
- Amusement equipment
- PC peripheral equipment
- Industry equipment

4

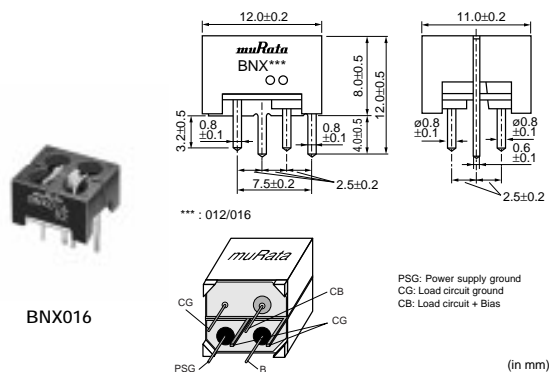
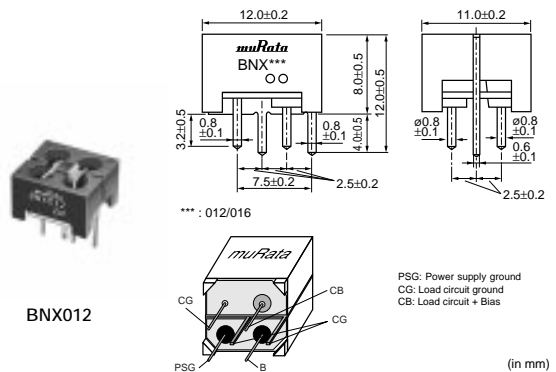

Part Number	Rated Voltage (Vdc)	Withstand Voltage (Vdc)	Rated Current (A)	Insulation Resistance (min.) (M ohm)	Insertion Loss
BNX012-01	50	125	15	500	1MHz to 1GHz:40dB min. (20 to 25 degrees C line impedance=50 ohm)
BNX016-01	25	62.5	15	50	100kHz to 1GHz:40dB min. (20 to 25 degrees C line impedance=50 ohm)

Operating Temperature Range: -40°C to 125°C

In operating temperatures exceeding +85°C, derating of current is necessary.
 Please refer to p.143, "Derating of Rated Current".

■ Equivalent Circuit

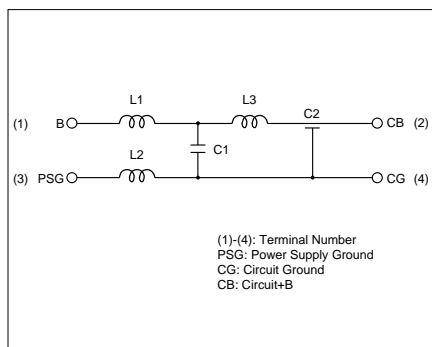

■ Insertion Loss Characteristics



■ Notice

● Rating

In operating temperatures exceeding +85°C, derating of current is necessary for BNX01□ series. Please apply the derating curve shown in chart according to the operating temperature.

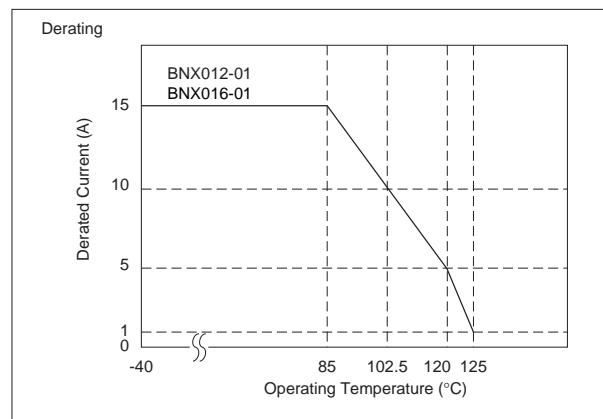

● Connecting ± power line

In case of using ± power line, please connect to each terminal as shown.

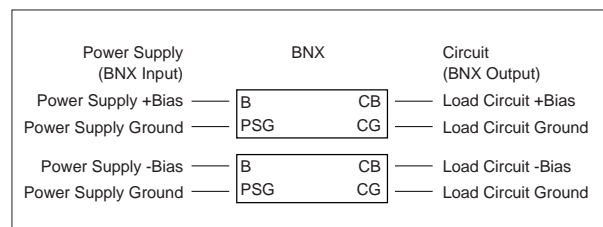

4

Noise Suppression Effect of BNX Series

■ Suppression of DC Side Ripple of the Switching Power Supply

Testing Circuit

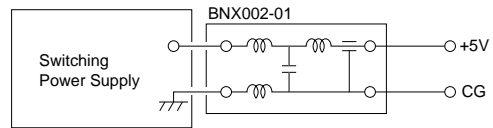

Type of Filter	EMI Suppression Effect	Description
When BNX002 is not used	<p>+5.0V → 50µs/div 0.2V/div</p>	High frequency noise, max. 0.5V, can be seen.
When BNX002 is used	<p>+5.0V → 50µs/div 0.2V/div</p>	Noise can be almost suppressed by BNX002 .

4

■ Example of Impulse Noise Suppression

Type of Filter	EMI Suppression Effect
Without filter	<p>Impulse Noise 2000V/50ns</p> <p>Y-axis: 500V/div X-axis: 10ns/sec</p>
When BNX002 is used.	<p>Y-axis: 500V/div X-axis: 10ns/sec</p>

On-Board Type (DC) EMI Suppression Filters (EMIFIL®)



Ferrite Beads Inductors Part Numbering

Ferrite Beads Inductors

(Part Number)



① Product ID

Product ID	
BL	Ferrite Beads Inductors

② Series

Code	Series
01	Beads ø3.6
02	Beads ø3.4
03	Beads ø2.3 max.

③ Beads Core Material

Code	Beads Core Material
RN	Standard Type

④ Numbers of Beads Core

Code	Numbers of Beads Core
1	1
2	2

⑤ Lead Type

Code	Lead Type	Series
A1	Axial Straight Type	BL01
A2	Axial Crimp Type	BL01
R1	Radial Straight Type	BL02/BL03
R2	Radial Straight and Wave Formed Leads Type	BL02
R3	Radial Incrimp Type	BL02

⑥ Lead Length, Space

Code	Lead Length, Space	Series
A	Bulk, Axial Type, 3.7mm	BL01
D	Bulk, Axial Type, 45.0mm	
E	Taping Axial Type, 26.0mm	
F	Taping, Axial Type, 52.0mm	BL02/BL03
J	Bulk, Radial Type, 5.0mm	
M	Bulk, Radial Type, 10.0mm	
N	Taping, Radial Type, 16.5mm	
P	Taping, Radial Type, 18.5mm	
Q	Taping, Radial Type, 20.0mm	

⑦ Lead Diameter

Code	Lead Diameter
1	ø0.60mm
2	ø0.65mm

⑧ Packaging

Code	Packaging	Series
A	Ammo Pack	BL01/BL02/BL03
B	Bulk	All Series
J	Paper Reel (ø320mm)	BL01

On-Board Type (DC) EMI Suppression Filters (EMIFIL®)



Ferrite Beads Inductors BL01/02/03 Series

BL01/BL02/BL03 Series

■ Features

BL01/02/03 series are ferrite beads with lead wires to produce a high frequency loss for suppression of noise. Simple construction and easy-to-use, effective for low impedance circuits such as power supplies and grounds. Effective also for preventing overshoot and undershoot of digital signal in clocks or the like, and suppressing the higher harmonic wave. Suitable for prevention of abnormal oscillation at high frequency amplifying circuit.

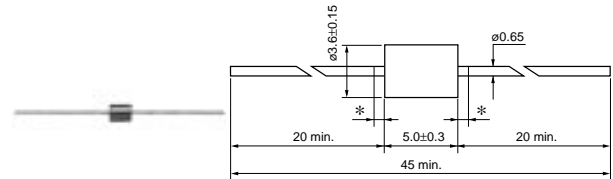

BL01RN1A1D2B

*Coating extending on leads : 1.5 max.

(in mm)

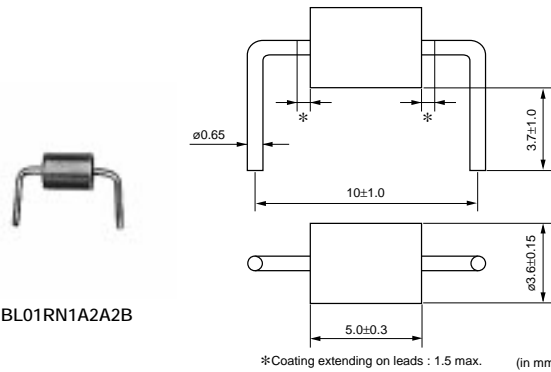

BL01RN1A2A2B

*Coating extending on leads : 1.5 max. (in mm)

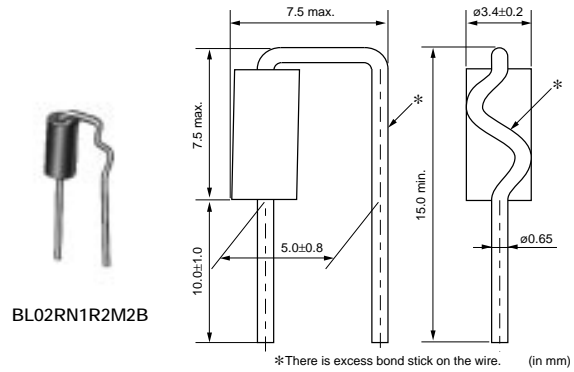

BL02RN1R2M2B

*There is excess bond stick on the wire. (in mm)

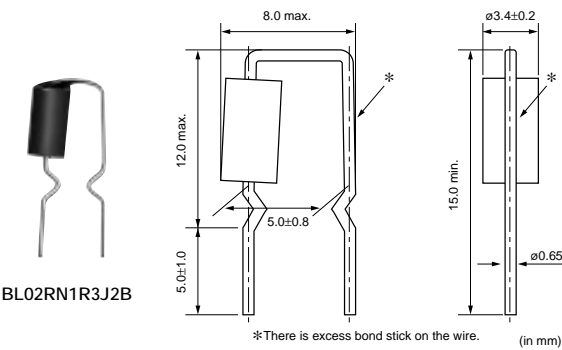

BL02RN1R3J2B

*There is excess bond stick on the wire. (in mm)

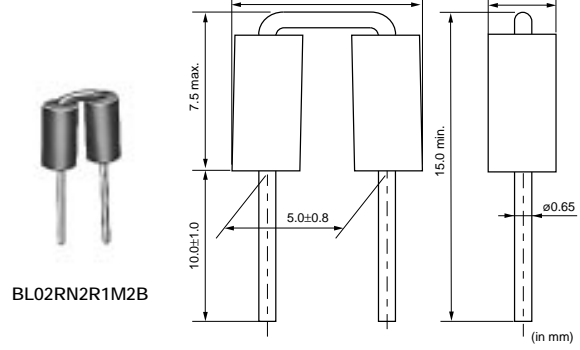

BL02RN2R1M2B

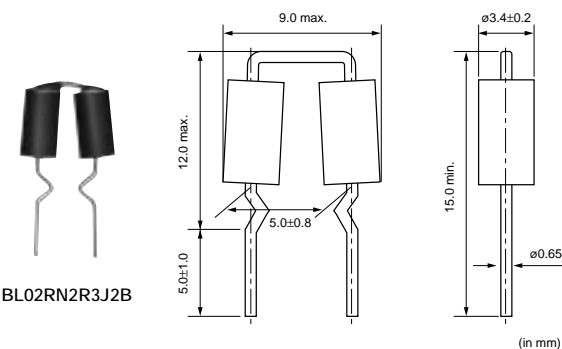

BL02RN2R3J2B

(in mm)

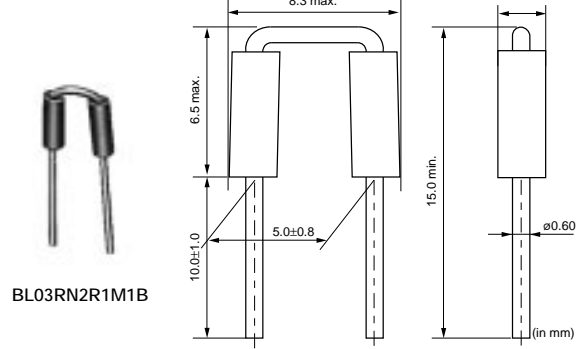

BL03RN2R1M1B

(in mm)

Part Number	Rated Current (A)	Operating Temperature Range (°C)
BL01RN1A1D2B	7	-40 to +85
BL01RN1A1E1A	6	-40 to +85
BL01RN1A1F1J	6	-40 to +85
BL01RN1A2A2B	7	-40 to +85
BL02RN1R2M2B	7	-40 to +85
BL02RN1R2N1A	6	-40 to +85
BL02RN1R2P1A	6	-40 to +85
BL02RN1R2Q1A	6	-40 to +85
BL02RN1R3J2B	7	-40 to +85
BL02RN1R3N1A	6	-40 to +85
BL02RN2R1M2B	7	-40 to +85
BL02RN2R1N1A	6	-40 to +85
BL02RN2R1P1A	6	-40 to +85
BL02RN2R1Q1A	6	-40 to +85
BL02RN2R3J2B	7	-40 to +85
BL02RN2R3N1A	6	-40 to +85
BL03RN2R1M1B	6	-40 to +85
BL03RN2R1N1A	6	-40 to +85
BL03RN2R1P1A	6	-40 to +85
BL03RN2R1Q1A	6	-40 to +85

Please refer to p.193, "Ferrite Beads Inductors Packaging" for Dimensions of Part Numbers except 'B' for the last code.

■ Equivalent Circuit



5

■ Impedance - Frequency Characteristics



Continued on the following page. ↗

Continued from the preceding page.

■ Impedance - Frequency Characteristics

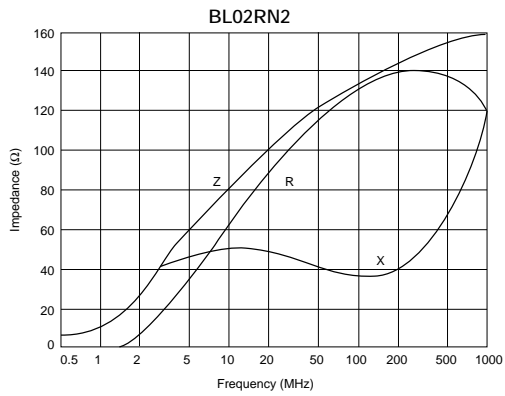

On-Board Type (DC) EMI Suppression Filters (EMIFIL®)



Disc Type EMIFIL® Part Numbering

Disc Type EMIFIL®

(Part Number)

DS	S	9	H	B3	2E	271	Q55	B
①	②	③	④	⑤	⑥	⑦	⑧	⑨

① Product ID

Product ID	
DS	Three-terminals Capacitor

② Structure

Code	Structure
N	No Ferrite Beads Type
S	Built-in Ferrite Beads Type
T	with Ferrite Beads Type

③ Style

Code	Style
6	Diameter 8.0mm max.
9	Diameter 12.0mm max.

④ Category

Code	Category
N	for General Use
H	for Heavy-duty

⑤ Temperature Characteristics

Code	Capacitance Change
B3/P3	±10% (Temperature Range: -25°C to +85°C)
C5	±22% (Temperature Range: -25°C to +85°C)
T3	+20/-30% (Temperature Range: -25°C to +85°C)
E5	+22/-56% (Temperature Range: -25°C to +85°C)
F3	+30/-80% (Temperature Range: -25°C to +85°C)
Z8	+30/-85% (Temperature Range: -10°C to +60°C)

⑥ Rated Voltage

Code	Rated Voltage
1C	16V
1H	50V
2A	100V
2E	250V

⑦ Capacitance

Expressed by three figures. The unit is in pico-farad (pF). The first and second figures are significant digits, and the third figure expresses the number of zeros which follow the two figures.

⑧ Lead Type/⑨ Packaging

Code	Lead Type	Lead Length* (in mm)	Packaging	Series
Q55B	Straight	25.0 min.	Bulk	All series
Q50B		4.0±0.5		DST9N/H
Q52B		6.0±1.0		DST9N
Q54B		4.0±0.5		DSN6N/9N, DSS6N/9N, DSS9H
Q56B		6.0±1.0		DSS6N
T41B	Incrimp	4.0±0.5	Paper Reel (ø320mm)	DSS9N/H
T51B		25.0 min.		DS□6N, DSN9N/H
Q91J	Straight	20.0±1.0	Ammo Pack	All series except DSS9N/H
Q92J		16.5±1.0		DSS6N
Q93J		18.5±1.0		
Q91A		20.0±1.0		
Q92A		16.5±1.0		
Q93A	18.5±1.0			
U21A	Incrimp	16.5±1.0		
U31A		18.5±1.0		

*Lead Distance between Reference and Bottom Planes except Bulk.

On-Board Type (DC) EMI Suppression Filters (EMIFIL®)



Disc Type EMIFIL® DSN6/DSS6 Series

■ Features

DS_6 is a compact, high performance lead type EMI suppression filter which can be mounted 2.54mm pitch. Its three terminal structure enables precise high frequency performance.

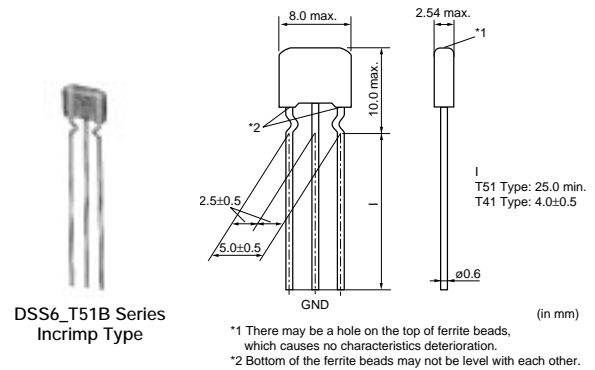
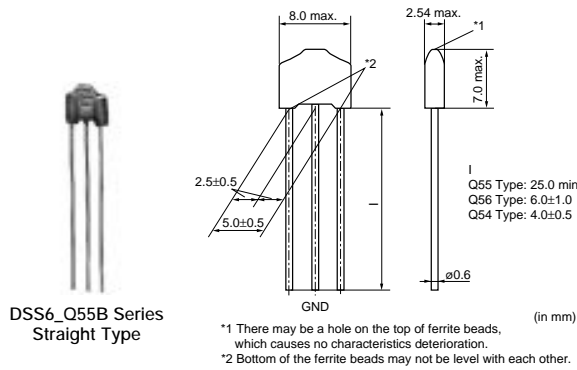
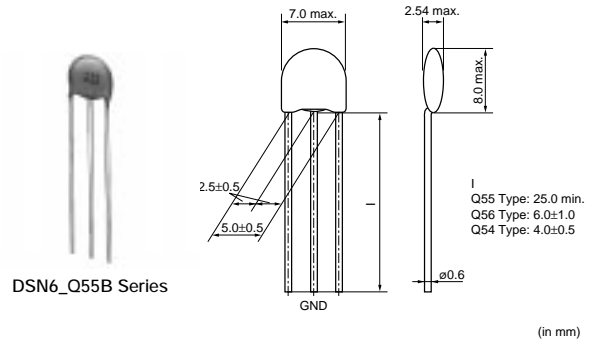

DSN6 Series

Part Number	Capacitance (pF)	Rated Voltage (Vdc)	Rated Current (A)	Operating Temperature Range (°C)
DSN6NC51H220	22 +20%, -20%	50	6	-25 to +85
DSN6NC51H330	33 +20%, -20%	50	6	-25 to +85
DSN6NC51H470	47 +20%, -20%	50	6	-25 to +85
DSN6NC51H101	100 +20%, -20%	50	6	-25 to +85
DSN6NC51H271	270 +20%, -20%	50	6	-25 to +85
DSN6NC51H102	1000 +20%, -20%	50	6	-25 to +85
DSN6NC51H222	2200 +20%, -20%	50	6	-25 to +85
DSN6NZ81H103	10000 +80%, -20%	50	6	-25 to +85

Please refer to Part Numbering for Type and Length of Lead.

■ Equivalent Circuit



■ Insertion Loss Characteristics

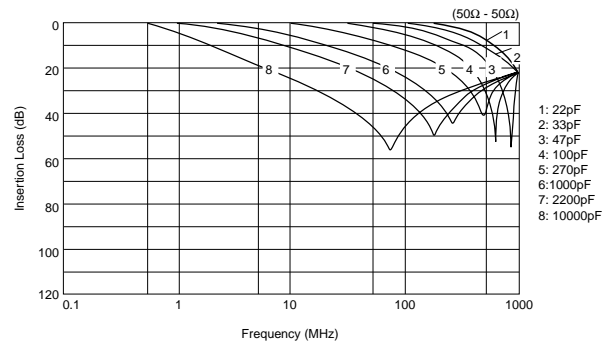

Built-in Ferrite Beads DSS6 Series Straight Type

Part Number	Capacitance (pF)	Rated Voltage (Vdc)	Rated Current (A)	Operating Temperature Range (°C)
DSS6NC52A220	22 +20%, -20%	100	6	-25 to +85
DSS6NC52A330	33 +20%, -20%	100	6	-25 to +85
DSS6NC52A470	47 +20%, -20%	100	6	-25 to +85
DSS6NC52A101	100 +20%, -20%	100	6	-25 to +85
DSS6NC52A151	150 +20%, -20%	100	6	-25 to +85
DSS6NC52A221	220 +20%, -20%	100	6	-25 to +85
DSS6NC52A271	270 +20%, -20%	100	6	-25 to +85
DSS6NC52A471	470 +20%, -20%	100	6	-25 to +85
DSS6NC52A102	1000 +20%, -20%	100	6	-25 to +85
DSS6NE52A222	2200 +80%, -20%	100	6	-25 to +85
DSS6NZ82A103	10000 +30%, -30%	100	6	-25 to +85
DSS6NF31C223	22000 +80%, -20%	16	6	-25 to +85

Please refer to Part Numbering for Type and Length of Lead.

■ Equivalent Circuit



■ Insertion Loss Characteristics

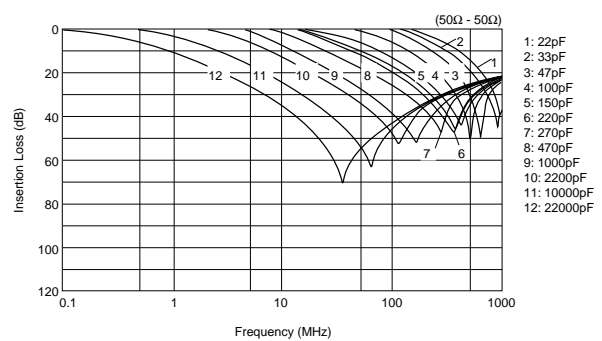

5

Built-in Ferrite Beads DSS6 Series Incrimp Type

Part Number	Capacitance (pF)	Rated Voltage (Vdc)	Rated Current (A)	Operating Temperature Range (°C)
DSS6NC52A220	22 +20%, -20%	100	6	-25 to +85
DSS6NC52A330	33 +20%, -20%	100	6	-25 to +85
DSS6NC52A470	47 +20%, -20%	100	6	-25 to +85
DSS6NC52A101	100 +20%, -20%	100	6	-25 to +85
DSS6NC52A151	150 +20%, -20%	100	6	-25 to +85
DSS6NC52A221	220 +20%, -20%	100	6	-25 to +85
DSS6NC52A271	270 +20%, -20%	100	6	-25 to +85
DSS6NC52A471	470 +20%, -20%	100	6	-25 to +85
DSS6NC52A102	1000 +20%, -20%	100	6	-25 to +85
DSS6NE52A222	2200 +80%, -20%	100	6	-25 to +85
DSS6NZ82A103	10000 +30%, -30%	100	6	-25 to +85
DSS6NF31C223	22000 +80%, -20%	16	6	-25 to +85

Please refer to Part Numbering for Type and Length of Lead.

■ Equivalent Circuit

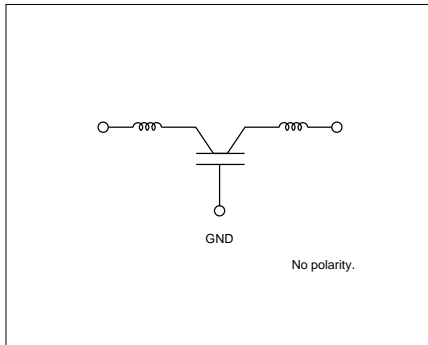

■ Insertion Loss Characteristics

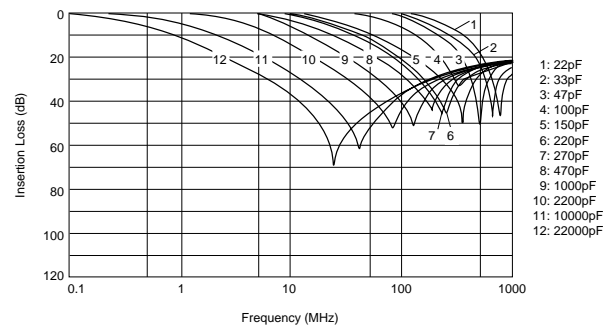

On-Board Type (DC) EMI Suppression Filters (EMIFIL®)



Disc Type EMIFIL® Broad Type DSN9/DSS9/DST9 Series

■ Features

DS_9 is a basic type EMI suppression filter which can obtain high insertion loss in a wide frequency range. Its three terminal structure enables precise high frequency performance. DSS9NP32A222/DSS9NT31H223 are low distortion types for audio circuits.

■ Supplement

Diameter of lead is 0.6mm for taping type.
Taping type is three terminal in-line arrangement.

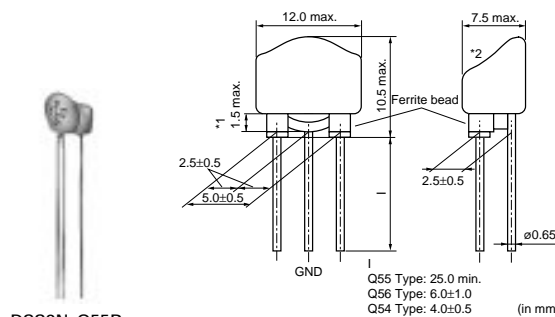
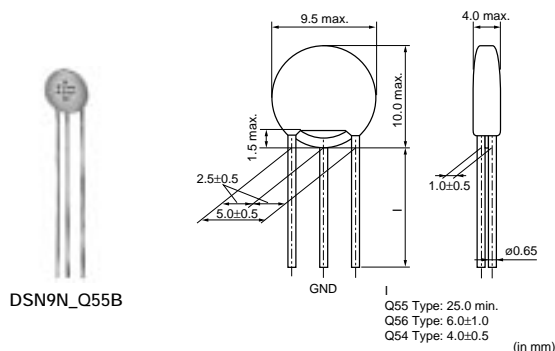

*1 Coating extending on leads does not exceed the tangent line. Exposed electrode, if any, is covered by solder, etc.
 *2 There should not be the exposure of the ferrite bead if a hole is in top of filter, the ferrite bead should not be exposed.

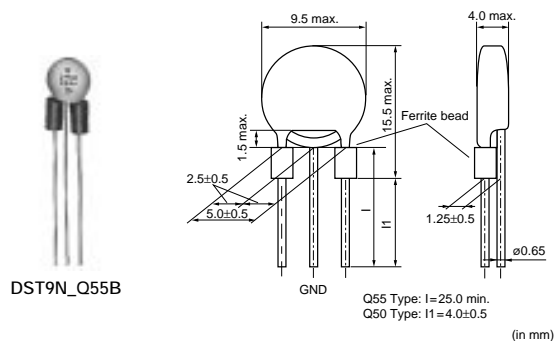

DSN9 Series

Part Number	Capacitance (pF)	Rated Voltage (Vdc)	Rated Current (A)	Operating Temperature Range (°C)
DSN9NC52A271	270 +20%,-20%	100	7	-25 to +85
DSN9NC52A222	2200 +20%,-20%	100	7	-25 to +85
DSN9NC51H223	22000 +50%,-20%	50	7	-25 to +85
DSN9NC51C104	100000 +20%,-20%	16	7	-25 to +85

Rated current is 6A for taping type and its lead diameter is phi 0.6mm.
Please refer to Part Numbering for Type and Length of Lead.

Equivalent Circuit



Insertion Loss Characteristics

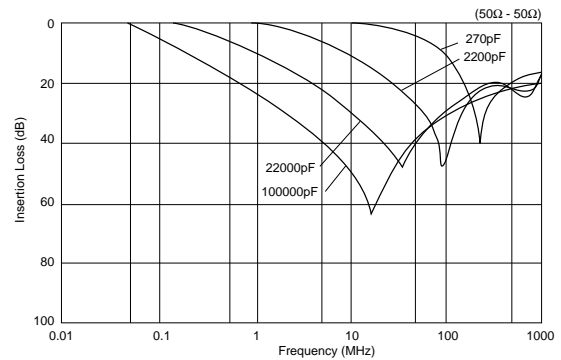

Built-in Ferrite Beads DSS9 Series

Part Number	Capacitance (pF)	Rated Voltage (Vdc)	Rated Current (A)	Operating Temperature Range (°C)
DSS9NC52A220	22 +20%,-20%	100	7	-25 to +85
DSS9NC52A470	47 +20%,-20%	100	7	-25 to +85
DSS9NC52A101	100 +20%,-20%	100	7	-25 to +85
DSS9NC52A271	270 +20%,-20%	100	7	-25 to +85
DSS9NC52A222	2200 +20%,-20%	100	7	-25 to +85
DSS9NP32A222	2200 +20%,-20%	100	7	-25 to +85
DSS9NC51H223	22000 +50%,-20%	50	7	-25 to +85
DSS9NT31H223	22000 +50%,-20%	50	7	-25 to +85

Rated current is 6A for taping type and its lead diameter is phi 0.6mm.
DSS9NP32A222/DSS9NT31H223 are low distortion types for audio IF circuits.
Please refer to Part Numbering for Type and Length of Lead.

5

Equivalent Circuit



Insertion Loss Characteristics



With Ferrite Beads DST9 Series

Part Number	Capacitance (pF)	Rated Voltage (Vdc)	Rated Current (A)	Operating Temperature Range (°C)
DST9NC52A271	270 +20%,-20%	100	7	-25 to +85
DST9NC52A222	2200 +20%,-20%	100	7	-25 to +85
DST9NC51H223	22000 +50%,-20%	50	7	-25 to +85

Rated current is 6A for taping type and its lead diameter is phi 0.6mm.
 Please refer to Part Numbering for Type and Length of Lead.

■ Equivalent Circuit

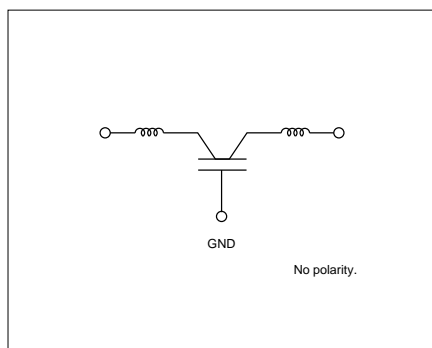

■ Insertion Loss Characteristics

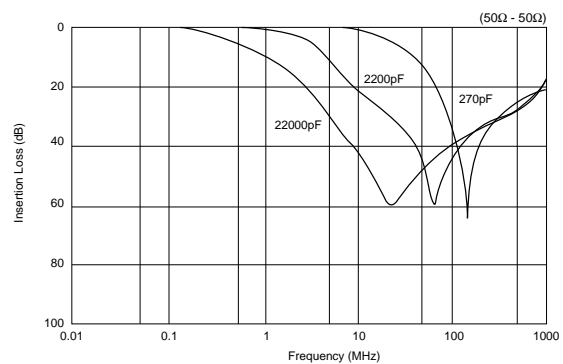

On-Board Type (DC) EMI Suppression Filters (EMIFIL®)



Disc Type EMIFIL® Heavy-duty Type DSN9H/DSS9H/DST9H Series

■ Features

DS_9H is a basic type EMI suppression filter which can obtain high insertion loss in a wide frequency range. Its three terminal structure enables nice high frequency performance. High rated voltage of 250Vdc and wide operating temperature range from -40 degrees C to 105 degrees C are suitable for high reliability circuits.

■ Supplement

Diameter of lead is 0.6mm for taping type.
Taping type is three terminal in-line arrangement.

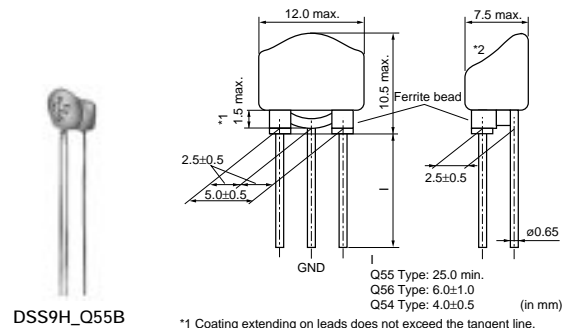
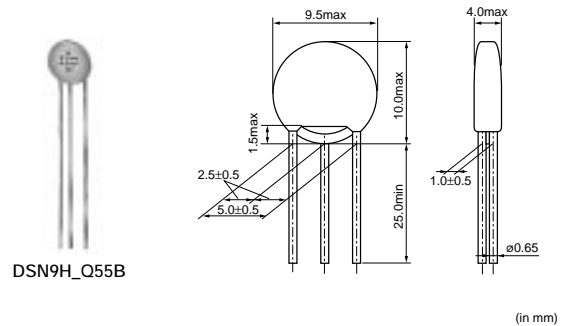

*1 Coating extending on leads does not exceed the tangent line. Exposed electrode, if any, is covered by solder, etc.
 *2 There should not be the exposure of the ferrite bead if a hole is in top of filter, the ferrite bead should not be exposed.

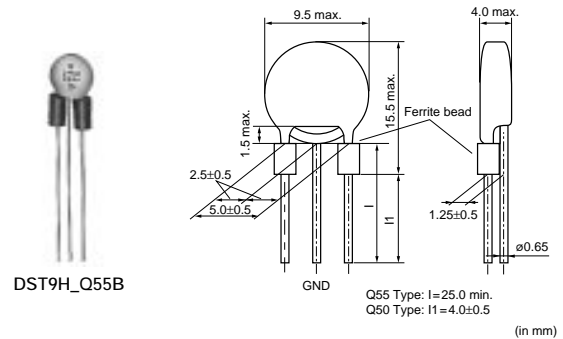

DSN9H Series

Part Number	Capacitance (pF)	Rated Voltage (Vdc)	Rated Current (A)	Operating Temperature Range (°C)
DSN9HB32E220	22 +20%,-20%	250	6	-40 to +105
DSN9HB32E101	100 +20%,-20%	250	6	-40 to +105
DSN9HB32E271	270 +20%,-20%	250	6	-40 to +105
DSN9HB32E222	2200 +20%,-20%	250	6	-40 to +105

Please refer to Part Numbering for Type and Length of Lead.

Equivalent Circuit



Insertion Loss Characteristics



Built-in Ferrite Beads DSS9H Series

Part Number	Capacitance (pF)	Rated Voltage (Vdc)	Rated Current (A)	Operating Temperature Range (°C)
DSS9HB32E220	22 +20%,-20%	250	6	-40 to +105
DSS9HB32E101	100 +20%,-20%	250	6	-40 to +105
DSS9HB32E271	270 +20%,-20%	250	6	-40 to +105
DSS9HB32E222	2200 +20%,-20%	250	6	-40 to +105

Please refer to Part Numbering for Type and Length of Lead.

Equivalent Circuit



Insertion Loss Characteristics

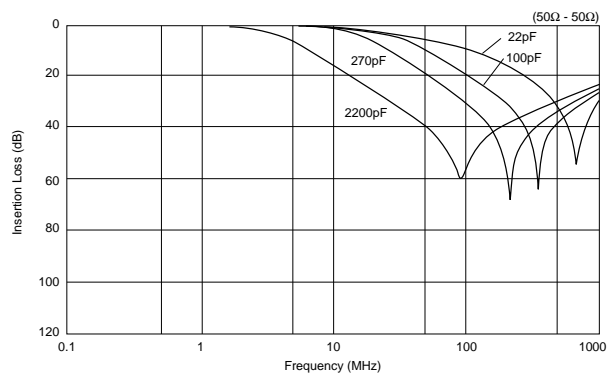

With Ferrite Beads DST9H Series

Part Number	Capacitance (pF)	Rated Voltage (Vdc)	Rated Current (A)	Operating Temperature Range (°C)
DST9HB32E220	22 +20%,-20%	250	6	-40 to +105
DST9HB32E101	100 +20%,-20%	250	6	-40 to +105
DST9HB32E271	270 +20%,-20%	250	6	-40 to +105
DST9HB32E222	2200 +20%,-20%	250	6	-40 to +105

Please refer to Part Numbering for Type and Length of Lead.

■ Equivalent Circuit

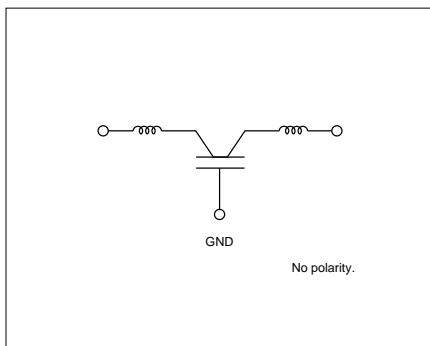

■ Insertion Loss Characteristics



On-Board Type (DC) EMI Suppression Filters (EMIFIL®)



Lead Type EMIGUARD® (EMIFIL® with Varistor Function) Part Numbering

Lead Type EMIGUARD® (EMIFIL® with Varistor Function)

(Part Number)

VF	S	6	V	D8	1E	221	T51	B
①	②	③	④	⑤	⑥	⑦	⑧	⑨

① Product ID

Product ID	
VF	EMIGUARD® Lead Type

② Structure

Code	Structure
S	Built-in Ferrite Beads Type
R	with Resistance

③ Style

Code	Style
3	Size is expressed by a figure
6	
9	

④ Features

Code	Features
V	with Varistor Function

⑤ Temperature Characteristics

Code	Capacitance Change
D8	+20/-30% (Temperature Range: -40°C to +105°C)
D3	+20/-30% (Temperature Range: -25°C to +85°C)

⑥ Rated Voltage

Code	Rated Voltage
1E	25V
1B	12V

⑦ Capacitance

Expressed by three figures. The unit is in pico-farad (pF). The first and second figures are significant digits, and the third figure expresses the number of zeros which follow the two figures.

⑧ Lead Type/⑨ Packaging

Code	Lead Type	Lead Length*	Packaging	Series
T51B	Incrimp	25.0mm min.	Bulk	VFR3/VFS6
U31A		18.5+/-1.0mm	Ammo Pack	
Q55B	Straight	25.0mm min.	Bulk	VFS9
Q91J		20.0+/-1.0mm	Paper Reel (ø320mm)	
Q92J		16.5+/-1.0mm		
Q93J		18.5+/-1.0mm		

*Lead Distance between Reference and Bottom Planes except Bulk.

On-Board Type (DC) EMI Suppression Filters (EMIFIL®)



Lead Type EMIGUARD® (EMIFIL® with Varistor Function) VFR3V/VFS6V/VFS9V Series

for Semiconductor Protection VFR3V Series

■ Features

VFR3V series is designed for ESD surge protection of IC. It efficiently absorbs ESD surges rushed into IC's I/O terminal.

■ Applications

Elimination of noise and protection of semiconductors in office equipment, including computers and peripheral equipment, copy machines, and communication terminals.

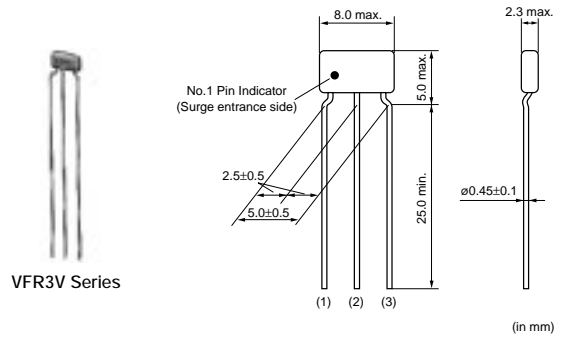

Part Number	Rated Voltage (Vdc)	Varistor Voltage (Vdc)	Capacitance (pF)	Rated Current (mA)	Peak Pulse Current (A)	Operating Temperature Range (°C)
VFR3VD31E131	25	50 +20%, -20%	130 +20%, -20%	20	30	-25 to 85

Please refer to Part Numbering for Type and Length of Lead.

■ Insertion Loss Characteristics

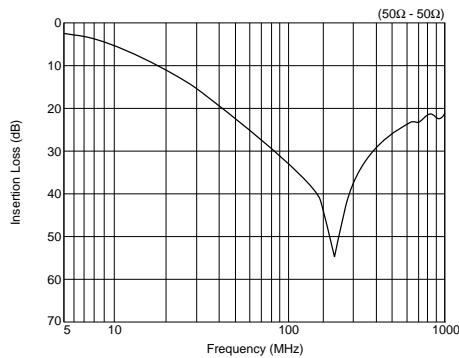

for Signal-Line VFS6V Series

■ Features

VFS6V series is designed for surge protection of signal line. It protects electric circuit from surges such as static electricity and suppresses EMI noise. Built-in ferrite bead gives excellent EMI suppression.

■ Applications

Elimination of noise and protection of electric circuits in office equipment, including computers and peripheral equipment, copy machines, and communication terminals.

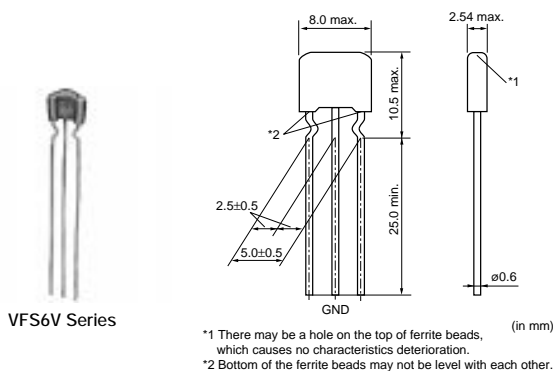

Part Number	Rated Voltage (Vdc)	Varistor Voltage (Vdc)	Capacitance (pF)	Rated Current (A)	Peak Pulse Current (A)	Operating Temperature Range (°C)
VFS6VD81E221	25	50 +20%, -20%	220 +20%, -20%	6	100	-40 to 105

Please refer to Part Numbering for Type and Length of Lead.

■ Equivalent Circuit

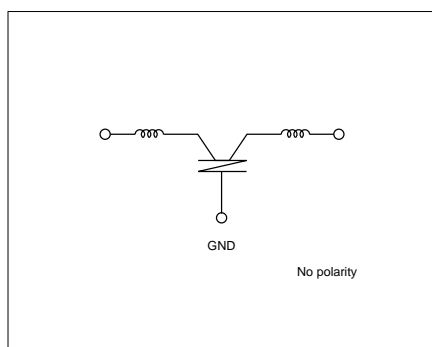

■ Insertion Loss Characteristics



for Large-Current VFS9V Series

■ Features

VFS9V series is designed for surge protection of the power supply. It protects electric circuits from surge such as static electricity and suppresses EMI noise. Its large capacitance value enables high insertion loss for EMI noise.

■ Applications

For circuit protection and noise suppression in electronics equipment such as computers and DC motors, and in electronics systems installed in cars such as car audio equipment and engine controllers.

■ Supplement

Diameter of lead is 0.6mm for taping type.
Taping type is three terminal in-line arrangement.



VFS9V Series

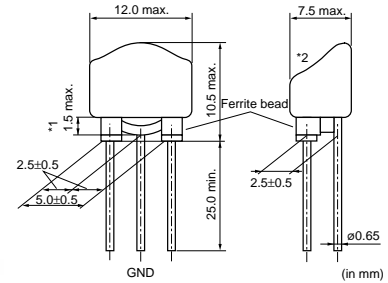

*1 Coating extending on leads does not exceed the tangent line. Exposed electrode, if any, is covered by solder, etc.
 *2 If there is a hole in the top of the filter, the ferrite bead should not be exposed.

Part Number	Rated Voltage (Vdc)	Varistor Voltage (Vdc)	Capacitance (pF)	Rated Current (A)	Operating Temperature Range (°C)
VFS9VD31B223	12	22 +20%,-20%	22000 +50%,-20%	7	-40 to 100

Rated current is 7A for bulk type and 6A for taping type.
 Rated current of taping type is 6A because diameter of lead is 0.6mm and its lead layout is in-line type.
 Please refer to Part Numbering for Type and Length of Lead.

■ Equivalent Circuit

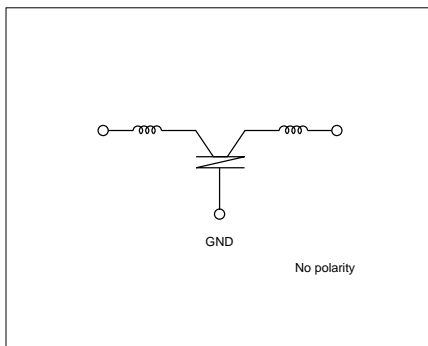

■ Insertion Loss Characteristics

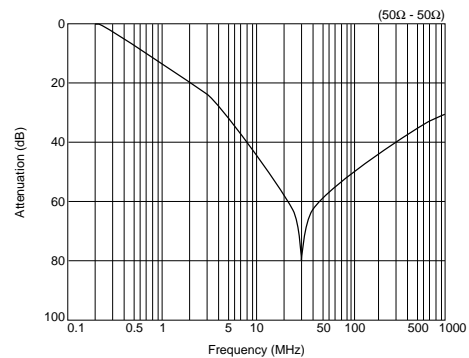

■ Voltage - Current Characteristics

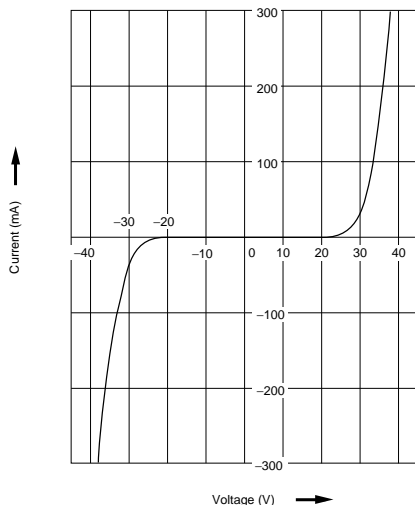

Noise Suppression Effect of VFR/VFS Series

■ Example of IC Protection (VFR3V)

● Testing Method

1. Put ESD surge to IC (7404 family) input terminal with ESD simulator based on IEC 801-2.
2. Check IC's operation.
3. If IC's operation is normal, increase ESD voltage in 1kV steps.
4. Continue above steps 1 to 3 till IC's operation becomes abnormal.



● Result

Varistor VFR3V can protect IC from ESD.

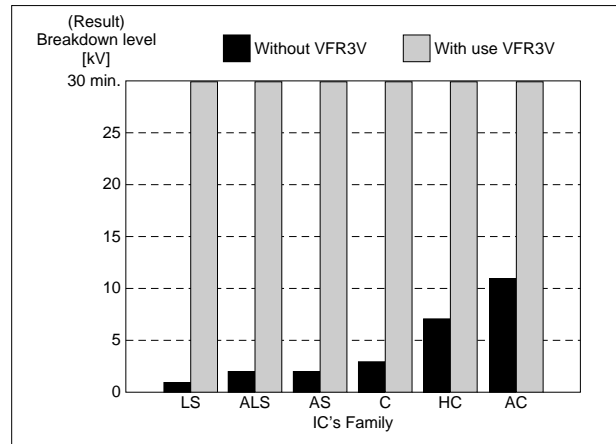

■ Example of EMI Suppression Effect

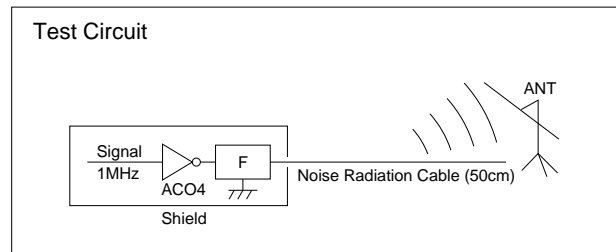

Type of Filter	EMI Suppression Effect
Before Countermeasures (No Filters)	
Use VFR3VD31E131T51	

Noise Suppression Effect of VFR/VFS Series

■Features (VFS9V)

Items	Test methods	Rated values										
Overload	1.4 times the varistor voltage (V_1) is applied for 5 minutes at room temperature.	<table border="1"> <thead> <tr> <th>Items</th> <th>Specifications</th> </tr> </thead> <tbody> <tr> <td>Rated Capacitance Change</td> <td>Within±15%</td> </tr> <tr> <td>Insulation Resistance</td> <td>500kΩ min.</td> </tr> <tr> <td>Rated of Change in Varistor Voltage V_1^*</td> <td>Within±15%</td> </tr> <tr> <td>Voltage Rate</td> <td>1.30 max.</td> </tr> </tbody> </table> <p>*V_1: Voltage when 1mA is applied</p>	Items	Specifications	Rated Capacitance Change	Within±15%	Insulation Resistance	500kΩ min.	Rated of Change in Varistor Voltage V_1^*	Within±15%	Voltage Rate	1.30 max.
Items	Specifications											
Rated Capacitance Change	Within±15%											
Insulation Resistance	500kΩ min.											
Rated of Change in Varistor Voltage V_1^*	Within±15%											
Voltage Rate	1.30 max.											
Surge Test (1)	At room temperature. Surges are applied are 10^5 times every 2 seconds. Then after 1 or 2 hours, the sample is measured.	<table border="1"> <thead> <tr> <th>Items</th> <th>Specifications</th> </tr> </thead> <tbody> <tr> <td>Rated Capacitance Change</td> <td>Within±15%</td> </tr> <tr> <td>Insulation Resistance</td> <td>500kΩ min.</td> </tr> <tr> <td>Rated of Change in Varistor Voltage V_1^*</td> <td>Within±15%</td> </tr> <tr> <td>Voltage Rate</td> <td>1.30 max.</td> </tr> </tbody> </table> <p>*V_1: Voltage when 1mA is applied</p>	Items	Specifications	Rated Capacitance Change	Within±15%	Insulation Resistance	500kΩ min.	Rated of Change in Varistor Voltage V_1^*	Within±15%	Voltage Rate	1.30 max.
Items	Specifications											
Rated Capacitance Change	Within±15%											
Insulation Resistance	500kΩ min.											
Rated of Change in Varistor Voltage V_1^*	Within±15%											
Voltage Rate	1.30 max.											
Surge Test (2)	At room temperature. Capacitor "C" is charged with 70V, then discharged to apply the voltage to the sample. Tested once (resuming JASO A-1).	<table border="1"> <thead> <tr> <th>Items</th> <th>Specifications</th> </tr> </thead> <tbody> <tr> <td>Rated Capacitance Change</td> <td>Within±15%</td> </tr> <tr> <td>Insulation Resistance</td> <td>500kΩ min.</td> </tr> <tr> <td>Rated of Change in Varistor Voltage V_1^*</td> <td>Within±15%</td> </tr> <tr> <td>Voltage Rate</td> <td>1.30 max.</td> </tr> </tbody> </table> <p>*V_1: Voltage when 1mA is applied</p>	Items	Specifications	Rated Capacitance Change	Within±15%	Insulation Resistance	500kΩ min.	Rated of Change in Varistor Voltage V_1^*	Within±15%	Voltage Rate	1.30 max.
Items	Specifications											
Rated Capacitance Change	Within±15%											
Insulation Resistance	500kΩ min.											
Rated of Change in Varistor Voltage V_1^*	Within±15%											
Voltage Rate	1.30 max.											
High Temperature Load	At a temperature of $85\pm 3^\circ\text{C}$, the varistor voltage V_1 is continuously applied to the sample for 1000 to 1024 hours. Then it is left at room temperature, for 4 to 24 hours before measuring.	<table border="1"> <thead> <tr> <th>Items</th> <th>Specifications</th> </tr> </thead> <tbody> <tr> <td>Rated Capacitance Change</td> <td>Within±15%</td> </tr> <tr> <td>Insulation Resistance</td> <td>500kΩ min.</td> </tr> <tr> <td>Rated of Change in Varistor Voltage V_1^*</td> <td>Within±15%</td> </tr> <tr> <td>Voltage Rate</td> <td>1.30 max.</td> </tr> </tbody> </table> <p>*V_1: Voltage when 1mA is applied</p>	Items	Specifications	Rated Capacitance Change	Within±15%	Insulation Resistance	500kΩ min.	Rated of Change in Varistor Voltage V_1^*	Within±15%	Voltage Rate	1.30 max.
Items	Specifications											
Rated Capacitance Change	Within±15%											
Insulation Resistance	500kΩ min.											
Rated of Change in Varistor Voltage V_1^*	Within±15%											
Voltage Rate	1.30 max.											

■Pulse-Voltage Breakdown Characteristic (VFS9V)
 VFS9V EMIGUARD® use a self healing varistor- capacitor, so that it can be used under a 500 to 600V surge which would break conventional disk type EMI filters. As shown in figure below EMIGUARD® withstands 2000V impulses applied 1000 times.

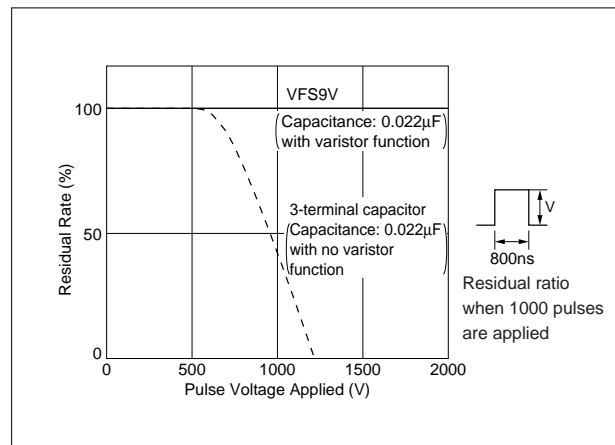
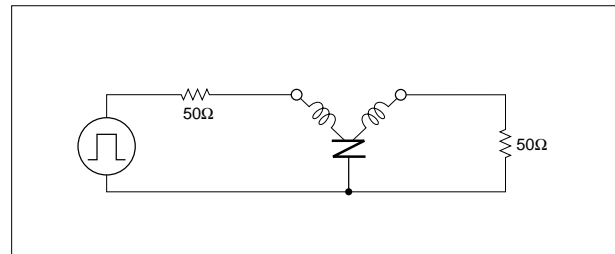

5

■Temperature Characteristics of Varistor Voltage - Insulation Resistance (VFS9V)

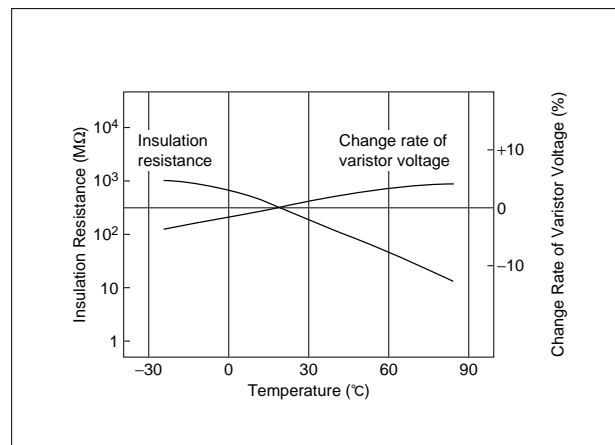

Continued on the following page. ↗

Noise Suppression Effect of VFR/VFS Series

Continued from the preceding page.

■ Noise Absorption Effect of EMIGUARD® (VFS9V)

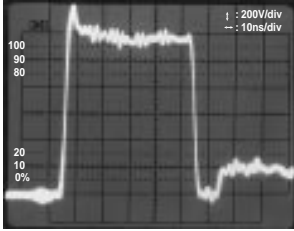
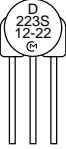
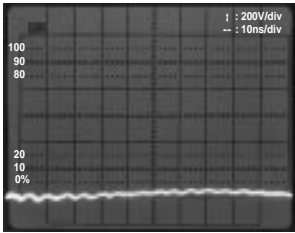
Type of Filter	EMI Suppression Effect	Description
without EMIGUARD®		Waveform when EMIGUARD® is not used. (Surge from a noise simulator)
with EMIGUARD® 		Waveform after the noise passed through EMIGUARD®. Little noise is recorded.

■ Comparative Data (VFS9V)

1. Absorption of quick-rising, high-frequency noise (10ns/div, 100V/div)

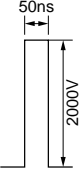
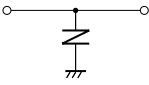
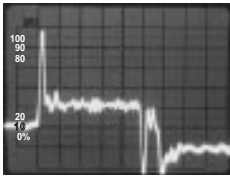
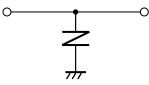
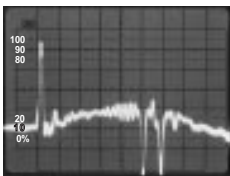
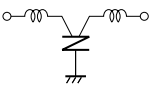
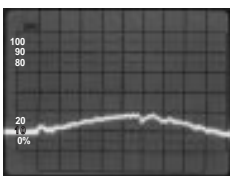



Type of Filter	EMI Suppression Effect	Description
without Filters	 Noise wave applied	
Conventional varistor	 	As with the two terminal capacitor
Two terminal capacitor (with varistor function)	 	The two terminal capacitor is influenced by lead line inductance, leaving behind some of the rising and falling edges. The residual noise can cause the system to malfunction.
VFS9V	 	The three terminal structure eliminates most of the lead line inductance. This allows VFS9V to completely absorb the rising and falling edges of the applied pulses.

Continued on the following page.

Noise Suppression Effect of VFR/VFS Series

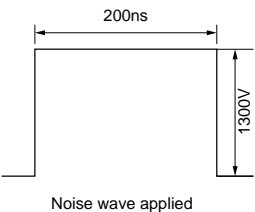
Continued from the preceding page.

2. Absorption of wide-pulse noise (50ns/div, 200V/div)

Type of Filter	EMI Suppression Effect	Description
without Filters		
Two terminal capacitor		In capacitors the voltage of the residual surge (1300V) is higher than that of the above example. The wave height is almost the same as the original.
Three terminal capacitor (with ferrite bead)		Conventional EMI filters do not work for wide-pulse noise because capacitors are saturated. In this example, the residual 1200V surge can cause the system to breakdown.
VFS9V		Bypassing the high voltage to the ground, voltage can be suppressed.

On-Board Type (DC) EMI Suppression Filters (EMIFIL®)



Common Mode Choke Coils Part Numbering

Common Mode Choke Coils

(Part Number)

PL	T	09H	N	200	3R0	P	1	B
①	②	③	④	⑤	⑥	⑦	⑧	⑨

① Product ID

Product ID	
PL	Common Mode Choke Coils

② Type

Code	Type
T	DC Type

③ Applications

Code	Applications
09H	for DC Line High-frequency Type

④ Features

Code	Features
N	General Use

⑨ Packaging

Code	Packaging	Series
B	Bulk	All series

⑤ Inductance

Expressed by three figures. The unit is micro-henry (μH). The first and second figures are significant digits, and the third figure expresses the number of zeros which follow the two figures.

⑥ Rated Current

Expressed by three-digit alphanumerics. The unit is in amperes (A). A decimal point is expressed by the capital letter "R". In this case, all figures are significant digits.

⑦ Winding Mode

Code	Winding Mode
P	Aligned Winding Type

⑧ Lead Dimensions

Code	Lead Dimensions
1	5mm

On-Board Type (DC) EMI Suppression Filters (EMIFIL®)



Common Mode Choke Coils (for DC Line) PLT09H Series

PLT09H series is a common mode choke coil for DC lines. It is effective against the common mode noise that can cause radiative noise in power supply lines and interface lines. The additional normal mode inductance enables high suppression effect to radiation noise.

■ Features

1. This is a wide frequency range type, applicable in applications ranging from a few MHz to several 100MHz.
2. It features a low-profile design.

■ Applications

1. Noise suppression of SW power supply, DC-DC converter
2. DC power lines in AC adapter of Portable equipment



PLT09H Series



(in mm)

Part Number	Inductance (min.) (μH)	Rated Current (A)	Rated Voltage (Vdc)	Withstand Voltage (Vdc)
PLT09HN2003R0P1	20 min.	3	50	125

Operating Temperature Range: -40°C to 85°C

■ Equivalent Circuit

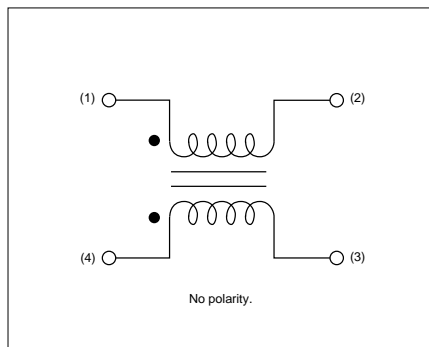

■ Insertion Loss Characteristics

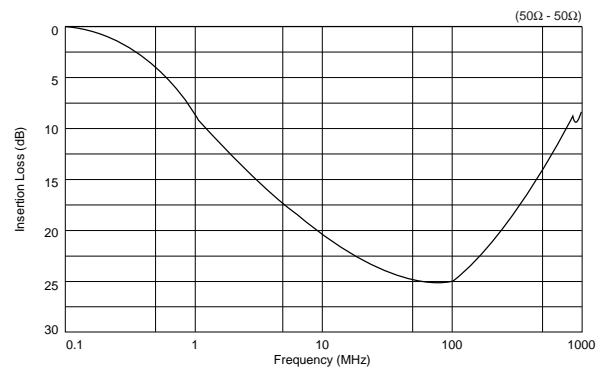

On-Board Type (DC) EMI Suppression Filters (EMIFIL®)



Microwave Absorbers Part Numbering

Microwave Absorber

(Part Number)

EA	1026	A	160	M	200	200
①	②	③	④	⑤	⑥	⑦

① Product ID

Product ID	
EA	Microwave Absorber

② Sheet Type

Code	Sheet Type
10□□	Iron carbonyl type (UL certified type/non Halogen type)
2070	Metal Flake Powder (non Halogen type)
2100	Metal Flake Powder (UL certified type)
2200	Metal Flake Powder (UL certified type/non Halogen type)
3008	Magnetic material (UL certified type/non Halogen type)

③ Adhesive Tape Type

Code	Adhesive Tape Type
A	Standard tape type (non Halogen type)
B	Thin Adhesive tape type (non Halogen type)
L	No tape type
U	UL certified type (non Halogen type)

④ Sheet Thickness

Expressed by 3 digits including the second decimal place in mm.

Ex.)

Code	Sheet Thickness
020	0.20mm

⑤ Unit of Dimension

One capital letter expresses Unit of Dimension (⑤) and Dimensions Length (⑦).

Code	Unit of Dimension
M	in mm (Standard)
C	in cm (Standard)

Standard shape is a rectangle.

Please contact us for other shapes.

⑥ Dimension (Length)

Expressed by 3 digits including the first decimal place.

⑦ Dimension (Width)

Expressed by 3 digits including the first decimal place.

Ex.)

Code	Dimension (Length × Width)
M300150	30.0×15.0 mm
C150100	15.0×10.0 cm

On-Board Type (DC) EMI Suppression Filters (EMIFIL®)



Microwave Absorbers EA10/20/21/22/30 Series

EA10 Series

When inquiring, please contact us with size code, referring to "Part Numbering".

■ Features

1. Excellent elasticity and durability with silicon rubber
2. Suitable for prevention of abnormal oscillation in high frequency modules, suppression of spurious spectra and prevention of interference between circuits
3. Holds easily in equipment with adhesive tape



EA10 Series

Part Number	Applicable Frequency (Typ.)	Thickness (Typ.) (mm)	Flame Resistance	Halogen	Operating Temperature Range
EA1026A100	20.0GHz	1.0	UL94V-0	Halogen Free	-40 to +80°C
EA1026A160	11.5GHz	1.6	UL94V-0	Halogen Free	-40 to +80°C
EA1026A180	10.0GHz	1.8	UL94V-0	Halogen Free	-40 to +80°C
EA1046A180	5.8GHz	1.8	UL94V-0	Halogen Free	-40 to +80°C
EA1075A270	2.5GHz	2.7	UL94V-0	Halogen Free	-40 to +80°C

■ Reflection Loss

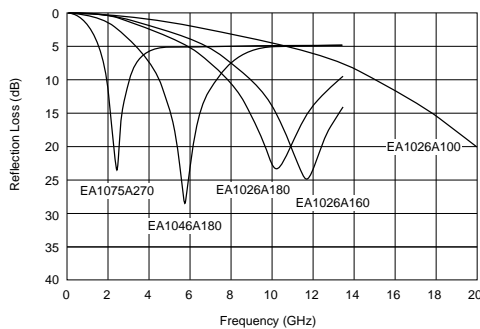

EA20/21/22 Series

When inquiring, please contact us with size code, referring to "Part Numbering".

■ Features

1. Magnetically-shielded high-micro and high-loss characteristics can suppress noise in a wide frequency band for digital equipment.
2. Thin (0.2mm-1.0mm) and flexible sheet makes easy handling in assembly process.
3. Holds easily in equipment with adhesive tape
4. EA20xx series: Non Halogen type
EA21xx series: UL94V-0 certified material is used
EA22xx series: Non Halogen type and UL94V-0 certified material is used



EA20/21/22 Series

Part Number	Applicable Frequency (Typ.)	Thickness (Typ.) (mm)	Flame Resistance	Halogen	Operating Temperature Range
EA2070A020	0.1 to 3.0GHz	0.20	-	Halogen Free	-40 to +120°C
EA2070A050	0.1 to 3.0GHz	0.50	-	Halogen Free	-40 to +120°C
EA2070A100	0.1 to 3.0GHz	1.00	-	Halogen Free	-40 to +120°C
EA2070B005	0.1 to 3.0GHz	0.05	-	Halogen Free	-40 to +120°C
EA2070B010	0.1 to 3.0GHz	0.10	-	Halogen Free	-40 to +120°C
EA2070B013	0.1 to 3.0GHz	0.13	-	Halogen Free	-40 to +120°C
EA2070B020	0.1 to 3.0GHz	0.20	-	Halogen Free	-40 to +120°C
EA2070B050	0.1 to 3.0GHz	0.50	-	Halogen Free	-40 to +120°C
EA2100A020	0.1 to 3.0GHz	0.20	UL94V-0	-	-40 to +120°C
EA2100A050	0.1 to 3.0GHz	0.50	UL94V-0	-	-40 to +120°C
EA2100A100	0.1 to 3.0GHz	1.00	UL94V-0	-	-40 to +120°C
EA2100B020	0.1 to 3.0GHz	0.20	UL94V-0	-	-40 to +120°C
EA2100B050	0.1 to 3.0GHz	0.50	UL94V-0	-	-40 to +120°C
EA2100B100	0.1 to 3.0GHz	1.00	UL94V-0	-	-40 to +120°C
EA2200A010	0.1 to 3.0GHz	0.1	UL94V-0	Halogen Free	-40 to +120°C
EA2200A020	0.1 to 3.0GHz	0.2	UL94V-0	Halogen Free	-40 to +120°C
EA2200A050	0.1 to 3.0GHz	0.5	UL94V-0	Halogen Free	-40 to +120°C
EA2200A100	0.1 to 3.0GHz	1.0	UL94V-0	Halogen Free	-40 to +120°C
EA2200B010	0.1 to 3.0GHz	0.1	UL94V-0	Halogen Free	-40 to +120°C
EA2200B020	0.1 to 3.0GHz	0.2	UL94V-0	Halogen Free	-40 to +120°C
EA2200B050	0.1 to 3.0GHz	0.5	UL94V-0	Halogen Free	-40 to +120°C
EA2200B100	0.1 to 3.0GHz	1.0	UL94V-0	Halogen Free	-40 to +120°C

■ Magnetic Permeability - Reluctance (Typical)

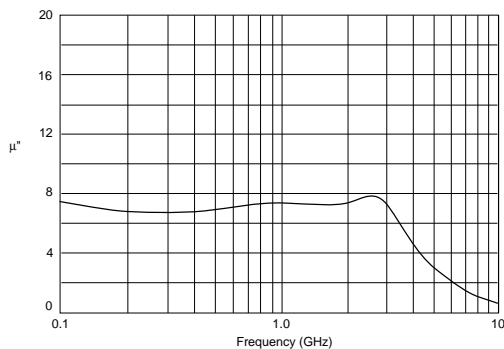

EA30 Series

When inquiring, please contact us with size code, referring to "Part Numbering".

■ Features

1. EMC Absorber magnetically shields and suppresses noise of digital equipment.
2. Flexible sheet, easy handling in assembly process.
3. Holds easily in equipment with adhesive tape.
4. Halogen free and UL94V-0 certified material are used.



EA30 Series

Part Number	Applicable Frequency (Typ.)	Thickness (Typ.) (mm)	Flame Resistance	Halogen	Operating Temperature Range
EA3008U025	0.1 to 3.0GHz	0.25	UL94V-0	Halogen Free	-40 to +120°C
EA3008U035	0.1 to 3.0GHz	0.35	UL94V-0	Halogen Free	-40 to +120°C
EA3008U050	0.1 to 3.0GHz	0.50	UL94V-0	Halogen Free	-40 to +120°C
EA3008U100	0.1 to 3.0GHz	1.00	UL94V-0	Halogen Free	-40 to +120°C
EA3008U250	0.1 to 3.0GHz	2.50	UL94V-0	Halogen Free	-40 to +120°C

■ Magnetic Permeability - Reluctance (Typical)



Chip EMIFIL® ⚠ Caution/Notice

■ ⚠ Caution (Rating)

Do not use products beyond the rated current and rated voltage as this may create excessive heat and deteriorate the insulation resistance.

■ ⚠ Caution (Soldering and Mounting)

1. Self-heating

Please provide special attention when mounting chip "EMIFIL" (BLM_P/K/S, NFM_P) series in close proximity to other products that radiate heat.

The heat generated by other products may deteriorate the insulation resistance and cause excessive heat in this component.

2. Mounting Direction

Mount Chip Common Mode Choke Coils in right direction. Wrong direction, which is 90 degrees rotated from right direction, causes not only open or short circuit but also flames or other serious trouble.



■ Notice (Storage and Operating Conditions)

<Operating Environment>

Do not use products in a chemical atmosphere such as chlorine gas, acid or sulfide gas.

<Storage and Handling requirements>

1. Storage Period

BLM (except BLM15E/15H/15G series) /BLA/NFM55/DLM11G/DLM2HG series should be used within 6 months, the other series should be used within 12 months.

Solderability should be checked if this period is exceeded.

2. Storage Conditions

(1) Storage temperature: -10 to 40 degrees C

Relative humidity: 30 to 70%

Avoid sudden changes in temperature and humidity.

(2) Do not store products in a chemical atmosphere such as chlorine gas, acid or sulfide gas.

■ Notice (Soldering and Mounting)

1. Washing

Failure and degradation of a product are caused by the washing method. When you wash in conditions that are not in mounting information, please contact Murata engineering.

2. Soldering

Reliability decreases with improper soldering methods. Please solder by the standard soldering conditions shown in mounting information.

3. Other

Noise suppression levels resulting from Murata's EMI suppression filters "EMIFIL" may vary, depending on the circuits and ICs used, type of noise, mounting pattern, lead wire length, mounting location, and other operating conditions. Be sure to check and confirm in advance the noise suppression effect of each filter, in actual circuits, etc. before applying the filter in a commercial-purpose equipment design.

Chip EMIFIL® ⚠ Caution/Notice

■ Notice (Handling)

1. Resin coating (Except DLW Series)

Using resin for coating/molding products may affect the products performance.

So please pay careful attention in selecting resin.

Prior to use, please make the reliability evaluation with the product mounted in your application set.

2. Resin coating (DLW Series)

The impedance value may change due to high cure-stress of resin to be used for coating/molding products. An open circuit issue may occur by mechanical stress caused by the resin, amount/cured shape of resin, or operating condition etc. Some resin contains some impurities or chloride possible to generate chlorine by hydrolysis under some operating condition may cause corrosion of wire of coil, leading to open circuit.

So, please pay your careful attention in selecting resin in case of coating/molding the products with the resin. Prior to use the coating resin, please make sure no reliability issue is observed by evaluating products mounted on your board.

3. Caution for use (DLW/NFW Series)

When you hold products with a tweezer, please hold by the sides. Sharp materials, such as a pair of tweezers, should not touch the winding portion to prevent breaking the wire. Mechanical shock should not be applied to the products mounted on the board to prevent breaking the core.

Lead Type EMIFIL® ⚠Caution/Notice

■ ⚠Caution (Rating)

Do not use products beyond the rated current and rated voltage as this may create excessive heat and deteriorate the insulation resistance.

■ ⚠Caution (Soldering and Mounting)

Mounting holes should be designed as specified in these specifications. Other designs than shown in these specifications may cause cracks in ceramics which may lead to smoking or firing.

■ Notice (Storage and Operating Conditions)

<Operating Environment>

1. Do not use products in a chemical atmosphere such as chlorine gas, acid or sulfide gas.
2. Do not use products near water, oil or organic solvents. Avoid environment where dust or dirt may adhere to product.

<Concerning "EMIGUARD">

VFR3V series is designed only to absorb electrostatic surges. Do not use this product to absorb large energy surges such as lighting or switching related surges.

<Storage and Handling Requirements>

1. Storage Period

Used the products within 12 months after delivery.
Solderability should be checked if this period is exceeded.

■ Notice (Soldering and Mounting)

1. Washing

Failure and degradation of a product are caused by the washing method. When you wash in conditions that are not in mounting information, please contact Murata engineering.

2. Soldering

Reliability decreases with improper soldering methods. Please solder by the standard soldering conditions shown in mounting information.

2. Storage Conditions

- (1) Storage temperature: -10 to 40 degrees C
Relative humidity: 30 to 70%
Avoid sudden changes in temperature and humidity.
- (2) Do not store products in a chemical atmosphere such as chlorine gas, acid or sulfide gas.
- (3) When restoring taping type (BL01RN1A1F1J), please attach the Spacer between flanges of reel. The Spacer is corrugated paper which is attached when shipping.

3. Other

Noise suppression levels resulting from Murata's EMI suppression filters "EMIFIL" may vary, depending on the circuits and ICs used, type of noise, mounting pattern, lead wire length, mounting location, and other operating conditions. Be sure to check and confirm in advance the noise suppression effect of each filter, in actual circuits, etc. before applying the filter in a commercial-purpose equipment design.

Microwave Absorbers Notice

■ Notice (Storage and Operating Conditions)

1. Adhesive Tape Stress

This product is designed for using the adhesive tape to hold itself to the object.

And please avoid causing mechanical stress by bending or variation of the object.

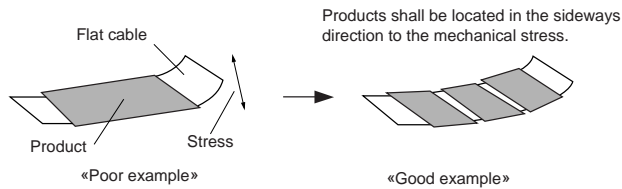

2. Cleaning

Avoid cleaning product.

3. Handling of the product

Adhesive tape must be clean to maintain the quality of tape.

And please wipe off any dirt, dust and any kind of oil from the surface of the object before use.

4. Storage Conditions

(1) Storage period

Products which were inspected in Murata over 6 months ago should be examined and used. This can be confirmed with inspection No. marked on the container. Adhesiveness should be checked if this period is exceeded.

(2) Storage conditions

• Products should be stored in the warehouse on the following conditions.

Temperature: -10 to 40°C

Humidity: 30 to 70% relative humidity

No rapid change on temperature and humidity

• Products should be stored in the warehouse without heat shock, vibration, direct sunlight and so on.

EMIFIL® (Soldering and Mounting)

1. Standard Land Pattern Dimensions

NF□ series suppress noise by conducting the high-frequency noise element to ground. Therefore, to obtain maximum performance from these filters, the ground pattern should be made as large as possible during the PCB design stage. As shown below, one side of the PCB is used for chip mounting, and the other is used for grounding. Small diameter feedthrough holes are then used to connect the grounds on each side of the PCB. This reduces the high-frequency impedance of the grounding and maximizes the filter's performance.

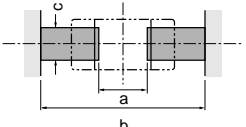
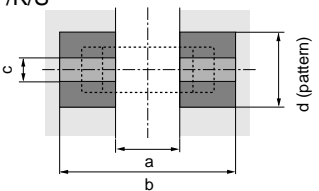

<p>BLM02 BLM03 BLM15 (Except BLM 15A_AN series) BLM18 BLM21 BLM31 BLM41</p>	<p>●Reflow and Flow BLM Series</p>  <table border="1" style="width: 100%; border-collapse: collapse; margin-top: 10px;"> <thead> <tr> <th>Type</th> <th>Soldering</th> <th>a</th> <th>b</th> <th>c</th> </tr> </thead> <tbody> <tr> <td>BLM02</td> <td>Reflow</td> <td>0.16-0.2</td> <td>0.4-0.56</td> <td>0.2-0.23</td> </tr> <tr> <td>BLM03</td> <td>Reflow</td> <td>0.2-0.3</td> <td>0.6-0.9</td> <td>0.3</td> </tr> <tr> <td>BLM15</td> <td>Reflow</td> <td>0.4</td> <td>1.2-1.4</td> <td>0.5</td> </tr> <tr> <td rowspan="2">BLM18</td> <td>Flow (except 18G)</td> <td rowspan="2">0.7</td> <td>2.2-2.6</td> <td rowspan="2">0.7</td> </tr> <tr> <td>Reflow</td> <td>1.8-2.0</td> </tr> <tr> <td>BLM21</td> <td>Flow/ Reflow</td> <td>1.2</td> <td>3.0-4.0</td> <td>1.0</td> </tr> </tbody> </table> <p>• Except BLM03PG/15PD-PG/18PG-KG-SG/21PG. And BLM02/03/15/18G is specially adapted for reflow soldering.</p>	Type	Soldering	a	b	c	BLM02	Reflow	0.16-0.2	0.4-0.56	0.2-0.23	BLM03	Reflow	0.2-0.3	0.6-0.9	0.3	BLM15	Reflow	0.4	1.2-1.4	0.5	BLM18	Flow (except 18G)	0.7	2.2-2.6	0.7	Reflow	1.8-2.0	BLM21	Flow/ Reflow	1.2	3.0-4.0	1.0	<p>BLM□□P/K/S</p>  <table border="1" style="width: 100%; border-collapse: collapse; margin-top: 10px;"> <thead> <tr> <th rowspan="2">Type</th> <th rowspan="2">Rated Current (A)</th> <th rowspan="2">Soldering</th> <th rowspan="2">a</th> <th rowspan="2">b</th> <th rowspan="2">c</th> <th colspan="3">Land pad thickness and dimension d</th> </tr> <tr> <th>18μm</th> <th>35μm</th> <th>70μm</th> </tr> </thead> <tbody> <tr> <td rowspan="3">BLM03PG</td> <td>0.75-0.9</td> <td>Reflow</td> <td>0.2-0.3</td> <td>0.6-0.9</td> <td>0.3</td> <td>0.3</td> <td>0.3</td> </tr> <tr> <td rowspan="2">1.3-1.5</td> <td rowspan="2">Reflow</td> <td rowspan="2">0.4</td> <td rowspan="2">1.2-1.4</td> <td rowspan="2">0.5</td> <td>0.5</td> <td>0.5</td> </tr> <tr> <td>1.2</td> <td>0.7</td> </tr> <tr> <td>BLM15PD</td> <td>1.7-2.2</td> <td>Reflow</td> <td>0.4</td> <td>1.2-1.4</td> <td>0.5</td> <td>0.5</td> <td>0.5</td> </tr> <tr> <td>BLM15PG</td> <td>1</td> <td>Reflow</td> <td>0.4</td> <td>1.2-1.4</td> <td>0.5</td> <td>0.5</td> <td>0.5</td> </tr> <tr> <td rowspan="3">BLM18PG</td> <td>0.5-1.5</td> <td rowspan="3">Flow/ Reflow</td> <td rowspan="3">0.7</td> <td rowspan="3">2.2-2.6 Reflow 1.8-2.0</td> <td rowspan="3">0.7</td> <td>0.7</td> <td>0.7</td> </tr> <tr> <td>2</td> <td>1.2</td> <td>0.7</td> </tr> <tr> <td>3</td> <td>2.4</td> <td>1.2</td> </tr> <tr> <td rowspan="4">BLM18KG</td> <td>1.3-1.5</td> <td rowspan="4">Flow/ Reflow</td> <td rowspan="4">0.7</td> <td rowspan="4">2.2-2.6 Reflow 1.8-2.0</td> <td rowspan="4">0.7</td> <td>0.7</td> <td>0.7</td> </tr> <tr> <td>1.7-2.2</td> <td>1.2</td> <td>0.7</td> </tr> <tr> <td>3-3.5</td> <td>2.4</td> <td>1.2</td> </tr> <tr> <td>6</td> <td>6.4</td> <td>3.3</td> </tr> <tr> <td rowspan="4">BLM18SG</td> <td>1.5</td> <td rowspan="4">Flow/ Reflow</td> <td rowspan="4">0.7</td> <td rowspan="4">2.2-2.6 Reflow 1.8-2.0</td> <td rowspan="4">0.7</td> <td>0.7</td> <td>0.7</td> </tr> <tr> <td>2.5</td> <td>1.2</td> <td>0.7</td> </tr> <tr> <td>3-4</td> <td>2.4</td> <td>1.2</td> </tr> <tr> <td>6</td> <td>6.4</td> <td>3.3</td> </tr> <tr> <td rowspan="4">BLM21PG</td> <td>1.5</td> <td rowspan="4">Flow/ Reflow</td> <td rowspan="4">1.2</td> <td rowspan="4">3.0-4.0</td> <td rowspan="4">1.0</td> <td>1.0</td> <td>1.0</td> </tr> <tr> <td>2</td> <td>1.2</td> <td>1.0</td> </tr> <tr> <td>3</td> <td>2.4</td> <td>1.2</td> </tr> <tr> <td>6</td> <td>6.4</td> <td>3.3</td> </tr> <tr> <td rowspan="3">BLM31PG</td> <td>1.5/2</td> <td rowspan="3">Flow/ Reflow</td> <td rowspan="3">2.0</td> <td rowspan="3">4.2-5.2</td> <td rowspan="3">1.2</td> <td>1.2</td> <td>1.2</td> </tr> <tr> <td>3</td> <td>2.4</td> <td>1.2</td> </tr> <tr> <td>6</td> <td>6.4</td> <td>3.3</td> </tr> <tr> <td rowspan="3">BLM41PG</td> <td>1-2</td> <td rowspan="3">Flow/ Reflow</td> <td rowspan="3">3.0</td> <td rowspan="3">5.5-6.5</td> <td rowspan="3">1.2</td> <td>1.2</td> <td>1.2</td> </tr> <tr> <td>3</td> <td>2.4</td> <td>1.2</td> </tr> <tr> <td>6</td> <td>6.4</td> <td>3.3</td> </tr> </tbody> </table> <p>• Do not apply narrower pattern than listed above to BLM□□P/K/S. Narrow pattern can cause excessive heat or open circuit.</p>	Type	Rated Current (A)	Soldering	a	b	c	Land pad thickness and dimension d			18μm	35μm	70μm	BLM03PG	0.75-0.9	Reflow	0.2-0.3	0.6-0.9	0.3	0.3	0.3	1.3-1.5	Reflow	0.4	1.2-1.4	0.5	0.5	0.5	1.2	0.7	BLM15PD	1.7-2.2	Reflow	0.4	1.2-1.4	0.5	0.5	0.5	BLM15PG	1	Reflow	0.4	1.2-1.4	0.5	0.5	0.5	BLM18PG	0.5-1.5	Flow/ Reflow	0.7	2.2-2.6 Reflow 1.8-2.0	0.7	0.7	0.7	2	1.2	0.7	3	2.4	1.2	BLM18KG	1.3-1.5	Flow/ Reflow	0.7	2.2-2.6 Reflow 1.8-2.0	0.7	0.7	0.7	1.7-2.2	1.2	0.7	3-3.5	2.4	1.2	6	6.4	3.3	BLM18SG	1.5	Flow/ Reflow	0.7	2.2-2.6 Reflow 1.8-2.0	0.7	0.7	0.7	2.5	1.2	0.7	3-4	2.4	1.2	6	6.4	3.3	BLM21PG	1.5	Flow/ Reflow	1.2	3.0-4.0	1.0	1.0	1.0	2	1.2	1.0	3	2.4	1.2	6	6.4	3.3	BLM31PG	1.5/2	Flow/ Reflow	2.0	4.2-5.2	1.2	1.2	1.2	3	2.4	1.2	6	6.4	3.3	BLM41PG	1-2	Flow/ Reflow	3.0	5.5-6.5	1.2	1.2	1.2	3	2.4	1.2	6	6.4	3.3
Type	Soldering	a	b	c																																																																																																																																																																								
BLM02	Reflow	0.16-0.2	0.4-0.56	0.2-0.23																																																																																																																																																																								
BLM03	Reflow	0.2-0.3	0.6-0.9	0.3																																																																																																																																																																								
BLM15	Reflow	0.4	1.2-1.4	0.5																																																																																																																																																																								
BLM18	Flow (except 18G)	0.7	2.2-2.6	0.7																																																																																																																																																																								
	Reflow		1.8-2.0																																																																																																																																																																									
BLM21	Flow/ Reflow	1.2	3.0-4.0	1.0																																																																																																																																																																								
Type	Rated Current (A)	Soldering	a	b	c	Land pad thickness and dimension d																																																																																																																																																																						
						18μm	35μm	70μm																																																																																																																																																																				
BLM03PG	0.75-0.9	Reflow	0.2-0.3	0.6-0.9	0.3	0.3	0.3																																																																																																																																																																					
	1.3-1.5	Reflow	0.4	1.2-1.4	0.5	0.5	0.5																																																																																																																																																																					
						1.2	0.7																																																																																																																																																																					
BLM15PD	1.7-2.2	Reflow	0.4	1.2-1.4	0.5	0.5	0.5																																																																																																																																																																					
BLM15PG	1	Reflow	0.4	1.2-1.4	0.5	0.5	0.5																																																																																																																																																																					
BLM18PG	0.5-1.5	Flow/ Reflow	0.7	2.2-2.6 Reflow 1.8-2.0	0.7	0.7	0.7																																																																																																																																																																					
	2					1.2	0.7																																																																																																																																																																					
	3					2.4	1.2																																																																																																																																																																					
BLM18KG	1.3-1.5	Flow/ Reflow	0.7	2.2-2.6 Reflow 1.8-2.0	0.7	0.7	0.7																																																																																																																																																																					
	1.7-2.2					1.2	0.7																																																																																																																																																																					
	3-3.5					2.4	1.2																																																																																																																																																																					
	6					6.4	3.3																																																																																																																																																																					
BLM18SG	1.5	Flow/ Reflow	0.7	2.2-2.6 Reflow 1.8-2.0	0.7	0.7	0.7																																																																																																																																																																					
	2.5					1.2	0.7																																																																																																																																																																					
	3-4					2.4	1.2																																																																																																																																																																					
	6					6.4	3.3																																																																																																																																																																					
BLM21PG	1.5	Flow/ Reflow	1.2	3.0-4.0	1.0	1.0	1.0																																																																																																																																																																					
	2					1.2	1.0																																																																																																																																																																					
	3					2.4	1.2																																																																																																																																																																					
	6					6.4	3.3																																																																																																																																																																					
BLM31PG	1.5/2	Flow/ Reflow	2.0	4.2-5.2	1.2	1.2	1.2																																																																																																																																																																					
	3					2.4	1.2																																																																																																																																																																					
	6					6.4	3.3																																																																																																																																																																					
BLM41PG	1-2	Flow/ Reflow	3.0	5.5-6.5	1.2	1.2	1.2																																																																																																																																																																					
	3					2.4	1.2																																																																																																																																																																					
	6					6.4	3.3																																																																																																																																																																					

Continued on the following page. ↗

EMIFIL[®] (Soldering and Mounting)

Continued from the preceding page.

Land Pattern
 + Solder Resist
 Land Pattern
 Solder Resist
 (in mm)

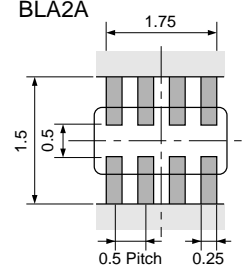
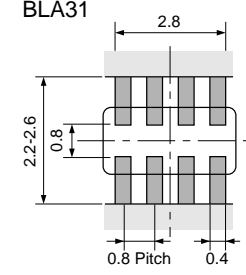
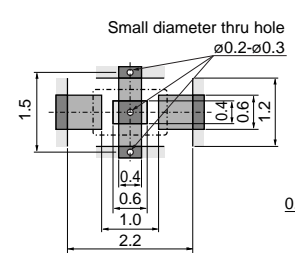
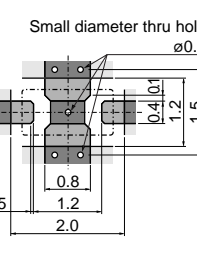
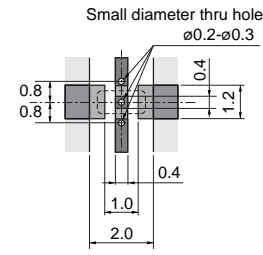
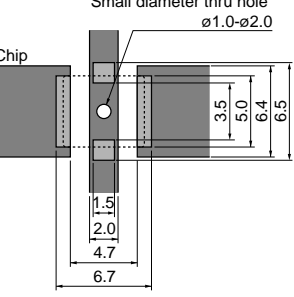
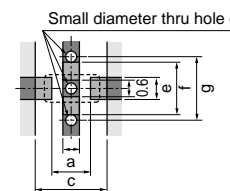
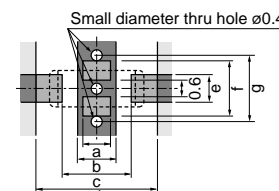
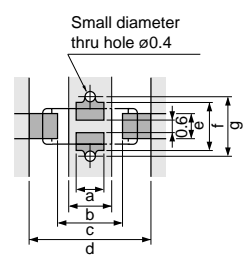
BLA2A BLA31	<p>● Reflow soldering</p> <p>BLA2A</p>  <p>● Reflow and Flow</p> <p>BLA31</p>  <p>• If there are high amounts of self-heating on pattern, the contact points of PCB and part may become damaged.</p>																																																																																																							
NFM18 NFL18 NFM55	<p>Reflow Soldering</p> <p>NFM18C/NFM18PC/ NFL18ST</p>  <p>NFM18PS</p>  <p>NFL18SP</p>  <p>NFM55P</p>  <p>The chip EMI filter suppresses noise by conducting the high-frequency noise to ground. Therefore, to get enough noise reduction, feed through holes which are connected to ground-plane should be arranged according to the figure to reinforce the ground pattern.</p> <p>• NFM□18, NFM□21, NFM55 are specially adapted for reflow soldering.</p> <p style="text-align: right;">Please contact us if using thinner land pad than 18µm.</p>																																																																																																							
NFM21 NFM3D NFM31P NFM41 NFR21G NFL21S	<p>● Reflow Soldering Chip mounting side</p> <p>NFM21C/NFR21G NFM21P/NFL21S</p>  <p>NFM3DC/NFM3DP/ NFM31P NFM41C/NFM41P</p>  <table border="1" style="width: 100%; border-collapse: collapse; margin-top: 10px;"> <thead> <tr> <th rowspan="2">Part Number</th> <th colspan="7">Size (mm)</th> </tr> <tr> <th>a</th> <th>b</th> <th>c</th> <th>d</th> <th>e</th> <th>f</th> <th>g</th> </tr> </thead> <tbody> <tr> <td>NFM21C/NFR21G</td> <td>0.6</td> <td>-</td> <td>1.4</td> <td>2.6</td> <td>0.8</td> <td>1.9</td> <td>2.3</td> </tr> <tr> <td>NFM21P/NFL21S</td> <td>1.0</td> <td>1.4</td> <td>2.5</td> <td>4.4</td> <td>1.0</td> <td>2.0</td> <td>2.4</td> </tr> <tr> <td>NFM3DC/NFM3DP</td> <td>1.0</td> <td>1.4</td> <td>2.5</td> <td>4.4</td> <td>1.2</td> <td>2.6</td> <td>3.0</td> </tr> <tr> <td>NFM41C</td> <td>1.5</td> <td>2.0</td> <td>3.5</td> <td>6.0</td> <td>1.2</td> <td>2.6</td> <td>3.0</td> </tr> <tr> <td>NFM41P</td> <td>1.5</td> <td>2.0</td> <td>3.5</td> <td>6.0</td> <td>1.2</td> <td>2.6</td> <td>3.0</td> </tr> </tbody> </table>	Part Number	Size (mm)							a	b	c	d	e	f	g	NFM21C/NFR21G	0.6	-	1.4	2.6	0.8	1.9	2.3	NFM21P/NFL21S	1.0	1.4	2.5	4.4	1.0	2.0	2.4	NFM3DC/NFM3DP	1.0	1.4	2.5	4.4	1.2	2.6	3.0	NFM41C	1.5	2.0	3.5	6.0	1.2	2.6	3.0	NFM41P	1.5	2.0	3.5	6.0	1.2	2.6	3.0	<p>● Flow Soldering Chip mounting side</p>  <table border="1" style="width: 100%; border-collapse: collapse; margin-top: 10px;"> <thead> <tr> <th rowspan="2">Part Number</th> <th colspan="7">Size (mm)</th> </tr> <tr> <th>a</th> <th>b</th> <th>c</th> <th>d</th> <th>e</th> <th>f</th> <th>g</th> </tr> </thead> <tbody> <tr> <td>NFM3DC</td> <td>1.0</td> <td>1.4</td> <td>2.5</td> <td>4.4</td> <td>1.0</td> <td>2.0</td> <td>2.4</td> </tr> <tr> <td>NFM3DP</td> <td>1.0</td> <td>1.4</td> <td>2.5</td> <td>4.4</td> <td>1.2</td> <td>2.6</td> <td>3.0</td> </tr> <tr> <td>NFM41C</td> <td>1.5</td> <td>2.0</td> <td>3.5</td> <td>6.0</td> <td>1.2</td> <td>2.6</td> <td>3.0</td> </tr> <tr> <td>NFM41P</td> <td>1.5</td> <td>2.0</td> <td>3.5</td> <td>6.0</td> <td>1.2</td> <td>2.6</td> <td>3.0</td> </tr> </tbody> </table>	Part Number	Size (mm)							a	b	c	d	e	f	g	NFM3DC	1.0	1.4	2.5	4.4	1.0	2.0	2.4	NFM3DP	1.0	1.4	2.5	4.4	1.2	2.6	3.0	NFM41C	1.5	2.0	3.5	6.0	1.2	2.6	3.0	NFM41P	1.5	2.0	3.5	6.0	1.2	2.6	3.0
Part Number	Size (mm)																																																																																																							
	a	b	c	d	e	f	g																																																																																																	
NFM21C/NFR21G	0.6	-	1.4	2.6	0.8	1.9	2.3																																																																																																	
NFM21P/NFL21S	1.0	1.4	2.5	4.4	1.0	2.0	2.4																																																																																																	
NFM3DC/NFM3DP	1.0	1.4	2.5	4.4	1.2	2.6	3.0																																																																																																	
NFM41C	1.5	2.0	3.5	6.0	1.2	2.6	3.0																																																																																																	
NFM41P	1.5	2.0	3.5	6.0	1.2	2.6	3.0																																																																																																	
Part Number	Size (mm)																																																																																																							
	a	b	c	d	e	f	g																																																																																																	
NFM3DC	1.0	1.4	2.5	4.4	1.0	2.0	2.4																																																																																																	
NFM3DP	1.0	1.4	2.5	4.4	1.2	2.6	3.0																																																																																																	
NFM41C	1.5	2.0	3.5	6.0	1.2	2.6	3.0																																																																																																	
NFM41P	1.5	2.0	3.5	6.0	1.2	2.6	3.0																																																																																																	

Continued on the following page. ↗

EMIFIL® (Soldering and Mounting)

Continued from the preceding page.

Land Pattern
 + Solder Resist
 Land Pattern
 Solder Resist
 (in mm)

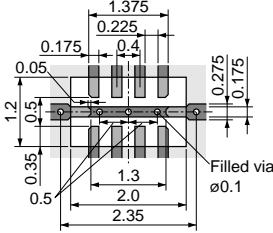
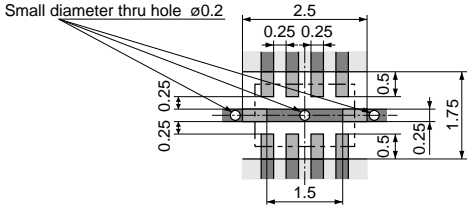
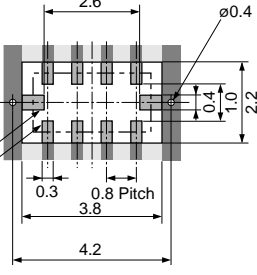
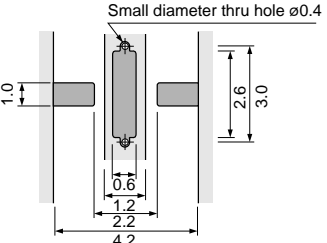
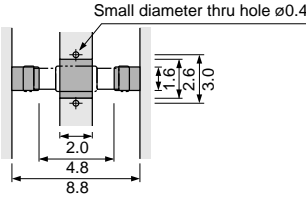
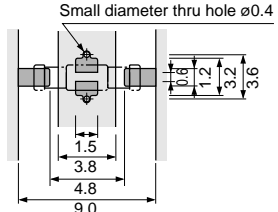
NFA18S NFA21S	Reflow Soldering Chip mounting side NFA18S 	NFA21S 
NFA31G NFA31C NFW31S NFE31P	<ul style="list-style-type: none"> ● Reflow Soldering NFA31G/31C 	<ul style="list-style-type: none"> ● Reflow and Flow NFW31S ● Reflow Soldering NFE31P Chip mounting side 
NFE61P	<ul style="list-style-type: none"> ● Reflow Soldering Chip mounting side 	<ul style="list-style-type: none"> ● Flow Soldering Chip mounting side 

Continued on the following page. ↗

EMIFIL® (Soldering and Mounting)

Continued from the preceding page.

Land Pattern
 + Solder Resist
 Land Pattern
 Solder Resist
 (in mm)

DLM11G
DLM2HG
DLP0NS
DLP11S
DLP2AD
DLP31S
DLP31D
DLW21S
DLW21H
DLW31S
DLW5AH
DLW5BS
DLW5BT

●Reflow and Flow

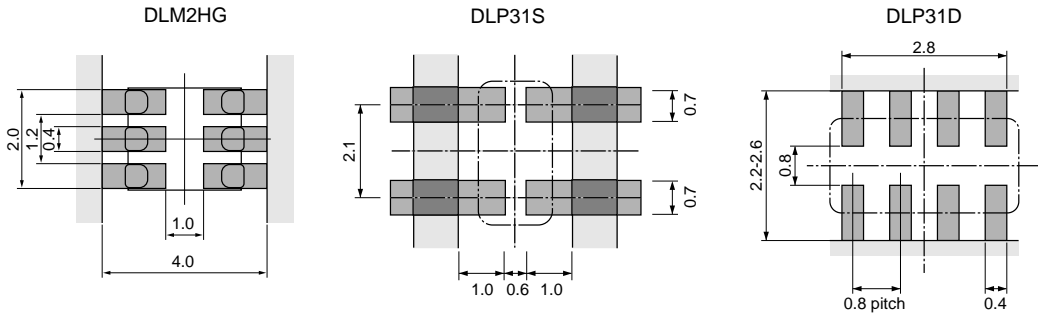

●Reflow Soldering



DLW21S/21H/31S

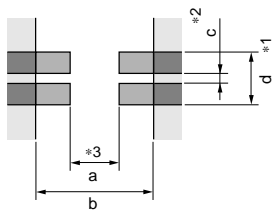

DLW5AH/5BS/5BT

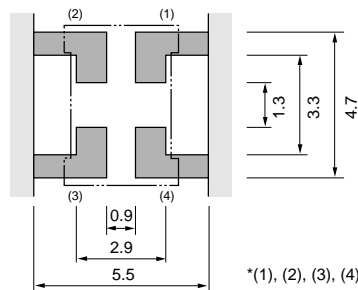

*(1), (2), (3), (4): Terminal Number

Series	a	b	c	d
DLW21S/H	0.8	2.6	0.4	1.2
DLW31S	1.6	3.7	0.4	1.6

- * 1: If the pattern is made with wider than 1.2mm (DLW21) / 1.6mm (DLW31S) it may result in components turning around, because melting speed is different. In the worst case, short circuit between lines may occur.
- * 2: If the pattern is made with less than 0.4mm, in the worst case, short circuit between lines may occur due to spread of soldering paste or mount placing accuracy.
- * 3: If the pattern is made with wider than 0.8mm (DLW21) / 1.6mm (DLW31S), the bending strength will be reduced. Do not use gild pattern; excess soldering heat may dissolve metal of a copper wire.

Continued on the following page. ↗

EMIFIL® (Soldering and Mounting)

Continued from the preceding page.

Land Pattern
 + Solder Resist
 Land Pattern
 Through Hole

BNX022
BNX033

- (1) A double-sided print board (or multilayer board) as shown in the left figure is designed, and please apply a soldering Cu electrode with a product electrode to a "Land Pattern", apply resist to a "Land Pattern + Solder Resist" at Cu electrode.
- (2) Please drop CG on a ground electrode on the back layer (the same also in a multilayer case) by the through hole. And a surface ground electrode layer may also take a large area as much as possible.
- (3) It is recommended to use a double-sided printed circuit board with BNX mounting on one side and the ground pattern on the other in order to maximize filtering performance, multiple feed through holes are required to maximize the BNX's connection to ground.
- (4) The ground pattern should be designed to be as large as possible to achieve maximum filtering performance.

2. Solder Paste Printing and Adhesive Application

When reflow soldering the chip EMI suppression filter, the printing must be conducted in accordance with the following cream solder printing conditions.

If too much solder is applied, the chip will be prone to damage by mechanical and thermal stress from the PCB and may crack.

Standard land dimensions should be used for resist and copper foil patterns.

When flow soldering the EMI suppression filter, apply the adhesive in accordance with the following conditions.

If too much adhesive is applied, then it may overflow into the land or termination areas and yield poor solderability. In contrast, if insufficient adhesive is applied, or if the adhesive is not sufficiently hardened, then the chip may become detached during flow soldering process.

(in mm)

Series	Solder Paste Printing	Adhesive Application
<p>BLM (Except BLM 15A_AN series)</p>	<ul style="list-style-type: none"> ● Ensure that solder is applied smoothly to a minimum height of 0.2mm to 0.3mm at the end surface of the part. ● Coat with solder paste to the following thickness: 50-80μm: BLM02 100-150μm: BLM03 100-200μm: BLM15/18/21/31/41 <div style="text-align: center;"> </div>	<p>Coating amount is illustrated in the following diagram.</p> <div style="text-align: right; margin-bottom: 5px;"> <p>a: 20-70μm b: 30-35μm c: 50-105μm</p> </div> <div style="text-align: center;"> </div>
<p>BLA</p>	<ul style="list-style-type: none"> ● Use Sn/Pb=60/40 or Sn-3.0Ag-0.5Cu solder for pattern printing. Use of Sn-Zn based solder will deteriorate performance of products. In case of using Sn-Zn based solder, please contact Murata in advance. ● Coat with solder paste to the following thickness: 100-150μm: BLA2A 150-200μm: BLA31 <div style="display: flex; justify-content: space-around; margin-top: 10px;"> <div style="text-align: center;"> <p>BLA31</p> </div> <div style="text-align: center;"> <p>BLA2A</p> </div> </div>	<p>BLA31 Series only Coating amount is illustrated in the following diagram.</p> <div style="text-align: right; margin-bottom: 5px;"> <p>a: 20-70μm b: 30-35μm c: 50-105μm</p> </div> <div style="text-align: center;"> </div>

Continued on the following page.

EMIFIL[®] (Soldering and Mounting)

Continued from the preceding page.

(in mm)

Series	Solder Paste Printing	Adhesive Application
<p>NFM NFR NFL</p>	<ul style="list-style-type: none"> ● Use Sn/Pb=60/40 or Sn-3.0Ag-0.5Cu solder for pattern printing. Use of Sn-Zn based solder will deteriorate performance of products. If using NFM series with Sn-Zn based solder, please contact Murata in advance. ● Coat with solder paste to the following thickness: 100-150μm: NFM18/21/3D/31P, NFR, NFL 150-200μm: NFM55P 100-200μm: NFM41 <div style="display: flex; justify-content: space-around;"> <div style="text-align: center;"> <p>NFM18C/18PC NFL18ST</p> </div> <div style="text-align: center;"> <p>NFL18SP</p> </div> <div style="text-align: center;"> <p>NFM21C/21P NFR21G/NFL21S</p> </div> </div> <div style="text-align: center; margin-top: 10px;"> <p>NFM18PS</p> </div> <div style="display: flex; justify-content: space-around; margin-top: 10px;"> <div style="text-align: center;"> <p>NFM3DC/3DP</p> </div> <div style="text-align: center;"> <p>NFM31P</p> </div> </div> <div style="display: flex; justify-content: space-around; margin-top: 10px;"> <div style="text-align: center;"> <p>NFM41C/41P</p> </div> <div style="text-align: center;"> <p>NFM55P</p> </div> </div>	<p>Apply 0.1mg for NFM41C/41P and 0.06mg for NFM3D/NFM31PC of bonding agent at each chip. Do not cover electrodes.</p> <div style="display: flex; justify-content: space-around; align-items: center;">   </div>

Continued on the following page. ↗

EMIFIL® (Soldering and Mounting)

Continued from the preceding page.

(in mm)

Series	Solder Paste Printing	Adhesive Application
<p>NFA</p>	<ul style="list-style-type: none"> ●Use Sn/Pb=60/40 or Sn-3.0Ag-0.5Cu solder for pattern printing. ●Coat with solder paste to the following thickness: 100-200μm: NFA31G/31C 100-150μm: NFA18S/21S <div style="display: flex; justify-content: space-around;"> <div style="text-align: center;"> <p>NFA31G/31C</p> </div> <div style="text-align: center;"> <p>NFA21S</p> </div> </div> <div style="text-align: center; margin-top: 10px;"> <p>NFA18S</p> </div>	
<p>NFW31S NFE31P</p>	<ul style="list-style-type: none"> ●Use Sn/Pb=60/40 or Sn-3.0Ag-0.5Cu solder for pattern printing. ●Coat with solder paste to the following thickness: 150-200μm 	<p>NFW31S Series Apply 0.2mg of bonding agent at each chip.</p>
<p>NFE61P</p>	<ul style="list-style-type: none"> ●Use Sn/Pb=60/40 or Sn-3.0Ag-0.5Cu solder for pattern printing. ●Coat with solder paste to the following thickness: 150-200μm 	<p>Apply 1.0mg of bonding agent at each chip.</p>

Continued on the following page. ↗

EMIFIL® (Soldering and Mounting)

Continued from the preceding page.

(in mm)

Series	Solder Paste Printing	Adhesive Application																																								
DLP DLW DLM	<ul style="list-style-type: none"> ● Use Sn/Pb=60/40 or Sn-3.0Ag-0.5Cu solder for pattern printing. Use of Sn-Zn based solder will deteriorate performance of products. If using DLP/DLM series with Sn-Zn based solder, please contact Murata in advance. ● Coat with solder paste to the following thickness: 100-150μm: DLW21S/21H/31S, DLP0NS/11S/2AD 150-200μm: DLP31D/31S, DLM2HG, DLW5AH/5BS/5BT <p>*Solderability is subject to reflow conditions and thermal conductivity. Please make sure that your product has been evaluated in view of your specifications with our product being mounted to your product.</p> <div style="display: flex; justify-content: space-around;"> <div style="text-align: center;"> <p>DLP0NS/11S/31S/DLM11G</p>  </div> <div style="text-align: center;"> <p>DLW21S/21H/31S</p>  </div> </div> <table border="1" style="width: 100%; border-collapse: collapse; margin-top: 10px;"> <thead> <tr> <th>Series</th> <th>a</th> <th>b</th> <th>c</th> <th>d</th> </tr> </thead> <tbody> <tr> <td>DLP0NS</td> <td>0.3</td> <td>0.3</td> <td>0.3</td> <td>0.5</td> </tr> <tr> <td>DLP11S</td> <td>0.7</td> <td>0.55</td> <td>0.3</td> <td>0.55</td> </tr> <tr> <td>DLP31S</td> <td>1.0</td> <td>0.6</td> <td>0.7</td> <td>2.1</td> </tr> <tr> <td>DLM11G</td> <td>0.5</td> <td>0.5</td> <td>0.4</td> <td>0.7</td> </tr> </tbody> </table> <div style="display: flex; justify-content: space-around; margin-top: 10px;"> <div style="text-align: center;"> <p>DLP2AD/31D</p>  </div> <div style="text-align: center;"> <table border="1" style="width: 100%; border-collapse: collapse;"> <thead> <tr> <th>Series</th> <th>a</th> <th>b</th> <th>c</th> <th>d</th> </tr> </thead> <tbody> <tr> <td>DLP2AD</td> <td>0.55</td> <td>0.4</td> <td>0.25</td> <td>0.5</td> </tr> <tr> <td>DLP31D</td> <td>1.0</td> <td>0.8</td> <td>0.4</td> <td>0.8</td> </tr> </tbody> </table> </div> </div> <div style="display: flex; justify-content: space-around; margin-top: 10px;"> <div style="text-align: center;"> <p>DLW5AH/5BS/5BT</p>  </div> <div style="text-align: center;"> <p>DLM2HG</p>  </div> </div>	Series	a	b	c	d	DLP0NS	0.3	0.3	0.3	0.5	DLP11S	0.7	0.55	0.3	0.55	DLP31S	1.0	0.6	0.7	2.1	DLM11G	0.5	0.5	0.4	0.7	Series	a	b	c	d	DLP2AD	0.55	0.4	0.25	0.5	DLP31D	1.0	0.8	0.4	0.8	<p>DLP31S/DLM2HG Apply 0.3mg of bonding agent at each chip.</p> <div style="display: flex; justify-content: space-around; margin-top: 20px;"> <div style="text-align: center;"> <p>DLP31D</p>  <p>Coating Position of Bonding Agent</p> </div> <div style="text-align: center;"> <p>DLP31S</p>  <p>Coating Position of Bonding Agent</p> </div> </div> <div style="text-align: center; margin-top: 20px;"> <p>DLM2HG</p>  <p>Coating Position of Bonding Agent</p> </div>
Series	a	b	c	d																																						
DLP0NS	0.3	0.3	0.3	0.5																																						
DLP11S	0.7	0.55	0.3	0.55																																						
DLP31S	1.0	0.6	0.7	2.1																																						
DLM11G	0.5	0.5	0.4	0.7																																						
Series	a	b	c	d																																						
DLP2AD	0.55	0.4	0.25	0.5																																						
DLP31D	1.0	0.8	0.4	0.8																																						

Continued on the following page. ↗

EMIFIL® (Soldering and Mounting)

Continued from the preceding page.

Series	Solder Paste Printing	Adhesive Application
BNX022 BNX023	<ul style="list-style-type: none"> ● Use Sn/Pb=60/40 or Sn-3.0Ag-0.5Cu solder for pattern printing. ● Coat with solder paste to the following thickness: 150-200μm <div style="text-align: center;"> </div>	

3. Standard Soldering Conditions

(1) Soldering Methods

- Use flow and reflow soldering methods only.
- Use standard soldering conditions when soldering chip EMI suppression filters.
- In cases where several different parts are soldered, each having different soldering conditions, use those conditions requiring the least heat and minimum time.

Solder: H60A H63A solder (JIS Z 3238)

- In case of lead-free solder, use Sn-3.0Ag-0.5Cu solder. Use of Sn-Zn based solder will deteriorate performance of products.
- If using BLA/NFM/DLP/DLM series with Sn-Zn based solder, please contact Murata in advance.

Flux:

- Use Rosin-based flux.
 - In case of DLW21/31 series, use Rosin-based flux with converting chlorine content of 0.06 to 0.1wt%.
 - In case of using RA type solder, products should be cleaned completely with no residual flux.
- Do not use strong acidic flux (with chlorine content exceeding 0.20wt%)
- Do not use water-soluble flux.

For additional mounting methods, please contact Murata.

(2) Soldering profile

- Flow Soldering profile
(Eutectic solder, Sn-3.0Ag-0.5Cu solder)

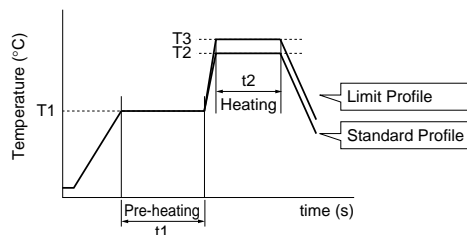

Series	Pre-heating		Standard Profile			Limit Profile		
	Temp. (T1)	Time. (t1)	Heating		Cycle of flow	Heating		Cycle of flow
			Temp. (T2)	Time. (t2)		Temp. (T3)	Time. (t2)	
BLM (Except BLM02/03/15/18G) BLA31 NFM3DC/3DP/31PC NFM41C/41P NFE61P DLM2HG DLP31D/31S	150°C	60s min.	250°C	4 to 6s	2 times max.	265±3°C	5s max.	2 times max.
NFW31S	150°C	60s min.	250°C	4 to 6s	2 times max.	265±3°C	5s max.	1 times

Continued on the following page.

EMIFIL® (Soldering and Mounting)

Continued from the preceding page.

●Reflow Soldering profile

①Soldering profile for Lead-free solder (Sn-3.0Ag-0.5Cu)



Series	Standard Profile				Limit Profile			
	Heating		Peak temperature (T2)	Cycle of reflow	Heating		Peak temperature (T4)	Cycle of reflow
	Temp. (T1)	Time. (t1)			Temp. (T3)	Time. (t2)		
BLM, BLA NFA, NFE NFL, NFM (Except NFM55P) NFR, DLM DLP DLW21/31	220°C min.	30 to 60s	245±3°C	2 times max.	230°C min.	60s max.	260°C/10s	2 times max.
DLW5A/5B	220°C min.	30 to 60s	250±3°C	2 times max.	230°C min.	60s max.	260°C/10s	2 times max.
NFW31S, NFM55P	220°C min.	30 to 60s	245±3°C	2 times max.	230°C min.	60s max.	260°C/10s	1 times
BNX022/023	220°C min.	30 to 60s	250±3°C	2 times max.	230°C min.	60s max.	260°C/10s	2 times max.

②Soldering profile for Eutectic solder (Limit profile: refer to ①)

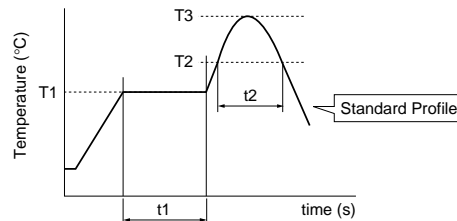

Series	Pre-heating		Standard Profile			
	Temp. (T1)	Time. (t1)	Heating		Peak temperature (T3)	Cycle of reflow
			Temp. (T2)	Time. (t2)		
BLM, BLA NFA, NFE NFL, NFM NFR, NFW DLM, DLP DLW, BNX022/023	150°C	60s min.	183°C min.	60s max.	230°C	2 times max.

(3) Reworking with Solder Iron

The following conditions must be strictly followed when using a soldering iron.

Pre-heating: 150°C 60s min.*1

*1 NFM55P: 100°C/60s+200°C/60s

Soldering iron power output: 30W max.*2

*2 BNX022/023: 100W max.

Temperature of soldering iron tip / Soldering time: 350°C max./3s max.*3

*3 NFE31PT152Z1E9: 280°C max./10s max.

BNX022/023: 450°C max./5s max./1 times

Do not allow the tip of the soldering iron to directly contact the chip.

For additional methods of reworking with a soldering iron, please contact Murata engineering.

Continued on the following page.

EMIFIL® (Soldering and Mounting)

Continued from the preceding page.

4. Cleaning

Following conditions should be observed when cleaning chip EMI filter.

- (1) Cleaning Temperature: 60°C max. (40°C max. for alcohol type cleaner)
- (2) Ultrasonic
Output: 20W/liter max.
Duration: 5 minutes max.
Frequency: 28 to 40kHz
- (3) Cleaning agent
The following list of cleaning agents have been tested on the individual components. Evaluation of final assembly should be completed prior to production.

Do not clean DLW21S/31S/5AH/5BS/5BT/BNX022/023 series.

Before cleaning, please contact Murata engineering.

- (a) Alcohol cleaning agent
Isopropyl alcohol (IPA)
 - (b) Aqueous cleaning agent
Pine Alpha ST-100S
- (4) Ensure that flux residue is completely removed.
Component should be thoroughly dried after aqueous agent has been removed with deionized water.
 - (5) Some products may become slightly whitened.
However, product performance or usage is not affected.
For additional cleaning methods, please contact Murata engineering.

5. Mounting of BLM15A_AN Series

BLM15A_AN is series for wire bonding mounting.

(1) Die bonding mounting

(a) Dimension of standard metal mask

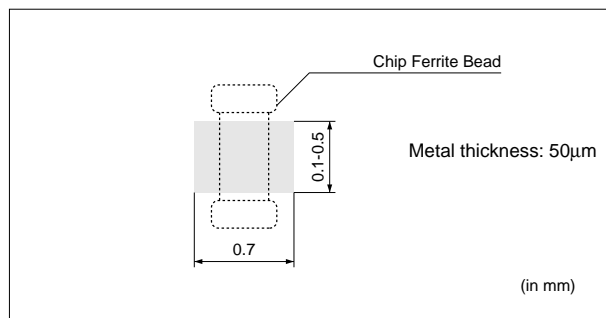

(b) Die bonding agent

- Use adhesive for die bonding for which the curing temperature is 200°C or less.

(c) Notice

- Use a flat surface of substrate for bonding mounting.
Slant mounting of product may affect the wire bonding.
- Adhesive for die bonding may affect the mounting reliability in wire bonding.
Make sure of the mounting reliability with the adhesive to be used in advance.

Lead Type EMIFIL® (Soldering and Mounting)

1. Mounting Hole

Mounting holes should be designed as specified below.

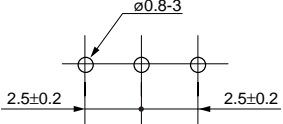
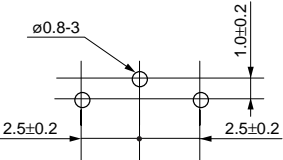
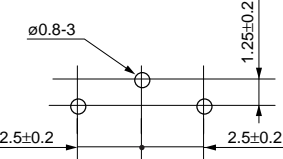
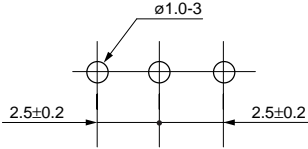
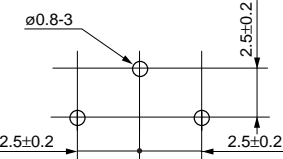
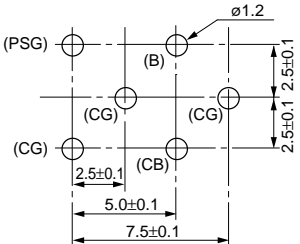
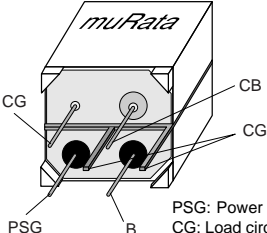
Part number	Bulk type (in mm)	Taping type (in mm)
DSN6 DSS6 VFR3V VFS6V		
DSN9 DSN9H		
DST9 DST9H		
DSS9 DSS9H VFS9V		
BNX00□/01□	<p>Component Side</p> 	<p>TERMINAL LAYOUT (Bottom figure)</p>  <p>PSG: Power supply ground CG: Load circuit ground CB: Load circuit + Bias</p>

Continued on the following page. ↗

Lead Type EMIFIL® (Soldering and Mounting)

Continued from the preceding page.

2. Using The Block Type EMIFIL® Effectively

(1) How to use effectively

This product effectively prevents undesired radiation and external noise from going out / entering the circuit by grounding the high frequency components which cause noise problems. Therefore, grounding conditions may affect the performance of the filter and attention should be paid to the following for effective use.

- Design maximized grounding area in the P.C. board, and grounding pattern for all the grounding terminals of the product to be connected. (Please follow the specified recommendations.)
- Minimize the distance between ground of the P.C. board and the ground plate of the product. (Recommend using the through hole connection between grounding area both of component side and bottom side.)
- Insert the terminals into the holes on P.C. board completely.
- Don't connect PSG terminal with CG terminal directly. (See the item 1. Terminal Layout)

(2) Self-heating

Though this product has a large rated current, localized selfheating may be caused depending on soldering conditions. To avoid this, attention should be paid to the following:

- Use P.C. board with our recommendation on hole diameter / land pattern dimensions, mentioned in the right hand drawing, especially for 4 terminals which pass current.
- Solder the terminals to the P.C. board with soldercover area at least 90%. Otherwise, excess self-heating at connection between terminals and P.C. board may lead to smoke and / or fire of the product even when operating at rated current.
- After installing this product in your product, please make sure the self-heating is within the rated current recommended.

P. C. BOARD PATTERNS

Use a bilateral P.C. board. Insert the BNX into the P.C.board until the root of the terminal is secured, then solder.

(1) COMPONENT SIDE VIEW (2) BOTTOM VIEW

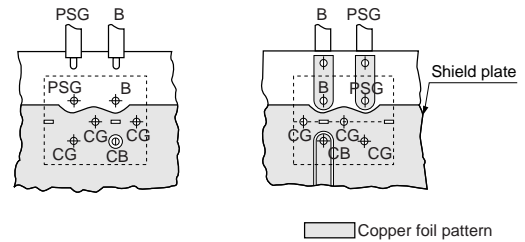

Recommended land pattern

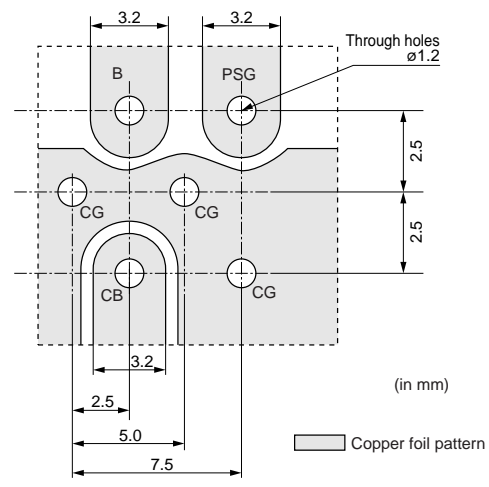

Continued on the following page. ↗

Lead Type EMIFIL® (Soldering and Mounting)

☒ Continued from the preceding page.

3. Using EMIGUARD® effectively

- (1) Terminal (with mark) should be properly connected to the line of incoming electrostatic surge. (There is polarity.) Otherwise, no effect in ESD suppression can be expected (VFR3V).
- (2) Products should be used at rated voltage or less and rated current or less.
- (3) Products should not be applied for the absorption of surges which have large energy (ex. induced lightning surges, switching surges) because it is designed for the absorption of electrostatic surges (VFR3V).
- (4) Electrostatic test should be done on the following conditions (VFR3V).

$$n \cdot [C / R \cdot V^2]^2 < 8.0 \times 10^5$$
 - n: Times applied
 - C: Charging Capacitance (pF)
 - V: Testing Voltage (kV)
 - R: Charging Resistance (Ω)

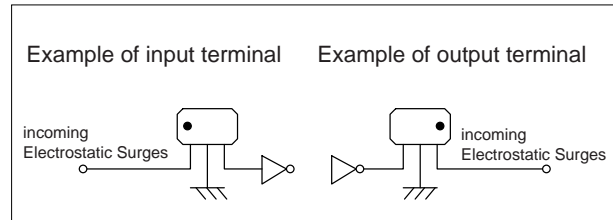

4. Soldering

- (1) Solder: H60A, H63A solder (JIS Z 3238)
In case of lead-free solder, use Sn-3.0Ag-0.5Cu solder.
- (2) Use Rosin-based flux. Do not use strong acidic flux with halide content exceeding 0.2wt% (chlorine conversion value).
- (3) Products and the leads should not be subjected to any mechanical stress during the soldering process, or while subjected to the equivalent high temperatures.
- (4) Standard flow soldering profile

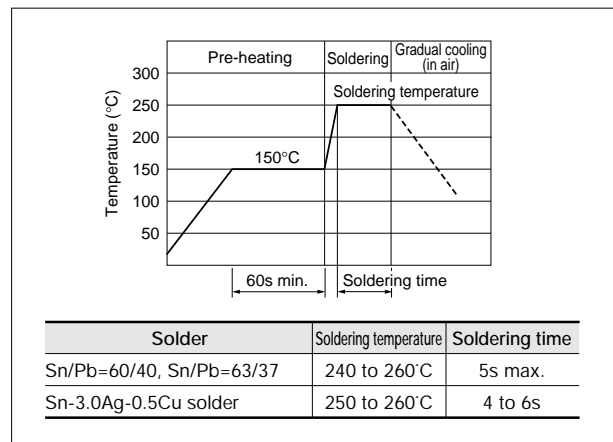

5. Cleaning Conditions

Do not clean VFR3V, PLT09H and VFS6V series.
Clean other parts in the following conditions.

- (1) Cleaning temperature should be limited to 60°C max. (40°C max for alcohol type cleaner).
- (2) Ultrasonic cleaning should comply with the following conditions, avoiding the resonance phenomenon at the mounted products and P.C.B.
Power: 20 W / l max. Frequency: 28 to 40kHz
Time: 5 min. max.
- (3) Cleaner
 - (a) Alcohol type cleaner
Isopropyl alcohol (IPA)

(b) Aqueous agent (PLT series cannot be cleaned)
PINE ALPHA ST-100S

- (4) There should be no residual flux or residual cleaner left after cleaning.
In the case of using aqueous agent, products should be dried completely after rinsing with de-ionized water in order to remove the cleaner.
- (5) The surface of products may become dirty after cleaning, but there is no deterioration on mechanical, electrical characteristics and reliability.
- (6) Other cleaning: Please contact us.

Chip EMIFIL® Packaging

Minimum Quantity and Dimensions of 8mm Width Paper / Embossed Tape

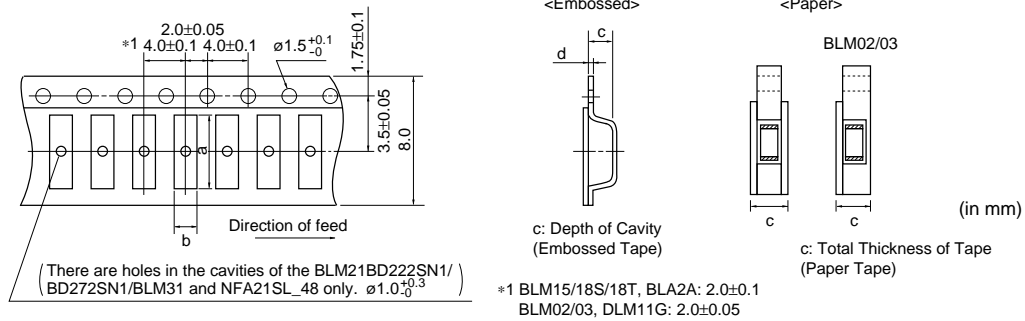

Part Number	Cavity Size (in mm)				Minimum Qty. (pcs.)				Bulk
					ø180mm reel		ø330mm reel		
	a	b	c	d	Paper Tape	Embossed Tape	Paper Tape	Embossed Tape	
BLM02	0.45	0.25	0.40 max.	-	20000	-	-	-	1000
BLM03	0.70	0.40	0.55 max.	-	15000	-	50000	-	1000
BLM15	1.15	0.65	0.8 max.	-	10000	-	50000	-	1000
BLM18	1.85	1.05	1.1 max.	-	4000	-	10000	-	1000
BLM18EG/KG_TN	1.85	1.05	0.85 max.	-	4000	-	10000	-	1000
BLM18EG/KG_SN			1.1 max.						
BLM18S	1.85	1.05	0.90 max.	-	10000	-	30000	-	1000
BLM18T	1.85	1.05	0.90 max.	-	10000	-	-	-	1000
BLM21	2.25	1.45	1.1 max.	-	4000	-	10000	-	1000
BLM31	3.5	1.9	1.3	0.2	-	3000	-	10000	1000
BLM21BD222SN1/272SN1	2.25	1.45	1.3	0.2	-	3000	-	10000	1000
BLA2A	2.2	1.2	0.8 max.	-	10000	-	50000	-	1000
BLA31	3.4	1.8	1.1 max.	-	4000	-	10000	-	1000
NFM18C/ NFM18PC (Except 105R/225B1A)/ NFM18PS	1.85	1.05	0.9 max.	-	4000	-	-	-	500
NFM18PC105R/225B1A			1.1 max.						
NFL18SP	1.85	1.05	0.9 max.	-	4000	-	-	-	1000
NFL18ST			1.1 max.						
NFL21SP	2.3	1.55	1.1 max.	-	4000	-	-	-	500
NFM21	2.3	1.55	1.1 max.	-	4000	-	-	-	500
NFM3DC/3DP	3.4	1.4	0.85	0.2	-	4000	-	-	500
NFM31P	3.5	1.9	1.5	0.25	-	3000	-	-	500
NFA18S	1.8	1.0	0.7	0.25	-	4000	-	-	1000
NFA21SL_45	2.30	1.55	0.7	0.25	-	4000	-	-	1000
NFA21SL_48	2.25	1.45	1.05	0.25	-	4000	-	-	1000
NFA31G/31C	3.5	2.0	1.1 max.	-	4000	-	-	-	100
NFE31P	3.6	1.8	1.85	0.2	-	2000	-	8000	500
NFR21G	2.3	1.55	0.7	0.25	-	4000	-	-	500
NFW31S	3.6	1.9	2.0	0.2	-	2000	-	7500	-
DLM11G	1.45	1.2	0.8 max.	-	10000	-	-	-	1000
DLM2HG	2.75	2.25	1.3	0.25	-	3000	-	-	1000
DLP0NS	0.95	0.75	0.55	0.25	-	5000	-	-	500
DLP11S	1.4	1.2	0.98	0.25	-	3000	-	-	500
DLP2AD	2.2	1.2	0.98	0.25	-	3000	-	-	500
DLP31D/31S	3.5	1.9	1.3	0.25	-	3000	-	-	500
DLW21S	2.25	1.45	1.4	0.3	-	2000	-	-	500
DLW21H	2.3	1.55	1.1	0.25	-	3000	-	-	500
DLW31S	3.6	2.0	2.1	0.3	-	2000	-	-	500

• Please contact us for BLM15/18 in bulk case.

Continued on the following page.

Chip EMIFIL® Packaging

Continued from the preceding page.

Minimum Quantity and Dimensions of 12mm Width Embossed Tape



Part Number	Cavity Size			Minimum Qty. (pcs.)		
	a	b	c	ø180mm reel	ø330mm reel	Bulk
BLM41	4.8	1.9	1.75	2500	8000	1000
NFM41	4.8	1.8	1.1	4000	-	500
NFE61	7.2	1.9	1.75	2500	8000	500



Part Number	Cavity Size			Minimum Qty. (pcs.)		
	a	b	c	ø180mm reel	ø330mm reel	Bulk
DLW5AH	5.4	4.1	4.4	400	1500	100
DLW5BS	5.5	5.4	4.7	400	1500	100
DLW5BT	5.5	5.4	2.7	700	2500	100



Part Number	Cavity Size			Minimum Qty. (pcs.)		
	a	b	c	ø180mm reel	ø330mm reel	Bulk
NFM55P	6.0	5.3	2.5	500	-	100

(in mm)

Minimum Quantity and Dimensions of 24mm Width Embossed Tape

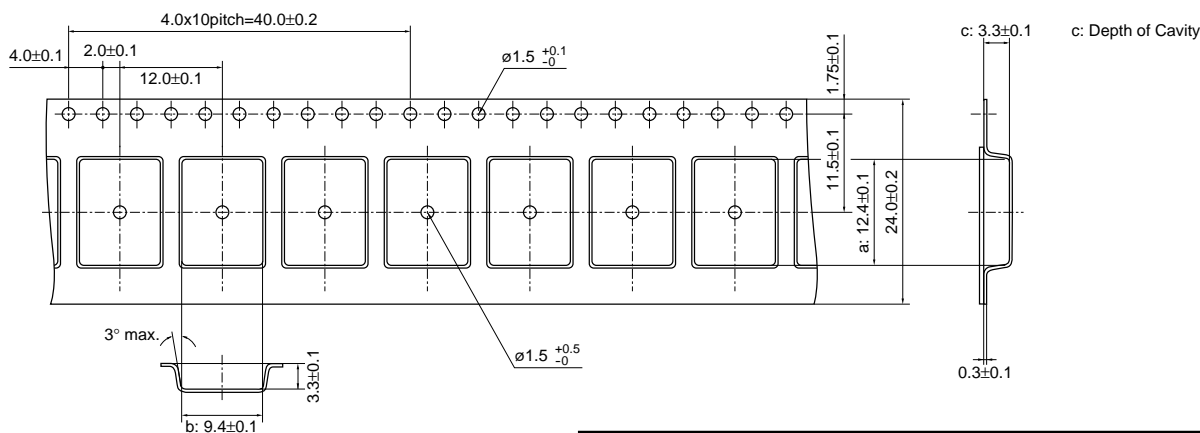

Part Number	Cavity Size			Minimum Qty. (pcs.)		
	a	b	c	ø180mm reel	ø330mm reel	Bulk
BNX022/023	12.4	9.4	3.3	400	1500	100

(in mm)

Ferrite Beads Inductors Packaging

Minimum Quantity (Pcs.)

Series	Bulk	Ammo Pack	ø320mm Paper reel
BL01RN	500	1000	2000
BL02RN	500	1500	—
BL03RN	1000	2000	—

Taping Dimensions

BL01RN_J

BL01RN_A

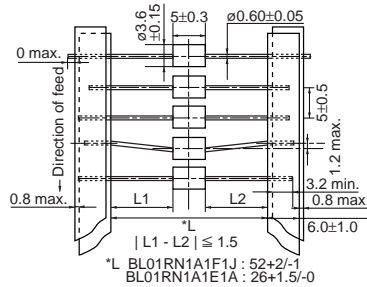

BL02RN1R2□1A

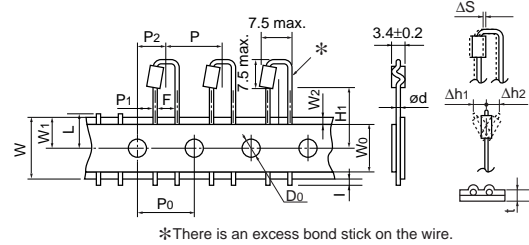

BL02RN1R3N1A

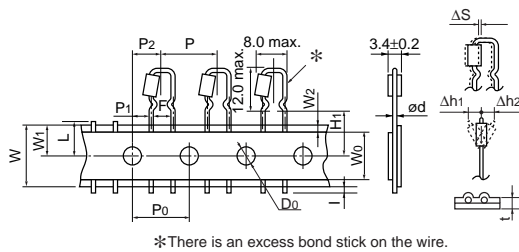

BL02RN2R1□1A

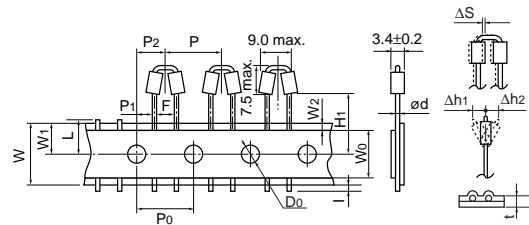

BL02RN2R3N1A

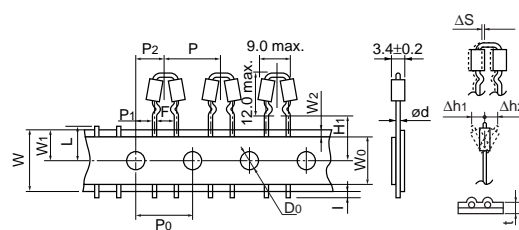

BL03RN2R1□1A

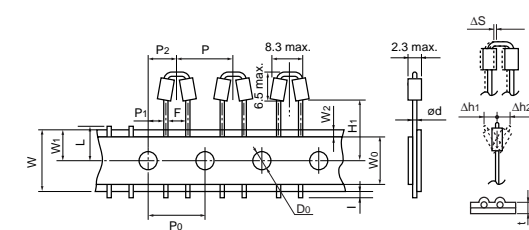

Description	Symbol	Dimension (mm)	Remarks	
Pitch of component	P	12.7	Product inclination ΔS determines tolerance	
Pitch of sprocket hole	P0	12.7±0.2		
Lead spacing	F	5.0 ^{+0.8} _{-0.2}		
Hole center to lead	P1	3.85±0.7		
Hole center to component center	P2	6.35±1.3	Tape deviation in feeding direction	
Offset of bead	ΔS	±1.0	Include the offset caused by lead bend	
Carrier tape width	W	18.0±0.5		
Position of sprocket hole	W1	9.0 ⁺⁰ _{-0.5}	Tape with deviation	
Lead length between sprocket hole and forming position	H1	Lead Length Number : N	16.5±0.5	BL02, BL03
		Lead Length Number : Q	20.0±0.5	BL02RN1R2/2R1, BL03
		Lead Length Number : P	18.5±0.5	BL02, BL03
Protruding length	I	+0.5 to -1.0		
Diameter of sprocket hole	D0	ø4.0±0.1		
Lead Diameter	ød	ø0.60		
Total tape thickness	t	0.7±0.2	Including bonding tape thickness	
Deviation across tape, Deviation across tape rear	Δh1, Δh2	1.0 max.		
Cutting position of failure	L	11.0 ⁺⁰ _{-1.0}		
Hold down tape width	W0	12.0±0.5		
Hold down tape position	W2	1.5±1.5		

(in mm)

Disc Type EMIFIL[®] and EMIGUARD[®] Packaging

Minimum Quantity

Part Number	Minimum Order Quantity (order in sets only) (Pcs.)		
	Ammo Pack	ø320mm Paper reel	Bulk (Bag)
VFR3V Series	2000	—	250
DS□6/VFS6V Series	2000	—	250 Q55/T51 500 Q54/Q56/T41
DSN9/9H Series	2000	—	250 Q55 500 Q54/Q56
DST9 Series	1000	—	200 Q55 250 Q50/Q52
DSS9 Series	—	800	200 Q55 500 Q54/Q56
VFS9V Series	—	800	200

Lead Type Code

Lead Type code		Lead length (H)
Straight Type	Incrimp Type	
Q91	-	20.0±1.0mm
Q92	U21	16.5±1.0mm
Q93	U31	18.5±1.0mm

Taping Dimensions

DSN6_Q91/Q92/Q93

DSN9_Q91/Q92/Q93

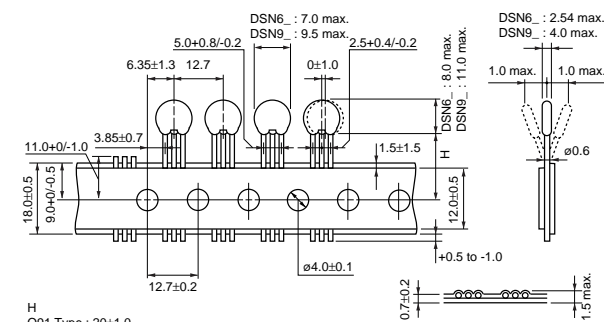

H
Q91 Type : 20±1.0
Q92 Type : 16.5±1.0
Q93 Type : 18.5±1.0

DSS6_Q91/Q92/Q93

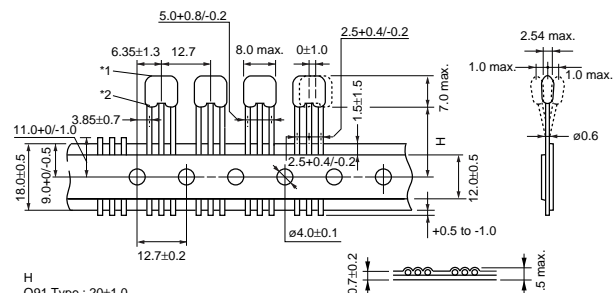

H
Q91 Type : 20±1.0
Q92 Type : 16.5±1.0
Q93 Type : 18.5±1.0
*1 Bottom of dielectric may be exposed.
*2 If a hole is on the top of the ferrite bead, the bead should not be exposed.

DST9_Q92/Q93

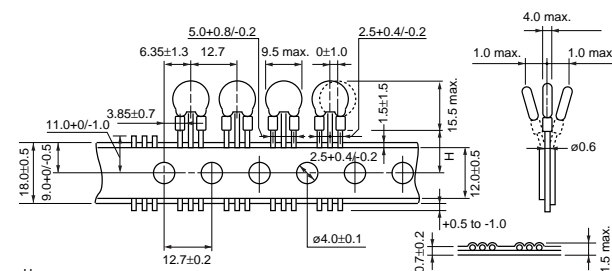

H
Q92 Type : 16.5±1.0
Q93 Type : 18.5±1.0

DSS6_U21/U31

VFS6V_U31

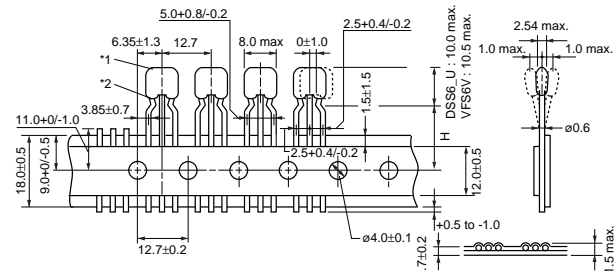

H
U21 Type : 16.5±1.0
U31 Type : 18.5±1.0
*1 Bottom of dielectric may be exposed.
*2 If a hole is on the top of the ferrite bead, the bead should not be exposed.

DSS9_Q91/Q92/Q93

VFS9V_Q91/Q92/Q93

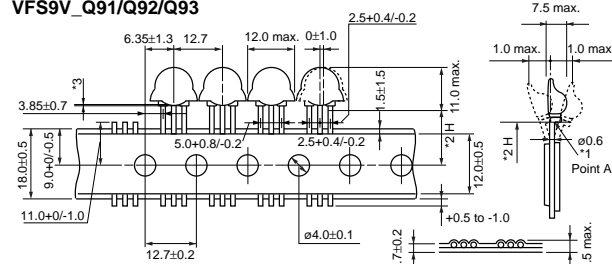

H
Q91 Type : 20±1.0
Q92 Type : 16.5±1.0
Q93 Type : 18.5±1.0
*1 Coating extending on leads does not exceed the start of bend. (Point A)
Exposed electrodes are covered with solder.
*2 H: to be measured from the forming point A.
*3 The deviation between two ferrite beads should be less than 1.2mm.

VFR3V_U31

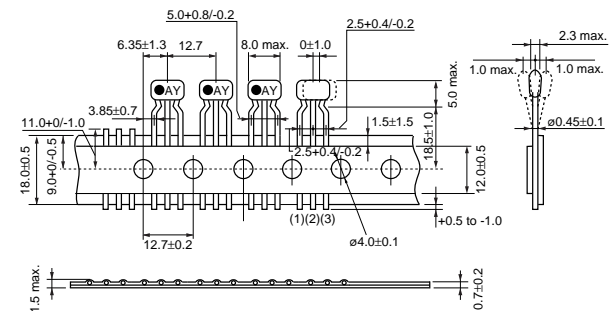

(in mm)

Chip EMI Suppression Filter Design Kits



●EKEMBL03D (Chip Ferrite Beads 01005 Size / 0201 Size)

No.	Part Number	Quantity (pcs.)	Impedance typ. (at 100MHz, 20 degrees C)	Rated Current (mA)	DC Resistance (Ω) max.
1	BLM02AG100SN1	10	10Ω (Typ.)	500	0.1
2	BLM02AG700SN1	10	70Ω±25%	250	0.5
3	BLM02AG121SN1	10	120Ω±25%	200	0.8
4	BLM03AG100SN1	10	10Ω (Typ.)	500	0.1
5	BLM03AG700SN1	10	70Ω (Typ.)	200	0.4
6	BLM03AG800SN1	10	80Ω±25%	200	0.4
7	BLM03AG121SN1	10	120Ω±25%	200	0.5
8	BLM03AG241SN1	10	240Ω±25%	200	0.8
9	BLM03AG601SN1	10	600Ω±25%	100	1.5
10	BLM03AG102SN1	10	1000Ω±25%	100	2.5
11	BLM03BB100SN1	10	10Ω±25%	300	0.4
12	BLM03BB220SN1	10	22Ω±25%	200	0.5
13	BLM03BB470SN1	10	47Ω±25%	200	0.7
14	BLM03BB750SN1	10	75Ω±25%	200	1.0
15	BLM03BB121SN1	10	120Ω±25%	100	1.5
16	BLM03BD750SN1	10	75Ω±25%	300	0.4
17	BLM03BD121SN1	10	120Ω±25%	250	0.5
18	BLM03BD241SN1	10	240Ω±25%	200	0.8
19	BLM03PG220SN1	10	22Ω±25%	900	0.065
20	BLM03PG330SN1	10	33Ω±25%	750	0.090

●EKEMBL15J (Chip Ferrite Beads 0402 Size)

No.	Part Number	Quantity (pcs.)	Impedance typ. (at 100MHz, 20 degrees C)	Rated Current (mA)	DC Resistance (Ω) max.
1	BLM15AG100SN1	10	10Ω (Typ.)	1000	0.05
2	BLM15AG700SN1	10	70Ω (Typ.)	500	0.15
3	BLM15AG121SN1	10	120Ω±25%	500	0.25
4	BLM15AG221SN1	10	220Ω±25%	300	0.35
5	BLM15AG601SN1	10	600Ω±25%	300	0.60
6	BLM15AG102SN1	10	1000Ω±25%	200	1.00
7	BLM15BA050SN1	10	5Ω±25%	300	0.10
8	BLM15BA100SN1	10	10Ω±25%	300	0.20
9	BLM15BA220SN1	10	22Ω±25%	300	0.30
10	BLM15BA330SN1	10	33Ω±25%	300	0.40
11	BLM15BA470SN1	10	47Ω±25%	200	0.60
12	BLM15BA750SN1	10	75Ω±25%	200	0.80
13	BLM15BB050SN1	10	5Ω±25%	500	0.08
14	BLM15BB100SN1	10	10Ω±25%	300	0.10
15	BLM15BB220SN1	10	22Ω±25%	300	0.20

Continued on the following page.

Chip EMI Suppression Filter Design Kits

Continued from the preceding page.

No.	Part Number	Quantity (pcs.)	Impedance typ. (at 100MHz, 20 degrees C)	Rated Current (mA)	DC Resistance (Ω) max.
16	BLM15BB470SN1	10	47Ω±25%	300	0.35
17	BLM15BB750SN1	10	75Ω±25%	300	0.40
18	BLM15BB121SN1	10	120Ω±25%	300	0.55
19	BLM15BB221SN1	10	220Ω±25%	200	0.80
20	BLM15BD750SN1	10	75Ω±25%	300	0.20
21	BLM15BD121SN1	10	120Ω±25%	300	0.30
22	BLM15BD221SN1	10	220Ω±25%	300	0.40
23	BLM15BD471SN1	10	470Ω±25%	200	0.60
24	BLM15BD601SN1	10	600Ω±25%	200	0.65
25	BLM15BD102SN1	10	1000Ω±25%	200	0.90
26	BLM15BD182SN1	10	1800Ω±25%	100	1.40
27	BLM15HD601SN1	10	600Ω±25%	300	0.85
28	BLM15HD102SN1	10	1000Ω±25%	250	1.25
29	BLM15HD182SN1	10	1800Ω±25%	200	2.20
30	BLM15HG601SN1	10	600Ω±25%	300	0.70
31	BLM15HG102SN1	10	1000Ω±25%	250	1.10
32	BLM15HB121SN1	10	120Ω±25%	300	0.70
33	BLM15HB221SN1	10	220Ω±25%	250	1.00
34	BLM15EG121SN1	10	120Ω±25%	1500	0.095
35	BLM15EG221SN1	10	220Ω±25%	700	0.28
36	BLM15GG221SN1	10	220Ω±25%	300	0.70
37	BLM15GG471SN1	10	470Ω±25%	200	1.30
38	BLM15GA750SN1	10	75Ω±25%	200	1.30
39	BLM15PG100SN1	10	10Ω (Typ.)	1000	0.05
40	BLM15PD300SN1	10	30Ω±25%	2200	0.035
41	BLM15PD600SN1	10	60Ω±25%	1700	0.06
42	BLM15PD800SN1	10	80Ω±25%	1500	0.07
43	BLM15PD121SN1	10	120Ω±25%	1300	0.09

●EKEMBL18G (Chip Ferrite Beads 0603 Size)

No.	Part Number	Quantity (pcs.)	Impedance typ. (at 100MHz, 20 degrees C)	Rated Current (mA)	DC Resistance (Ω) max.
1	BLM18AG121SN1	10	120Ω±25%	500	0.18
2	BLM18AG151SN1	10	150Ω±25%	500	0.25
3	BLM18AG221SN1	10	220Ω±25%	500	0.25
4	BLM18AG331SN1	10	330Ω±25%	500	0.30
5	BLM18AG471SN1	10	470Ω±25%	500	0.35
6	BLM18AG601SN1	10	600Ω±25%	500	0.38
7	BLM18AG102SN1	10	1000Ω±25%	400	0.50
8	BLM18BA050SN1	10	5Ω±25%	500	0.20
9	BLM18BA100SN1	10	10Ω±25%	500	0.25
10	BLM18BA470SN1	10	47Ω±25%	300	0.55
11	BLM18BA750SN1	10	75Ω±25%	300	0.70
12	BLM18BA121SN1	10	120Ω±25%	200	0.90
13	BLM18BB050SN1	10	5Ω±25%	700	0.05
14	BLM18BB100SN1	10	10Ω±25%	700	0.10
15	BLM18BB220SN1	10	22Ω±25%	600	0.20
16	BLM18BB470SN1	10	47Ω±25%	550	0.25
17	BLM18BB600SN1	10	60Ω±25%	550	0.25
18	BLM18BB750SN1	10	75Ω±25%	500	0.30
19	BLM18BB121SN1	10	120Ω±25%	500	0.30
20	BLM18BB151SN1	10	150Ω±25%	450	0.37

Continued on the following page. 

Chip EMI Suppression Filter Design Kits

Continued from the preceding page.

No.	Part Number	Quantity (pcs.)	Impedance typ. (at 100MHz, 20 degrees C)	Rated Current (mA)	DC Resistance (Ω) max.
21	BLM18BB221SN1	10	220Ω±25%	450	0.45
22	BLM18BB331SN1	10	330Ω±25%	400	0.58
23	BLM18BB471SN1	10	470Ω±25%	300	0.85
24	BLM18BD470SN1	10	47Ω±25%	200	0.30
25	BLM18BD121SN1	10	120Ω±25%	200	0.40
26	BLM18BD151SN1	10	150Ω±25%	200	0.40
27	BLM18BD221SN1	10	220Ω±25%	200	0.45
28	BLM18BD331SN1	10	330Ω±25%	200	0.50
29	BLM18BD421SN1	10	420Ω±25%	200	0.55
30	BLM18BD471SN1	10	470Ω±25%	200	0.55
31	BLM18BD601SN1	10	600Ω±25%	200	0.65
32	BLM18BD102SN1	10	1000Ω±25%	100	0.85
33	BLM18BD152SN1	10	1500Ω±25%	50	1.20
34	BLM18BD182SN1	10	1800Ω±25%	50	1.50
35	BLM18BD222SN1	10	2200Ω±25%	50	1.50
36	BLM18BD252SN1	10	2500Ω±25%	50	1.50
37	BLM18PG300SN1	10	30Ω (Typ.)	1000	0.05
38	BLM18PG330SN1	10	33Ω±25%	3000	0.025
39	BLM18PG600SN1	10	60Ω (Typ.)	500	0.10
40	BLM18PG121SN1	10	120Ω±25%	2000	0.05
41	BLM18PG181SN1	10	180Ω±25%	1500	0.09
42	BLM18PG221SN1	10	220Ω±25%	1400	0.10
43	BLM18PG331SN1	10	330Ω±25%	1200	0.15
44	BLM18PG471SN1	10	470Ω±25%	1000	0.20
45	BLM18KG260TN1	10	26Ω±25%	6000	0.007
46	BLM18KG700TN1	10	70Ω±25%	3500	0.022
47	BLM18KG121TN1	10	120Ω±25%	3000	0.030
48	BLM18KG221SN1	10	220Ω±25%	2200	0.050
49	BLM18KG331SN1	10	330Ω±25%	1700	0.080
50	BLM18KG471SN1	10	470Ω±25%	1500	0.130
51	BLM18KG601SN1	10	600Ω±25%	1300	0.150
52	BLM18SG260TN1	10	26Ω±25%	6000	0.007
53	BLM18SG700TN1	10	70Ω±25%	4000	0.020
54	BLM18SG121TN1	10	120Ω±25%	3000	0.025
55	BLM18SG221TN1	10	220Ω±25%	2500	0.040
56	BLM18SG331TN1	10	330Ω±25%	1500	0.070
57	BLM18RK121SN1	10	120Ω±25%	200	0.25
58	BLM18RK471SN1	10	470Ω±25%	200	0.5
59	BLM18RK601SN1	10	600Ω±25%	200	0.6
60	BLM18RK102SN1	10	1000Ω±25%	200	0.8

●EKEMBL8GA (Chip Ferrite Beads 0603 Size / for High Frequency Type)

No.	Part Number	Quantity (pcs.)	Impedance (at 100MHz, 20 degrees C)	Impedance (at 1GHz, 20 degrees C)	Rated Current (mA)	DC Resistance (Ω) max.
1	BLM18HG471SN1	10	470Ω±25%	600Ω (Typ.)	200	0.85
2	BLM18HG601SN1	10	600Ω±25%	700Ω (Typ.)	200	1.00
3	BLM18HG102SN1	10	1000Ω±25%	1000Ω (Typ.)	100	1.60
4	BLM18HB121SN1	10	120Ω±25%	500Ω±40%	200	0.50
5	BLM18HB221SN1	10	220Ω±25%	1100Ω±40%	100	0.80
6	BLM18HB331SN1	10	330Ω±25%	1600Ω±40%	50	1.20
7	BLM18HD471SN1	10	470Ω±25%	1000Ω (Typ.)	100	1.20
8	BLM18HD601SN1	10	600Ω±25%	1200Ω (Typ.)	100	1.50

Continued on the following page. 

Chip EMI Suppression Filter Design Kits

Continued from the preceding page.

No.	Part Number	Quantity (pcs.)	Impedance (at 100MHz, 20 degrees C)	Impedance (at 1GHz, 20 degrees C)	Rated Current (mA)	DC Resistance (Ω) max.
9	BLM18HD102SN1	10	1000Ω±25%	1700Ω (Typ.)	50	1.80
10	BLM18HE601SN1	10	600Ω±25%	600Ω (Typ.)	800	0.25
11	BLM18HE102SN1	10	1000Ω±25%	1000Ω (Typ.)	600	0.35
12	BLM18HE152SN1	10	1500Ω±25%	1500Ω (Typ.)	500	0.50
13	BLM18HK331SN1	10	330Ω±25%	400Ω (Typ.)	200	0.50
14	BLM18HK471SN1	10	470Ω±25%	600Ω (Typ.)	200	0.70
15	BLM18HK601SN1	10	600Ω±25%	700Ω (Typ.)	100	0.90
16	BLM18HK102SN1	10	1000Ω±25%	1200Ω (Typ.)	50	1.50
17	BLM18EG101TN1	10	100Ω±25%	140Ω (Typ.)	2000	0.045
18	BLM18EG121SN1	10	120Ω±25%	145Ω (Typ.)	2000	0.04
19	BLM18EG221TN1	10	220Ω±25%	300Ω (Typ.)	1000	0.15
20	BLM18EG221SN1	10	220Ω±25%	260Ω (Typ.)	2000	0.05
21	BLM18EG331TN1	10	330Ω±25%	450Ω (Typ.)	500	0.21
22	BLM18EG391TN1	10	390Ω±25%	520Ω (Typ.)	500	0.30
23	BLM18EG471SN1	10	470Ω±25%	550Ω (Typ.)	500	0.21
24	BLM18EG601SN1	10	600Ω±25%	700Ω (Typ.)	500	0.35
25	BLM18GG471SN1	10	470Ω±25%	1800Ω±30%	200	1.30

●EKEMBL21D (Chip Ferrite Beads 0805 Size / for Large-current P Type)

No.	Part Number	Quantity (pcs.)	Impedance typ. (at 100MHz, 20 degrees C)	Rated Current (mA)	DC Resistance (Ω) max.
1	BLM21AG121SN1	10	120Ω±25%	200	0.15
2	BLM21AG151SN1	10	150Ω±25%	200	0.15
3	BLM21AG221SN1	10	220Ω±25%	200	0.20
4	BLM21AG331SN1	10	330Ω±25%	200	0.25
5	BLM21AG471SN1	10	470Ω±25%	200	0.25
6	BLM21AG601SN1	10	600Ω±25%	200	0.30
7	BLM21AG102SN1	10	1000Ω±25%	200	0.45
8	BLM21BB050SN1	10	5Ω±25%	500	0.07
9	BLM21BB600SN1	10	60Ω±25%	200	0.20
10	BLM21BB750SN1	10	75Ω±25%	200	0.25
11	BLM21BB121SN1	10	120Ω±25%	200	0.25
12	BLM21BB221SN1	10	220Ω±25%	200	0.35
13	BLM21BB331SN1	10	330Ω±25%	200	0.40
14	BLM21BB471SN1	10	470Ω±25%	200	0.45
15	BLM21BD121SN1	10	120Ω±25%	200	0.25
16	BLM21BD221SN1	10	220Ω±25%	200	0.25
17	BLM21BD421SN1	10	420Ω±25%	200	0.30
18	BLM21BD471SN1	10	470Ω±25%	200	0.35
19	BLM21BD601SN1	10	600Ω±25%	200	0.35
20	BLM21BD102SN1	10	1000Ω±25%	200	0.40
21	BLM21BD152SN1	10	1500Ω±25%	200	0.45
22	BLM21BD182SN1	10	1800Ω±25%	200	0.50
23	BLM21BD222SN1	10	2250Ω (Typ.)	200	0.60
24	BLM21BD222TN1	10	2200Ω±25%	200	0.60
25	BLM21BD272SN1	10	2700Ω±25%	200	0.80
26	BLM21PG220SN1	10	22Ω±25%	6000	0.01
27	BLM21PG300SN1	10	30Ω (Typ.)	3000	0.015
28	BLM21PG600SN1	10	60Ω±25%	3000	0.025
29	BLM21PG221SN1	10	220Ω±25%	2000	0.050
30	BLM21PG331SN1	10	330Ω±25%	1500	0.09
31	BLM31PG330SN1	10	33Ω±25%	6000	0.01

Continued on the following page. ↗

Chip EMI Suppression Filter Design Kits

Continued from the preceding page.

No.	Part Number	Quantity (pcs.)	Impedance typ. (at 100MHz, 20 degrees C)	Rated Current (mA)	DC Resistance (Ω) max.
32	BLM31PG500SN1	10	50Ω (Typ.)	3000	0.025
33	BLM31PG121SN1	10	120Ω±25%	3000	0.025
34	BLM31PG391SN1	10	390Ω (Typ.)	2000	0.05
35	BLM31PG601SN1	10	600Ω (Typ.)	1500	0.09
36	BLM41PG600SN1	10	60Ω (Typ.)	6000	0.01
37	BLM41PG750SN1	10	75Ω (Typ.)	3000	0.025
38	BLM41PG181SN1	10	180Ω (Typ.)	3000	0.025
39	BLM41PG471SN1	10	470Ω (Typ.)	2000	0.05
40	BLM41PG102SN1	10	1000Ω (Typ.)	1500	0.09

●EKEMNFMCB (Chip EMIFIL® Capacitor Type for Signal Lines)

No.	Part Number	Quantity (pcs.)	Capacitance	Rated Voltage (Vdc)	Rated Current (mA)	Insulation Resistance (MΩ min.)
1	NFM18CC220U1C3	10	22pF±20%	16	400	1000
2	NFM18CC470U1C3	10	47pF±20%	16	400	1000
3	NFM18CC101R1C3	10	100pF±20%	16	500	1000
4	NFM18CC221R1C3	10	220pF±20%	16	500	1000
5	NFM18CC471R1C3	10	470pF±20%	16	500	1000
6	NFM18CC102R1C3	10	1000pF±20%	16	600	1000
7	NFM18CC222R1C3	10	2200pF±20%	16	700	1000
8	NFM18CC223R1C3	10	22000pF±20%	16	1000	1000
9	NFM21CC220U1H3	10	22pF±20%	50	700	1000
10	NFM21CC470U1H3	10	47pF±20%	50	700	1000
11	NFM21CC101U1H3	10	100pF±20%	50	700	1000
12	NFM21CC221R1H3	10	220pF±20%	50	700	1000
13	NFM21CC471R1H3	10	470pF±20%	50	1000	1000
14	NFM21CC102R1H3	10	1000pF±20%	50	1000	1000
15	NFM21CC222R1H3	10	2200pF±20%	50	1000	1000
16	NFM21CC223R1H3	10	22000pF±20%	50	2000	1000

●EKEMFA31D (Chip EMIFIL® Capacitor Array Type/ RC Combined Array Type)

No.	Part Number	Quantity (pcs.)	Capacitance	Rated Voltage (Vdc)	Rated Current (mA)	Insulation Resistance (MΩ min.)
1	NFA31CC220S1E4	10	22pF±20%	25	200	1000
2	NFA31CC470S1E4	10	47pF±20%	25	200	1000
3	NFA31CC101S1E4	10	100pF±20%	25	200	1000
4	NFA31CC221S1E4	10	220pF±20%	25	200	1000
5	NFA31CC471R1E4	10	470pF±20%	25	200	1000
6	NFA31CC102R1E4	10	1000pF±20%	25	200	1000
7	NFA31CC222R1E4	10	2200pF±20%	25	200	1000
8	NFA31CC223R1C4	10	22000pF±20%	16	200	1000
9	NFA31GD1006R84	10	10pF±20%	6	50	1000
10	NFA31GD1004704	10	10pF±20%	6	20	1000
11	NFA31GD1001014	10	10pF±20%	6	15	1000
12	NFA31GD4706R84	10	47pF±20%	6	50	1000
13	NFA31GD4703304	10	47pF±20%	6	20	1000
14	NFA31GD4704704	10	47pF±20%	6	20	1000
15	NFA31GD4701014	10	47pF±20%	6	15	1000
16	NFA31GD1016R84	10	100pF±20%	6	50	1000
17	NFA31GD1014704	10	100pF±20%	6	20	1000

Continued on the following page. 

Chip EMI Suppression Filter Design Kits

Continued from the preceding page.

No.	Part Number	Quantity (pcs.)	Capacitance	Rated Voltage (Vdc)	Rated Current (mA)	Insulation Resistance (MΩ min.)
18	NFA31GD1011014	10	100pF±20%	6	15	1000

●EKEMFL18E (Chip EMIFIL® LC Combined Type)

No.	Part Number	Quantity (pcs.)	Cut-off Frequency	Rated Voltage (Vdc)	Rated Current (mA)	Insulation Resistance (MΩ min.)	DC Resistance (Ω) max.
1	NFL18ST207X1C3	10	200MHz	16	150	1000	3.5
2	NFL18ST307X1C3	10	300MHz	16	200	1000	1.8
3	NFL18ST507X1C3	10	500MHz	16	200	1000	1.5
4	NFL18SP157X1A3	10	150MHz	10	100	1000	3.0
5	NFL18SP207X1A3	10	200MHz	10	100	1000	3.0
6	NFL18SP307X1A3	10	300MHz	10	100	1000	3.0
7	NFL18SP507X1A3	10	500MHz	10	100	1000	2.0
8	NFL21SP106X1C3	10	10MHz	16	100	1000	8.5
9	NFL21SP206X1C7	10	20MHz	16	100	1000	8.5
10	NFL21SP506X1C3	10	50MHz	16	150	1000	3.5
11	NFL21SP706X1C3	10	70MHz	16	150	1000	3.0
12	NFL21SP107X1C3	10	100MHz	16	200	1000	2.0
13	NFL21SP157X1C3	10	150MHz	16	200	1000	2.0
14	NFL21SP207X1C3	10	200MHz	16	250	1000	1.5
15	NFL21SP307X1C3	10	300MHz	16	300	1000	1.2
16	NFL21SP407X1C3	10	400MHz	16	300	1000	1.2
17	NFL21SP507X1C3	10	500MHz	16	300	1000	1.2

No.	Part Number	Quantity (pcs.)	Cut-off Frequency	Attenuation (dB min.)										Rated Current	Rated Voltage
				10MHz	20MHz	50MHz	100MHz	150MHz	200MHz	300MHz	400MHz	500MHz	1GHz		
18	NFW31SP106X1E4	10	10MHz	6dB max.	5	25	25	-	25	-	-	30	30	200mA	25V
19	NFW31SP206X1E4	10	20MHz	-	6dB max.	5	25	-	25	-	-	30	30	200mA	25V
20	NFW31SP506X1E4	10	50MHz	-	-	6dB max.	10	-	30	-	-	30	30	200mA	25V
21	NFW31SP107X1E4	10	100MHz	-	-	-	6dB max.	-	5	-	-	20	30	200mA	25V
22	NFW31SP157X1E4	10	150MHz	-	-	-	-	6dB max.	-	10	20	30	30	200mA	25V
23	NFW31SP207X1E4	10	200MHz	-	-	-	-	-	6dB max.	-	-	10	30	200mA	25V
24	NFW31SP307X1E4	10	300MHz	-	-	-	-	-	-	6dB max.	-	5	15	200mA	25V
25	NFW31SP407X1E4	10	400MHz	-	-	-	-	-	-	-	6dB max.	-	10	200mA	25V
26	NFW31SP507X1E4	10	500MHz	-	-	-	-	-	-	-	-	6dB max.	10	200mA	25V

●EKEMFA20E (Chip EMIFIL® LC Combined Array Type)

No.	Part Number	Quantity (pcs.)	Cut-off Frequency	Rated Voltage (Vdc)	Rated Current (mA)	Insulation Resistance (MΩ min.)
1	NFA18SL137V1A45	10	130MHz	10	50	1000
2	NFA18SL187V1A45	10	180MHz	10	50	1000
3	NFA18SL207V1A45	10	200MHz	10	50	1000
4	NFA18SL307V1A45	10	300MHz	10	100	1000
5	NFA18SL407V1A45	10	400MHz	10	100	1000
6	NFA18SL487V1A45	10	480MHz	10	100	1000
7	NFA21SL506X1A48	10	50MHz	10	20	1000
8	NFA21SL806X1A48	10	80MHz	10	20	1000
9	NFA21SL207X1A45	10	200MHz	10	100	1000
10	NFA21SL207X1A48	10	200MHz	10	100	1000
11	NFA21SL307X1A45	10	300MHz	10	100	1000
12	NFA21SL307X1A48	10	300MHz	10	100	1000

Continued on the following page. ↗

Chip EMI Suppression Filter Design Kits

Continued from the preceding page.

No.	Part Number	Quantity (pcs.)	Cut-off Frequency	Rated Voltage (Vdc)	Rated Current (mA)	Insulation Resistance (MΩ min.)
13	NFA21SL287V1A45	10	280MHz	10	100	1000
14	NFA21SL287V1A48	10	280MHz	10	100	1000
15	NFA21SL317V1A45	10	310MHz	10	100	1000
16	NFA21SL317V1A48	10	310MHz	10	100	1000
17	NFA21SL337V1A45	10	330MHz	10	100	1000
18	NFA21SL337V1A48	10	330MHz	10	100	1000

●EKEMNFMPH (Chip EMIFIL[®] for Large Current)

No.	Part Number	Quantity (pcs.)	Capacitance	Rated Voltage (Vdc)	Rated Current (A)	Insulation Resistance (MΩ min.)
1	NFM18PC104R1C3	10	0.1μF±20%	16	2	1000
2	NFM18PC224R0J3	10	0.22μF±20%	6.3	2	1000
3	NFM18PC474R0J3	10	0.47μF±20%	6.3	2	1000
4	NFM18PC105R0J3	10	1μF±20%	6.3	2	500
5	NFM18PC225B0J3	10	2.2μF±20%	6.3	2	200
6	NFM18PC225B1A3	10	2.2μF±20%	10	4	200
7	NFM18PS474R0J3	10	0.47μF±20%	6.3	2	1000
8	NFM18PS105R0J3	10	1μF±20%	6.3	2	500
9	NFM21PC104R1E3	10	0.1μF±20%	25	2	1000
10	NFM21PC224R1C3	10	0.22μF±20%	16	2	1000
11	NFM21PC474R1C3	10	0.47μF±20%	16	2	1000
12	NFM21PC105B1A3	10	1μF±20%	10	4	500
13	NFM21PC105B1C3	10	1μF±20%	16	4	500
14	NFM21PC225B0J3	10	2.2μF±20%	6.3	4	200
15	NFM21PC475B1A3	10	4.7μF±20%	10	6	100
16	NFE31PC276B0J3	10	27μF±20%	6.3	6	20
17	NFE31PT152Z1E9	10	1500pF +50/-20%	25	6	1000
18	NFE31PT22Z1E9	10	2200pF±50%	25	6	1000
19	NFE61PT102E1H9	10	1000pF +80/-20%	50	2	1000
20	NFE61PT472C1H9	10	4700pF +80/-20%	50	2	1000
21	NFM41PC204F1H3	10	0.2μF +80/-20%	50	2	1000
22	NFM41PC155B1E3	10	1.5μF±20%	25	6	300

●EKEMDL21J (Chip Common Mode Choke Coils)

No.	Part Number	Quantity (pcs.)	Common Mode Impedance (at 100MHz, 20 degrees C)	Rated Voltage (Vdc)	Rated Current (mA)	Insulation Resistance (MΩ min.)
1	DLW21HN670SQ2	10	67Ω±25%	50	330	10
2	DLW21HN900SQ2	10	90Ω±25%	50	330	10
3	DLW21HN121SQ2	10	120Ω±25%	50	280	10
4	DLW21HN181SQ2	10	180Ω±25%	50	250	10
5	DLW21SN670SQ2	10	67Ω±25%	50	400	10
6	DLW21SN900SQ2	10	90Ω±25%	50	330	10
7	DLW21SN121SQ2	10	120Ω±25%	50	370	10
8	DLW21SN181SQ2	10	180Ω±25%	50	330	10
9	DLW21SN261SQ2	10	260Ω±25%	50	300	10
10	DLW21SN371SQ2	10	370Ω±25%	50	280	10
11	DLW21SN670HQ2	10	67Ω±25%	20	320	10
12	DLW21SN900HQ2	10	90Ω±25%	20	280	10
13	DLW21SN121HQ2	10	120Ω±25%	20	280	10
14	DLW21SR670HQ2	10	67Ω±25%	20	400	10

Continued on the following page. 

Chip EMI Suppression Filter Design Kits

Continued from the preceding page.

No.	Part Number	Quantity (pcs.)	Common Mode Impedance (at 100MHz, 20 degrees C)	Rated Voltage (Vdc)	Rated Current (mA)	Insulation Resistance (MΩ min.)
15	DLP0NSN670HL2	10	67Ω±20%	5	110	100
16	DLP0NSN900HL2	10	90Ω±20%	5	100	100
17	DLP0NSN121HL2	10	120Ω±20%	5	90	100
18	DLP11SN670SL2	10	67Ω±20%	5	180	100
19	DLP11SN121SL2	10	120Ω±20%	5	140	100
20	DLP11SN161SL2	10	160Ω±20%	5	120	100
21	DLP11SN900HL2	10	90Ω±20%	5	150	100
22	DLP11SN201HL2	10	200Ω±20%	5	110	100
23	DLP11SN241HL2	10	240Ω±20%	5	100	100
24	DLP11SN281HL2	10	280Ω±20%	5	90	100
25	DLP11SN331HL2	10	330Ω±20%	5	80	100
26	DLP11SA350HL2	10	35Ω±25%	5	170	100
27	DLP11SA670HL2	10	67Ω±25%	5	150	100
28	DLP11SA900HL2	10	90Ω±25%	5	150	100
29	DLP2ADN670HL4	10	67Ω±20%	5	140	100
30	DLP2ADN900HL4	10	90Ω±20%	5	130	100
31	DLP2ADN121HL4	10	120Ω±20%	5	120	100
32	DLP2ADN161HL4	10	160Ω±20%	5	100	100
33	DLP2ADN201HL4	10	200Ω±20%	5	90	100
34	DLP2ADN241HL4	10	240Ω±20%	5	80	100
35	DLP2ADN281HL4	10	280Ω±20%	5	80	100

●EKEMDCC5B (Chip Common Mode Choke Coils for DC Power Line / SMD Block type EMIFIL® for Power Line)

No.	Part Number	Quantity (pcs.)	Common Mode Impedance (at 100MHz, 20 degrees C)	Rated Voltage (Vdc)	Rated Current (mA)	Insulation Resistance (MΩ min.)
1	DLW5AHN402SQ2	5	4000Ω (Typ.)	50	200	10
2	DLW5BSN191SQ2	5	190Ω (Typ.)	50	5000	10
3	DLW5BSN351SQ2	5	350Ω (Typ.)	50	2000	10
4	DLW5BSN102SQ2	5	1000Ω (Typ.)	50	1500	10
5	DLW5BSN152SQ2	5	1500Ω (Typ.)	50	1000	10
6	DLW5BSN302SQ2	5	3000Ω (Typ.)	50	500	10
7	DLW5BTN101SQ2	5	100Ω (Typ.)	50	6000	10
8	DLW5BTN251SQ2	5	250Ω (Typ.)	50	5000	10
9	DLW5BTN501SQ2	5	500Ω (Typ.)	50	4000	10
10	DLW5BTN102SQ2	5	1000Ω (Typ.)	50	2000	10
11	DLW5BTN142SQ2	5	1400Ω (Typ.)	50	1500	10

No.	Part Number	Quantity (pcs.)	Insertion Loss	Rated Voltage (Vdc)	Rated Current (A)	Insulation Resistance (MΩ min.)
12	BNX022-01	5	1MHz to 1GHz: 35dB min.	50	10	500
13	BNX023-01	5	1MHz to 1GHz: 35dB min.	100	15	500

Outlines of Major Noise Regulation Standards

1. EMI Regulations

Equipment		Countries	Information Regulation	Japan	USA	Europe
Emission	Generic Standard		CISPR61000-6-3 (Residential, Commercial and Light Industry) IEC61000-6-4 (Industrial)			EN50081-1 (Residential, Commercial and Light Industry) EN50081-2 (Industrial)
	ITE: Information Technology Equipment Printers, Personal computers Word processors, Displays		CISPR 22	VCCI *1	FCC Part 15 Subpart B	EN55022
	ISM equipment, Microwaves		CISPR 11	*1	FCC Part 18	EN55011
	Igniter (Automobiles, Motorboats)		CISPR 12	JASO	FCC Part 15 Subpart B	Automotive Directive
	TVs, Radios, Audios, VTRs		CISPR 13	*1	FCC Part 15 Subpart B	EN55013
	Household electrical equipment Portable tools		CISPR 14	*1		EN55014
	Fluorescent Lamps, Luminaries		CISPR 15	*1	FCC Part 18	EN55015
	Transceivers		ITU-T	Radio Act ARIB (Voluntary Regulation)	FCC Part 15 Subpart C FCC Part 22	ETS300 Series
	(Reference) Power Supplies Higher Harmonics		IEC61000-3	Industrial Voluntary Regulation		EN61000-3
Immunity	Basic Standard		IEC61000-4	JIS C 61000-4		EN61000-4 Series
	Generic Standard		IEC61000-6-1 (Residential, Commercial and Light Industry) IEC61000-6-2 (Industrial)	JIS C 61000-6-1 (Residential, Commercial and Light Industry) JIS C 61000-6-2 (Industrial)		EN50082-1 (Residential, Commercial and Light Industry) EN50082-2 (Industrial)
	Industrial Process Measurement and Control Equipment					
	Radios, TVs		CISPR 20	Industrial Voluntary Action		EN55020
	ITE: Information Technology Equipment		CISPR 24			EN55024

*1 Electrical Appliance and Material Safety Law

There are EMI regulations in each country to meet EMI noise levels emitted from digital equipment.
 In the countries which regulate EMI, equipment which does not satisfy regulations is not allowed to be sold.

Continued on the following page.

Outlines of Major Noise Regulation Standards

Continued from the preceding page.

2. Measurement Point and Noise Detection

Regulation	Measuring Item	Polarization and Measuring Point	Frequency (Hz)	Detection	Measuring Devices
CISPR 22/ EN55022	Radiated Interference	Horizontal Pol. Vertical Pol.	30M to 1GHz	Quasi-Peak Detection	Antenna
	Main Interference Voltage	AC Main Ports	150k to 30MHz	Quasi-Peak Detection Mean Detection	Artificial Main Network
VCCI	Radiated Interference	Horizontal Pol. Vertical Pol.	30M to 1GHz	Quasi-Peak Detection	Dipole Antenna
	Main Interference Voltage	AC Main Ports	150k to 30MHz	Quasi-Peak Detection Mean Detection	Artificial Main Network
FCC Part 15	Radiated Interference	Horizontal Pol. Vertical Pol.	30M to 40GHz	Quasi-Peak Detection Mean Detection	Antenna
	Main Interference Voltage	AC Main Ports	150k to 30MHz	Quasi-Peak Detection	Artificial Main Network

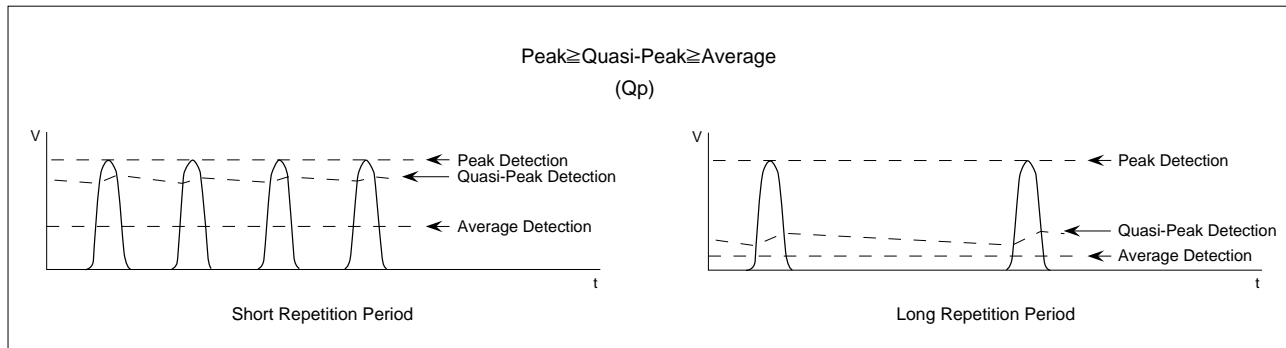

3. Limits of CISPR 22/EN55022

(1) CISPR 22 recommends measurement at 10m distance. However, other distance is acceptable if the limitation is converted according to the following calculation. Limitation shown left is converted to limitation for 3m distance.

Conversion

Limitation for 10m Distance	→	Limitation for 3m Distance
R_{10} (dB μ V/m)		R_3 (dB μ V/m)
r_{10} (μ V/m)		r_3 (μ V/m)
$R_{10} = 20 \log r_{10}$		$R_3 = 20 \log r_3$
		$R_3 = R_{10} + 20 (1 - \log 3)$
		$r_3 = \frac{10}{3} r_{10}$

Main Terminal Interference Voltage (Power Supply)

Class	Quasi-peak value (dB μ V)	Mean value (dB μ V)
Class A	73	60
Class B	50	46

Radiated Interference

Class	Field Strength (dB μ V/m)
Class A	57
Class B	47

On the border frequency, lower limit should be applied.

Class A Equipment: The equipment which is used in light industrial commercial areas.

Class B Equipment: The equipment which is used in residential areas.

Continued on the following page. ↗

Outlines of Major Noise Regulation Standards

☒ Continued from the preceding page.

(2) Scope of CISPR 22 Regulation

This regulation applies to information technology equipment (ITE) which is defined as:

- (a) Equipment that receives data from external signal sources;
- (b) Equipment that processes received data;
- (c) Equipment that outputs data; and
- (d) Equipment that has less than 600V rated voltage in power supply.

CISPR Regulations

- CISPR 10 Organization, Regulations and Procedures of CISPR
- CISPR 11 Industrial, Scientific and Medical (ISM) Radio-Frequency Equipment
- CISPR 12 Vehicles, Motor Boats and Spark-Ignited Engine driven
- CISPR 13 Sound and Television Receivers
- CISPR 14 Household Electrical Appliances, Portable Tools and Similar Electrical Apparatus
- CISPR 15 Fluorescent Lamps and luminaries
- CISPR 16 Radio Interference Measuring Apparatus and Measurement Methods
- CISPR 17 Passive Radio Interference Filters and Suppression Components
- CISPR 18 Power Transmission Cables and High Voltage equipment
- CISPR 19 Microwave Ovens for Frequencies above 1GHz
- CISPR 20 Immunity of Sound and TV Broadcast Receivers and Associated Equipment
- CISPR 21 Interference to Mobile Radio Communications in the Presence of Impulsive Noise
- CISPR 22 Information Technology Equipment
- CISPR 23 Industrial Scientific and Medical (ISM) Equipment
- CISPR 24 Immunity Regulation of Information Technology Equipment
- CISPR 25 Receiver used onboard vehicles, boats, and on devices

4. Limits of VCCI Voluntary Regulation

- (1) VCCI recommends measurement at 10m distance; 3m or 30m distance measurements are also allowed.

(2) Scope of VCCI Voluntary Regulation

This regulation applies to information technology equipment (same as CISPR Pub.22), but the application is excluded on the following equipment:

- Equipment for which other regulations already exist (e.g., household electrical appliances, radio and TV receivers)
- In station equipment principal purpose of which is electrical communication
- Industrial plant control system for which information processing is a secondary system function
- Industrial, commercial and medical testing and measuring systems for which data processing is a secondary system function
- Information equipment for which CISPR is conducting further deliberation

VCCI is the acronym of Voluntary Control Council for Interference by Data Processing Equipment and Electronic Office Machines.

VCCI is organized by the following organizations:

- Japan Electronics and Information Technology Industries Association (JEITA)
- Japan Business Machine and Information System Industries Association (JBMIA)
- Communication and Information Network Association of Japan (CIAJ)

Main Terminal Interference Voltage (Power Supply)

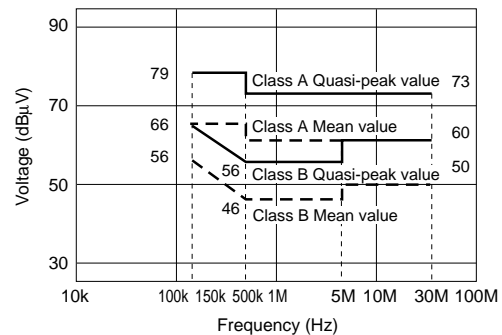

Radiated Interference

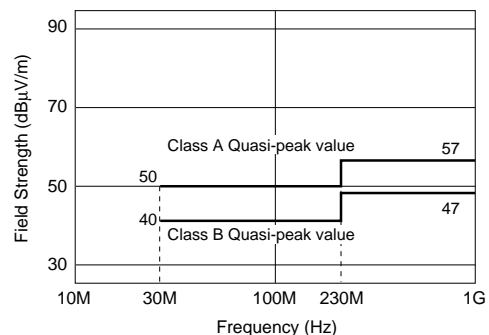

On the border frequency, lower limit should be applied.

Class B ITE: Equipment that is designed to be used at home.

Class A ITE: Equipment that does not meet interference limits of class B equipment, but satisfies interference limits of class A equipment.

Continued on the following page. ☒

Outlines of Major Noise Regulation Standards

☞ Continued from the preceding page.

5. Limits of FCC Part 15 Subpart B

- (1) Class A recommended to be measured with 10m distance.
Class B recommended to be measured with 3m distance.
- (2) The FCC Part 15 regulation controls radiated interference by establishing quasi-peak and mean value limits for frequencies ranging from 30MHz to 40GHz (or maximum frequency's fifth harmonic, whichever is lower).
For AC main ports, the FCC Part 15 regulation controls main terminal interference voltage by establishing quasipeak value limits for frequencies ranging from 450kHz to 30MHz.

Measurement Frequency Range for Radiated Interference

Maximum Frequency the Equipment Internally Generates, Uses or Operates or Synchronizes (MHz)	Upper End of Measurement Frequency Range (MHz)
Less than 1.705	30
1.705 to 108	1000
108 to 500	2000
500 to 1000	5000
Over 1000	Maximum Frequency's Fifth Harmonic or 40GHz, Whichever is Lower

Main Terminal Interference Voltage (Power Supply)

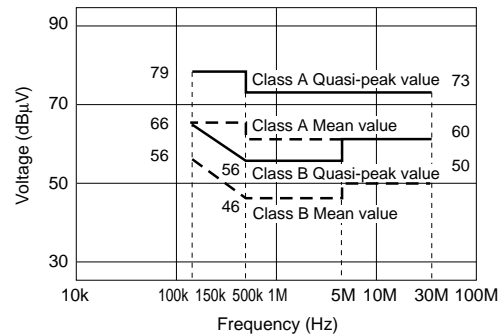

Radiated Interference



On the border frequency, lower limit should be applied.

Class A Equipment: The digital equipment that is sold for commercial, industrial and office use.

Class B Equipment: The digital equipment that is sold to be used in residential areas.

- (3) There is no regulation on power interference.

FCC Regulations

- Part 1 Procedures
- Part 2 Frequency Division and Radio Wave Treaty Issues and General Rules
- Part 15 Radio Wave Equipment
 - Intentionally electromagnetic radiation equipment
 - Non-intentionally electromagnetic radiation equipment
 - Incidentally electromagnetic radiation equipment
- Part 18 Industrial, Scientific and Medical Equipment
- Part 22 Public Mobile Wireless Operations
- Part 68 Connecting Terminal Equipment to Telephone Circuit Network
- Part 76 Cable Television

Continued on the following page. ☞

Outlines of Major Noise Regulation Standards

 Continued from the preceding page.

6. Immunity Regulations in the European Union

All electric/electronic equipment cannot be sold in Europe without CE marking. To use CE marking, they must satisfy related EC directives such as EMC directives. For Information Technology Equipment, in EMC directive, emission regulations are integrated, and immunity regulations are applied. Although these immunity regulations are prepared by CENELEC, almost all contents are same as standards issued by IEC or CISPR.

All products which are sold in EU must satisfy EC directives which contain immunity regulations.

Principal EC Directive	
EMC Directive	89/336/EEC 92/31/EEC
Low-Voltage Electrical Products Directive	73/23/EEC
Machines Directive	89/392/EEC

7. Immunity Regulations in Japan

Equipment	Association
TV, Radio, Audio	JEITA (Japan Electronics and Information Technology)
ITE	
Office Machine	JBMIA (Japan Business Machine and Information System Industries Association)
Mi	CIAJ (Communication and Information Network Association of Japan) ARIB (Association of Radio Industries and Business)
Machine To Builders	JMTBA (Japan Machine Tool Builders' Association)
Industrial Measuring Control Equipment	JEMIMA (Japan Electric Measuring Instruments Manufacturers' Association)
Industrial Robot	JARA (Japan Robot Association)

The table on the right shows the preparation situation of JIS for EMC. At this moment, the immunity standards by JIS do not have a legal force like the Electrical Application and Material Safety Law/VCCI.

Classification	Information Regulation	JIS
Terms	ISO60050-161 (IEV terms 161)	JIS C 0161
Basic Standards	IEC61000-4- 2	JIS C 61000-4-2
	IEC61000-4- 3	JIS C 61000-4-3
	IEC61000-4- 4	JIS C 61000-4-4
	IEC61000-4- 5	JIS C 61000-4-5
	IEC61000-4- 6	JIS C 61000-4-6
	IEC61000-4- 7	JIS C 61000-4-7
	IEC61000-4- 8	JIS C 61000-4-8
	IEC61000-4-11	JIS C 61000-4-11
	IEC61000-4-14	JIS C 61000-4-14
	IEC61000-4-17	JIS C 61000-4-17
Generic Standards	IEC61000-6-1	JIS C 61000-6-1
	IEC61000-6-2	JIS C 61000-6-2

Principles of Noise Suppression by DC EMIFIL®

1. Function of DC EMI Suppression Filters

DC EMI suppression filters absorb and eliminate high frequency noise which may produce electromagnetic interference in PC board circuits.

These filters are used in secondary circuits, and are small in size and light in weight, which further enhances their excellent noise suppression functions.

Chip and adhesive type filters can be mounted on PC boards automatically.

These filters are effective in the suppression of radiation noise in computers, peripheral equipment, and digital circuit application equipment (including various types of microcomputer application equipment), and function to suppress noise in audio/visual equipment, which uses digital memory chips and DSP.

These filters are also effective for improving the noise immunity of equipment used in noisy environments (such as electronic equipment for automobiles).

2. Noise Filter Suppression Principles

Generally, noise problems occur when the noise source and electronic equipment sensitive to the influence of noise are located in close proximity to one another.

In such situations, as shown in Figure at right, noise is conducted through a conductor, which produces an inductive field around the noise source.

To overcome such noise problems, it is preferable to reduce the amount of noise generated by the noise source or improve the noise resistance of adjacent equipment.

In order to satisfy equipment performance specifications and eliminate noise effectively at the same time, however, it is customary to reduce the amount of noise generated by the noise source, if it can't be eliminated altogether.

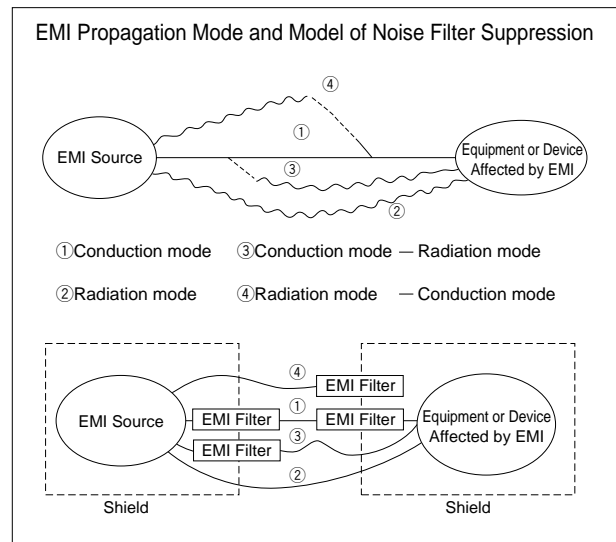

3. Configuration of EMI Suppression Filters (DC)

DC EMI suppression filters are used to suppress noise produced by conductors. Noise radiation can be suppressed, if it is eliminated with a filter in advance.

Generally, such noise suppression is achieved with DC EMI suppression filters, according to the capacitive and inductive frequency characteristics of the respective conductors in the circuit.

Filters of this kind can be roughly divided into those:

- (1) employing a capacitor,
- (2) employing an inductor,
- (3) employing a capacitor and inductor combination.

Continued on the following page. ↗

Principles of Noise Suppression by DC EMIFIL[®]

Continued from the preceding page.

4. Capacitive Noise Suppression

When a capacitor is connected (bypass capacitor) to ground from a noisy signal line or power line, the circuit impedance decreases as the frequency increases. Since noise is a high frequency phenomenon, it flows to ground if a capacitor has been connected to ground, thereby making it possible to eliminate noise. (See Fig.) EMI suppression filters employing a capacitor in this way are used to eliminate this type of noise.



5. High frequency Capacitor Characteristics Used for EMI Suppression Filters

Even general-purpose capacitors can be used for noise suppression. However, since noise has an extremely high frequency range, general-purpose capacitors may not function as effective bypass capacitors, due to the large residual inductance built into the capacitor. All the capacitors used in Murata's EMI suppression filters employ a three terminal structure or thru-type structure, which functions effectively even at high frequencies, thereby minimizing the influence of residual inductance. Consequently, an effective filter circuit can be formed even at frequencies exceeding 1GHz. (Refer to Fig.)



6. Inductive Noise Suppression

When an inductor is inserted in series in a noise producing circuit (See Fig.), its impedance increases with frequency. In this configuration it is possible to attenuate and eliminate noise components (high frequency components). The Murata EMI suppression filter functions in this way.



Continued on the following page. ↗

Principles of Noise Suppression by DC EMIFIL®

Continued from the preceding page.

7. Characteristics of Inductors Used in EMI Suppression Filters

General-purpose inductors also function to suppress noise when configured in series with a noise producing circuit. However, when general-purpose inductors are used, resonance may result in peripheral circuits, signal wave forms may become distorted, and satisfactory impedance may not be obtained at noise frequencies (due to insufficient high frequency impedance characteristics).

The inductors used for Murata's EMI suppression filters are designed to function nearly as a resistor at noise frequencies, which greatly reduces the possibility of resonance and leaves signal wave forms undistorted. And since sufficient impedance is obtained for frequencies ranging to hundreds of MHz, these specifically designed inductors operate effectively to suppress high-frequency noise. (See Fig.)

Equivalent Circuit

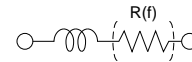

(Resistance element becomes dominant at high frequency.)

Example of impedance frequency characteristics of inductor type EMIFIL®

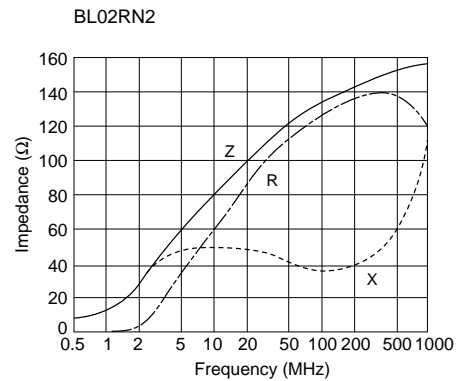

8. Capacitive-Inductive EMI Suppression Filters

If capacitive and inductive suppression characteristics are combined, it is possible to configure a much higher performance filter. In signal circuit applications where this combination is applied, noise suppression effects which have little influence on the signal wave form become possible.

This type of filter is also effective in the suppression of high-speed signal circuit noise. When used in DC power circuits, capacitive-inductive filters prevent resonance from occurring in peripheral circuits, thus making it possible to achieve significant noise suppression under normal service conditions.

9. Other EMI Suppression Filters

In addition to the capacitive-inductive filter, Murata also has an EMI suppression filter (EMIGUARD®) combining a capacitor with a varistor, useful for surge absorption; and a common mode choke coil effective, for common mode noise suppression.

Murata also has a range of built-in filter connectors which greatly reduce filter mounting space requirements.

Continued on the following page. ↗

Principles of Noise Suppression by DC EMIFIL®

Continued from the preceding page.

10. Expressing EMI Suppression Filter Effects

EMI Suppression Filter effects are expressed in terms of the insertion loss measured in the circuit, normally specified in MIL-STD 220A. As shown in the 50Ω impedance circuit in the Figure at right, insertion loss is represented by the logarithmic ratio of the circuit output voltage with and without a filter in the circuit, which is multiplied by 20 and expressed in dB.

Therefore, an insertion loss of 20dB indicates an output voltage ratio (B/C) of 1/10, and an insertion loss of 40dB indicates an output voltage ratio (B/C) of 1/100.

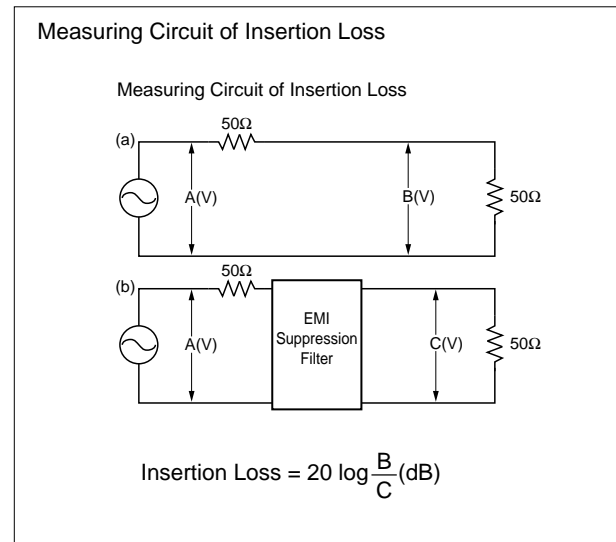



Murata EMI Filter Selection Simulator Ver. 3.6.0

New products are available

1 Select circuit.

(Select a new simulation circuit from File menu.)

2 Enter "Input Signal".

3 Set Driver IC.

4 Select filter.

(EMI filters or/and chip capacitor from the pull-down list.)

5 Set Transmission Line.

6 Set Receiver IC.

7 Click measuring point.

(Only for chip ferrite bead)

8 Click "Start Simulation" button.

9 Simulation results are displayed.

- Simulation results with various charts are quickly displayed on your PC.
- Results can be displayed in standard format or user defined scaling.
- Simulates various types of circuits such as Differential Mode Transmission, ceramic capacitor, EMIFIL®, three terminal capacitor and chip ferrite beads.
- Provides a simulation function that selects best suited Chip EMIFIL®.

1 Select circuit.

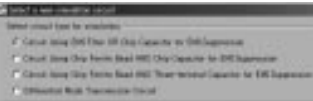

Select a new simulation circuit from File menu.

4 Filters can be selected from "frequency-impedance characteristics" charts.



9 Simulation results are shown in the window.

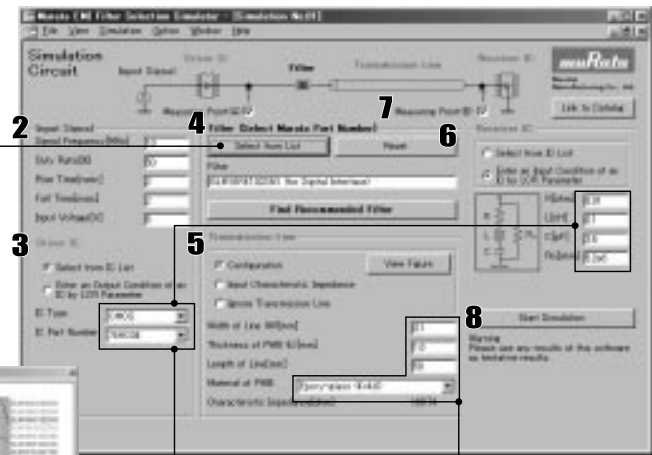

Two ways of setting the driver/receiver IC parameter

The logic IC of TTL and CMOS can be selected from pull-down list or the LCR values can also be created.

Impedance automatically calculated.

Impedance characteristics of transmission line are automatically calculated.

Link to the web catalog is available

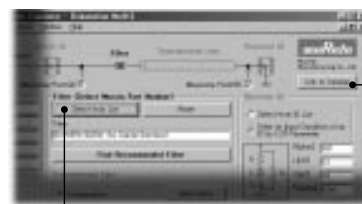

This button allows you to see more information at web catalog. (Need connection to the Internet)



EMIFIL® is the trademark of Murata Manufacturing Co., Ltd.

This simulator can be downloaded from Murata's website.

<http://www.murata.com/designlib/mefss/>



⚠Note:

1. Export Control

<For customers outside Japan>

No muRata products should be used or sold, through any channels, for use in the design, development, production, utilization, maintenance or operation of, or otherwise contribution to (1) any weapons (Weapons of Mass Destruction [nuclear, chemical or biological weapons or missiles] or conventional weapons) or (2) goods or systems specially designed or intended for military end-use or utilization by military end-users.

<For customers in Japan>

For products which are controlled items subject to the "Foreign Exchange and Foreign Trade Law" of Japan, the export license specified by the law is required for export.

2. Please contact our sales representatives or product engineers before using the products in this catalog for the applications listed below, which require especially high reliability for the prevention of defects which might directly damage a third party's life, body or property, or when one of our products is intended for use in applications other than those specified in this catalog.

- | | |
|-----------------------------|--|
| ① Aircraft equipment | ② Aerospace equipment |
| ③ Undersea equipment | ④ Power plant equipment |
| ⑤ Medical equipment | ⑥ Transportation equipment (vehicles, trains, ships, etc.) |
| ⑦ Traffic signal equipment | ⑧ Disaster prevention / crime prevention equipment |
| ⑨ Data-processing equipment | ⑩ Application of similar complexity and/or reliability requirements to the applications listed above |

3. Product specifications in this catalog are as of July 2008. They are subject to change or our products in it may be discontinued without advance notice. Please check with our sales representatives or product engineers before ordering. If there are any questions, please contact our sales representatives or product engineers.

4. Please read rating and ⚠ CAUTION (for storage, operating, rating, soldering, mounting and handling) in this catalog to prevent smoking and/or burning, etc.

5. This catalog has only typical specifications because there is no space for detailed specifications. Therefore, please approve our product specifications or transact the approval sheet for product specifications before ordering.

6. Please note that unless otherwise specified, we shall assume no responsibility whatsoever for any conflict or dispute that may occur in connection with the effect of our and/or a third party's intellectual property rights and other related rights in consideration of your use of our products and/or information described or contained in our catalogs. In this connection, no representation shall be made to the effect that any third parties are authorized to use the rights mentioned above under licenses without our consent.

7. No ozone depleting substances (ODS) under the Montreal Protocol are used in our manufacturing process.



<http://www.murata.com/>

Head Office
1-10-1, Higashi Kotari, Nagaokakyo-shi, Kyoto 617-8555, Japan
Phone: 81-75-951-9111

International Division
3-29-12, Shibuya, Shibuya-ku, Tokyo 150-0002, Japan
Phone: 81-3-5469-6123 Fax: 81-3-5469-6155 E-mail: intl@murata.co.jp