

### Multilayer NTC Thermistors

Series: **ERTJ**

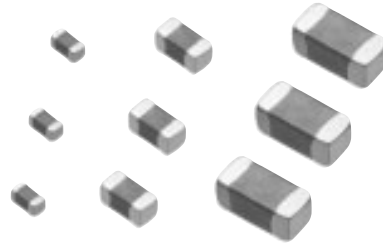

#### ■ Features

- Surface Mount Device (0201, 0402, 0603)
- Highly reliable multilayer / monolithic structure
- Wide temperature operating range (-40 to 125 °C)
- Environmentally-friendly lead-free

#### ■ Recommended Applications

- Mobile Phone
  - Temperature compensation for crystal oscillator
  - Temperature compensation for semiconductor devices
- Personal Computer
  - Temperature detection for CPU and memory device
  - Temperature compensation for ink-viscosity (Inkjet Printer)
- Battery Pack
  - Temperature detection of battery cells
- Liquid Crystal Display
  - Temperature compensation of display contrast
  - Temperature compensation of display backlighting (CCFL)

#### ■ Handling Precautions

Please see Pages 371 to 375

#### ■ Packaging Methods

Please see Page 364

#### ■ Explanation of Part Numbers

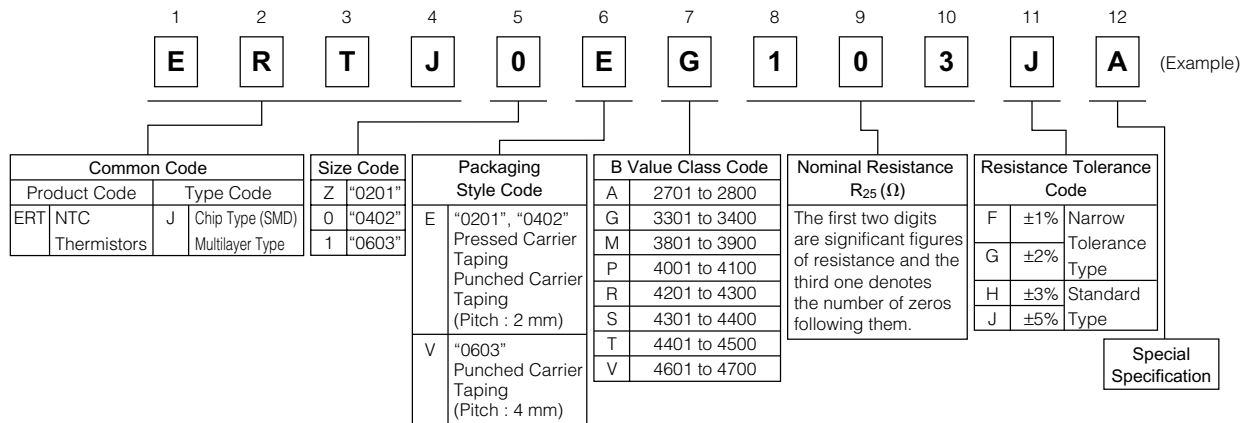

#### ■ Construction

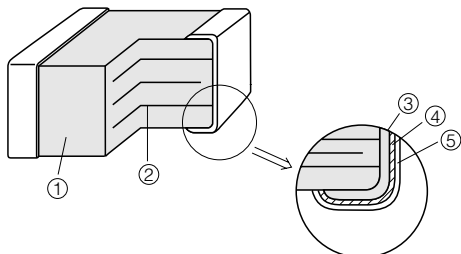

No	Name	
①	Semiconductive Ceramics	
②	Internal electrode	
③	Terminal electrode	Substrate electrode
④		Intermediate electrode
⑤		External electrode

Design and specifications are each subject to change without notice. Ask factory for the current technical specifications before purchase and/or use. Should a safety concern arise regarding this product, please be sure to contact us immediately.

00 Sep. 2010

### ■ Dimensions in mm (not to scale)

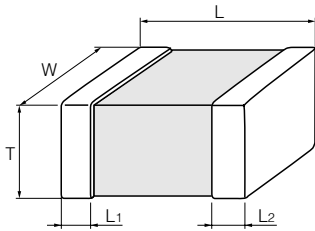

Size Code (EIA)	L	W	T	L <sub>1</sub> , L <sub>2</sub>
Z(0201)	0.60±0.03	0.30±0.03	0.30±0.03	0.15±0.05
0(0402)	1.0±0.1	0.50±0.05	0.50±0.05	0.25±0.15
1(0603)	1.60±0.15	0.8±0.1	0.8±0.1	0.3±0.2

(Unit : mm)

### ■ Packaging Methods

#### ● Standard Packing Quantities

Size Code	Thickness (mm)	Kind of Taping	Pitch (mm)	Quantity (pcs./reel)
Z(0201)	0.3	Pressed Carrier Taping	2	15,000
0(0402)	0.5	Punched Carrier Taping	2	10,000
1(0603)	0.8		4	4,000

#### ● Pitch 2 mm (Pressed Carrier Taping) : Size 0201

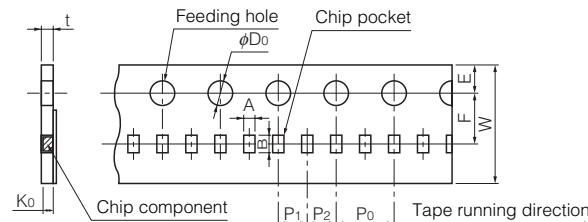

Symbol	A	B	W	F	E	P <sub>1</sub>	P <sub>2</sub>	P <sub>0</sub>	φD <sub>0</sub>	t	K <sub>0</sub>
Dim. (mm)	0.36 ±0.03	0.66 ±0.03	8.0 ±0.2	3.50 ±0.05	1.75 ±0.10	2.00 ±0.05	2.00 ±0.05	4.0 ±0.1	1.5 <sup>+0.1</sup> <sub>0</sub>	0.55 max.	0.36 ±0.03

#### ● Pitch 2 mm (Punched Carrier Taping) : Size 0402

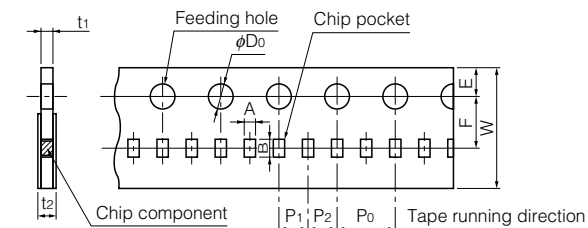

Symbol	A	B	W	F	E	P <sub>1</sub>	P <sub>2</sub>	P <sub>0</sub>	φD <sub>0</sub>	t <sub>1</sub>	t <sub>2</sub>
Dim. (mm)	0.62 ±0.05	1.12 ±0.05	8.0 ±0.2	3.50 ±0.05	1.75 ±0.10	2.00 ±0.05	2.00 ±0.05	4.0 ±0.1	1.5 <sup>+0.1</sup> <sub>0</sub>	0.7 max.	1.0 max.

#### ● Pitch 4 mm (Punched Carrier Taping) : Size 0603

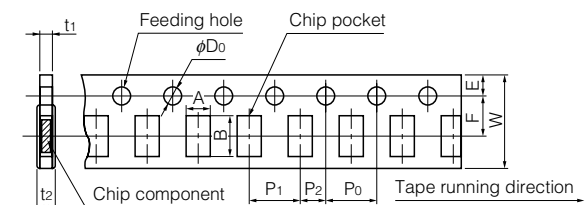

Symbol	A	B	W	F	E	P <sub>1</sub>	P <sub>2</sub>	P <sub>0</sub>	φD <sub>0</sub>	t <sub>1</sub>	t <sub>2</sub>
Dim. (mm)	1.0 ±0.1	1.8 ±0.1	8.0 ±0.2	3.50 ±0.05	1.75 ±0.10	4.0 ±0.1	2.00 ±0.05	4.0 ±0.1	1.5 <sup>+0.1</sup> <sub>0</sub>	1.1 max.	1.4 max.

#### ● Reel for Taping

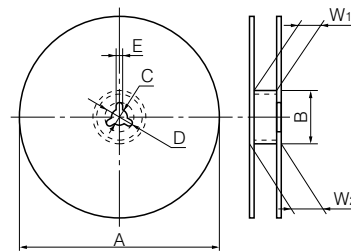

Symbol	φA	φB	C	D	E	W <sub>1</sub>	W <sub>2</sub>
Dim. (mm)	180 <sup>0</sup> <sub>-3</sub>	60.0 <sup>+1.0</sup> <sub>0</sub>	13.0±0.5	21.0±0.8	2.0±0.5	9.0 <sup>+1.0</sup> <sub>0</sub>	11.4±1.0

#### ● Leader Part and Taped End

##### Leader part

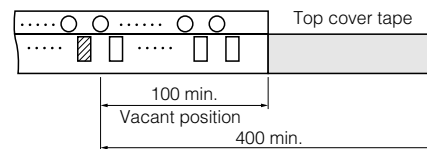

##### Taped end

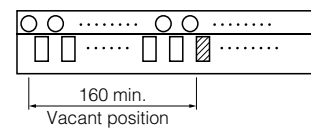

(Unit : mm)

### ■ Minimum Quantity / Packing Unit

Part Number (Size)	Minimum Quantity / Packing Unit	Packing Quantity in Carton	Carton L×W×H (mm)
ERTJZ (0201)	15,000	300,000	250×200×200
ERTJ0 (0402)	10,000	200,000	250×200×200
ERTJ1 (0603)	4,000	80,000	250×200×200

Part No., quantity and country of origin are designated on outer packages in English.

### ■ Ratings

Size code (EIA)	Z(0201)	0(0402)	1(0603)
Operating Temperature Range	-40 to 125 °C		
Rated Maximum Power Dissipation*1	33 mW	66 mW	100 mW
Dissipation Factor*2	approximately 1 mW/°C	approximately 2 mW/°C	approximately 3 mW/°C

\*1 Rated Maximum Power Dissipation : The maximum power that can be continuously applied at the rated ambient temperature.  
 · The Maximum Power Dissipation under ambient temperature 25 °C or less is the same with the rated maximum power dissipation, and Maximum power dissipation beyond 25 °C depends on the Decreased power dissipation curve.  
 · Please see "Operating Power" for details paging 371.

\*2 Dissipation factor : The constant amount power required to raise the temperature of the Thermistor 1 °C through self heat generation under stable temperatures.  
 · Dissipation factor is the reference value when mounted on a glass epoxy board (1.6 mmT).

### ● Resistance ratios to R<sub>25</sub> at each temperature/Reference values

(for obtaining resistance at each temperature by using R<sub>25</sub> shown in part number)

	ERTJ□□A~		ERTJ□□G~	ERTJ□□M~	ERTJ□□P~	ERTJ□□R~	ERTJ0ES~	ERTJ1VS~	ERTJ□□T~	ERTJ0ET104□	ERTJ□□V~
B <sub>25/50</sub>	2750 K	2800 K	(3375 K)	3900 K	4050 K	4250K	4330K	(4330K)	4500K	4500K	4700K
B <sub>25/85</sub>	(2700 K)	(2750 K)	3435 K	(3970 K)	(4100 K)	(4300K)	(4390K)	4390K	(4450K)	(4580K)	(4750K)
T(°C)									*1	*2	
-40	13.05	13.28	20.52	32.11	33.10	43.10	45.67	45.53	63.30	47.07	59.76
-35	10.21	10.40	15.48	23.29	24.03	30.45	32.08	31.99	42.92	33.31	41.10
-30	8.061	8.214	11.79	17.08	17.63	21.76	22.80	22.74	29.50	23.80	28.61
-25	6.427	6.547	9.069	12.65	13.06	15.73	16.39	16.35	20.53	17.16	20.14
-20	5.168	5.261	7.037	9.465	9.761	11.48	11.91	11.89	14.46	12.49	14.33
-15	4.191	4.261	5.507	7.147	7.362	8.466	8.743	8.727	10.30	9.159	10.31
-10	3.424	3.476	4.344	5.444	5.599	6.300	6.479	6.469	7.407	6.772	7.482
-5	2.819	2.856	3.453	4.181	4.291	4.730	4.845	4.839	5.388	5.046	5.481
0	2.336	2.362	2.764	3.237	3.312	3.582	3.654	3.650	3.966	3.789	4.050
5	1.948	1.966	2.227	2.524	2.574	2.734	2.778	2.776	2.953	2.864	3.015
10	1.635	1.646	1.806	1.981	2.013	2.102	2.128	2.126	2.221	2.179	2.262
15	1.380	1.386	1.474	1.567	1.584	1.629	1.642	1.641	1.687	1.669	1.710
20	1.171	1.174	1.211	1.247	1.255	1.272	1.277	1.276	1.293	1.287	1.303
25	1	1	1	1	1	1	1	1	1	1	1
30	0.8585	0.8565	0.8309	0.8072	0.8016	0.7921	0.7888	0.7890	0.7799	0.7823	0.7734
35	0.7407	0.7372	0.6941	0.6556	0.6461	0.6315	0.6263	0.6266	0.6131	0.6158	0.6023
40	0.6422	0.6376	0.5828	0.5356	0.5235	0.5067	0.5004	0.5007	0.4856	0.4876	0.4721
45	0.5595	0.5541	0.4916	0.4401	0.4266	0.4090	0.4022	0.4025	0.3874	0.3884	0.3723
50	0.4899	0.4836	0.4165	0.3635	0.3496	0.3319	0.3251	0.3254	0.3111	0.3111	0.2954
55	0.4309	0.4238	0.3543	0.3018	0.2881	0.2709	0.2642	0.2645	0.2513	0.2504	0.2356
60	0.3806	0.3730	0.3027	0.2518	0.2386	0.2222	0.2158	0.2161	0.2042	0.2026	0.1889
65	0.3376	0.3295	0.2595	0.2111	0.1985	0.1832	0.1772	0.1774	0.1670	0.1648	0.1523
70	0.3008	0.2922	0.2233	0.1777	0.1659	0.1518	0.1463	0.1465	0.1377	0.1348	0.1236
75	0.2691	0.2600	0.1929	0.1504	0.1393	0.1264	0.1213	0.1215	0.1144	0.1108	0.1009
80	0.2417	0.2322	0.1672	0.1278	0.1174	0.1057	0.1011	0.1013	0.09560	0.09162	0.08284
85	0.2180	0.2081	0.1451	0.1090	0.09937	0.08873	0.08469	0.08486	0.08033	0.07609	0.06834
90	0.1974	0.1871	0.1261	0.09310	0.08442	0.07468	0.07122	0.07138	0.06782	0.06345	0.05662
95	0.1793	0.1688	0.1097	0.07980	0.07200	0.06307	0.06014	0.06028	0.05753	0.05314	0.04712
100	0.1636	0.1528	0.09563	0.06871	0.06166	0.05353	0.05099	0.05112	0.04903	0.04472	0.03939
105	0.1498	0.1387	0.08357	0.05947	0.05306	0.04568	0.04340	0.04351	0.04198	0.03784	0.03308
110	0.1377	0.1263	0.07317	0.05170	0.04587	0.03918	0.03708	0.03718	0.03609	0.03218	0.02791
115	0.1270	0.1153	0.06421	0.04512	0.03979	0.03374	0.03179	0.03188	0.03117	0.02748	0.02364
120	0.1175	0.1056	0.05650	0.03951	0.03460	0.02916	0.02734	0.02742	0.02702	0.02352	0.02009
125	0.1091	0.09695	0.04986	0.03470	0.03013	0.02527	0.02359	0.02367	0.02351	0.02017	0.01712

\*1 Other than ERTJ0ET104□ in B<sub>25/50</sub> = 4500K.

\*2 ERTJ0ET104□ only.

$$B_{25/50} = \frac{\ln(R_{25}/R_{50})}{1/298.15 - 1/323.15}$$

$$B_{25/85} = \frac{\ln(R_{25}/R_{85})}{1/298.15 - 1/358.15}$$

R<sub>25</sub>=Resistance at 25.0±0.1 °C  
 R<sub>50</sub>=Resistance at 50.0±0.1 °C  
 R<sub>85</sub>=Resistance at 85.0±0.1 °C

Design and specifications are each subject to change without notice. Ask factory for the current technical specifications before purchase and/or use.  
 Should a safety concern arise regarding this product, please be sure to contact us immediately.

### ■ Specification and Test Method

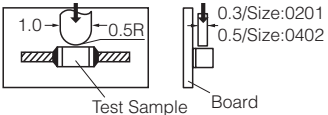
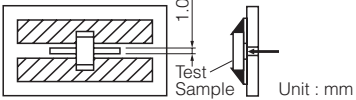
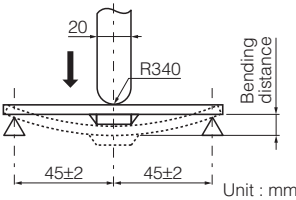
Item	Specification	Test Method																		
Rated Zero-power Resistance (R <sub>25</sub> )	Within the specified tolerance.	The value of the d.c. resistance shall be measured at the rated ambient temperature of 25.0 ±0.1 °C under the power less than 0.1mW which is negligible self heat generation.																		
B Value	Within the specified tolerance. * Individual Specification shall specify B <sub>25/50</sub> or B <sub>25/85</sub> .	The Zero-power resistances; R <sub>1</sub> and R <sub>2</sub> , shall be measured respectively at T <sub>1</sub> (°C) and T <sub>2</sub> (°C). The B value is calculated by the following equation. $B_{T_1/T_2} = \frac{\ln(R_1) - \ln(R_2)}{1/(T_1 + 273.15) - 1/(T_2 + 273.15)}$ <table border="1"> <thead> <tr> <th></th> <th>T<sub>1</sub></th> <th>T<sub>2</sub></th> </tr> </thead> <tbody> <tr> <td>B<sub>25/50</sub></td> <td>25.0 ±0.1 °C</td> <td>50.0 ±0.1 °C</td> </tr> <tr> <td>B<sub>25/85</sub></td> <td>25.0 ±0.1 °C</td> <td>85.0 ±0.1 °C</td> </tr> </tbody> </table>		T <sub>1</sub>	T <sub>2</sub>	B <sub>25/50</sub>	25.0 ±0.1 °C	50.0 ±0.1 °C	B <sub>25/85</sub>	25.0 ±0.1 °C	85.0 ±0.1 °C									
	T <sub>1</sub>	T <sub>2</sub>																		
B <sub>25/50</sub>	25.0 ±0.1 °C	50.0 ±0.1 °C																		
B <sub>25/85</sub>	25.0 ±0.1 °C	85.0 ±0.1 °C																		
Adhesion	The terminal electrode shall be free from peeling or signs of peeling.	Applied force : Size 0201 : 2 N Size 0402, 0603 : 5 N Duration : 10 s  Size : 0201, 0402  Size : 0603  Unit : mm																		
Bending Strength	There shall be no cracks and other mechanical damage. R <sub>25</sub> change : within ±5 %	Bending distance : 1 mm Bending speed : 1 mm/s  Unit : mm																		
Resistance to Soldering Heat	There shall be no cracks and other mechanical damage. <table border="1"> <thead> <tr> <th></th> <th>Narrow Tol. type</th> <th>Standard type</th> </tr> </thead> <tbody> <tr> <td>R<sub>25</sub> change</td> <td>: within ±2 %</td> <td>within ±3 %</td> </tr> <tr> <td>B Value change</td> <td>: within ±1 %</td> <td>within ±2 %</td> </tr> </tbody> </table>		Narrow Tol. type	Standard type	R <sub>25</sub> change	: within ±2 %	within ±3 %	B Value change	: within ±1 %	within ±2 %	Soldering bath method Solder temperature : 270 ±5 °C Dipping period : 3.0 ±0.5 s Preheat condition : <table border="1"> <thead> <tr> <th>Step</th> <th>Temp (°C)</th> <th>Period (s)</th> </tr> </thead> <tbody> <tr> <td>1</td> <td>80 to 100</td> <td>120 to 180</td> </tr> <tr> <td>2</td> <td>150 to 200</td> <td>120 to 180</td> </tr> </tbody> </table>	Step	Temp (°C)	Period (s)	1	80 to 100	120 to 180	2	150 to 200	120 to 180
	Narrow Tol. type	Standard type																		
R <sub>25</sub> change	: within ±2 %	within ±3 %																		
B Value change	: within ±1 %	within ±2 %																		
Step	Temp (°C)	Period (s)																		
1	80 to 100	120 to 180																		
2	150 to 200	120 to 180																		
Solderability	More than 75 % of the soldered area of both terminal electrodes shall be covered with fresh solder.	Soldering bath method Solder temperature : 230 ±5 °C Dipping period : 4 ±1 s Solder : H63A (JIS-Z-3282)																		

## ■ Specification and Test Method

Item	Specification		Test Method
Temperature Cycling	Narrow Tol. type R <sub>25</sub> change : within ±2 % B Value change : within ±1 %	Standard type within ±3 % within ±2 %	Conditions of one cycle Step 1 : -40 °C, 30±3 min Step 2 : Room temp., 3 min max. Step 3 : 125 °C, 30±3 min. Step 4 : Room temp., 3 min max. Number of cycles: 100 cycles
Moisture Resistance	Narrow Tol. type R <sub>25</sub> change : within ±2 % B Value change : within ±1 %	Standard type within ±3 % within ±2 %	Temperature : 85 ±2 °C Relative humidity : 85 ±5 % Test period : 1000 +48/0 h
Damp Heat Load	Narrow Tol. type R <sub>25</sub> change : within ±2 % B Value change : within ±1 %	Standard type within ±3 % within ±2 %	Temperature : 85 ±2 °C Relative humidity : 85 ±5 % Applied power : 10 mW Test period : 500 +24/0 h
Cold Resistance	Narrow Tol. type R <sub>25</sub> change : within ±2 % B Value change : within ±1 %	Standard type within ±3 % within ±2 %	Temperature : -40 ±3 °C Test period : 1000 +48/0 h
Dry Heat Resistance	Narrow Tol. type R <sub>25</sub> change : within ±2 % B Value change : within ±1 %	Standard type within ±3 % within ±2 %	Temperature : 125 ±3 °C Test period : 1000 +48/0 h

## ■ Part Number List of Narrow Tolerance Type (Resistance Tolerance : ±2 %, ±1 %)

### ● 0201(EIA)

Nominal Resistance at 25 °C	Resistance Tolerance	B value class code		G	P	V
		Nominal B value *( ) Reference value	B <sub>25/50</sub> B <sub>25/85</sub>	(3375 K) 3435 K±1 %	4050 K±1 % (4100 K)	4700 K±1 % (4750 K)
10 kΩ	±1 % (F) or ±2 % (G)			ERTJZEG103□A		
47 kΩ					ERTJZEP473□	
100 kΩ						ERTJZEV104□

□ : Resistance Tolerance Code  
Avoid flow soldering.

### ● 0402(EIA)

Nominal Resistance at 25 °C	Resistance Tolerance	B value class code		G	P	S	V
		Nominal B value *( ) Reference value	B <sub>25/50</sub> B <sub>25/85</sub>	(3375 K) 3435 K±1 %	4050 K±1 % (4100 K)	4330 K±1 % (4390 K)	4700 K±1 % (4750 K)
10 kΩ	±1 % (F) or ±2 % (G)			ERTJ0EG103□A			
47 kΩ					ERTJ0EP473□		
100 kΩ						ERTJ0ES104□	ERTJ0EV104□

□ : Resistance Tolerance Code  
Avoid flow soldering.

### ● 0603(EIA)

Nominal Resistance at 25 °C	Resistance Tolerance	B value class code		G	S
		Nominal B value *( ) Reference value	B <sub>25/50</sub> B <sub>25/85</sub>	(3375 K) 3435 K±1 %	(4330 K) 4390 K±1 %
10 kΩ	±1 % (F) or ±2 % (G)			ERTJ1VG103□A	
100 kΩ					ERTJ1VS104□A

□ : Resistance Tolerance Code  
Avoid flow soldering.

### ■ Part Number List of Standard Type (Resistance Tolerance : $\pm 5\%$ , $\pm 3\%$ )

#### ● 0201(EIA)

Nominal Resistance at 25 °C	Resistance Tolerance	B value class code		G	P	T	V
		Nominal B value *( ) Reference value	B <sub>25/50</sub> B <sub>25/85</sub>	(3375 K) 3435 K $\pm 2\%$	4050 K $\pm 3\%$ (4100 K)	4500 K $\pm 2\%$ (4450 K)	4700 K $\pm 2\%$ (4750 K)
2.0 k $\Omega$	$\pm 3\%$ (H) or $\pm 5\%$ (J)					ERTJZET202□	
3.0 k $\Omega$						ERTJZET302□	
4.7 k $\Omega$						ERTJZET472□	
10 k $\Omega$					ERTJZEG103□A		
47 k $\Omega$						ERTJZEP473□	
100 k $\Omega$							ERTJZEV104□

□ : Resistance Tolerance Code  
Avoid flow soldering.

#### ● 0402(EIA)

Nominal Resistance at 25 °C	Resistance Tolerance	B value class code		A	
		Nominal B value *( ) Reference value	B <sub>25/50</sub> B <sub>25/85</sub>	2750 K $\pm 3\%$ (2700 K)	2800 K $\pm 3\%$ (2750 K)
22 $\Omega$	$\pm 3\%$ (H) or $\pm 5\%$ (J)			ERTJ0EA220□	
33 $\Omega$				ERTJ0EA330□	
40 $\Omega$				ERTJ0EA400□	
47 $\Omega$				ERTJ0EA470□	
68 $\Omega$					ERTJ0EA680□
100 $\Omega$					ERTJ0EA101□
150 $\Omega$				ERTJ0EA151□	

Nominal Resistance at 25 °C	Resistance Tolerance	B value class code		G	M	P	R	
		Nominal B value *( ) Reference value	B <sub>25/50</sub> B <sub>25/85</sub>	(3375 K) 3435 K $\pm 1\%$	3900 K $\pm 2\%$ (3970 K)	4050 K $\pm 2\%$ (4100 K)	4250 K $\pm 2\%$ (4300 K)	
3.3 k $\Omega$	$\pm 3\%$ (H) or $\pm 5\%$ (J)						ERTJ0ER332□	
4.7 k $\Omega$							ERTJ0ER472□	
6.8 k $\Omega$							ERTJ0ER682□	
10 k $\Omega$					ERTJ0EG103□A	ERTJ0EM103□		ERTJ0ER103□
15 k $\Omega$								ERTJ0ER153□
22 k $\Omega$								ERTJ0ER223□
33 k $\Omega$							ERTJ0EP333□	ERTJ0ER333□
47 k $\Omega$							ERTJ0EP473□	
100 k $\Omega$							ERTJ0EP104□	

Nominal Resistance at 25 °C	Resistance Tolerance	B value class code		S	T	V	
		Nominal B value *( ) Reference value	B <sub>25/50</sub> B <sub>25/85</sub>	4330 K $\pm 2\%$ (4390 K)	4500 K $\pm 2\%$ (4450 K, 4580 K)	4700 K $\pm 2\%$ (4750 K)	
1.0 k $\Omega$	$\pm 3\%$ (H) or $\pm 5\%$ (J)				ERTJ0ET102□		
1.5 k $\Omega$					ERTJ0ET152□		
2.0 k $\Omega$					ERTJ0ET202□		
2.2 k $\Omega$					ERTJ0ET222□		
3.0 k $\Omega$					ERTJ0ET302□		
3.3 k $\Omega$					ERTJ0ET332□		
4.7 k $\Omega$					ERTJ0ET472□		
47 k $\Omega$						ERTJ0EV473□	
68 k $\Omega$						ERTJ0EV683□	
100 k $\Omega$					ERTJ0ES104□	ERTJ0ET104□	ERTJ0EV104□
150 k $\Omega$						ERTJ0ET154□	ERTJ0EV154□
220 k $\Omega$							ERTJ0EV224□
330 k $\Omega$							ERTJ0EV334□
470 k $\Omega$							ERTJ0EV474□

□ : Resistance Tolerance Code  
Avoid flow soldering.

Design and specifications are each subject to change without notice. Ask factory for the current technical specifications before purchase and/or use.  
Should a safety concern arise regarding this product, please be sure to contact us immediately.

● 0603(EIA)

Nominal Resistance at 25 °C	Resistance Tolerance	B value class code		A		G	P
		Nominal B value *( ) Reference value	B <sub>25/50</sub> B <sub>25/85</sub>	2750 K±3 % (2700 K)	2800 K±3 % (2750 K)	(3375 K) 3435 K±1 %	4050 K±3 % (4100 K)
22 Ω	±3 % (H) or ±5 % (J)			ERTJ1VA220□			
33 Ω				ERTJ1VA330□			
40 Ω					ERTJ1VA400□		
47 Ω					ERTJ1VA470□		
68 Ω					ERTJ1VA680□		
100 Ω					ERTJ1VA101□		
10 kΩ						ERTJ1VG103□A	
47 kΩ							ERTJ1VP473□

Nominal Resistance at 25 °C	Resistance Tolerance	B value class code		R	S	T	V
		Nominal B value *( ) Reference value	B <sub>25/50</sub> B <sub>25/85</sub>	4250 K±2 % (4300 K)	(4330 K) 4390 K±1 %	4500 K±2 % (4450 K)	4700 K±2 % (4750 K)
1.0 kΩ	±3 % (H) or ±5 % (J)					ERTJ1VT102□	
1.5 kΩ						ERTJ1VT152□	
2.0 kΩ						ERTJ1VT202□	
2.2 kΩ						ERTJ1VT222□	
3.0 kΩ						ERTJ1VT302□	
3.3 kΩ					ERTJ1VR332□		ERTJ1VT332□
4.7 kΩ					ERTJ1VR472□		ERTJ1VT472□
6.8 kΩ					ERTJ1VR682□		
10 kΩ					ERTJ1VR103□		
15 kΩ					ERTJ1VR153□		
22 kΩ					ERTJ1VR223□		
33 kΩ					ERTJ1VR333□		
47 kΩ					ERTJ1VR473□		ERTJ1VV473□
68 kΩ					ERTJ1VR683□		ERTJ1VV683□
100 kΩ						ERTJ1VS104□A	ERTJ1VV104□
150 kΩ							ERTJ1VV154□

□ : Resistance Tolerance Code  
Avoid flow soldering.

- Typical Application
- Temperature Detection

### Writing current control of HDD

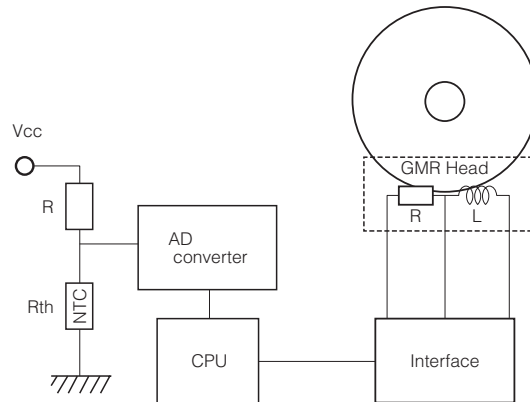

- Temperature Compensation (Pseudo-linearization)

### Contrast level control of LCD

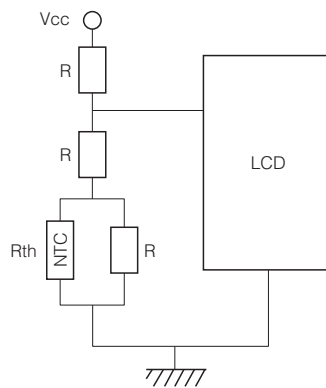

- Temperature Compensation (RF circuit)

### Temperature compensation of TCXO

