



Integrated  
Circuit  
Systems, Inc.

**PRELIMINARY**

**ICS8Mx0**  
LVCMOS/LVTTL CLOCK OSCILLATOR

**ICS8Mx0**

**LOW JITTER, HIGH FREQUENCY XTAL OSCILLATOR**

- Stable, ultra low jitter, LVCMOS/LVTTL clock generation
- For Gigabit Ethernet, Fibre Channel, PCI-Express, other applications
- Clock output frequencies from 75MHz to 250MHz
- One single-ended LVCMOS/LVTTL clock output
- Output Enable (OE) pin (high impedance – when low)
- Small 4-pin 5mm x 7mm x 1.5mm SMT ceramic package
- Low profile package allows back-side PCB mounting
- Pb-free RoHS compliant (by default; no additional code required)
- 3.3V or 2.5V device power supply options
- Commercial (0 to +70 °C) and Industrial (-40 to +85 °C) temperatures
- Frequency stability of ±50ppm or ±100ppm  
(including initial accuracy, operating temperature variation, supply voltage variation, load variation, reflow drift, and aging for 10 years)
- Low phase jitter < 1 ps rms maximum (12kHz to 20MHz)

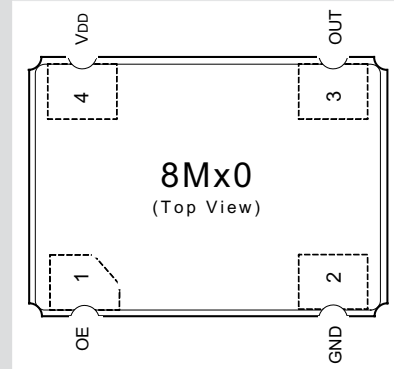

4-pin CERHERMETIC 5mm x 7mm x 1.5mm SMT

**ELECTRICAL SPECIFICATIONS**

Unless stated otherwise,  $V_{DD} = 3.3V \pm 0.3V$  or  $2.5V \pm 5\%$ ,  $T_A = 0^\circ C$  to  $+70^\circ C$  (commercial),  $T_A = -40^\circ C$  to  $+85^\circ C$  (industrial)

Item	Symbol	Specifications				Units	Test Conditions	
		Min.	Typ.	Max.				
<b>DC Characteristics</b>								
Power Supply ( $V_{DD}$ , GND pins)	Power Supply Voltage	$V_{DD}$	3.0	3.3	3.6	V	3.3V operation	
			2.375	2.5	2.625	V	2.5V operation (8MJ0 and 8MK0 only)	
	Power Supply Current	$I_{DD}$		75		mA	$OE = V_{DD}$	
	Current w/Output Disabled	$I_{OED}$			<0.6	mA	$OE = GND$	
	Input Capacitance	$C_{IN}$		4		pF		
Output Enable (OE pin) LVCMOS/LVTTL	Input High Voltage	$V_{IH}$	$0.7 * V_{DD}$			V		
	Input Low Voltage	$V_{IL}$			$0.3 * V_{DD}$	V		
	Input High Current	$I_{IH}$			5	$\mu A$	$V_{DD} = V_{IN} = 3.6V$ or $2.625V$	
	Input Low Current	$I_{IL}$	-150			$\mu A$	$V_{DD} = 3.6V$ or $2.625V$ , $V_{IN} = 0V$	
	Internal Pullup Resistor	$R_{PULLUP}$		51		k $\Omega$		
Clock Output Level (OUT pin) LVCMOS/LVTTL	Output High Voltage <sup>1</sup>	$V_{OH}$	$V_{DD} - 0.4$			V	$V_{DD} = 3.3V \pm 0.3V$ or $2.5V \pm 5\%$	
	Output Low Voltage <sup>1</sup>	$V_{OL}$			0.4	V		
	Output Load Condition	$C_L$			25	pF	$f_o \leq 250MHz$	
	Output Impedance	$R_{OUT}$		20		$\Omega$		
<b>AC Characteristics</b>								
Output (OUT pin)	Output Frequency Range		75		250	MHz	All conditions	
	Frequency Stability Error	$\Delta f/f_o$			$\pm 100$	ppm p-p	8MH0 & 8MK0	Includes frequency set, $V_{DD}$ , $T_A$ and load variation, reflow drift, 10 yr. aging
					$\pm 50$	ppm p-p	8MG0 & 8MJ0	
	Output Duty Cycle	odc		50		%	$V_{TH} = V_{DD} / 2$ , $C_L \leq \text{Max. pF}$	
	Output Rise Time	$t_R$			1.5	ns	20% to 80% of $V_{DD}$ , $C_L \leq \text{Max. pF}$	
	Output Fall Time	$t_F$			1.5	ns		
	Oscillator Start-up Time	$t_{OSC}$			10	ms	Time at Min. $V_{DD}$ (3.0V or 2.375V) to be 0s	
	RMS Phase Jitter, Random <sup>2</sup>	$t_{jit}(\sigma)$			<1	ps rms	design target	
	Jitter	$t_{DS}^3$			0.2		ps	Deterministic
					3		ps	Random, $\sigma$ of random jitter
				3		ps	Root Mean Square, $\sigma$ of total jitter distribution	
				25		ps	Peak-to-Peak	
	$t_{acc}^3$			4		ps	Accumulated Jitter, n = 2 to 50,000 cycles	

NOTE 1: Outputs terminated with  $50\Omega$  to  $V_{DD}/2$ . See Parameter Measurement Information, *Output Load AC Test Circuit Diagrams*.

NOTE 2: Measured using an Aeroflex PN9500 with a 12kHz to 20MHz integration range.

NOTE 3: Measured using a Wavecrest SIA-3000.

Supply Voltage & Frequency Accuracy		
G =	3.3V / 3.3V	±50 ppm
H =	3.3V / 3.3V	±100 ppm
J =	2.5V / 3.3V	±50 ppm
K =	2.5V / 3.3V	±100 ppm

The Preliminary Information presented herein represents a product in prototyping or pre-production. The noted characteristics are based on initial product characterization. Integrated Circuit Systems, Incorporated (ICS) reserves the right to change any circuitry or specifications without notice.



**PIN DESCRIPTIONS**

Number	Name	Type		Description
1	OE	Input	Pullup	Output enable pin. High Impedance when LOW. LVCMOS/LVTTL interface levels.
2	GND	Power		Power supply ground.
3	OUT	Output		Single-ended clock output. LVCMOS/LVTTL interface levels.
4	V <sub>DD</sub>	Power		Power supply pin.

For typical value of internal Pullup resistor, see DC Characteristics.

**ABSOLUTE MAXIMUM RATINGS**

Item	Symbol	Condition	Unit
Input Voltage	V <sub>I</sub>	-0.5 to V <sub>DD</sub> +0.5	V
Output Voltage	V <sub>O</sub>	-0.5 to V <sub>DD</sub> +0.5	V
Positive Supply Voltage	V <sub>DD</sub>	4.6	V
Package Thermal Impedence		TBD	°C/W (0lfpm)
Storage Temperature	T <sub>s</sub>	-40 to +100	°C

Stresses beyond those listed under Absolute Maximum Ratings may cause permanent damage to the device. These ratings are stress specifications only. Functional operation of product at these conditions or any conditions beyond those listed in DC Characteristics or AC Characteristics is not implied. Exposure to absolute maximum rating conditions for extended periods may affect product reliability.

**PARAMETER MEASUREMENT INFORMATION**

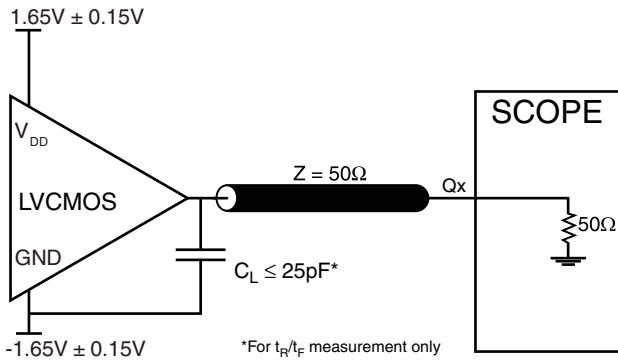

**3.3V OUTPUT LOAD AC TEST CIRCUIT**

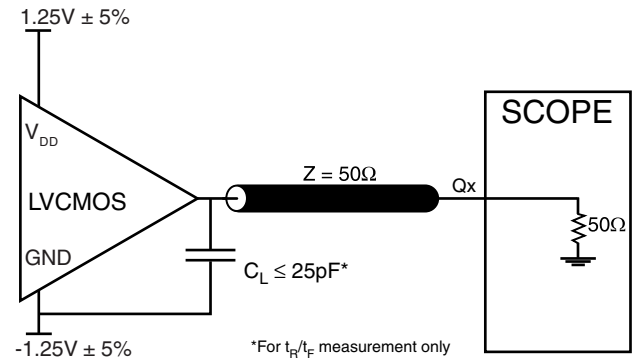

**2.5V OUTPUT LOAD AC TEST CIRCUIT**

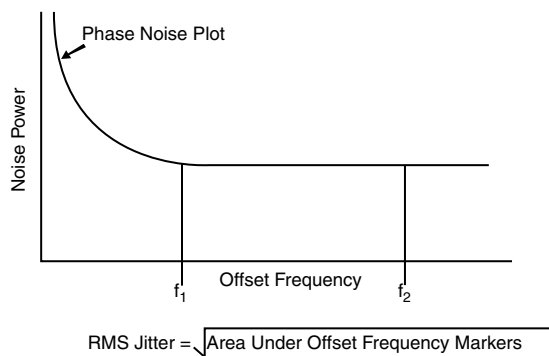

**RMS PHASE JITTER**

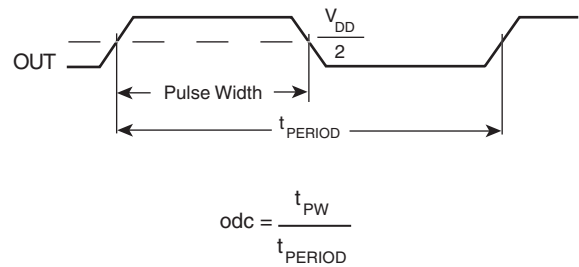

**OUTPUT DUTY CYCLE/PULSE WIDTH/PERIOD**

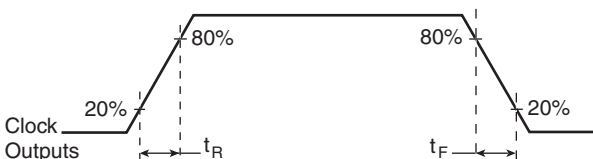

**OUTPUT RISE/FALL TIME**



**APPLICATION INFORMATION**

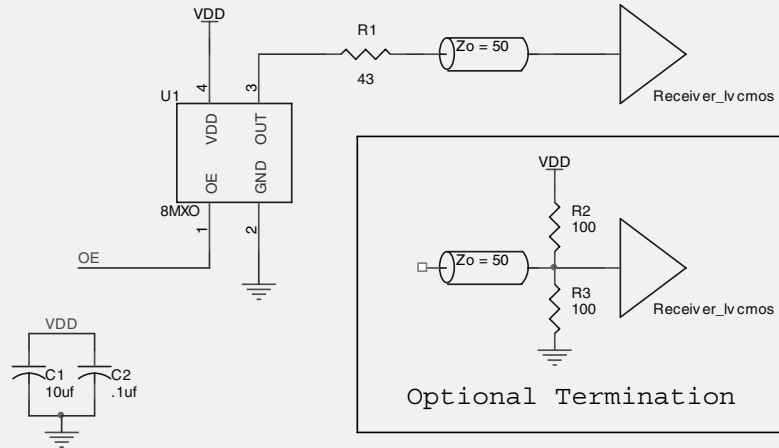

**LVCMOS APPLICATION SCHEMATIC / POWER SUPPLY FILTERING (DECOUPLING CIRCUIT)**

**PACKAGE OUTLINE - J SUFFIX FOR 4 LEAD SMT CERHERMETIC, 5mm x 7mm x 1.5mm**

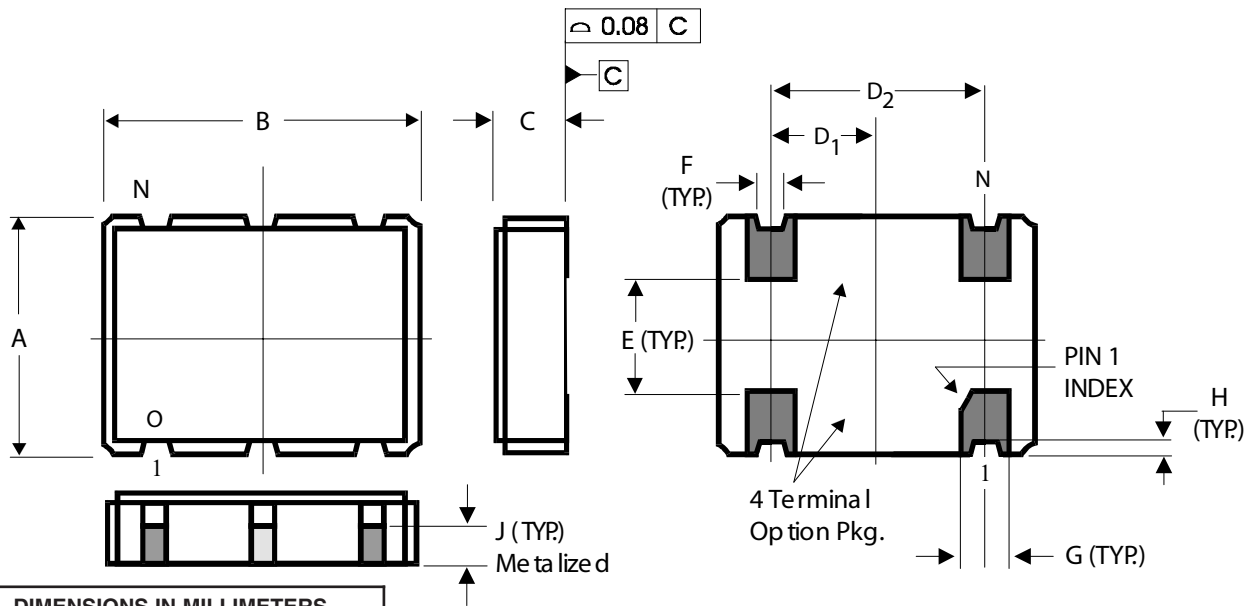

DIMENSIONS IN MILLIMETERS		
SYMBOL	Nominal	Tolerance
A	5	±0.15
B	7	±0.15
C	1.5	±0.15
D <sub>1</sub>	2.54	±0.13
D <sub>2</sub>	5.08	±0.13
E	2.6	±0.13
F	0.6	±0.13
G	1.4	±0.13
H	0.15 Ref.	-
J	0.65 Ref.	-



Integrated  
Circuit  
Systems, Inc.

**PRELIMINARY**

**ICS8Mx0**  
LVCMOS/LVTTL CLOCK OSCILLATOR

**ORDERING INFORMATION**

Part/Order Number*	Marking*	Package	Shipping Packaging	Temperature
ICS8Mx0-100.000AJ	ICS8Mx0 100.000	4 lead CERHERMETIC	Tube	0°C to 70°C
ICS8Mx0-100.000AJT	ICS8Mx0 100.000	4 lead CERHERMETIC	1000 Tape & Reel	0°C to 70°C
ICS8Mx0-106.250AJ	ICS8Mx0 106.250	4 lead CERHERMETIC	Tube	0°C to 70°C
ICS8Mx0-106.250AJT	ICS8Mx0 106.250	4 lead CERHERMETIC	1000 Tape & Reel	0°C to 70°C
ICS8Mx0-125.000AJ	ICS8Mx0 125.000	4 lead CERHERMETIC	Tube	0°C to 70°C
ICS8Mx0-125.000AJT	ICS8Mx0 125.000	4 lead CERHERMETIC	1000 Tape & Reel	0°C to 70°C
ICS8Mx0-156.250AJ	ICS8Mx0 156.250	4 lead CERHERMETIC	Tube	0°C to 70°C
ICS8Mx0-156.250AJT	ICS8Mx0 156.250	4 lead CERHERMETIC	1000 Tape & Reel	0°C to 70°C
ICS8Mx0-159.375AJ	ICS8Mx0 159.375	4 lead CERHERMETIC	Tube	0°C to 70°C
ICS8Mx0-159.375AJT	ICS8Mx0 159.375	4 lead CERHERMETIC	1000 Tape & Reel	0°C to 70°C
ICS8Mx0-187.500AJ	ICS8Mx0 187.500	4 lead CERHERMETIC	Tube	0°C to 70°C
ICS8Mx0-187.500AJT	ICS8Mx0 187.500	4 lead CERHERMETIC	1000 Tape & Reel	0°C to 70°C
ICS8Mx0-212.500AJ	ICS8Mx0 212.500	4 lead CERHERMETIC	Tube	0°C to 70°C
ICS8Mx0-212.500AJT	ICS8Mx0 212.500	4 lead CERHERMETIC	1000 Tape & Reel	0°C to 70°C
ICS8Mx0-250.000AJ	ICS8Mx0 250.000	4 lead CERHERMETIC	Tube	0°C to 70°C
ICS8Mx0-250.000AJT	ICS8Mx0 250.000	4 lead CERHERMETIC	1000 Tape & Reel	0°C to 70°C

\*See table below for Part/Order Number Information. Where "x" is applied, see *Supply Voltage & Frequency Accuracy* in the Part/Order Number Information table.

**PART/ORDER NUMBER INFORMATION**

**Part/Order Number:** ICS8M x 0 - fff.fff r p t u

**Device** \_\_\_\_\_

**Supply Voltage & Frequency Accuracy** \_\_\_\_\_  
 G = 3.3V ±50 ppm  
 H = 3.3V ±100 ppm  
 J = 2.5/3.3V ±50 ppm  
 K = 2.5/3.3V ±100 ppm

**Output Type** \_\_\_\_\_  
 0 = LVCMOS/LVTTL

**Output Frequency (MHz)** \_\_\_\_\_  
 Leading zeroes dropped. Fourth decimal place added if necessary.  
 Consult ICS for other frequencies.

**Revision of Product** \_\_\_\_\_  
 A = Initial Release

**Package Type (individual devices)** \_\_\_\_\_  
 J = 5x7mm ceramic SMT

**Ambient Temperature Range** \_\_\_\_\_  
 none = commercial = 0°C to +70°C  
 I = industrial = -40°C to +85°C

**Bulk Packaging option** \_\_\_\_\_  
 none = tube  
 T = tape and reel (1000 devices)

Note: Lead-free by default (no addition "LF" code needed).  
 (Pb-free and RoHS complaint)

The ICS logo is a registered trademark, and HiPerClockS is a trademark of Integrated Circuit Systems, Inc. All other trademarks are the property of their respective owners and may be registered in certain jurisdictions.

While the information presented herein has been checked for both accuracy and reliability, Integrated Circuit Systems, Incorporated (ICS) assumes no responsibility for either its use or for infringement of any patents or other rights of third parties, which would result from its use. No other circuits, patents, or licenses are implied. This product is intended for use in normal commercial and industrial applications. Any other applications such as those requiring high reliability or other extraordinary environmental requirements are not recommended without additional processing by ICS. ICS reserves the right to change any circuitry or specifications without notice. ICS does not authorize or warrant any ICS product for use in life support devices or critical medical instruments.