

## “ZNR” Transient/Surge Absorbers, SMD Type

Series: **VF**



### ■ Features

- Large withstanding surge current capability, in compact size
- Designed for flow/reflow solderings
- Excellent response against high steep surge voltage
- Low clamping voltage
- RoHS compliant

### ■ Recommended Applications

- Protection of communication modules (Modem, xDSL, Terminal Adaptor)
- Protection of consumer, industrial and automobile equipment
- Absorption of switching surge from relays

### ■ Handling Precautions

See Page 114 to 116

### ■ Packaging Specifications

See Page 147

### ■ Explanation of Part Numbers

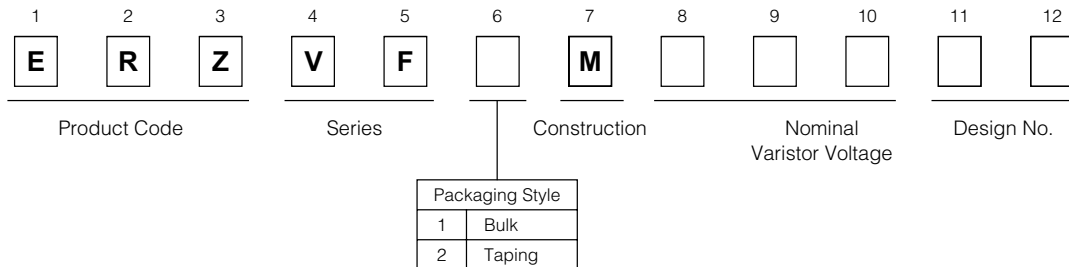

### ■ Construction

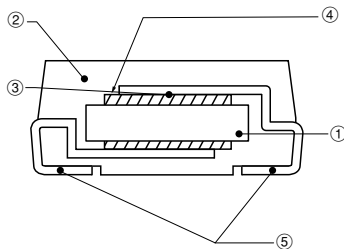

① ZNR element	ZnO etc.
② Resin mold	Epoxy Resin(UL94V-0 approved)
③ Conductive adhesive	Silver
④ Electrode	Silver
⑤ Lead terminals	Sn plated Ni-Fe Alloy

### ■ Dimensions in mm (not to scale)

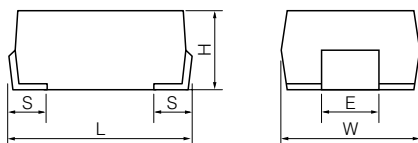

Type	W	L	H	S	E
VF□M	6.0±0.4	8.0±0.5	3.2±0.3	1.3±0.3	2.5±0.2

### ■ Ratings and Characteristics

- Operating Temperature Range: -40 to 85 °C
- Storage Temperature Range: -40 to 125 °C

Part No.	Varistor Voltage	Maximum Allowable Voltage		Clamping Voltage at I <sub>p</sub> (max.)		Rated Power (W)	Maximum Energy (2 ms) (J)	Maximum Peak Current (8/20 μs, 2 times) (A)	
	V <sub>1 mA</sub> (V)	ACrms (V)	DC (V)	V <sub>x A</sub> (V)	I <sub>p</sub> (A)				
Type VF□M	ERZVF□M220	22(20-24)	14	18	43	2.5	0.02	0.9	125
	ERZVF□M270	27(24-30)	17	22	53	2.5	0.02	1.0	125
	ERZVF□M330	33(30-36)	20	26	65	2.5	0.02	1.2	125
	ERZVF□M390	39(35-43)	25	31	77	2.5	0.02	1.5	125
	ERZVF□M470	47(42-52)	30	38	93	2.5	0.02	1.8	125
	ERZVF□M560	56(50-62)	35	45	110	2.5	0.02	2.2	125
	ERZVF□M680	68(61-75)	40	56	135	2.5	0.02	2.5	125
	ERZVF□M820	82(74-90)	50	65	135	10	0.25	3.5	600
	ERZVF□M101	100(90-110)	60	85	165	10	0.25	4.0	600
	ERZVF□M121	120(108-132)	75	100	200	10	0.25	5.0	600
	ERZVF□M151	150(135-165)	95	125	250	10	0.25	6.0	600
	ERZVF□M201	200(185-225)	130	170	340	10	0.25	8.0	600
	ERZVF□M221	220(198-242)	140	180	360	10	0.25	9.0	600
	ERZVF□M241	240(216-264)	150	200	395	10	0.25	10.0	600
	ERZVF□M271	270(247-303)	175	225	455	10	0.25	12.0	600
	ERZVF□M331	330(297-363)	210	270	545	10	0.1	8.0	300
	ERZVF□M361	360(324-396)	230	300	595	10	0.1	9.0	300
	ERZVF□M391	390(351-429)	250	320	650	10	0.1	9.0	300
	ERZVF□M431	430(387-473)	275	350	710	10	0.1	10.0	300
	ERZVF□M471	470(423-517)	300	385	775	10	0.1	10.0	300

↑ Packaging Style Code: "1" for bulk, "2" for embossed taping

- Typical Characteristics
- Voltage vs. Current
- ERZVF1(2)M220 to ERZVF1(2)M680

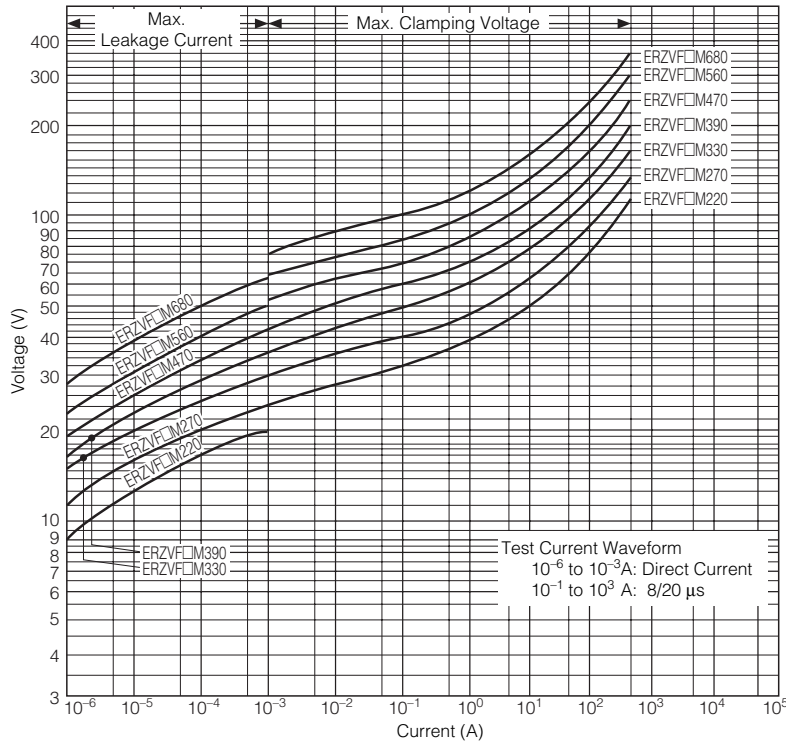

- Impulse
- ERZVF1(2)M220 to ERZVF1(2)M680

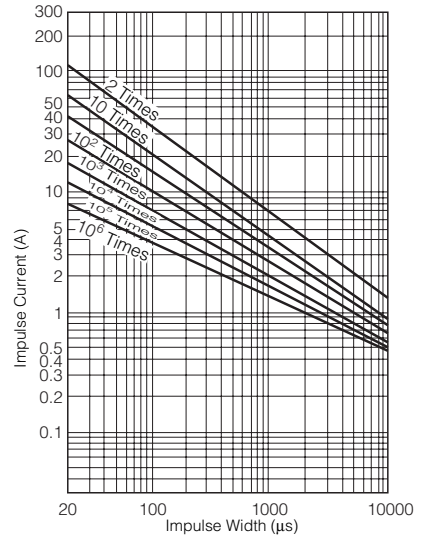

- ERZVF1(2)M820 to ERZVF1(2)M271

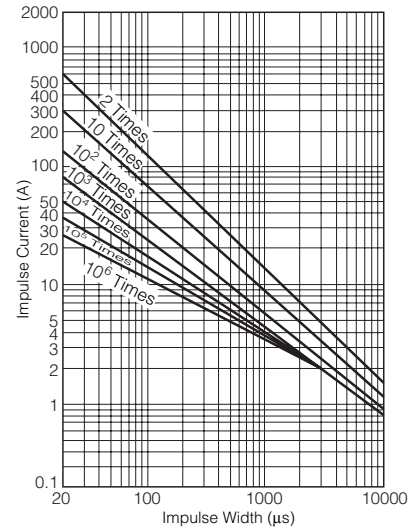

- ERZVF1(2)M820 to ERZVF1(2)M471

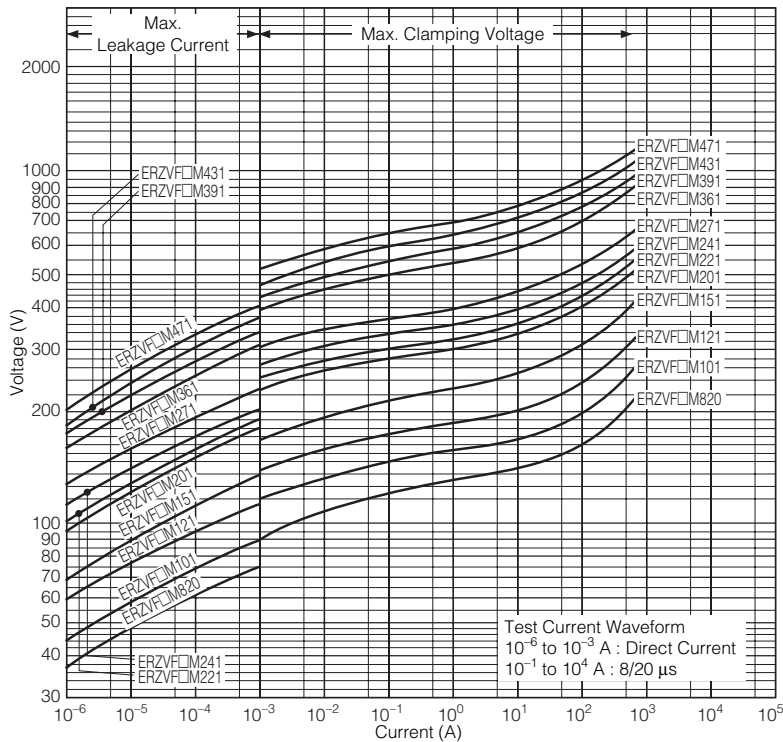

- ERZVF1(2)M331 to ERZVF1(2)M471

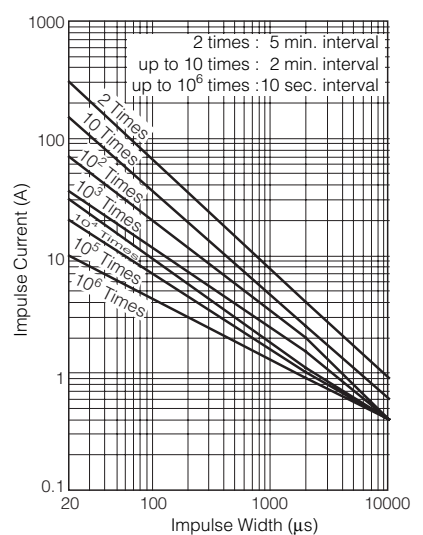

Design and specifications are each subject to change without notice. Ask factory for the current technical specifications before purchase and/or use. Should a safety concern arise regarding this product, please be sure to contact us immediately.

00 Apr. 2008

"ZNR" Transient/Surge Absorbers

## ■ Marking Contents

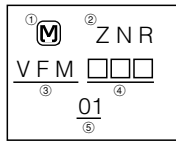

① Trade Mark	Trade Mark
② Product Name	ZNR, ZNR Surge Absorbers
③ Series	VF□M, VF Series
④ Abbreviation of Part No.	The first two digits are significant figures and the third one denotes the number of zeros following.
⑤ Date Code	Left(Year) 2006:F, 2007:G, 2008:H, 2009:J, 2010:0, 2011:1 Right(Month) Jan.:1 to Sep.:1 to 9, Oct.:O, Nov.:N, Dec.:D

## ■ Packaging Specifications

### ● Packing Quantity

Style	Quantity
Embossed taping	2000 pcs./reel
Bulk	200 pcs./bag

### ● Reel

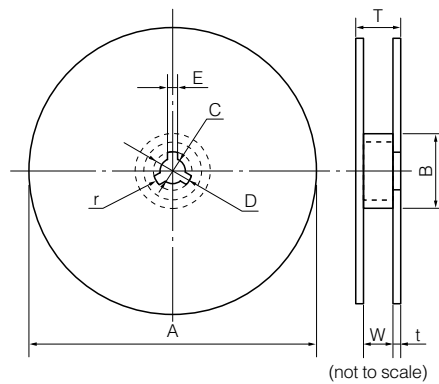

Dimensions (mm)	A	B	C	D	E
	382 max.	50 min.	13.0±0.5	21.0±0.8	2.0±0.5

Dimensions (mm)	W	T	t	r
	16.4 <sup>+2.0</sup> <sub>0</sub>	22.4 max.	2.5±0.5	1.0

### ● Embossed Taping

(W=16 mm)

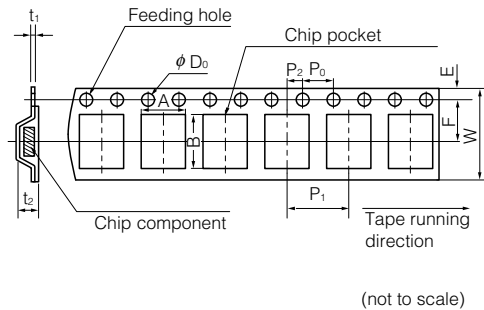

Dimensions (mm)	A	B	W	F	E	P <sub>1</sub>
	6.8±0.2	11.9 max.	16.0±0.3	7.5±0.1	1.75±0.10	8.0±0.1

Dimensions (mm)	P <sub>2</sub>	P <sub>0</sub>	φD <sub>0</sub>	t <sub>1</sub>	t <sub>2</sub>
	2.0±0.1	4.0±0.1	1.5 <sup>+0.1</sup> <sub>0</sub>	0.6 max.	6.5 max.

■ Performance Characteristics

Characteristics	Test Methods	Specifications												
Standard Test Condition	Electrical measurements (initial/after tests) shall be conducted at temperature of 5 to 35 °C, relative humidity of maximum 85 %	_____												
Varistor Voltage	The voltage between two terminals with the specified measuring current $I_{CmA}$ DC applied is called $V_c$ or $V_{CmA}$ . The measurement should be made as fast as possible to avoid heat effects.	To meet the specified value.												
Maximum Allowable Voltage	The recommended maximum sinusoidal wave voltage (rms) or the maximum DC voltage that can be applied continuously.													
Clamping Voltage	The maximum voltage between two terminals with the specified impulse current (8/20 $\mu$ s).													
Rated Power	The maximum power that can be applied within the specified ambient temperature.													
Maximum Energy	Maximum energy of less than $\pm 10$ % of the varistor voltage change when the standard impulse (2 ms) is applied one time.													
Maximum Peak Current	Maximum current of less than $\pm 10$ % of the varistor voltage change when impulse current (8/20 $\mu$ s) is applied twice continuously with an interval of 5 minutes.													
Temperature Coefficient of Varistor Voltage	$\frac{V_{CmA} \text{ at } 85 \text{ }^\circ\text{C} - V_{CmA} \text{ at } 25 \text{ }^\circ\text{C}}{V_{CmA} \text{ at } 25 \text{ }^\circ\text{C}} \times \frac{1}{60} \times 100(\%/^\circ\text{C})$	0 to $-0.05$ %/°C												
Impulse Life (I)	<p>The change of <math>V_c</math> shall be measured after the specified impulse is applied 10000 times continuously with an interval of 10 seconds at room temperature.</p> <table border="1"> <thead> <tr> <th>Part Number</th> <th>Waveform</th> <th>Current</th> </tr> </thead> <tbody> <tr> <td>ERZVF□M220 to ERZVF□M680</td> <td>8/20 <math>\mu</math>s</td> <td>18 A</td> </tr> <tr> <td>ERZVF□M820 to ERZVF□M271</td> <td>8/20 <math>\mu</math>s</td> <td>50 A</td> </tr> <tr> <td>ERZVF□M331 to ERZVF□M471</td> <td>8/20 <math>\mu</math>s</td> <td>30 A</td> </tr> </tbody> </table>	Part Number	Waveform	Current	ERZVF□M220 to ERZVF□M680	8/20 $\mu$ s	18 A	ERZVF□M820 to ERZVF□M271	8/20 $\mu$ s	50 A	ERZVF□M331 to ERZVF□M471	8/20 $\mu$ s	30 A	$\Delta V_{CmA}/V_{CmA} \leq \pm 10$ %
Part Number	Waveform	Current												
ERZVF□M220 to ERZVF□M680	8/20 $\mu$ s	18 A												
ERZVF□M820 to ERZVF□M271	8/20 $\mu$ s	50 A												
ERZVF□M331 to ERZVF□M471	8/20 $\mu$ s	30 A												
Impulse Life (II)	<p>The change of <math>V_c</math> shall be measured after the specified impulse is applied 100000 times continuously with an interval of 10 seconds at room temperature.</p> <table border="1"> <thead> <tr> <th>Part Number</th> <th>Waveform</th> <th>Current</th> </tr> </thead> <tbody> <tr> <td>ERZVF□M220 to ERZVF□M680</td> <td>8/20 <math>\mu</math>s</td> <td>12 A</td> </tr> <tr> <td>ERZVF□M820 to ERZVF□M271</td> <td>8/20 <math>\mu</math>s</td> <td>35 A</td> </tr> <tr> <td>ERZVF□M331 to ERZVF□M471</td> <td>8/20 <math>\mu</math>s</td> <td>20 A</td> </tr> </tbody> </table>	Part Number	Waveform	Current	ERZVF□M220 to ERZVF□M680	8/20 $\mu$ s	12 A	ERZVF□M820 to ERZVF□M271	8/20 $\mu$ s	35 A	ERZVF□M331 to ERZVF□M471	8/20 $\mu$ s	20 A	$\Delta V_{CmA}/V_{CmA} \leq \pm 10$ %
Part Number	Waveform	Current												
ERZVF□M220 to ERZVF□M680	8/20 $\mu$ s	12 A												
ERZVF□M820 to ERZVF□M271	8/20 $\mu$ s	35 A												
ERZVF□M331 to ERZVF□M471	8/20 $\mu$ s	20 A												

“ZNR” Transient/Surge Absorbers

Design and specifications are each subject to change without notice. Ask factory for the current technical specifications before purchase and/or use. Should a safety concern arise regarding this product, please be sure to contact us immediately.