

**“ZNR” Transient/Surge Absorbers, SMD Molded**

Type: **CF**  
Type: **SF**



■ **Features**

- Designed for flow/reflow solderings
- Excellent response against high steep surge voltage
- Large withstanding surge current capability in compact size
- Low clamping voltage for better surge protection

■ **Recommended Applications**

- Protection of semiconductors
- Protection of consumer equipment
- Protection of industrial equipment
- Protection of telephone or telecommunication systems
- Protection of automobile equipment
- Absorption of switching surge from relays
- Protection of electronic equipment from electrostatic discharge

■ **Handling Precautions**

■ **Explanation of Part Numbers**

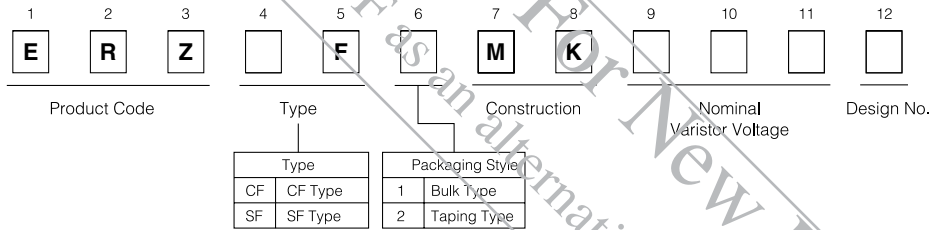

■ **Construction**

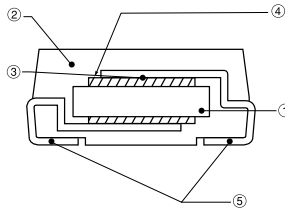

① ZNR element	ZnO etc.
② Resin mold	Epoxy Resin(UL94V-0 approved)
③ Conductive adhesive	Silver
④ Electrode	Silver
⑤ Lead terminals	Soldered Ni-Fe Alloy

■ **Dimensions in mm (not to scale)**

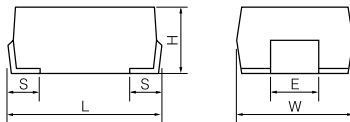

Series	W	L	H	S	E
CF	6.0±0.4	8.0±0.5	3.2±0.3	1.3±0.3	2.5±0.2
SF	6.2±0.4				

Design and specifications are subject to change without notice. Ask factory for technical specifications before purchase and/or use. Whenever a doubt about safety arises from this product, please contact us immediately for technical consultation.

(See ERZ-VF as an alternative)  
Not Recommended For New Designs

■ Ratings and Characteristics

- Operating Temperature Range: -40 to 85 °C
- Storage Temperature Range: -40 to 125 °C
- Temperature Coefficient of Varistor Voltage: 0 to -0.05 %/°C

Part No.	Varistor Voltage	Maximum Allowable Voltage		Clamping Voltage at Ip (max.)		Rated Power (W)	Maximum Energy (2 ms) (J)	Maximum Peak Current (8/20 μs, 2 times) (A)
	V <sub>0.1mA</sub> (V)	ACrms (V)	DC (V)	V <sub>CA</sub> (V)	I <sub>p</sub> (A)			
ERZCF□MK220	22 ( 20- 24)	14	18	48	1	0.01	0.4	50
ERZCF□MK270	27 ( 24- 30)	17	22	60	1	0.01	0.5	50
ERZCF□MK330	33 ( 30- 36)	20	26	73	1	0.01	0.6	50
ERZCF□MK390	39 ( 35- 43)	25	31	86	1	0.01	0.8	50
ERZCF□MK470	47 ( 42- 52)	30	38	104	1	0.01	1.0	50
ERZCF□MK560	56 ( 51- 62)	35	45	123	1	0.01	1.0	50
ERZCF□MK680	68 ( 61- 75)	40	56	150	1	0.01	1.2	50
ERZCF□MK820	82 ( 74- 90)	50	65	145	5	0.1	1.7	200
ERZCF□MK101	100 ( 90-110)	60	85	175	5	0.1	2.0	200
ERZCF□MK121	120 (108-132)	75	100	210	5	0.1	2.5	200
ERZCF□MK151	150 (135-165)	95	125	260	5	0.1	3.0	200
ERZCF□MK201	200 (185-225)	130	170	355	5	0.1	4.0	200
ERZCF□MK221	220 (198-242)	140	180	380	5	0.1	4.5	200
ERZCF□MK241	240 (216-264)	150	200	415	5	0.1	5.0	200
ERZCF□MK271	270 (247-303)	175	225	475	5	0.1	6.0	200
ERZCF□MK361	360 (324-396)	230	300	620	5	0.1	6.0	200
ERZCF□MK391	390 (351-429)	250	320	675	5	0.1	6.0	200
ERZCF□MK431	430 (387-473)	275	350	745	5	0.1	6.3	200
ERZCF□MK471	470 (423-517)	300	385	810	5	0.1	7.0	200

⌞ Packaging Style Code: "1" for bulk, "2" for embossed taping

Part No.	Varistor Voltage	Maximum Allowable Voltage		Clamping Voltage at Ip (max.)		Rated Power (W)	Maximum Energy (2 ms) (J)	Maximum Peak Current (8/20 μs, 2 times) (A)
	V <sub>1mA</sub> (V)	ACrms (V)	DC (V)	V <sub>CA</sub> (V)	I <sub>p</sub> (A)			
ERZSF□MK220	22 ( 20- 25)	14	18	43	2.5	0.02	0.9	125
ERZSF□MK270	27 ( 24- 30)	17	22	53	2.5	0.02	1.0	125
ERZSF□MK330	33 ( 30- 36)	20	26	65	2.5	0.02	1.2	125
ERZSF□MK390	39 ( 35- 43)	25	31	77	2.5	0.02	1.5	125
ERZSF□MK470	47 ( 42- 52)	30	38	93	2.5	0.02	1.8	125
ERZSF□MK560	56 ( 50- 62)	35	45	110	2.5	0.02	2.2	125
ERZSF□MK680	68 ( 61- 75)	40	56	135	2.5	0.02	2.5	125
ERZSF□MK820	82 ( 74- 90)	50	65	135	10	0.25	3.5	600
ERZSF□MK101	100 ( 90-110)	60	85	165	10	0.25	4.0	600
ERZSF□MK121	120 (108-132)	75	100	200	10	0.25	5.0	600
ERZSF□MK151	150 (135-165)	95	125	250	10	0.25	6.0	600
ERZSF□MK201	200 (185-225)	130	170	340	10	0.25	8.0	600
ERZSF□MK221	220 (198-242)	140	180	360	10	0.25	9.0	600
ERZSF□MK241	240 (216-264)	150	200	395	10	0.25	10.0	600
ERZSF□MK271	270 (247-303)	175	225	455	10	0.25	12.0	600
ERZSF□MK361	360 (324-396)	230	300	595	10	0.20	12.0	400
ERZSF□MK391	390 (351-429)	250	320	650	10	0.20	12.0	400
ERZSF□MK431	430 (387-473)	275	350	710	10	0.20	14.0	400
ERZSF□MK471	470 (423-517)	300	385	775	10	0.20	14.0	400

⌞ Packaging Style Code: "1" for bulk, "2" for embossed taping

Design and specifications are subject to change without notice. Ask factory for technical specifications before purchase and/or use. Whenever a doubt about safety arises from this product, please contact us immediately for technical consultation.

■ Typical Characteristics

■ Voltage vs. Current

■ ERZCF1 (2) MK220 to ERZCF1 (2) MK680

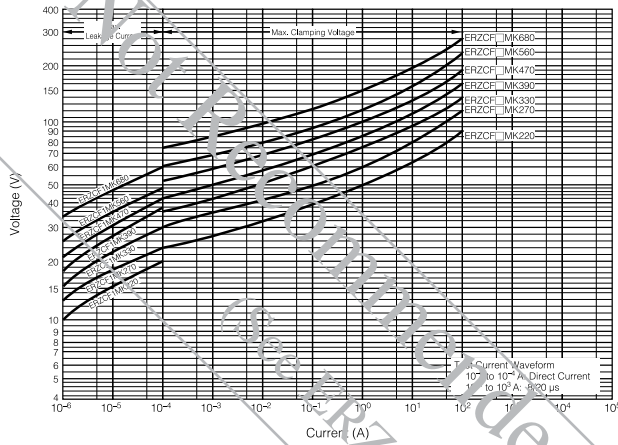

■ Impulse

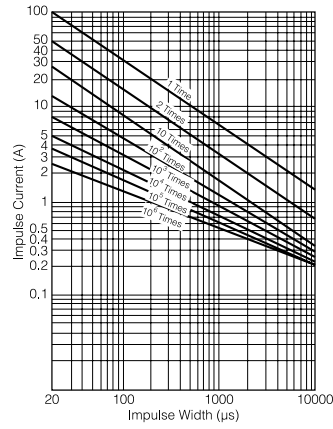

■ ERZCF1 (2) MK820 to ERZCF1 (2) MK471

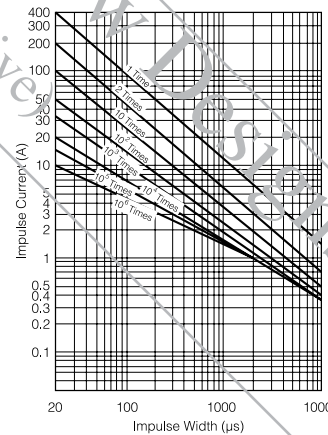
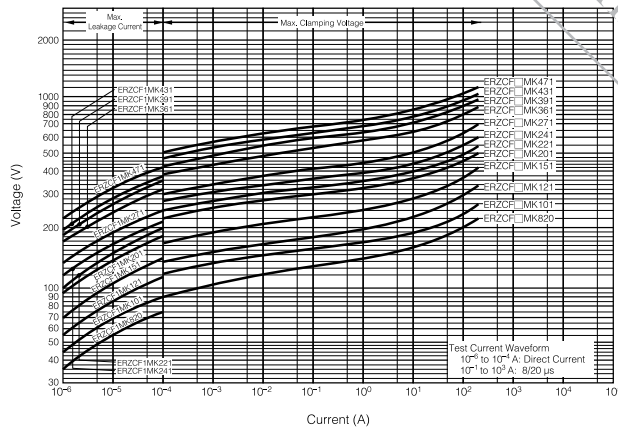

Design and specifications are subject to change without notice. Ask factory for technical specifications before purchase and/or use.  
Whenever a doubt about safety arises from this product, please contact us immediately for technical consultation.

■ Typical Characteristics

■ Voltage vs. Current

■ ERZSF1 (2) MK220 to ERZSF1 (2) MK680

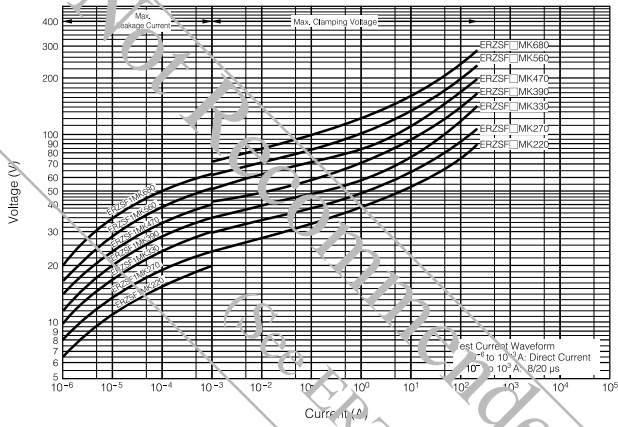

■ Impulse

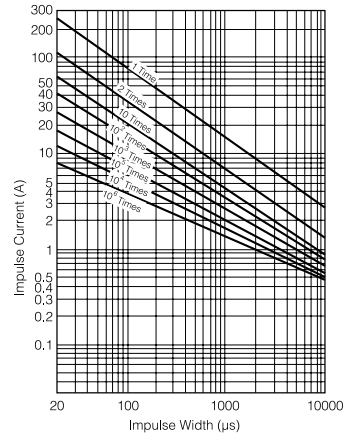

■ ERZSF1 (2) MK820 to ERZSF1 (2) MK471

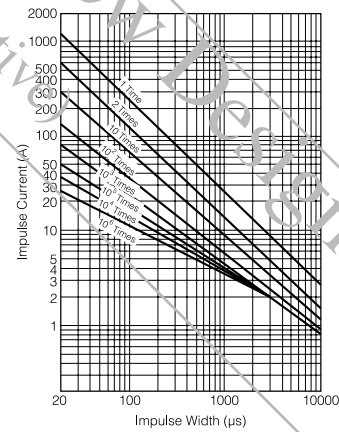
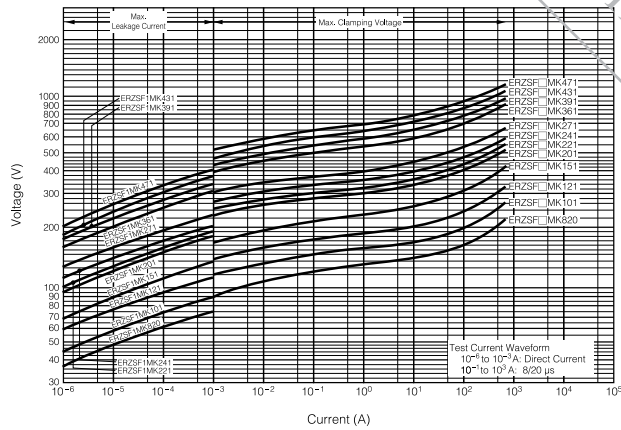

Design and specifications are subject to change without notice. Ask factory for technical specifications before purchase and/or use.  
Whenever a doubt about safety arises from this product, please contact us immediately for technical consultation.

### ■ Marking Contents

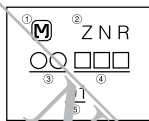

① Trade Mark	Trade Mark
② Product Name	ZNR
③ Type	CF Type:FK, SF Type:SF
④ Abbreviation of Part No.	The first two digits are significant figures and the third one denotes the number of zeros following.
⑤ Date Code	Left(Year): 2000:0, 2001:A, 2002:B, 2003:C, 2004:D, 2005:E Right(Month): Jan. to Sep.:1 to 9, Oct.:0, Nov.:N, Dec.:D

### ■ Packaging Specifications

#### ● Packing Quantity

Size Code	Thickness (mm)	Style	
		Embossed taping	Bulk
"CF", "SF"	3.2±0.3	2000 pcs./reel	200 pcs./bag

#### ● Reel

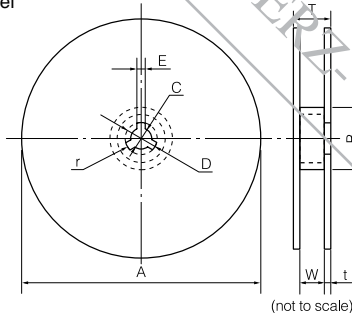

Dimensions (mm)	A	B	C	D	E
	382 max.	50 min.	13.0±0.5	21.0±0.8	2.0±0.5

Dimensions (mm)	W	T	t	r
	16.4 <sup>+2.0</sup> <sub>0</sub>	22.4 max.	2.5±0.5	1.0

#### ● Embossed Taping

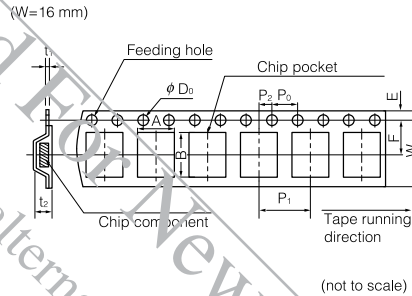

Dimensions (mm)	A	B	W	F	E	P <sub>1</sub>
	6.8±0.2	11.9 max.	16.0±0.3	7.5±0.1	1.75±0.10	8.0±0.1

Dimensions (mm)	P <sub>2</sub>	P <sub>0</sub>	φD <sub>0</sub>	t <sub>1</sub>	t <sub>2</sub>
	2.0±0.1	4.0±0.1	1.5 <sup>+0.1</sup> <sub>0</sub>	0.6 max.	6.3 max.

Design and specifications are subject to change without notice. Ask factory for technical specifications before purchase and/or use.  
Whenever a doubt about safety arises from this product, please contact us immediately for technical consultation.

■ Performance Characteristics

Characteristics	Test Methods	Specifications																					
Standard Test Condition	Electrical measurements (initial/after tests) shall be conducted at temperature of 5 to 35 °C, relative humidity of maximum 85 %	—																					
Varistor Voltage	The voltage between two terminals with the specified measuring current $I_{CmA}$ DC applied is called $V_C$ or $V_{CmA}$ . The measurement shall be made as fast as possible to avoid heat affection.	To meet the specified value.																					
Maximum Allowable Voltage	The recommended maximum sinusoidal wave voltage (rms) or the maximum DC voltage that can be applied continuously.																						
Clamping Voltage	The maximum voltage between two terminals with the specified impulse current (8/20 $\mu$ s).																						
Rated Power	The maximum power that can be applied within the specified ambient temperature.																						
Maximum Energy	Maximum energy at less than $\pm 10$ % of varistor voltage change when the standard impulse (2 ms) is applied one time.																						
Maximum Peak Current	Maximum current at less than $\pm 10$ % of varistor voltage change when impulse current (8/20 $\mu$ s) is applied two times continuously with the interval of 5 minutes.																						
Temperature Coefficient of Varistor Voltage	$\frac{V_{CmA} \text{ at } 85^\circ\text{C} - V_{CmA} \text{ at } 25^\circ\text{C}}{V_{CmA} \text{ at } 25^\circ\text{C}} \times \frac{1}{60} \times 100 (\%/^\circ\text{C})$		0 to $-0.05$ %/ $^\circ\text{C}$																				
Impulse Life (I)	<p>The change of <math>V_C</math> shall be measured after the specified impulse is applied 10000 times continuously with the interval of 10 seconds at room temperature.</p> <table border="1"> <thead> <tr> <th>Type</th> <th>Part Number</th> <th>Waveform</th> <th>Current</th> </tr> </thead> <tbody> <tr> <td rowspan="2">CF</td> <td>ERZCF1MK220 to ERZCF1MK680</td> <td>2 ms</td> <td>0.5 A</td> </tr> <tr> <td>ERZCF1MK820 to ERZCF1MK471</td> <td>8/20 <math>\mu</math>s</td> <td>20 A</td> </tr> <tr> <td rowspan="3">SF</td> <td>ERZSF1MK220 to ERZSF1MK680</td> <td>8/20 <math>\mu</math>s</td> <td>18 A</td> </tr> <tr> <td>ERZSF1MK820 to ERZSF1MK271</td> <td>8/20 <math>\mu</math>s</td> <td>50 A</td> </tr> <tr> <td>ERZSF1MK361 to ERZSF1MK471</td> <td>8/20 <math>\mu</math>s</td> <td>40 A</td> </tr> </tbody> </table>	Type	Part Number	Waveform	Current	CF	ERZCF1MK220 to ERZCF1MK680	2 ms	0.5 A	ERZCF1MK820 to ERZCF1MK471	8/20 $\mu$ s	20 A	SF	ERZSF1MK220 to ERZSF1MK680	8/20 $\mu$ s	18 A	ERZSF1MK820 to ERZSF1MK271	8/20 $\mu$ s	50 A	ERZSF1MK361 to ERZSF1MK471	8/20 $\mu$ s	40 A	$\Delta V_{CmA}/V_{CmA} \leq \pm 10$ %
Type	Part Number	Waveform	Current																				
CF	ERZCF1MK220 to ERZCF1MK680	2 ms	0.5 A																				
	ERZCF1MK820 to ERZCF1MK471	8/20 $\mu$ s	20 A																				
SF	ERZSF1MK220 to ERZSF1MK680	8/20 $\mu$ s	18 A																				
	ERZSF1MK820 to ERZSF1MK271	8/20 $\mu$ s	50 A																				
	ERZSF1MK361 to ERZSF1MK471	8/20 $\mu$ s	40 A																				
Impulse Life (II)	<p>The change of <math>V_C</math> shall be measured after the specified impulse is applied 100000 times continuously with the interval of 10 seconds at room temperature.</p> <table border="1"> <thead> <tr> <th>Type</th> <th>Part Number</th> <th>Waveform</th> <th>Current</th> </tr> </thead> <tbody> <tr> <td rowspan="2">CF</td> <td>ERZCF1MK220 to ERZCF1MK680</td> <td>2 ms</td> <td>0.45 A</td> </tr> <tr> <td>ERZCF1MK820 to ERZCF1MK471</td> <td>8/20 <math>\mu</math>s</td> <td>14 A</td> </tr> <tr> <td rowspan="3">SF</td> <td>ERZSF1MK220 to ERZSF1MK680</td> <td>8/20 <math>\mu</math>s</td> <td>12 A</td> </tr> <tr> <td>ERZSF1MK820 to ERZSF1MK271</td> <td>8/20 <math>\mu</math>s</td> <td>35 A</td> </tr> <tr> <td>ERZSF1MK361 to ERZSF1MK471</td> <td>8/20 <math>\mu</math>s</td> <td>28 A</td> </tr> </tbody> </table>	Type	Part Number	Waveform	Current	CF	ERZCF1MK220 to ERZCF1MK680	2 ms	0.45 A	ERZCF1MK820 to ERZCF1MK471	8/20 $\mu$ s	14 A	SF	ERZSF1MK220 to ERZSF1MK680	8/20 $\mu$ s	12 A	ERZSF1MK820 to ERZSF1MK271	8/20 $\mu$ s	35 A	ERZSF1MK361 to ERZSF1MK471	8/20 $\mu$ s	28 A	$\Delta V_{CmA}/V_{CmA} \leq \pm 10$ %
Type	Part Number	Waveform	Current																				
CF	ERZCF1MK220 to ERZCF1MK680	2 ms	0.45 A																				
	ERZCF1MK820 to ERZCF1MK471	8/20 $\mu$ s	14 A																				
SF	ERZSF1MK220 to ERZSF1MK680	8/20 $\mu$ s	12 A																				
	ERZSF1MK820 to ERZSF1MK271	8/20 $\mu$ s	35 A																				
	ERZSF1MK361 to ERZSF1MK471	8/20 $\mu$ s	28 A																				

Design and specifications are subject to change without notice. Ask factory for technical specifications before purchase and/or use. Whenever a doubt about safety arises from this product, please contact us immediately for technical consultation.