

### 10 Series

#### ■ Ratings and Characteristics

● Operating Temperature Range : -40 to 85 °C ● Storage Temperature Range : -40 to 125 °C

Part No.	Varistor Voltage	Maximum Allowable Voltage		Clamping Voltage (max.) **I <sub>p</sub>	Rated Power	Maximum Energy		Maximum Peak Current (8/20 μs)		Capacitance (max.) @1 kHz (pF)
						(10/1000 μs)	(2 ms)	1 time	2 times	
						V <sub>1 mA</sub> (V)	ACrms (V)	DC (V)	(V)	
ERZV10D180	18(16 to 20)	11	14	36	0.05	2.6	2.2	1000	500	16000
ERZV10D220	22(20 to 24)	14	18	43	0.05	3.2	2.6	1000	500	11000
ERZV10D270	27(24 to 30)	17	22	53	0.05	3.9	3.2	1000	500	8000
ERZV10D330	33(30 to 36)	20	26	65	0.05	4.8	4.0	1000	500	6300
ERZV10D390	39(35 to 43)	25	31	77	0.05	5.6	4.7	1000	500	5200
ERZV10D470	47(42 to 52)	30	38	93	0.05	6.8	5.6	1000	500	4600
ERZV10D560	56(50 to 62)	35	45	110	0.05	8.1	6.7	1000	500	3750
ERZV10D680	68(61 to 75)	40	56	135	0.05	9.8	8.2	1000	500	2800
ERZV10D820	82(74 to 90)	50	65	135	0.4	14	10	3500	2500	2000
ERZV10D101	100(90 to 110)	60	85	165	0.4	17	12	3500	2500	1700
ERZV10D121	120(108 to 132)	75	100	200	0.4	20	14.5	3500	2500	1400
ERZV10D151	150(135 to 165)	95	125	250	0.4	25	18	3500	2500	1100
ERZV10D201	200(185 to 225)	130	170	340	0.4	35	25	3500	2500	430
ERZV10D221	220(198 to 242)	140	180	360	0.4	39	27.5	3500	2500	410
ERZV10D241	240(216 to 264)	150	200	395	0.4	42	30	3500	2500	380
ERZV10D271	270(247 to 303)	175	225	455	0.4	49	35	3500	2500	350
ERZV10D331	330(297 to 363)	210	270	545	0.4	58	42	3500	2500	300
ERZV10D361	360(324 to 396)	230	300	595	0.4	65	45	3500	2500	300
ERZV10D391	390(351 to 429)	250	320	650	0.4	70	50	3500	2500	300
ERZV10D431	430(387 to 473)	275	350	710	0.4	80	55	3500	2500	270
ERZV10D471	470(423 to 517)	300	385	775	0.4	85	60	3500	2500	230
ERZV10D511	510(459 to 561)	320	410	845	0.4	92	67	3500	2500	210
ERZV10D621	620(558 to 682)	385	505	1025	0.4	92	67	3500	2500	190
ERZV10D681	680(612 to 748)	420	560	1120	0.4	92	67	3500	2500	170
ERZV10D751	750(675 to 825)	460	615	1240	0.4	100	70	3500	2500	160
ERZV10D821	820(738 to 902)	510	670	1355	0.4	110	80	3500	2500	140
ERZV10D911	910(819 to 1001)	550	745	1500	0.4	130	90	3500	2500	120
ERZV10D102	1000(900 to 1100)	625	825	1650	0.4	140	100	3500	2500	110
ERZV10D112	1100(990 to 1210)	680	895	1815	0.4	155	110	3500	2500	110
ERZV10D182CS	1800(1700 to 1980)	1000	1465	2970	0.4	247	183	3500	2500	70*

\* Measured at 1 MHz \*\*I<sub>p</sub> Measuring current of clamping voltage 180 to 680 : 5 A, 820 to 182 : 25 A

■ Dimensions in mm (not to scale) \* Refer to page 99 to 100 about leads cut type and taping.

Part No.	D max.	T max.	W±1.0	H max.	L±1.0
ERZV10D180	11.5	4.6	7.5	14.5	1.3
ERZV10D220	11.5	4.7	7.5	14.5	1.4
ERZV10D270	11.5	4.8	7.5	14.5	1.5
ERZV10D330	11.5	5.0	7.5	14.5	1.7
ERZV10D390	11.5	4.9	7.5	14.5	1.6
ERZV10D470	11.5	5.0	7.5	14.5	1.7
ERZV10D560	11.5	5.1	7.5	14.5	1.8
ERZV10D680	11.5	5.3	7.5	14.5	2.0
ERZV10D820	11.5	4.5	7.5	14.5	1.6
ERZV10D101	11.5	4.7	7.5	14.5	1.8
ERZV10D121	11.5	4.9	7.5	14.5	2.0
ERZV10D151	11.5	5.2	7.5	14.5	2.3
ERZV10D201	11.5	4.8	7.5	14.5	1.9
ERZV10D221	11.5	4.9	7.5	14.5	2.0
ERZV10D241	11.5	5.0	7.5	14.5	2.1
ERZV10D271	11.5	5.2	7.5	14.5	2.3
ERZV10D331	11.5	5.5	7.5	14.5	2.6
ERZV10D361	11.5	5.7	7.5	14.5	2.8
ERZV10D391	11.5	5.8	7.5	14.5	2.9
ERZV10D431	11.5	6.0	7.5	14.5	3.1
ERZV10D471	11.5	6.2	7.5	14.5	3.3
ERZV10D511	11.5	6.4	7.5	14.5	3.5
ERZV10D621	12.5	7.1	7.5	15.5	4.2
ERZV10D681	12.5	7.4	7.5	15.5	4.5
ERZV10D751	12.5	7.8	7.5	15.5	4.9
ERZV10D821	12.5	8.1	7.5	15.5	5.2
ERZV10D911	12.5	8.6	7.5	15.5	5.7
ERZV10D102	12.5	9.1	7.5	15.5	6.2
ERZV10D112	12.5	9.7	7.5	15.5	6.8
ERZV10D182CS	13.5	14.4	11.0*	16.5	10.0(±1.5)

\*: W<sub>2</sub>

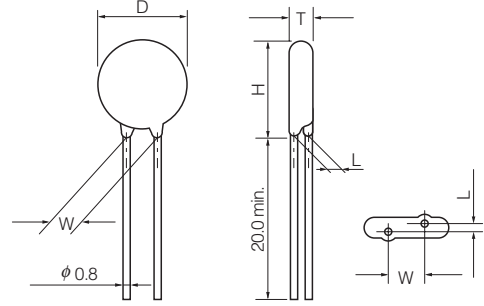

(ERZV10D182CS)

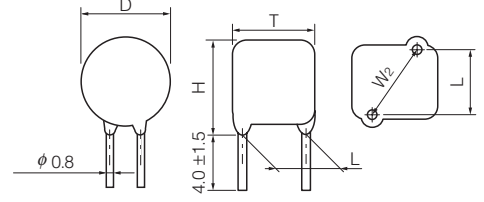

### ■ Typical Characteristics Voltage vs. Current

ERZV10D180 to ERZV10D680

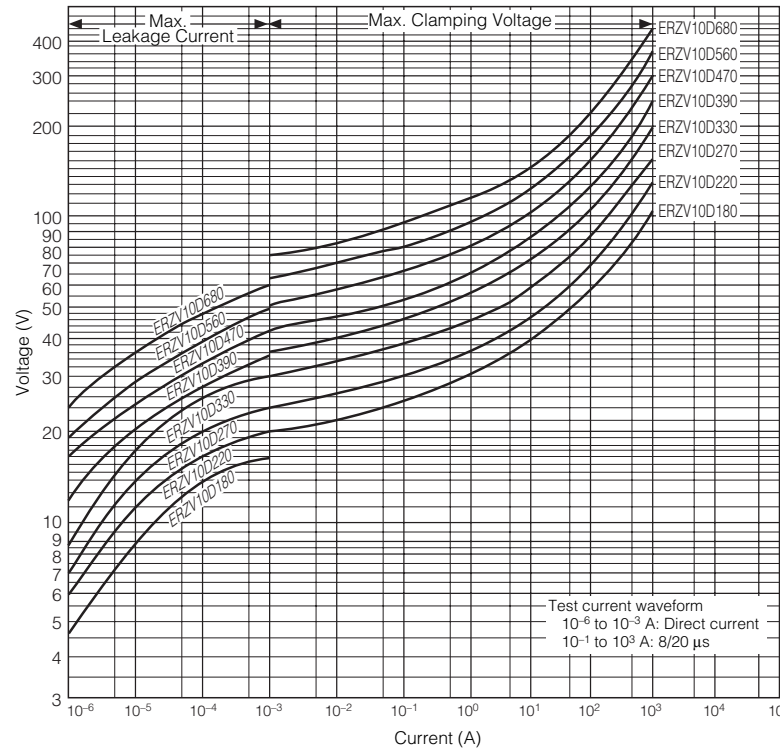

### Impulse Derating (Relation between impulse width and impulse current multiple)

ERZV10D180 to ERZV10D680

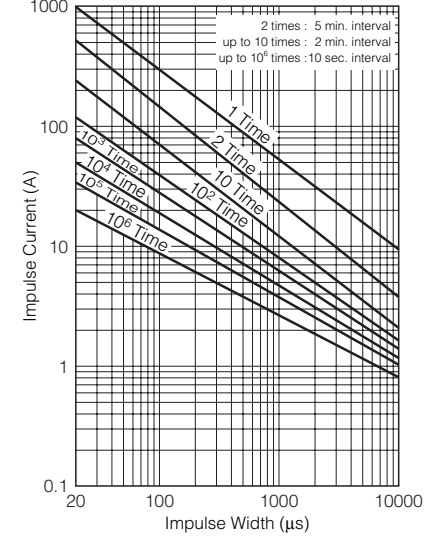

Design and specifications are each subject to change without notice. Ask factory for the current technical specifications before purchase and/or use. Should a safety concern arise regarding this product, please be sure to contact us immediately.

### Typical Characteristics Voltage vs. Current

ERZV10D820 to ERZV10D511

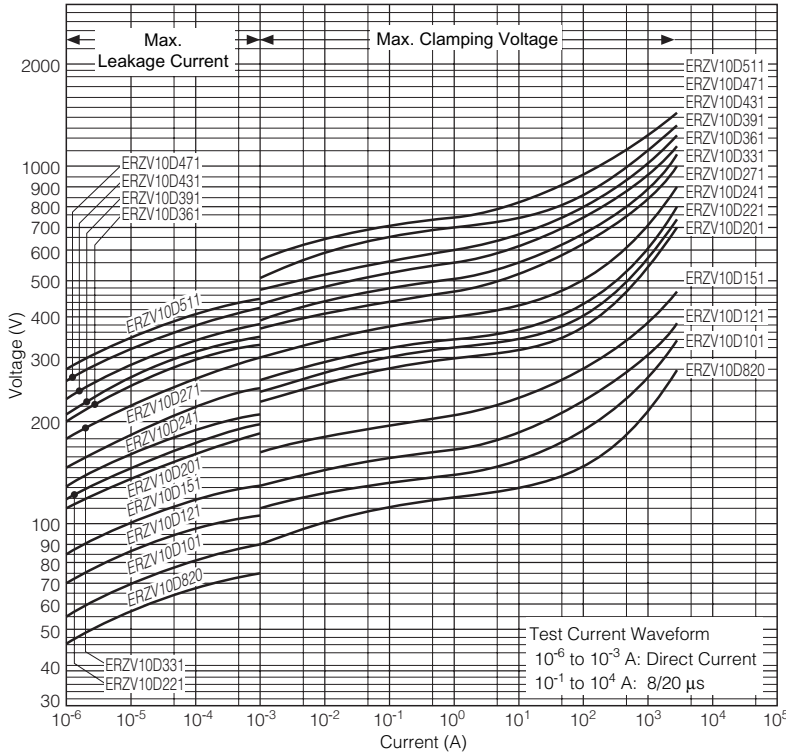

### Impulse Derating (Relation between impulse width and impulse current multiple)

ERZV10D820 to ERZV10D511

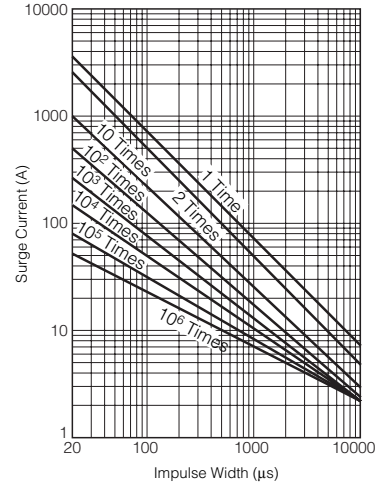

ERZV10D621 to ERZV10D112

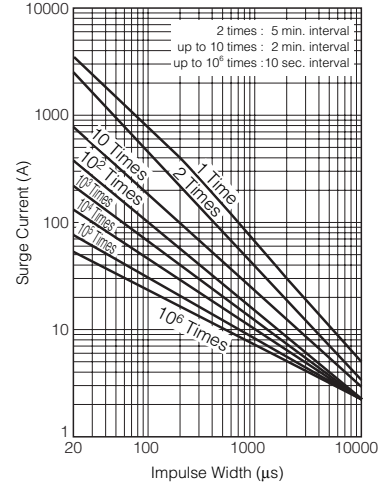

ERZV10D621 to ERZV10D182CS

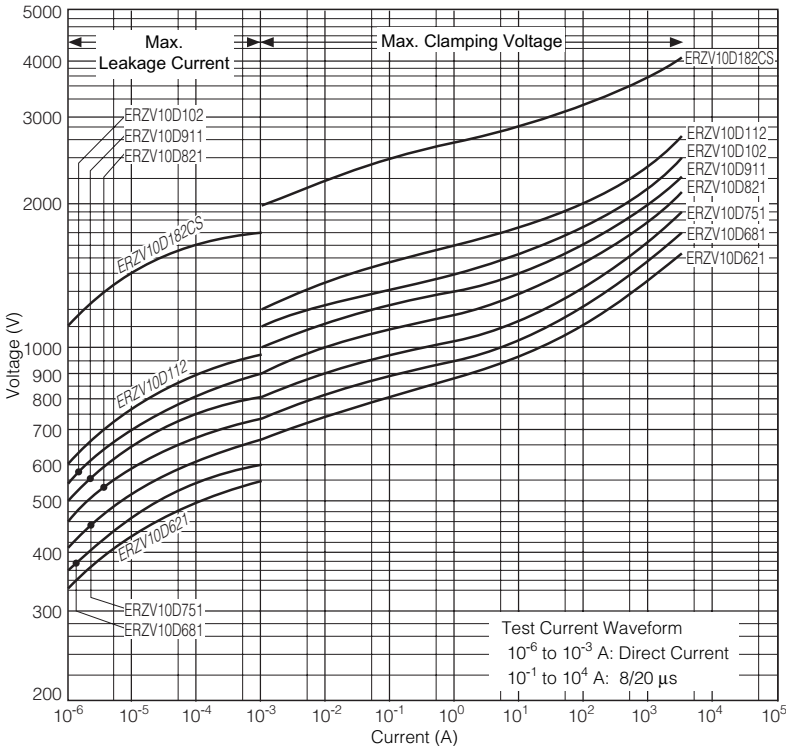

ERZV10D182CS

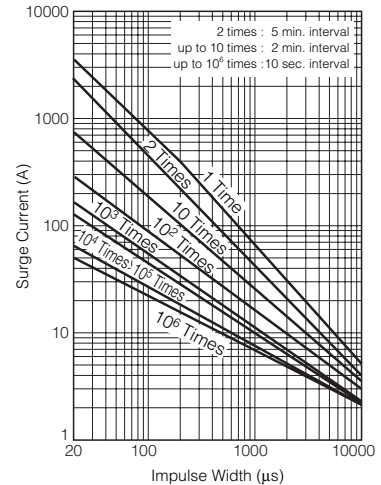

"ZNR" Transient/Surge Absorbers

Design and specifications are each subject to change without notice. Ask factory for the current technical specifications before purchase and/or use. Should a safety concern arise regarding this product, please be sure to contact us immediately.