

### GENERAL DESCRIPTION

The ROV10-XXX (Radial-leaded Metal Oxide Varistor) products are 10mm radial leaded varistor devices suitable for protection of overvoltage transients.

ROV devices can provide protection for a wide variety of power systems against overvoltage faults such as lightning, power contact and power induction. Suitable for a broad range of applications including, but not limited to security, power supplies, surge strips, etc., the ROV device helps to protect valuable equipment from potential power surge damage by clamping high energy, short duration impulses. The ROV devices have high current handling and energy absorption capability and fast response times to help protect against transient faults.

### FEATURES

- Radial leaded
- Broad Varistor voltage and  $V_{rms}$  range
  - Varistor voltage : 18V - 1800V
  - $V_{rms}$  voltage : 11V - 1000V
- Two surge capability series
  - Standard series, High surge series
- Various lead types
  - Straight, Kinked, Other
- Various packaging options
  - Bulk, Tape & Reel, Ammo Pack
- Helps designers meet the following standards
  - UL, CSA, VDE
- Fast response time
- High current and energy absorption capability

### APPLICATIONS

- Power supplies and power systems
- Line voltage
- Telecommunications systems
- Automotive systems
- Appliances

### TYPICAL APPLICATION SCHEMATIC

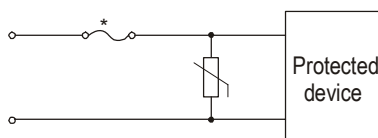

\*In some applications, a polymeric PTC device such as a Tyco Electronics PolySwitch device may be used instead of a fuse to provide a preferred solution.

### MATERIALS INFORMATION

RoHS Compliant

ELV Compliant

Directive 2002/95/EC  
Compliant

Directive 2000/53/EC  
Compliant

\*After May 1, 2005 all ROV devices will be produced as RoHS compliant devices.

## PART NUMBERING

**ROV 10 - 241 K -S -2**

**Manufacturer series**

**Disk Diameter**  
10mm

**Surge series**

- : Standard Series  
H : High Surge Series

**Varistor Voltage**

241 =  $24 \times 10^1 = 240V$

**Packaging**

: Bulk  
-2 : Tape & Reel  
-AP : Ammo Pack

**Lead Type**

: Kinked Lead  
-S : Straight Lead

**Tolerance**

K :  $\pm 10\%$   
L :  $\pm 15\%$   
M :  $\pm 20\%$

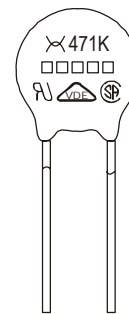
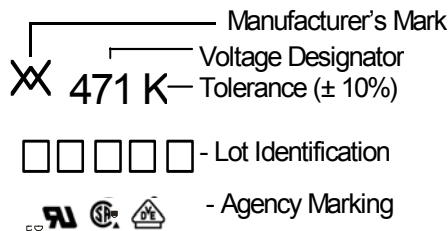

### **Lot Identification**

RoHS compliant devices: 4 characters

Non RoHS compliant devices: 5 characters with M at the end.

## GENERAL CHARACTERISTICS

Storage temperature:	-40°C ... +125°C
Maximum operating temperature:	-40°C ... + 85°C
Maximum working surface temperature:	+115°C
Temperature coefficient of voltage:	0 ... +0.05% / °C max.
Insulation resistance of coating (@ 500 VDC):	Over 1000MΩ
Maximum response time:	25ns
Lead Material:	22 AWG Sn Plated Copper

## AGENCY RECOGNITION

Device Ratings and Characteristics Tables contain specific recognition information for each individual part. The table below details marking symbols for each agency recognition type.

UL1414	UL1449 (2nd Edition)	CSA	VDE
◆	●	▲	■

### DEVICE RATINGS AND CHARACTERISTICS

#### STANDARD SERIES

Part Number	Varistor Voltage V@1.0mA		Maximum Allowable Voltage		Maximum Clamping Voltage V@25A	Maximum Surge Current (8x20us)		Rated Wattage	Energy (10x1000us)	Capacitance (Typical)	Certifications
	(V <sub>DC</sub> )	Tolerance	V <sub>rms</sub> (V <sub>AC</sub> )	(V <sub>DC</sub> )	(V <sub>DC</sub> )	1 Time (A)	2 Times (A)	(W)	(J)	@1kHz (pF)	
ROV10-180M	18	± 20%	11	14	36 <sup>1)</sup>	500	250	0.05	2.4	6500	● ■
ROV10-220L	22	± 15%	14	18	43 <sup>1)</sup>				2.7	5521	● ■
ROV10-270K	27	± 10%	17	22	53 <sup>1)</sup>				3.5	4742	● ■
ROV10-330K	33		20	26	65 <sup>1)</sup>				4.4	4247	● ■
ROV10-390K	39		25	31	77 <sup>1)</sup>				4.7	3658	● ■
ROV10-470K	47		30	38	93 <sup>1)</sup>				6.0	3137	● ■
ROV10-560K	56		35	45	110 <sup>1)</sup>				7.0	2900	● ■
ROV10-680K	68		40	56	135 <sup>1)</sup>				8.5	2230	● ■
ROV10-820K	82		50	65	135				11.0	1261	● ■
ROV10-101K	100		60	85	165				14.0	1021	● ■
ROV10-121K	120		75	100	200	16.0	946	● ■			
ROV10-151K	150		95	125	250	22.0	733	● ■			
ROV10-181K	180	115	150	300	26.0	483	● ■				
ROV10-201K	200	130	170	340	28.5	400	◆ ● ▲ ■				
ROV10-221K	220	140	180	360	31.0	393	◆ ● ▲ ■				
ROV10-241K	240	150	200	395	33.5	325	◆ ● ▲ ■				
ROV10-271K	270	175	225	455	39.5	334	◆ ● ▲ ■				
ROV10-301K	300	195	250	505	42.0	278	◆ ● ▲ ■				
ROV10-331K	330	210	275	550	46.0	275	◆ ● ▲ ■				
ROV10-361K	360	230	300	595	52.0	231	◆ ● ▲ ■				
ROV10-391K	390	250	320	650	60.0	247	◆ ● ▲ ■				
ROV10-431K	430	275	350	710	66.0	216	◆ ● ▲ ■				
ROV10-471K	470	300	385	775	70.0	210	◆ ● ▲ ■				
ROV10-511K	510	320	418	842	74.0	187	◆ ● ▲ ■				
ROV10-561K	560	350	460	920	78.0	186	◆ ● ▲ ■				
ROV10-621K	620	385	505	1025	82.0	160	◆ ● ▲ ■				
ROV10-681K	680	420	560	1120	86.0	156	◆ ● ▲ ■				
ROV10-751K	750	460	615	1240	90.0	133	◆ ● ▲ ■				
ROV10-781K	780	485	640	1290	92.0	117	◆ ● ▲ ■				
ROV10-821K	820	510	670	1355	94.0	130	◆ ● ▲ ■				
ROV10-911K	910	550	745	1500	102.0	111	◆ ● ▲ ■				
ROV10-102K	1000	625	825	1650	112.0	96	◆ ● ▲ ■				
ROV10-112K	1100	680	895	1815	124.0	88	◆ ● ▲ ■				
ROV10-182K	1800	1000	1465	2970	174.0	65	◆ ● ▲ ■*				

\* Pending VDE Recognition

1) The clamping voltage for devices ROV10-180M to ROV10-680K is tested with 5A current.

**PULSE LIFETIME RATING CURVES**

**STANDARD SERIES**  
**ROV10-180M – ROV10-680K**

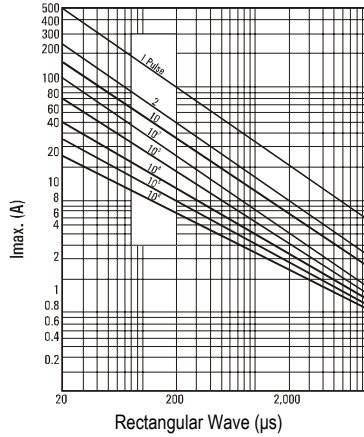

**V-I CHARACTERISTIC CURVES**

**STANDARD SERIES**  
**ROV10-180M – ROV10-680K**

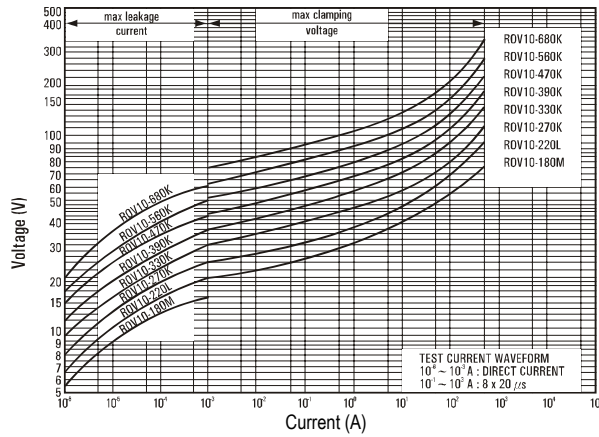

**ROV10-820K – ROV10-511K**

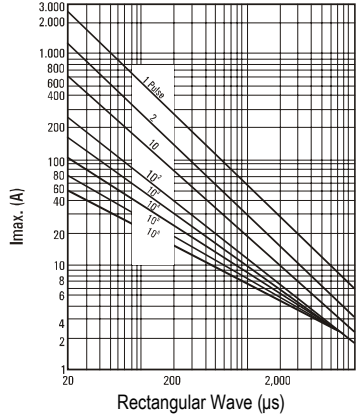

**ROV10-820K – ROV10-511K**

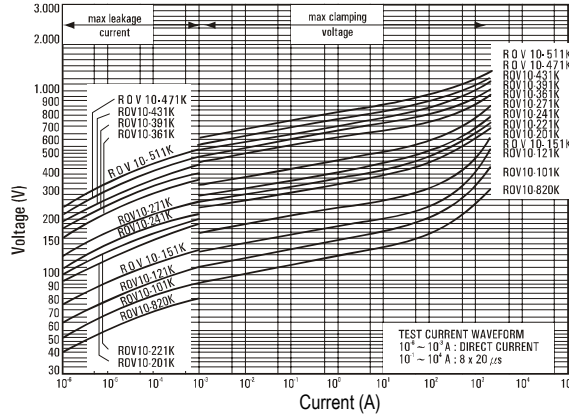

**ROV10-561K – ROV10-182K**

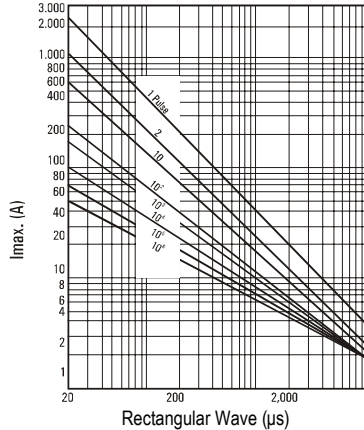

**ROV10-561K – ROV10-182K**

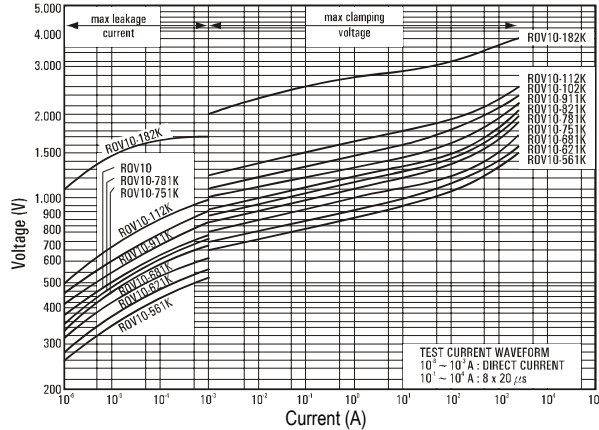

### DEVICE RATINGS AND CHARACTERISTICS

#### HIGH SURGE SERIES

Part Number	Varistor Voltage V@1.0mA		Maximum Allowable Voltage		Maximum Clamping Voltage V@25A	Maximum Surge Current (8x20us)		Rated Wattage (W)	Energy (10x1000us) (J)	Capacitance (Typical) @1kHz (pF)	Certifications 
	(V <sub>DC</sub> )	Tolerance	V <sub>rms</sub> (V <sub>AC</sub> )	(V <sub>DC</sub> )	(V <sub>DC</sub> )	1 Time (A)	2 Times (A)				
ROV10H180M	18	± 20%	11	14	36 <sup>1)</sup>	1000	500	0.05	2.6	6500	● ■
ROV10H220L	22	± 15%	14	18	43 <sup>1)</sup>				3.2	5520	● ■
ROV10H270K	27	± 10%	17	22	53 <sup>1)</sup>				3.9	4740	● ■
ROV10H330K	33		20	26	65 <sup>1)</sup>				4.8	4250	● ■
ROV10H390K	39		25	31	77 <sup>1)</sup>				5.6	3660	● ■
ROV10H470K	47		30	38	93 <sup>1)</sup>				6.8	3140	● ■
ROV10H560K	56		35	45	110 <sup>1)</sup>				8.1	2900	● ■
ROV10H680K	68		40	56	135 <sup>1)</sup>				9.8	2230	● ■
ROV10H820K	82		50	65	135				14.0	1260	● ■
ROV10H101K	100		60	85	165				18.0	1020	● ■
ROV10H121K	120		75	100	200	22.0	950	● ■			
ROV10H151K	150		95	125	250	25.0	730	● ■			
ROV10H181K	180	115	150	300	32.0	480	● ■				
ROV10H201K	200	130	170	340	35.0	400	◆ ● ▲ ■				
ROV10H221K	220	140	180	360	39.0	390	◆ ● ▲ ■				
ROV10H241K	240	150	200	395	42.0	330	◆ ● ▲ ■				
ROV10H271K	270	175	225	455	49.0	330	◆ ● ▲ ■				
ROV10H301K	300	195	250	505	52.0	280	◆ ● ▲ ■				
ROV10H331K	330	210	275	550	58.0	280	◆ ● ▲ ■				
ROV10H361K	360	230	300	595	65.0	230	◆ ● ▲ ■				
ROV10H391K	390	250	320	650	70.0	250	◆ ● ▲ ■				
ROV10H431K	430	275	350	710	80.0	220	◆ ● ▲ ■				
ROV10H471K	470	300	385	775	85.0	210	◆ ● ▲ ■				
ROV10H511K	510	320	418	842	92.0	190	◆ ● ▲ ■				
ROV10H561K	560	350	460	920	102.0	190	◆ ● ▲ ■				
ROV10H621K	620	385	505	1025	107.0	160	◆ ● ▲ ■				
ROV10H681K	680	420	560	1120	112.0	160	◆ ● ▲ ■				
ROV10H751K	750	460	615	1240	115.0	130	◆ ● ▲ ■				
ROV10H781K	780	485	640	1290	116.0	120	◆ ● ▲ ■				
ROV10H821K	820	510	670	1355	118.0	130	◆ ● ▲ ■				
ROV10H911K	910	550	745	1500	127.0	110	◆ ● ▲ ■				
ROV10H102K	1000	625	825	1650	140.0	95	◆ ● ▲ ■				
ROV10H112K	1100	680	895	1815	155.0	90	◆ ● ▲ ■				

1) The clamping voltage for devices ROV10H180M to ROV10H680K is tested with 5A current.

**PULSE LIFETIME RATING CURVES**

**HIGH SURGE SERIES**

**ROV10H180M – ROV10H680K**

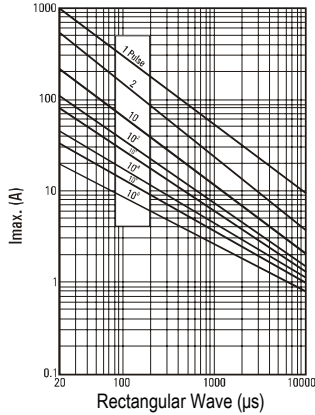

**ROV10H820K – ROV10H511K**

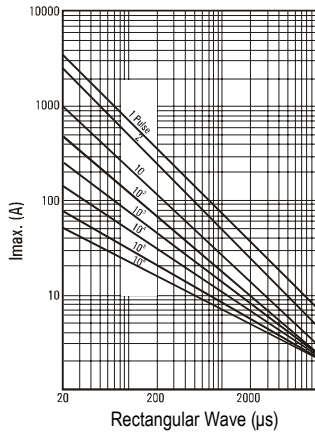

**ROV10H561K – ROV10H182K**

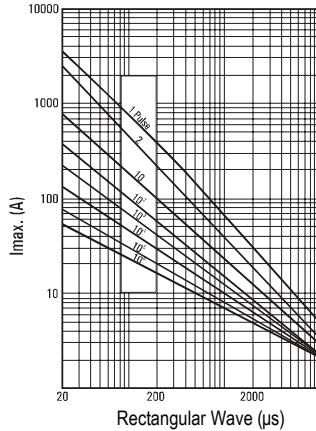

**V-I CHARACTERISTIC CURVES**

**HIGH SURGE SERIES**

**ROV10H180M – ROV10H680K**

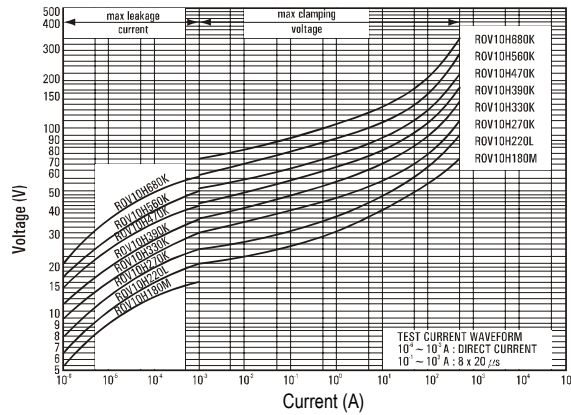

**ROV10H820K – ROV10H511K**

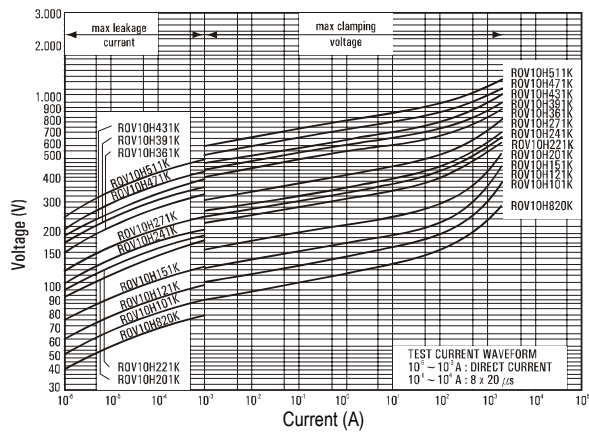

**ROV10H561K – ROV10H182K**

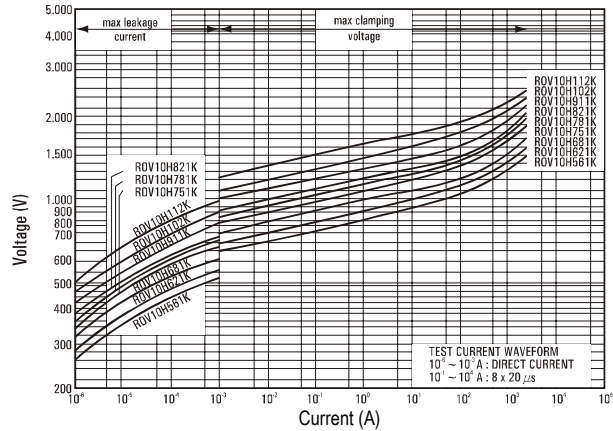

## DIMENSIONS

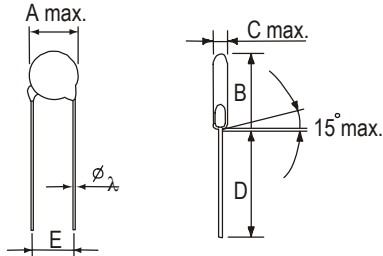

**KINKED LEAD TYPE**  
Dimension Table

A max.	12.5
$\lambda \pm 0.05$	0.8
$E \pm 1.0$	7.5
B max.	18.0
$D_1$ min.	25.0
D min.	24.0

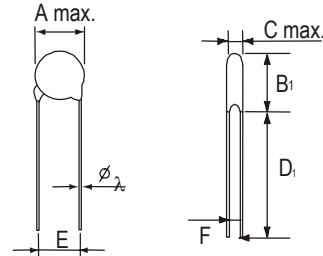

**STRAIGHT LEAD TYPE (-S)**  
Table of C max., F, and B<sub>1</sub> max.

Type No.	C max.	F±0.8	B <sub>1</sub> max.
180M	4.9	0.8	15.5
220L	4.9	0.9	15.5
270K	5.1	0.9	15.5
330K	5.1	1.0	15.5
390K	5.1	1.2	15.5
470K	5.5	1.2	15.5
560K	5.5	1.4	15.5
680K	6.0	1.7	15.5
820K	4.3	0.8	15.5
101K	4.4	0.8	15.5
121K	4.5	0.9	15.5
151K	4.9	1.2	15.5
181K	4.5	1.0	15.5
201K	4.6	1.0	15.5
221K	4.7	1.1	15.5
241K	4.8	1.3	15.5
271K	5.0	1.4	15.5
301K	5.2	1.6	15.5
331K	5.3	1.6	15.5
361K	5.5	1.9	15.5
391K	5.7	2.2	16.0
431K	6.5	2.5	16.0
471K	6.8	2.6	16.0
511K	7.0	3.1	16.5
561K	7.3	3.4	16.5
621K	7.6	4.0	16.5
681K	8.0	4.4	16.5
751K	8.4	4.4	16.5
781K	8.6	4.6	16.5
821K	8.8	4.6	16.5
911K	9.4	5.4	16.5
102K	9.9	5.4	16.5
112K	10.5	5.7	16.5
182K	12.6	9.8	18.5

## PACKAGING

in mm

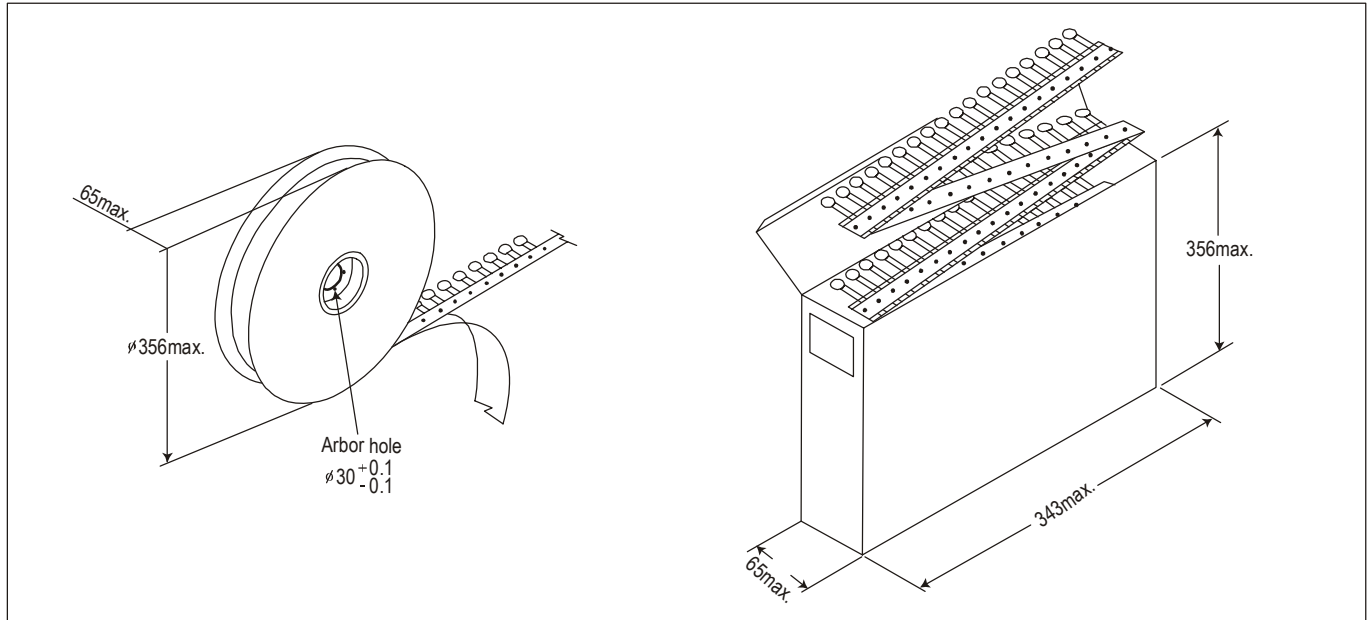

Packaging	Bulk (box)	Reel	Ammo
Box size (mm)	290 x 155 x 110	350 x 350 x 108	343 x 260 x 52
Carton size (mm)	310 x 328 x 250	371 x 371 x 590	363 x 540 x 250
One carton with	4 Boxes	5 Boxes (10 reels)	8 Boxes

Part Number	Bulk (box)	Reel	Ammo	
			F=7.5	F=5.0
ROV10-180M to ROV10-470K, ROV10H180M to ROV10H470K	2500	1000	500	1000
ROV10-560K to ROV10-680K, ROV10H 560K to ROV10H 680K	2500	1000	500	1000
ROV10-820K to ROV10-331K, ROV10H820K to ROV10H331K	2500	1000	500	1000
ROV10-361K to ROV10-391K, ROV10H361K to ROV10H391K	2500	1000	500	1000
ROV10-431K to ROV10-471K, ROV10H431K to ROV10H471K	2500	750	500	750
ROV10-511K to ROV10-751K, ROV10H511K to ROV10H751K	1500	500	500	500
ROV10-751K to ROV10-182K, ROV10H751K to ROV10H112K	1500	500	500	500



### TAPE AND REEL DIMENSIONS

1/2" Pitch

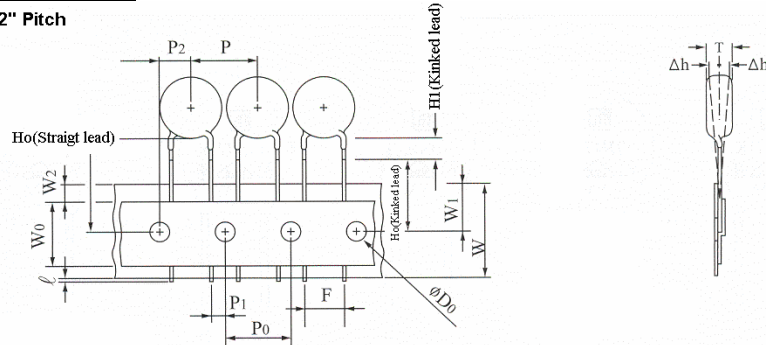

1.0" Pitch

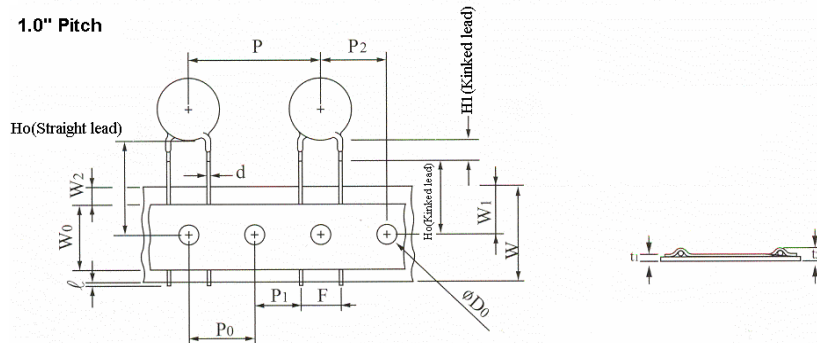

Symbols	Item	Value
$\lambda$	Cut out length	1.1mm max.
$H_1$ (Kinked lead)	Height of kink	5.0mm max.
$H_o$ (Kinked lead)	Height to seating plane	16.0 ± 0.5mm
$H_o$ (Straight lead)	Height of component from hole center	16.0-21.0mm
$\Delta h$	Front to back deviation	0.0 ± 2.0mm
$W$	Carrier tape width	18.0 $^{+1.0}_{-0.5}$ mm
$W_0$	Hold down tape width	10.0mm, 12.0mm
$W_1$	Sprocket hole position	9.0 $^{+0.75}_{-0.5}$ mm
$W_2$	Adhesive tape position	3.0mm max.
$F$	Component lead spacing	7.5 $^{+0.8}_{-0.2}$ mm, 5.0 $^{+0.8}_{-0.2}$ mm
$P$	Pitch of component	12.7 ± 1.0mm, 25.4 ± 1.0mm
$P_0$	Sprocket hole pitch	12.7 ± 0.3mm
$P_1$	Lead length from hole center to lead	3.85 ± 0.7mm, 8.95 ± 0.7mm
$P_2$	Length from hole center to disk center	6.35 ± 1.3mm, 12.7 ± 1.3mm
$D_0$	Sprocket hole diameter	4.0 ± 0.2mm
$d$	Lead wire diameter	0.6 ± 0.05mm, 0.8 ± 0.05mm
$T$	Disk thickness	See C. max table
$t_1$	Total thickness tape	0.7 ± 0.05mm
$t_2$	Total thickness	1.6mm max. , 1.8mm max



308 Constitution Drive  
Menlo Park, CA 94025-1164  
Phone: 800-227-4856  
www.circuitprotection.com

## Metal Oxide Varistors

Overvoltage Protection Device

*Raychem Circuit Protection Products*

**PRODUCT: ROV10, ROV10H**  
**10mm Series**

DOCUMENT: SCD 25482  
PCN:  
REV LETTER: D  
REV DATE: JULY 19, 2007  
PAGE NO.: 10 of 10

Information furnished is believed to be accurate and reliable. However, users should independently evaluate the suitability of each product for their applications. Tyco Electronics Corporation assumes no responsibility for the use of its product or for any infringement of patents or other rights of third parties resulting from the use of its product. No license is granted by implication or otherwise under any patent or proprietary right of Tyco Electronics except the right to use such product for the purpose for which it is sold. Tyco Electronics reserves the right to change or update, without notice, any information contained in this publication; to change, without notice, the design, construction, processing, or specification of any product; and to discontinue or limit production or distribution of any product. This publication supersedes and replaces all information previously supplied. Without expressed or written consent by an officer of Tyco Electronics, Tyco Electronics does not authorize the use of any of its products as components in nuclear facility applications, aerospace, or in critical life support devices or systems. Tyco Electronics' only obligations are those in the Tyco Electronics Standard Terms and Conditions of Sale and in no case will Tyco Electronics be liable for any incidental, indirect, or consequential damages arising from the sale, resale, use, or misuse of its products.

© 2007 Tyco Electronics Corporation. All rights reserved.