

## GENERAL DESCRIPTION

The ROV20-XXX (Radial-leaded Metal Oxide Varistor) products are 20mm radial leaded varistor devices suitable for protection of overvoltage transients.

ROV devices can provide protection for a wide variety of power systems against overvoltage faults such as lightning, power contact and power induction. Suitable for a broad range of applications including, but not limited to security, power supplies, surge strips, etc., the ROV device helps to protect valuable equipment from potential power surge damage by clamping high energy, short duration impulses. The ROV devices have high current handling and energy absorption capability and fast response times to help protect against transient faults.

## FEATURES

- Radial leaded
- Broad Varistor voltage and  $V_{rms}$  range
  - Varistor voltage : 22V – 68V; 100V - 1800V
  - $V_{rms}$  voltage : 14V – 40V; 60V - 1000V
- Three surge capability series
  - Standard series, High surge series, Extra high surge series
- Various lead types
  - Straight, Kinked, Other
- Various packaging options
  - Bulk, Tape & Reel, Ammo Pack
- Helps designers meet the following standards
  - UL, CSA, VDE
- Fast response time
- High current and energy absorption capability

## APPLICATIONS

- Power supplies and power systems
- Line voltage
- Telecommunications systems
- Automotive systems
- Appliances

## TYPICAL APPLICATION SCHEMATIC

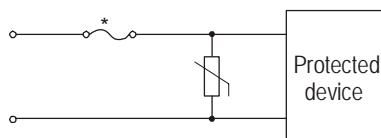

\*In some applications, a polymeric PTC device such as a Tyco Electronics PolySwitch device may be used instead of a fuse to provide a preferred solution.

## MATERIALS INFORMATION

RoHS Compliant

Directive 2002/95/EC  
Compliant

ELV Compliant

Directive 2000/53/EC  
Compliant

\*After May 1, 2005 all ROV devices will be produced as RoHS compliant devices.

308 Constitution Drive  
Menlo Park, CA 94025-1164  
Phone: 800-227-4856  
www.circuitprotection.com

*Raychem Circuit Protection Products*

DOCUMENT: SCD 25484  
PCN:  
REV LETTER: E  
REV DATE: JULY 19, 2007  
PAGE NO.: 2 of 13

### PART NUMBERING

**ROV 20 - 241 K -S -2**

**Manufacturer series**

**Disk Diameter**  
20mm

**Surge Series**

- : Standard series  
H : High surge series  
E : Extra high surge series

**Varistor Voltage**

241 =  $24 \times 10^1 = 240V$

**Packaging**

: Bulk  
-2 : Tape & Reel  
-AP : Ammo Pack

**Lead Type**

: Kinked Lead  
-S : Straight Lead

**Tolerance**

K :  $\pm 10\%$   
L :  $\pm 15\%$   
M :  $\pm 20\%$

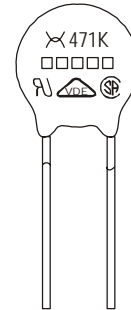
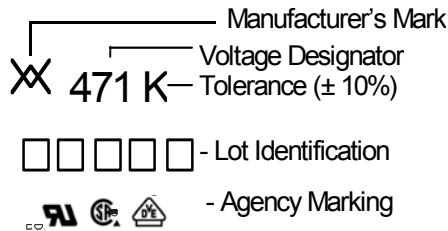

### Lot Identification

RoHS compliant devices: 4 characters  
Non RoHS compliant devices: 5 characters with M at the end.

### GENERAL CHARACTERISTICS

Storage temperature:	-40°C ... +125°C
Maximum operating temperature:	-40°C ... +85°C
Maximum working surface temperature:	+115°C
Temperature coefficient of voltage:	0 ... +0.05% / °C max.
Insulation resistance of coating (@ 500 V <sub>DC</sub> ):	Over 1000MΩ
Maximum response time:	25ns
Lead Material:	22AWG Sn Plated Copper

### AGENCY RECOGNITION

Device Ratings and Characteristics Tables contain specific recognition information for each individual part. The table below details marking symbols for each agency recognition type.

UL1414	UL1449 (2nd Edition)	CSA	VDE
◆	●	▲	■

### DEVICE RATINGS AND CHARACTERISTICS

#### STANDARD SERIES

Part Number	Varistor Voltage V@1.0mA		Maximum Allowable Voltage		Maximum Clamping Voltage V@100A	Maximum Surge Current (8x20us)		Rated Wattage (W)	Energy (10x1000us) (J)	Capacitance (Typical) @1kHz (pF)	Certifications 			
	(V <sub>DC</sub> )	Tolerance	V <sub>rms</sub> (V <sub>AC</sub> )	(V <sub>DC</sub> )	(V <sub>DC</sub> )	1 Time (A)	2 Times (A)							
ROV20-220M	22	± 20%	14	18	43 <sup>(1)</sup>	2000	1000	0.20	8.0	21200	● ■			
ROV20-270M	27		17	22	53 <sup>(1)</sup>				10.0	20000	● ■			
ROV20-330M	33		20	26	65 <sup>(1)</sup>				12.0	17200	● ■			
ROV20-390L	39	± 15%	25	31	77 <sup>(1)</sup>				6500	4000	1.00	14.0	15003	● ■
ROV20-470L	47		30	38	93 <sup>(1)</sup>							17.0	12080	● ■
ROV20-560L	56		35	45	110 <sup>(1)</sup>							20.0	11600	● ■
ROV20-680L	68		40	56	135 <sup>(1)</sup>							24.0	9600	● ■
ROV20-101K	100	± 10%	60	85	165	56.0	4000	● ■						
ROV20-121K	120		75	100	200	64.0	3800	● ■						
ROV20-151K	150		95	125	250	88.0	3000	● ■						
ROV20-181K	180		115	150	300	104.0	2400	● ■						
ROV20-201K	200		130	170	340	114.0	1829	◆ ● ▲ ■						
ROV20-221K	220		140	180	360	124.0	1600	◆ ● ▲ ■						
ROV20-241K	240		150	200	395	134.0	1422	◆ ● ▲ ■						
ROV20-271K	270		175	225	455	158.0	1261	◆ ● ▲ ■						
ROV20-301K	300		195	250	505	168.0	1100	◆ ● ▲ ■						
ROV20-331K	330		210	275	550	184.0	1106	◆ ● ▲ ■						
ROV20-361K	360	230	300	595	208.0	987	◆ ● ▲ ■							
ROV20-391K	390	250	320	650	240.0	975	◆ ● ▲ ■							
ROV20-431K	430	275	350	710	264.0	858	◆ ● ▲ ■							
ROV20-471K	470	300	385	775	280.0	761	◆ ● ▲ ■							
ROV20-511K	510	320	418	842	296.0	792	◆ ● ▲ ■							
ROV20-561K	560	350	460	920	312.0	679	◆ ● ▲ ■							
ROV20-621K	620	385	505	1025	328.0	605	◆ ● ▲ ■							
ROV20-681K	680	420	560	1120	344.0	553	◆ ● ▲ ■							
ROV20-751K	750	460	615	1240	360.0	554	◆ ● ▲ ■							

# Metal Oxide Varistors

## Overvoltage Protection Device

**PRODUCT: ROV20, ROV20, ROV20E  
20mm Series**

308 Constitution Drive  
Menlo Park, CA 94025-1164  
Phone: 800-227-4856  
www.circuitprotection.com

*Raychem Circuit Protection Products*

DOCUMENT: SCD 25484  
PCN:  
REV LETTER: E  
REV DATE: JULY 19, 2007  
PAGE NO.: 4 of 13

ROV20-781K	780		485	64 0	1290				368.0	481	◆ ● ▲ ■
ROV20-821K	820		510	67 0	1355				376.0	519	◆ ● ▲ ■
ROV20-911K	910		550	74 5	1500				408.0	444	◆ ● ▲ ■
ROV20-102K	1000		625	82 5	1650				448.0	400	◆ ● ▲ ■
ROV20-112K	1100		680	89 5	1815				496.0	360	◆ ● ▲ ■
ROV20-182K	1800		1000	1465	2970				695.0	260	■*

\* Pending VDE Recognition

1) The clamping voltage for devices ROV20-220M to ROV20-680L is tested with 20A current.

**PULSE LIFETIME RATING CURVES**  
**STANDARD SERIES**

**V-I CHARACTERISTIC CURVES**  
**STANDARD SERIES**

**ROV20-220M – ROV20-680K**

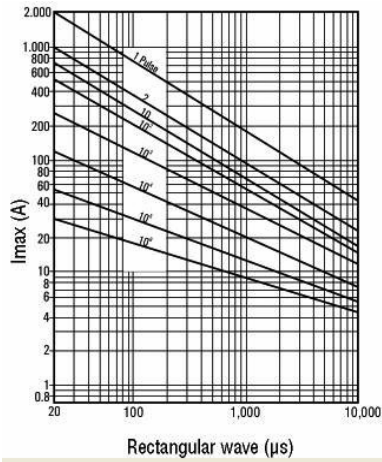

**ROV20-220M – ROV20-680K**

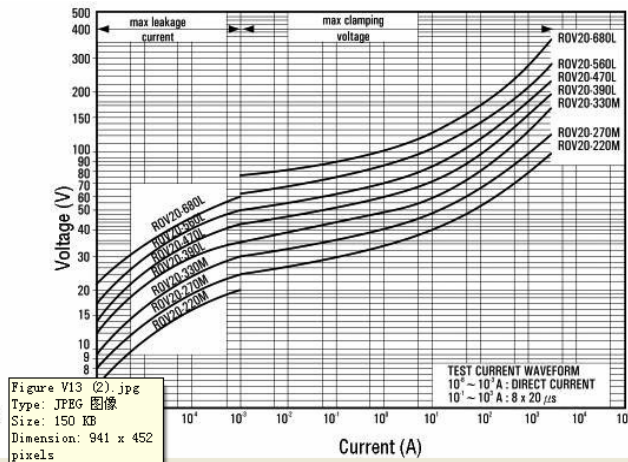
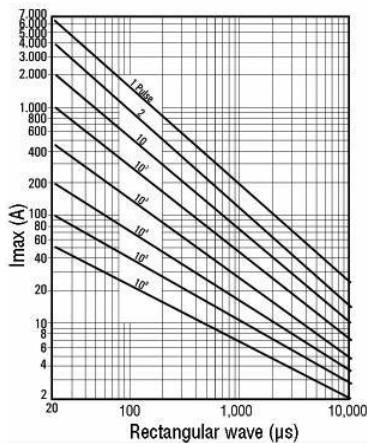

Figure V13 (2).jpg  
Type: JPEG 图像  
Size: 150 KB  
Dimension: 941 x 452 pixels

**ROV20-101K – ROV20-511K**



**ROV20-101K – ROV20-511K**

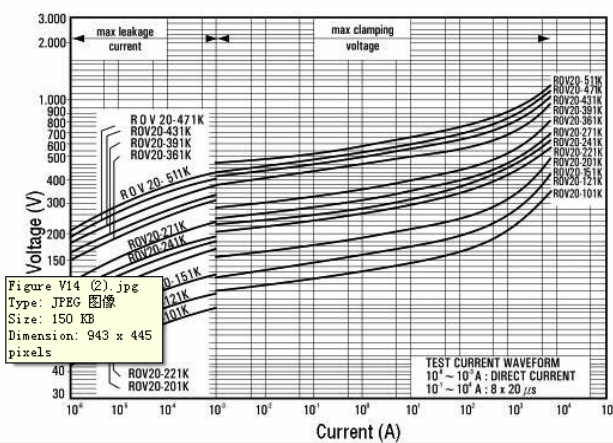
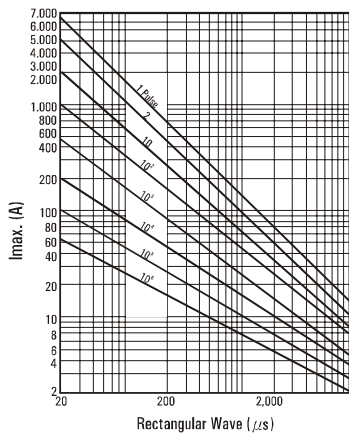
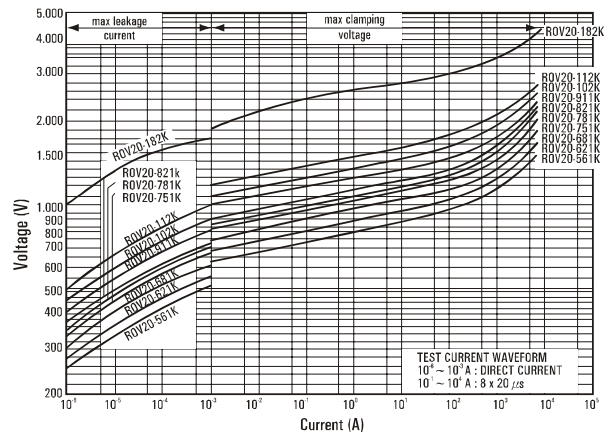

Figure V14 (2).jpg  
Type: JPEG 图像  
Size: 150 KB  
Dimension: 943 x 445 pixels

**ROV20-561K – ROV20-182K**



**ROV20-561K – ROV20-182K**



### DEVICE RATINGS AND CHARACTERISTICS

#### HIGH SURGE SERIES

Part Number	Varistor Voltage V@1.0mA		Maximum Allowable Voltage		Maximum Clamping Voltage V@100A	Maximum Surge Current (8x20us)		Rated Wattage	Energy (10x1000us)	Capacitance (Typical)	Certifications			
	(V <sub>DC</sub> )	Tolerance	V <sub>rms</sub> (V <sub>AC</sub> )	(V <sub>DC</sub> )	(V <sub>DC</sub> )	1 Time (A)	2 Times (A)	(W)	(J)	@1kHz (pF)				
ROV20H220 M	22	± 20%	14	18	43 <sup>1)</sup>	3000	2000	0.20	16.0	21200	● ■			
ROV20H270 M	27		17	22	53 <sup>1)</sup>				19.0	20000	● ■			
ROV20H330 M	33		20	26	65 <sup>1)</sup>				24.0	17200	● ■			
ROV20H390 L	39	± 15%	25	31	77 <sup>1)</sup>				10000	6500	1.00	28.0	15000	● ■
ROV20H470 L	47		30	38	93 <sup>1)</sup>							34.0	12100	● ■
ROV20H560 L	56		35	45	110 <sup>1)</sup>							41.0	11600	● ■
ROV20H680 L	68		40	56	135 <sup>1)</sup>							49.0	9600	● ■
ROV20H101 K	100	± 10%	60	85	165	72.0	4000	● ■						
ROV20H121 K	120		75	100	200	88.0	3800	● ■						
ROV20H151 K	150		95	125	250	106.0	3000	● ■						
ROV20H181 K	180		115	150	300	130.0	2400	● ■						
ROV20H201 K	200		130	170	340	140.0	1830	◆ ● ▲ ■						
ROV20H221 K	220		140	180	360	155.0	1600	◆ ● ▲ ■						
ROV20H241 K	240		150	200	395	168.0	1420	◆ ● ▲ ■						
ROV20H271 K	270		175	225	455	190.0	1260	◆ ● ▲ ■						
ROV20H301 K	300		195	250	505	210.0	1100	◆ ● ▲ ■						
ROV20H331 K	330		210	275	550	228.0	1110	◆ ● ▲ ■						
ROV20H361 K	360		230	300	595	255.0	990	◆ ● ▲ ■						
ROV20H391 K	390		250	320	650	275.0	980	◆ ● ▲ ■						
ROV20H431 K	430		275	350	710	303.0	860	◆ ● ▲ ■						
ROV20H471 K	470		300	385	775	350.0	760	◆ ● ▲ ■						
ROV20H511 K	510	320	418	842	382.0	790	◆ ● ▲ ■							
ROV20H561 K	560	350	460	920	410.0	680	◆ ● ▲ ■							



308 Constitution Drive  
Menlo Park, CA 94025-1164  
Phone: 800-227-4856  
www.circuitprotection.com

*Raychem Circuit Protection Products*

DOCUMENT: SCD 25484  
PCN:  
REV LETTER: E  
REV DATE: JULY 19, 2007  
PAGE NO.: 7 of 13

ROV20H621 K	620		385	505	1025				420.0	600	◆ ● ▲ ■
ROV20H681 K	680		420	560	1120				430.0	550	◆ ● ▲ ■
ROV20H751 K	750		460	615	1240				440.0	550	◆ ● ▲ ■
ROV20H781 K	780		485	640	1290				450.0	480	◆ ● ▲ ■
ROV20H821 K	820		510	670	1355				460.0	520	◆ ● ▲ ■
ROV20H911 K	910		550	745	1500				510.0	440	◆ ● ▲ ■
ROV20H102 K	1000		625	825	1650				566.0	400	◆ ● ▲ ■
ROV20H112 K	1100		680	895	1815				620.0	360	◆ ● ▲ ■

1) The clamping voltage for devices ROV20H220M to ROV20H680L is tested with 20A current.

### PULSE LIFETIME RATING CURVES HIGH SURGE SERIES

### V-I CHARACTERISTIC CURVES HIGH SURGE SERIES

ROV20H220M – ROV20H680K

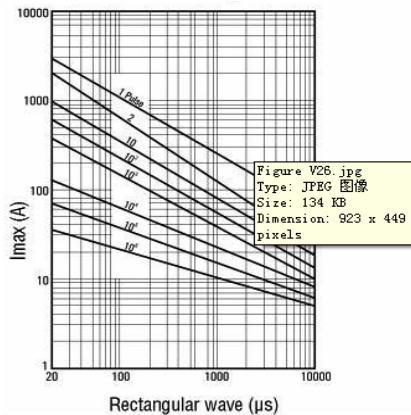

ROV20H220M – ROV20H680K

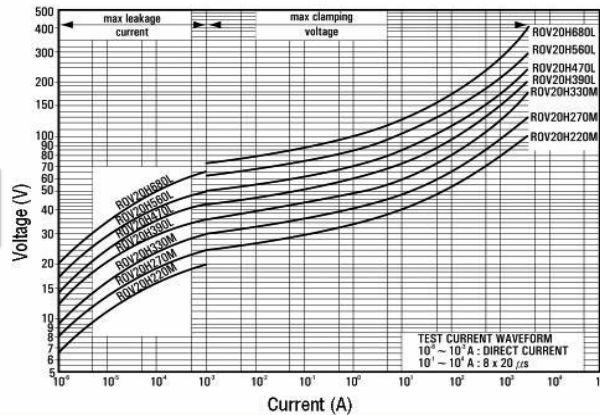

ROV20H101K

ROV20H511K

ROV20H101K – ROV20H511K

308 Constitution Drive  
Menlo Park, CA 94025-1164  
Phone: 800-227-4856  
www.circuitprotection.com

**Raychem Circuit Protection Products**

DOCUMENT: SCD 25484  
PCN:  
REV LETTER: E  
REV DATE: JULY 19, 2007  
PAGE NO.: 8 of 13

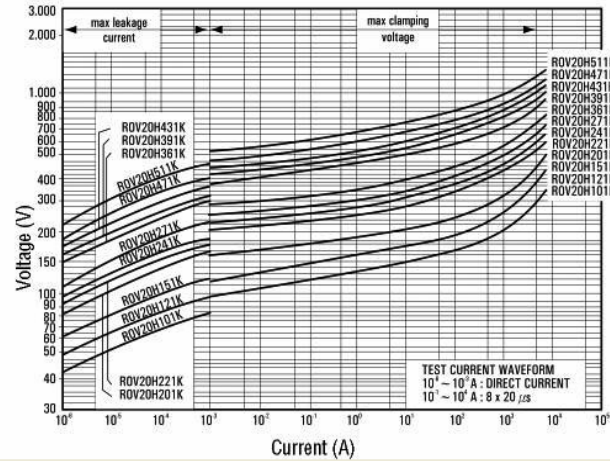
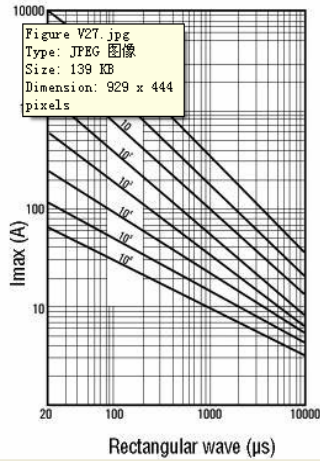

**ROV20H561K – ROV20H182K**

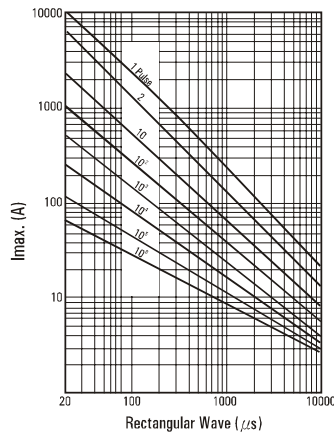

**ROV20H561K – ROV20H182K**

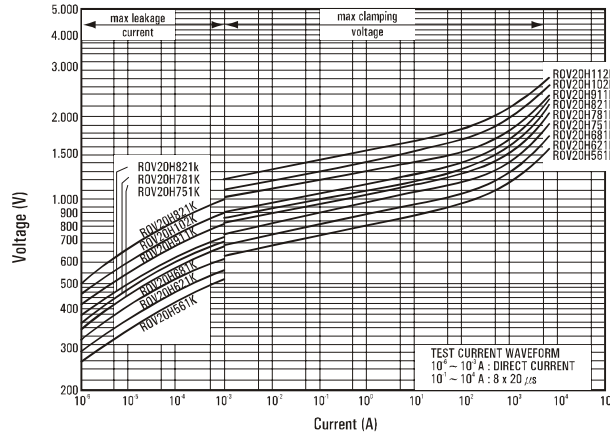

**DEVICE RATINGS AND CHARACTERISTICS**

**EXTRA HIGH SURGE SERIES**

Part Number	Varistor Voltage V@1.0mA		Maximum Allowable Voltage		Maximum Clamping Voltage V@100A	Maximum Surge Current (8x20us)		Rated Wattage (W)	Energy (10x1000us)	Capacitance (Typical) @1kHz (pF)	Certifications
	(V <sub>DC</sub> )	Tolerance	V <sub>rms</sub> (V <sub>AC</sub> )	(V <sub>DC</sub> )	(V <sub>DC</sub> )	1 Time (A)	2 Times (A)		(J)		
ROV20E201K	200	± 10%	130	170	340	12500	10000	1.00	168.0	1830	• ▲
ROV20E221K	220		140	180	360				186.0	1600	• ▲
ROV20E241K	240		150	200	395				202.0	1420	• ▲
ROV20E271K	270		175	225	455				227.0	-----	
ROV20E301K	300		195	250	505				252.0	-----	
ROV20E331K	330		210	275	550				277.0	-----	



ROV20E361K	360		230	300	595				302.0	-----
------------	-----	--	-----	-----	-----	--	--	--	-------	-------

**DIMENSIONS**

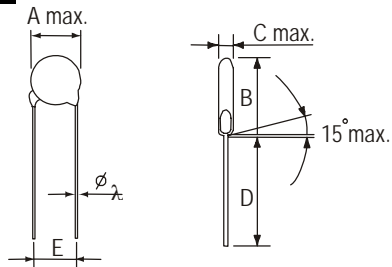

**KINKED LEAD TYPE**  
Dimension Table

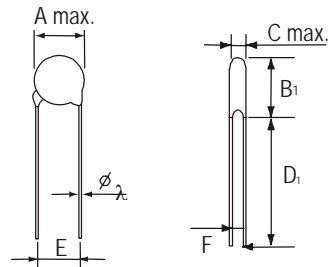

**STRAIGHT LEAD TYPE (-S)**  
Table of C max., F, and B<sub>1</sub> max.

# Metal Oxide Varistors

## Overvoltage Protection Device

308 Constitution Drive  
 Menlo Park, CA 94025-1164  
 Phone: 800-227-4856  
 www.circuitprotection.com

*Raychem Circuit Protection Products*

**PRODUCT: ROV20, ROV20, ROV20E  
 20mm Series**

DOCUMENT: SCD 25484  
 PCN:  
 REV LETTER: E  
 REV DATE: JULY 19, 2007  
 PAGE NO.: 10 of 13

A max.	23.0
$\lambda \pm 0.05$	1.0
E $\pm 1.0$	10.0
B max.	28.0
D <sub>1</sub> min.	25.0
D min.	24.0

Type No.	C max.	F $\pm 0.8$	B <sub>1</sub> max.
220M	5.3	1.0	26.5
270K	5.4	1.1	26.5
330K	5.4	1.2	26.5
390K	5.4	1.4	26.5
470K	5.6	1.4	26.5
560K	5.6	1.6	26.5
680K	6.1	1.9	26.5
101K	5.1	1.2	26.5
121K	5.3	1.3	26.5
151K	5.6	1.6	26.5
181K	5.2	1.4	26.5
201K	5.3	1.4	26.5
221K	5.4	1.5	26.5
241K	5.5	1.7	26.5
271K	5.7	1.9	26.5
301K	5.9	2.1	26.5
331K	6.0	2.1	26.5
361K	6.2	2.3	26.5
391K	6.4	2.4	26.5
431K	7.2	2.7	26.5
471K	7.5	2.9	27.0
511K	7.7	3.3	27.0
561K	8.0	3.6	27.0
621K	8.3	4.1	27.0
681K	8.7	4.4	27.0
751K	9.1	4.5	27.0
781K	9.3	4.8	27.0
821K	9.5	4.8	27.0
911K	10.1	5.7	27.0
102K	10.7	5.8	27.0
112K	11.2	6.3	27.0
182K	13.5	10.4	29.0

### PACKAGING

in mm

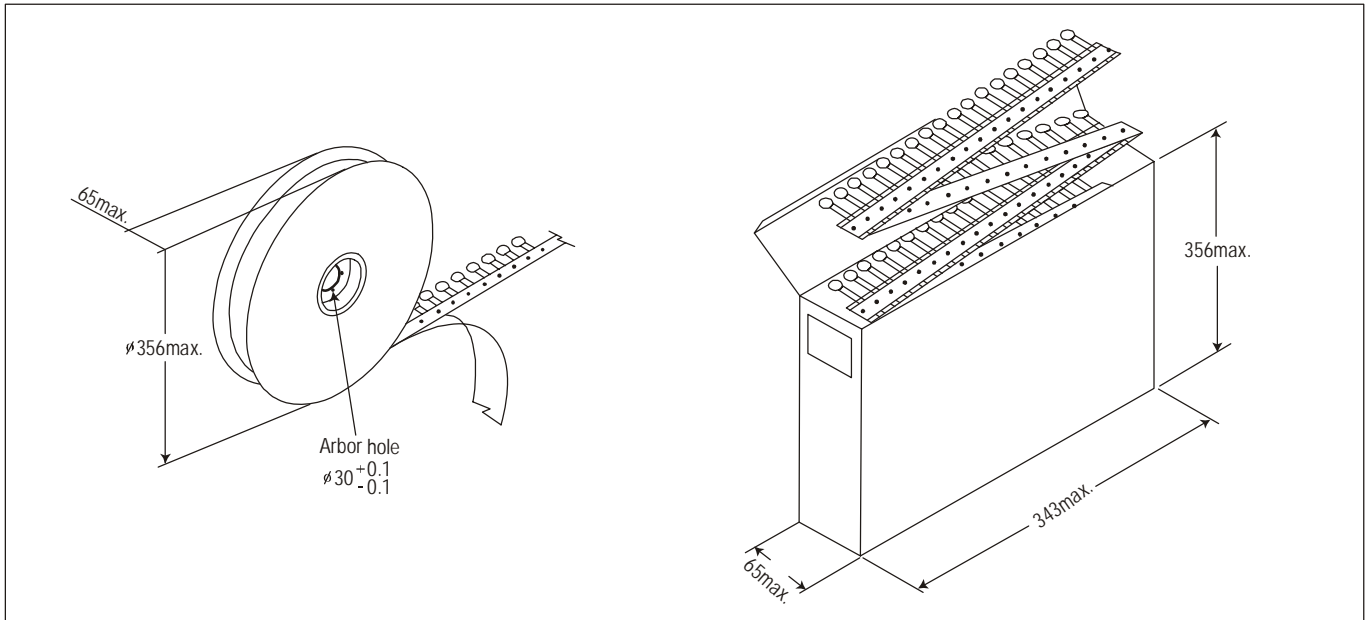

Packaging	Bulk (box)	Reel	Ammo
Box size (mm)	290 x 155 x 110	350 x 350 x 74	343 x 220 x 58
Carton size (mm)	310 x 328 x 250	370 x 370 x 468	363 x 460 x 250
One carton with	4 Boxes	6 Boxes (6 reels)	8 Boxes

Part Number	Bulk (box)	Reel	Ammo
ROV20-220M to ROV20-470K ROV20H220M to ROV20H470K	750	500	500
ROV20-560K to ROV20-680K, ROV20H560K to ROV20H680K	750	500	500
ROV20-101K to ROV20-331K, ROV20H101K to ROV20H331K	750	500	500
ROV20-361K to ROV20-391K, ROV20H361K to ROV20H391K	750	500	500
ROV20-431K to ROV20-471K, ROV20H431K to ROV20H471K	750	500	500
ROV20-511K to ROV20-681K, ROV20H511K to ROV20H681K	450	500	500
ROV20-751K to ROV20-182K, ROV20H751K to ROV20H112K	450	---	500

### TAPE AND REEL DIMENSIONS

1/2" Pitch

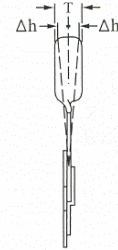
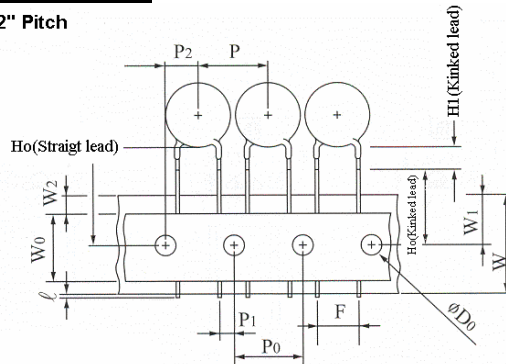

1.0" Pitch

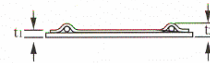
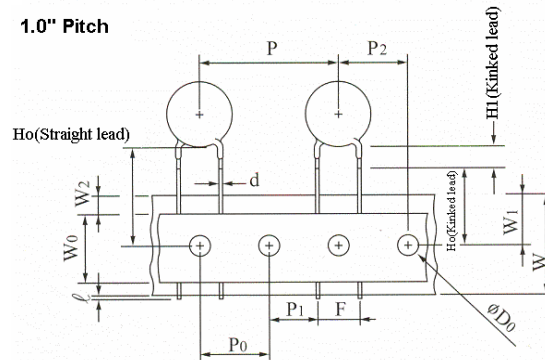

Symbols	Item	Value
l	Cut out length	1.1mm max.
H <sub>1</sub> (Kinked type)	Height of kink	3.5mm max.
H <sub>0</sub> (Kinked type)	Height to seating plane	16.0 ± 0.5mm
H <sub>0</sub> (Straight type)	Height of component from hole center	16.0-21.0mm
Δh	Front to back deviation	0.0 ± 2.0mm
W	Carrier tape width	18.0 <sup>+1.0</sup> <sub>-0.5</sub> mm
W <sub>0</sub>	Hold down tape width	12.0mm
W <sub>1</sub>	Sprocket hole position	9.0 <sup>+0.75</sup> <sub>-0.5</sub> mm
W <sub>2</sub>	Adhesive tape position	3.0mm max.
F	Component lead spacing	10.0 <sup>+0.8</sup> <sub>-0.2</sub> mm
P	Pitch of component	25.4 ± 1.0mm
P <sub>0</sub>	Sprocket hole pitch	12.7 ± 0.3mm
P <sub>1</sub>	Lead length from hole center to lead	7.7 ± 0.7mm, 8.95 ± 0.7mm
P <sub>2</sub>	Length from hole center to disk center	12.7 ± 1.3mm
D <sub>0</sub>	Sprocket hole diameter	4.0 ± 0.2mm
d	Lead wire diameter	0.8 ± 0.05mm, 1.0 ± 0.05mm
T	Disk thickness	See C. max table
t <sub>1</sub>	Total thickness tape	0.7 ± 0.05mm
t <sub>2</sub>	Total thickness	1.8mm max.



308 Constitution Drive  
Menlo Park, CA 94025-1164  
Phone: 800-227-4856  
www.circuitprotection.com

## Metal Oxide Varistors

Overvoltage Protection Device

*Raychem Circuit Protection Products*

**PRODUCT: ROV20, ROV20, ROV20E  
20mm Series**

DOCUMENT: SCD 25484  
PCN:  
REV LETTER: E  
REV DATE: JULY 19, 2007  
PAGE NO.: 13 of 13

Information furnished is believed to be accurate and reliable. However, users should independently evaluate the suitability of each product for their applications. Tyco Electronics Corporation assumes no responsibility for the use of its product or for any infringement of patents or other rights of third parties resulting from the use of its product. No license is granted by implication or otherwise under any patent or proprietary right of Tyco Electronics except the right to use such product for the purpose for which it is sold. Tyco Electronics reserves the right to change or update, without notice, any information contained in this publication; to change, without notice, the design, construction, processing, or specification of any product; and to discontinue or limit production or distribution of any product. This publication supersedes and replaces all information previously supplied. Without expressed or written consent by an officer of Tyco Electronics, Tyco Electronics does not authorize the use of any of its products as components in nuclear facility applications, aerospace, or in critical life support devices or systems. Tyco Electronics' only obligations are those in the Tyco Electronics Standard Terms and Conditions of Sale and in no case will Tyco Electronics be liable for any incidental, indirect, or consequential damages arising from the sale, resale, use, or misuse of its products.

© 2007 Tyco Electronics Corporation. All rights reserved.