

### GENERAL DESCRIPTION

The ROV10-XXX (Radial-leaded Metal Oxide Varistor) products are 10mm radial leaded varistor devices suitable for protection of overvoltage transients.

ROV devices can provide protection for a wide variety of power systems against overvoltage faults such as lightning, power contact and power induction. Suitable for a broad range of applications including, but not limited to security, power supplies, surge strips, etc., the ROV device helps to protect valuable equipment from potential power surge damage by clamping high energy, short duration impulses. The ROV devices have high current handling and energy absorption capability and fast response times to help protect against transient faults.

### FEATURES

- Radial leaded
- Broad Varistor voltage and  $V_{rms}$  range
  - Varistor voltage : 18V - 1800V
  - $V_{rms}$  voltage : 11V - 1000V
- Two surge capability series
  - Standard series, High surge series
- Various lead types
  - Straight, Kinked, Other
- Various packaging options
  - Bulk, Tape & Reel, Ammo Pack
- Helps designers meet the following standards
  - UL, CSA, VDE
- Fast response time
- High current and energy absorption capability

### APPLICATIONS

- Power supplies and power systems
- Line voltage
- Telecommunications systems
- Automotive systems
- Appliances

### TYPICAL APPLICATION SCHEMATIC



\*In some applications, a polymeric PTC device such as a Tyco Electronics PolySwitch device may be used instead of a fuse to provide a preferred solution.

### MATERIALS INFORMATION

RoHS Compliant

ELV Compliant

Directive 2002/95/EC  
Compliant

Directive 2000/53/EC  
Compliant

\*After May 1, 2005 all ROV devices will be produced as RoHS compliant devices.

## PART NUMBERING

**ROV 10 - 241 K -S -2**

**Manufacturer series**

**Disk Diameter**  
10mm

**Surge series**

- : Standard Series  
H : High Surge Series

**Varistor Voltage**

241 =  $24 \times 10^{+1} = 240V$

**Packaging**

: Bulk  
-2 : Tape & Reel  
-AP : Ammo Pack

**Lead Type**

: Kinked Lead  
-S : Straight Lead

**Tolerance**

K :  $\pm 10\%$   
L :  $\pm 15\%$   
M :  $\pm 20\%$

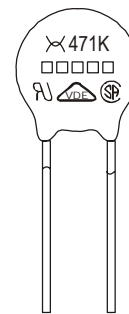
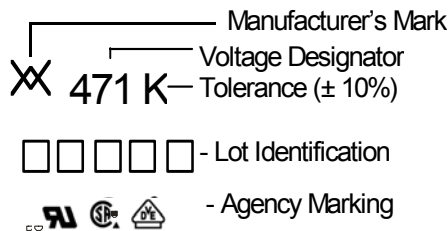

### **Lot Identification**

RoHS compliant devices: 4 characters

Non RoHS compliant devices: 5 characters with M at the end.

## GENERAL CHARACTERISTICS

|   |                         |
|---|-------------------------|
| Storage temperature:                          | -40°C ... +125°C        |
| Maximum operating temperature:                | -40°C ... + 85°C        |
| Maximum working surface temperature:          | +115°C                  |
| Temperature coefficient of voltage:           | 0 ... +0.05% / °C max.  |
| Insulation resistance of coating (@ 500 VDC): | Over 1000MΩ             |
| Maximum response time:                        | 25ns                    |
| Lead Material:                                | 22 AWG Sn Plated Copper |

## AGENCY RECOGNITION

Device Ratings and Characteristics Tables contain specific recognition information for each individual part. The table below details marking symbols for each agency recognition type.

|        |                         |     |     |
|--------|-------------------------|-----|-----|
| UL1414 | UL1449<br>(2nd Edition) | CSA | VDE |
| ◆      | ●                       | ▲   | ■   |

### DEVICE RATINGS AND CHARACTERISTICS

#### STANDARD SERIES

| Part Number | Varistor Voltage<br>V@1.0mA |           | Maximum Allowable Voltage              |                    | Maximum Clamping Voltage<br>V@25A | Maximum Surge Current<br>(8x20us) |                   | Rated Wattage | Energy<br>(10x1000us) | Capacitance<br>(Typical) | Certifications |
|-------------|-----------------------------|-----------|--|--------------------|-----------------------------------|-----------------------------------|-------------------|---------------|-----------------------|--------------------------|----------------|
|             | (V <sub>DC</sub> )          | Tolerance | V <sub>rms</sub><br>(V <sub>AC</sub> ) | (V <sub>DC</sub> ) | (V <sub>DC</sub> )                | 1<br>Time<br>(A)                  | 2<br>Times<br>(A) | (W)           | (J)                   | @1kHz<br>(pF)            |                |
| ROV10-180M  | 18                          | ± 20%     | 11                                     | 14                 | 36 <sup>1)</sup>                  | 500                               | 250               | 0.05          | 2.4                   | 6500                     | ● ■            |
| ROV10-220L  | 22                          | ± 15%     | 14                                     | 18                 | 43 <sup>1)</sup>                  |                                   |                   |               | 2.7                   | 5521                     | ● ■            |
| ROV10-270K  | 27                          | ± 10%     | 17                                     | 22                 | 53 <sup>1)</sup>                  |                                   |                   |               | 3.5                   | 4742                     | ● ■            |
| ROV10-330K  | 33                          |           | 20                                     | 26                 | 65 <sup>1)</sup>                  |                                   |                   |               | 4.4                   | 4247                     | ● ■            |
| ROV10-390K  | 39                          |           | 25                                     | 31                 | 77 <sup>1)</sup>                  |                                   |                   |               | 4.7                   | 3658                     | ● ■            |
| ROV10-470K  | 47                          |           | 30                                     | 38                 | 93 <sup>1)</sup>                  |                                   |                   |               | 6.0                   | 3137                     | ● ■            |
| ROV10-560K  | 56                          |           | 35                                     | 45                 | 110 <sup>1)</sup>                 |                                   |                   |               | 7.0                   | 2900                     | ● ■            |
| ROV10-680K  | 68                          |           | 40                                     | 56                 | 135 <sup>1)</sup>                 |                                   |                   |               | 8.5                   | 2230                     | ● ■            |
| ROV10-820K  | 82                          |           | 50                                     | 65                 | 135                               |                                   |                   |               | 11.0                  | 1261                     | ● ■            |
| ROV10-101K  | 100                         |           | 60                                     | 85                 | 165                               |                                   |                   |               | 14.0                  | 1021                     | ● ■            |
| ROV10-121K  | 120                         |           | 75                                     | 100                | 200                               | 16.0                              | 946               | ● ■           |                       |                          |                |
| ROV10-151K  | 150                         |           | 95                                     | 125                | 250                               | 22.0                              | 733               | ● ■           |                       |                          |                |
| ROV10-181K  | 180                         | 115       | 150                                    | 300                | 26.0                              | 483                               | ● ■               |               |                       |                          |                |
| ROV10-201K  | 200                         | 130       | 170                                    | 340                | 28.5                              | 400                               | ◆ ● ▲ ■           |               |                       |                          |                |
| ROV10-221K  | 220                         | 140       | 180                                    | 360                | 31.0                              | 393                               | ◆ ● ▲ ■           |               |                       |                          |                |
| ROV10-241K  | 240                         | 150       | 200                                    | 395                | 33.5                              | 325                               | ◆ ● ▲ ■           |               |                       |                          |                |
| ROV10-271K  | 270                         | 175       | 225                                    | 455                | 39.5                              | 334                               | ◆ ● ▲ ■           |               |                       |                          |                |
| ROV10-301K  | 300                         | 195       | 250                                    | 505                | 42.0                              | 278                               | ◆ ● ▲ ■           |               |                       |                          |                |
| ROV10-331K  | 330                         | 210       | 275                                    | 550                | 46.0                              | 275                               | ◆ ● ▲ ■           |               |                       |                          |                |
| ROV10-361K  | 360                         | 230       | 300                                    | 595                | 52.0                              | 231                               | ◆ ● ▲ ■           |               |                       |                          |                |
| ROV10-391K  | 390                         | 250       | 320                                    | 650                | 60.0                              | 247                               | ◆ ● ▲ ■           |               |                       |                          |                |
| ROV10-431K  | 430                         | 275       | 350                                    | 710                | 66.0                              | 216                               | ◆ ● ▲ ■           |               |                       |                          |                |
| ROV10-471K  | 470                         | 300       | 385                                    | 775                | 70.0                              | 210                               | ◆ ● ▲ ■           |               |                       |                          |                |
| ROV10-511K  | 510                         | 320       | 418                                    | 842                | 74.0                              | 187                               | ◆ ● ▲ ■           |               |                       |                          |                |
| ROV10-561K  | 560                         | 350       | 460                                    | 920                | 78.0                              | 186                               | ◆ ● ▲ ■           |               |                       |                          |                |
| ROV10-621K  | 620                         | 385       | 505                                    | 1025               | 82.0                              | 160                               | ◆ ● ▲ ■           |               |                       |                          |                |
| ROV10-681K  | 680                         | 420       | 560                                    | 1120               | 86.0                              | 156                               | ◆ ● ▲ ■           |               |                       |                          |                |
| ROV10-751K  | 750                         | 460       | 615                                    | 1240               | 90.0                              | 133                               | ◆ ● ▲ ■           |               |                       |                          |                |
| ROV10-781K  | 780                         | 485       | 640                                    | 1290               | 92.0                              | 117                               | ◆ ● ▲ ■           |               |                       |                          |                |
| ROV10-821K  | 820                         | 510       | 670                                    | 1355               | 94.0                              | 130                               | ◆ ● ▲ ■           |               |                       |                          |                |
| ROV10-911K  | 910                         | 550       | 745                                    | 1500               | 102.0                             | 111                               | ◆ ● ▲ ■           |               |                       |                          |                |
| ROV10-102K  | 1000                        | 625       | 825                                    | 1650               | 112.0                             | 96                                | ◆ ● ▲ ■           |               |                       |                          |                |
| ROV10-112K  | 1100                        | 680       | 895                                    | 1815               | 124.0                             | 88                                | ◆ ● ▲ ■           |               |                       |                          |                |
| ROV10-182K  | 1800                        | 1000      | 1465                                   | 2970               | 174.0                             | 65                                | ◆ ● ▲ ■*          |               |                       |                          |                |

\* Pending VDE Recognition

1) The clamping voltage for devices ROV10-180M to ROV10-680K is tested with 5A current.

**PULSE LIFETIME RATING CURVES**

**STANDARD SERIES**  
**ROV10-180M – ROV10-680K**

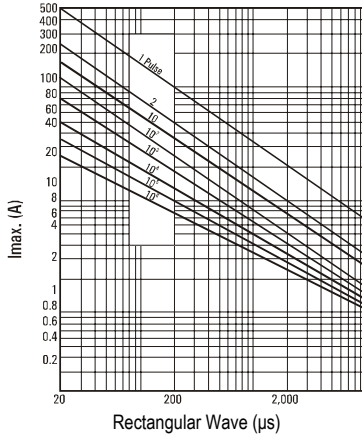

**V-I CHARACTERISTIC CURVES**

**STANDARD SERIES**  
**ROV10-180M – ROV10-680K**

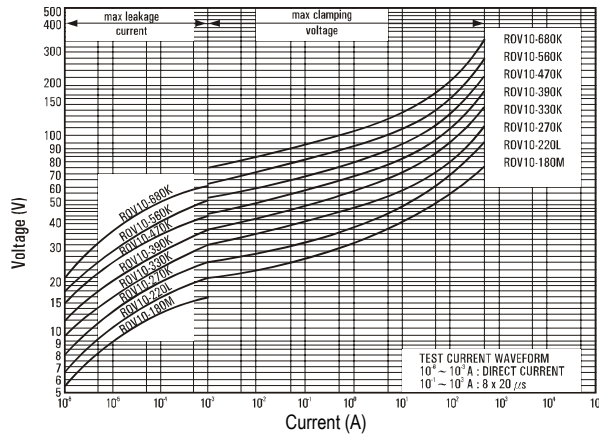

**ROV10-820K – ROV10-511K**

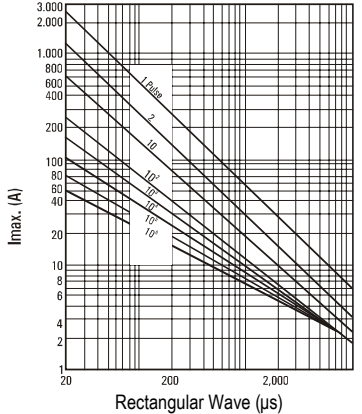

**ROV10-820K – ROV10-511K**



**ROV10-561K – ROV10-182K**

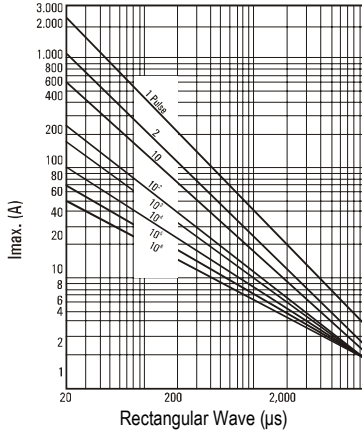

**ROV10-561K – ROV10-182K**

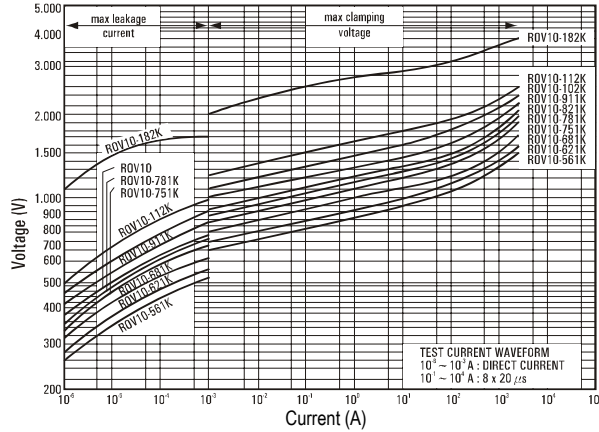

### DEVICE RATINGS AND CHARACTERISTICS

#### HIGH SURGE SERIES

| Part Number | Varistor Voltage<br>V@1.0mA |           | Maximum Allowable Voltage              |                    | Maximum Clamping Voltage<br>V@25A | Maximum Surge Current<br>(8x20us) |                   | Rated Wattage<br>(W) | Energy<br>(10x1000us)<br>(J) | Capacitance<br>(Typical)<br>@1kHz<br>(pF) | Certifications<br> |      |      |     |
|-------------|-----------------------------|-----------|--|--------------------|-----------------------------------|-----------------------------------|-------------------|----------------------|------------------------------|---|---|------|------|-----|
|             | (V <sub>DC</sub> )          | Tolerance | V <sub>rms</sub><br>(V <sub>AC</sub> ) | (V <sub>DC</sub> ) | (V <sub>DC</sub> )                | 1<br>Time<br>(A)                  | 2<br>Times<br>(A) |                      |                              |   |   |      |      |     |
| ROV10H180M  | 18                          | ± 20%     | 11                                     | 14                 | 36 <sup>1)</sup>                  | 1000                              | 500               | 0.05                 | 2.6                          | 6500                                      | ● ■   |      |      |     |
| ROV10H220L  | 22                          | ± 15%     | 14                                     | 18                 | 43 <sup>1)</sup>                  |                                   |                   |                      | 3.2                          | 5520                                      | ● ■   |      |      |     |
| ROV10H270K  | 27                          |           | 17                                     | 22                 | 53 <sup>1)</sup>                  |                                   |                   |                      | 3.9                          | 4740                                      | ● ■   |      |      |     |
| ROV10H330K  | 33                          | 20        | 26                                     | 65 <sup>1)</sup>   | 4.8                               |                                   |                   |                      | 4250                         | ● ■                                       |   |      |      |     |
| ROV10H390K  | 39                          | 25        | 31                                     | 77 <sup>1)</sup>   | 5.6                               |                                   |                   |                      | 3660                         | ● ■                                       |   |      |      |     |
| ROV10H470K  | 47                          | 30        | 38                                     | 93 <sup>1)</sup>   | 6.8                               |                                   |                   |                      | 3140                         | ● ■                                       |   |      |      |     |
| ROV10H560K  | 56                          | 35        | 45                                     | 110 <sup>1)</sup>  | 8.1                               |                                   |                   |                      | 2900                         | ● ■                                       |   |      |      |     |
| ROV10H680K  | 68                          | 40        | 56                                     | 135 <sup>1)</sup>  | 9.8                               |                                   |                   |                      | 2230                         | ● ■                                       |   |      |      |     |
| ROV10H820K  | 82                          | ± 10%     | 50                                     | 65                 | 135                               |                                   |                   |                      | 3500                         | 2500                                      | 0.40  | 14.0 | 1260 | ● ■ |
| ROV10H101K  | 100                         |           | 60                                     | 85                 | 165                               |                                   |                   |                      |                              |   |   | 18.0 | 1020 | ● ■ |
| ROV10H121K  | 120                         |           | 75                                     | 100                | 200                               | 22.0                              | 950               | ● ■                  |                              |   |   |      |      |     |
| ROV10H151K  | 150                         |           | 95                                     | 125                | 250                               | 25.0                              | 730               | ● ■                  |                              |   |   |      |      |     |
| ROV10H181K  | 180                         |           | 115                                    | 150                | 300                               | 32.0                              | 480               | ● ■                  |                              |   |   |      |      |     |
| ROV10H201K  | 200                         |           | 130                                    | 170                | 340                               | 35.0                              | 400               | ◆ ● ▲ ■              |                              |   |   |      |      |     |
| ROV10H221K  | 220                         |           | 140                                    | 180                | 360                               | 39.0                              | 390               | ◆ ● ▲ ■              |                              |   |   |      |      |     |
| ROV10H241K  | 240                         |           | 150                                    | 200                | 395                               | 42.0                              | 330               | ◆ ● ▲ ■              |                              |   |   |      |      |     |
| ROV10H271K  | 270                         |           | 175                                    | 225                | 455                               | 49.0                              | 330               | ◆ ● ▲ ■              |                              |   |   |      |      |     |
| ROV10H301K  | 300                         |           | 195                                    | 250                | 505                               | 52.0                              | 280               | ◆ ● ▲ ■              |                              |   |   |      |      |     |
| ROV10H331K  | 330                         | 210       | 275                                    | 550                | 58.0                              | 280                               | ◆ ● ▲ ■           |                      |                              |   |   |      |      |     |
| ROV10H361K  | 360                         | 230       | 300                                    | 595                | 65.0                              | 230                               | ◆ ● ▲ ■           |                      |                              |   |   |      |      |     |
| ROV10H391K  | 390                         | 250       | 320                                    | 650                | 70.0                              | 250                               | ◆ ● ▲ ■           |                      |                              |   |   |      |      |     |
| ROV10H431K  | 430                         | 275       | 350                                    | 710                | 80.0                              | 220                               | ◆ ● ▲ ■           |                      |                              |   |   |      |      |     |
| ROV10H471K  | 470                         | 300       | 385                                    | 775                | 85.0                              | 210                               | ◆ ● ▲ ■           |                      |                              |   |   |      |      |     |
| ROV10H511K  | 510                         | 320       | 418                                    | 842                | 92.0                              | 190                               | ◆ ● ▲ ■           |                      |                              |   |   |      |      |     |
| ROV10H561K  | 560                         | 350       | 460                                    | 920                | 102.0                             | 190                               | ◆ ● ▲ ■           |                      |                              |   |   |      |      |     |
| ROV10H621K  | 620                         | 385       | 505                                    | 1025               | 107.0                             | 160                               | ◆ ● ▲ ■           |                      |                              |   |   |      |      |     |
| ROV10H681K  | 680                         | 420       | 560                                    | 1120               | 112.0                             | 160                               | ◆ ● ▲ ■           |                      |                              |   |   |      |      |     |
| ROV10H751K  | 750                         | 460       | 615                                    | 1240               | 115.0                             | 130                               | ◆ ● ▲ ■           |                      |                              |   |   |      |      |     |
| ROV10H781K  | 780                         | 485       | 640                                    | 1290               | 116.0                             | 120                               | ◆ ● ▲ ■           |                      |                              |   |   |      |      |     |
| ROV10H821K  | 820                         | 510       | 670                                    | 1355               | 118.0                             | 130                               | ◆ ● ▲ ■           |                      |                              |   |   |      |      |     |
| ROV10H911K  | 910                         | 550       | 745                                    | 1500               | 127.0                             | 110                               | ◆ ● ▲ ■           |                      |                              |   |   |      |      |     |
| ROV10H102K  | 1000                        | 625       | 825                                    | 1650               | 140.0                             | 95                                | ◆ ● ▲ ■           |                      |                              |   |   |      |      |     |
| ROV10H112K  | 1100                        | 680       | 895                                    | 1815               | 155.0                             | 90                                | ◆ ● ▲ ■           |                      |                              |   |   |      |      |     |

1) The clamping voltage for devices ROV10H180M to ROV10H680K is tested with 5A current.

**PULSE LIFETIME RATING CURVES**

**HIGH SURGE SERIES**

**ROV10H180M – ROV10H680K**

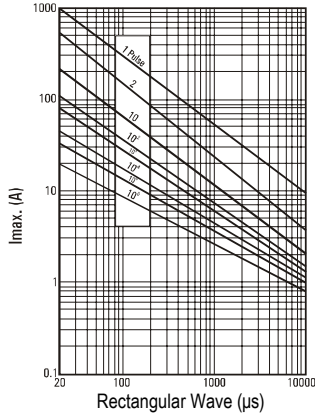

**V-I CHARACTERISTIC CURVES**

**HIGH SURGE SERIES**

**ROV10H180M – ROV10H680K**

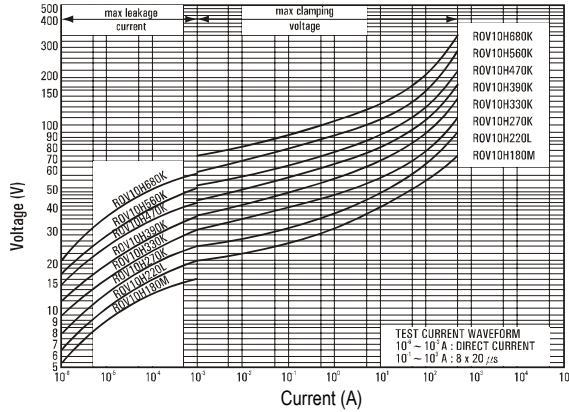

**ROV10H820K – ROV10H511K**

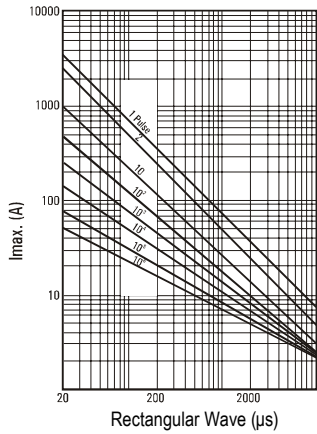

**ROV10H820K – ROV10H511K**

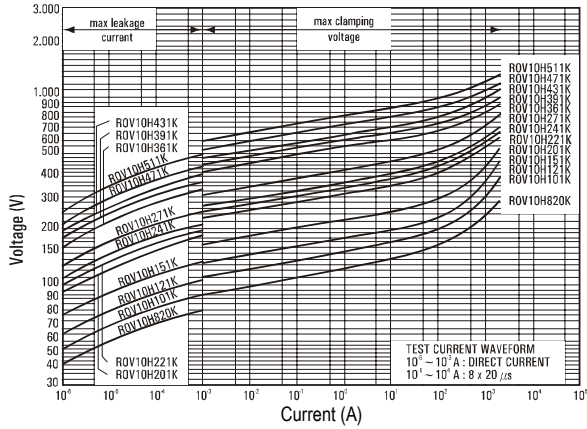

**ROV10H561K – ROV10H182K**

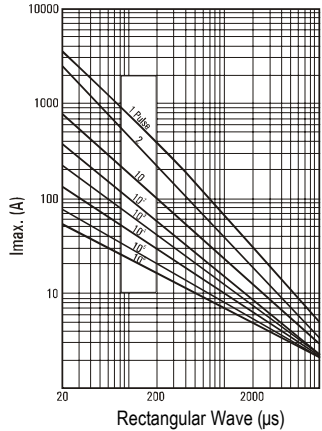

**ROV10H561K – ROV10H182K**

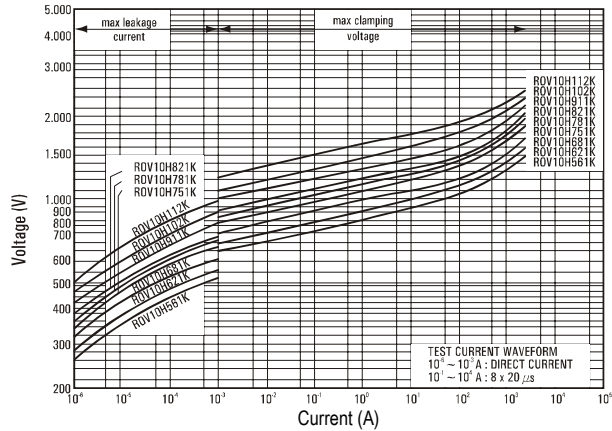

## DIMENSIONS

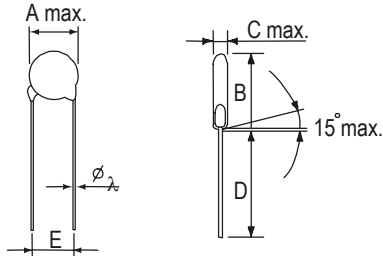

**KINKED LEAD TYPE**  
Dimension Table

|                    |      |
|--------------------|------|
| A max.             | 12.5 |
| $\lambda \pm 0.05$ | 0.8  |
| $E \pm 1.0$        | 7.5  |
| B max.             | 18.0 |
| $D_1$ min.         | 25.0 |
| D min.             | 24.0 |



**STRAIGHT LEAD TYPE (-S)**  
Table of C max., F, and  $B_1$  max.

| Type No. | C max. | $F \pm 0.8$ | $B_1$ max. |
|----------|--------|-------------|------------|
| 180M     | 4.9    | 0.8         | 15.5       |
| 220L     | 4.9    | 0.9         | 15.5       |
| 270K     | 5.1    | 0.9         | 15.5       |
| 330K     | 5.1    | 1.0         | 15.5       |
| 390K     | 5.1    | 1.2         | 15.5       |
| 470K     | 5.5    | 1.2         | 15.5       |
| 560K     | 5.5    | 1.4         | 15.5       |
| 680K     | 6.0    | 1.7         | 15.5       |
| 820K     | 4.3    | 0.8         | 15.5       |
| 101K     | 4.4    | 0.8         | 15.5       |
| 121K     | 4.5    | 0.9         | 15.5       |
| 151K     | 4.9    | 1.2         | 15.5       |
| 181K     | 4.5    | 1.0         | 15.5       |
| 201K     | 4.6    | 1.0         | 15.5       |
| 221K     | 4.7    | 1.1         | 15.5       |
| 241K     | 4.8    | 1.3         | 15.5       |
| 271K     | 5.0    | 1.4         | 15.5       |
| 301K     | 5.2    | 1.6         | 15.5       |
| 331K     | 5.3    | 1.6         | 15.5       |
| 361K     | 5.5    | 1.9         | 15.5       |
| 391K     | 5.7    | 2.2         | 16.0       |
| 431K     | 6.5    | 2.5         | 16.0       |
| 471K     | 6.8    | 2.6         | 16.0       |
| 511K     | 7.0    | 3.1         | 16.5       |
| 561K     | 7.3    | 3.4         | 16.5       |
| 621K     | 7.6    | 4.0         | 16.5       |
| 681K     | 8.0    | 4.4         | 16.5       |
| 751K     | 8.4    | 4.4         | 16.5       |
| 781K     | 8.6    | 4.6         | 16.5       |
| 821K     | 8.8    | 4.6         | 16.5       |
| 911K     | 9.4    | 5.4         | 16.5       |
| 102K     | 9.9    | 5.4         | 16.5       |
| 112K     | 10.5   | 5.7         | 16.5       |
| 182K     | 12.6   | 9.8         | 18.5       |



## PACKAGING

in mm

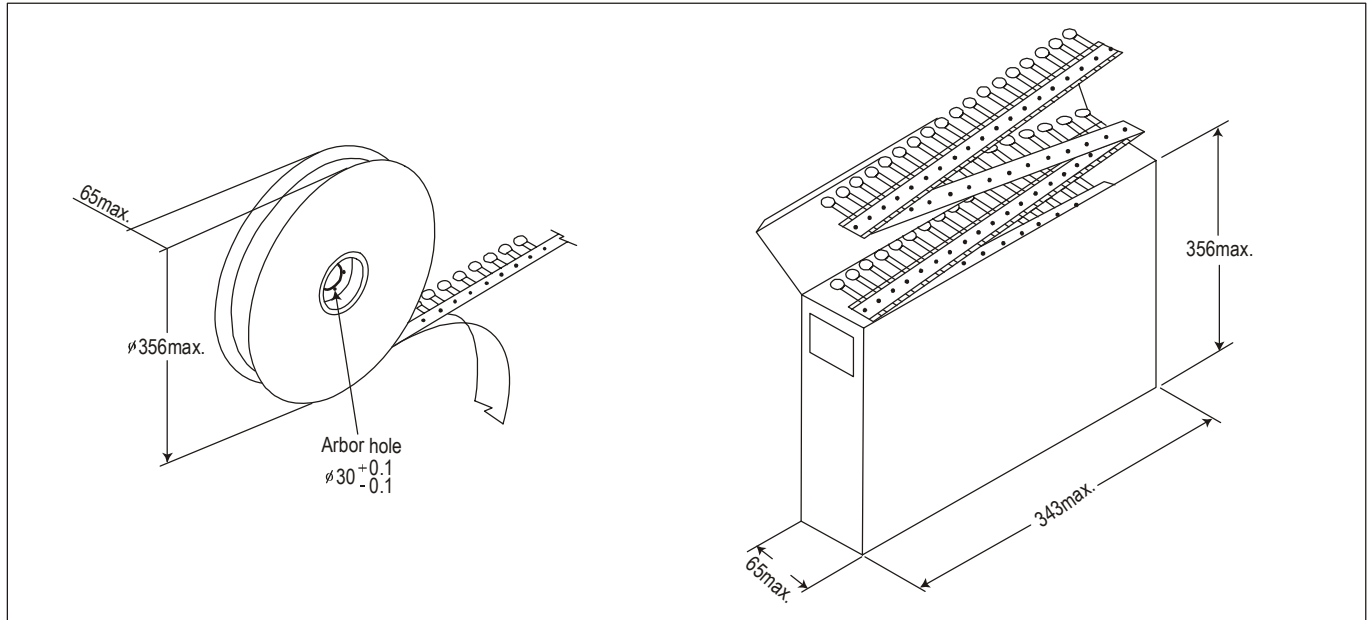

| Packaging        | Bulk (box)      | Reel               | Ammo            |
|------------------|-----------------|--------------------|-----------------|
| Box size (mm)    | 290 x 155 x 110 | 350 x 350 x 108    | 343 x 260 x 52  |
| Carton size (mm) | 310 x 328 x 250 | 371 x 371 x 590    | 363 x 540 x 250 |
| One carton with  | 4 Boxes         | 5 Boxes (10 reels) | 8 Boxes         |

| Part Number   | Bulk (box) | Reel | Ammo  |       |
|---|------------|------|-------|-------|
|   |            |      | F=7.5 | F=5.0 |
| ROV10-180M to ROV10-470K,<br>ROV10H180M to ROV10H470K   | 2500       | 1000 | 500   | 1000  |
| ROV10-560K to ROV10-680K,<br>ROV10H 560K to ROV10H 680K | 2500       | 1000 | 500   | 1000  |
| ROV10-820K to ROV10-331K,<br>ROV10H820K to ROV10H331K   | 2500       | 1000 | 500   | 1000  |
| ROV10-361K to ROV10-391K,<br>ROV10H361K to ROV10H391K   | 2500       | 1000 | 500   | 1000  |
| ROV10-431K to ROV10-471K,<br>ROV10H431K to ROV10H471K   | 2500       | 750  | 500   | 750   |
| ROV10-511K to ROV10-751K,<br>ROV10H511K to ROV10H751K   | 1500       | 500  | 500   | 500   |
| ROV10-751K to ROV10-182K,<br>ROV10H751K to ROV10H112K   | 1500       | 500  | 500   | 500   |



### TAPE AND REEL DIMENSIONS

1/2" Pitch

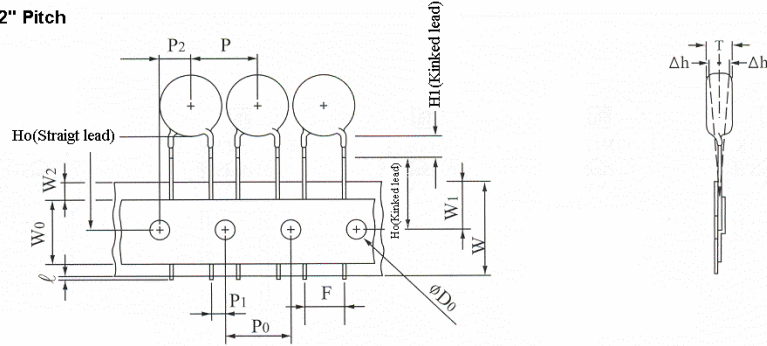

1.0" Pitch

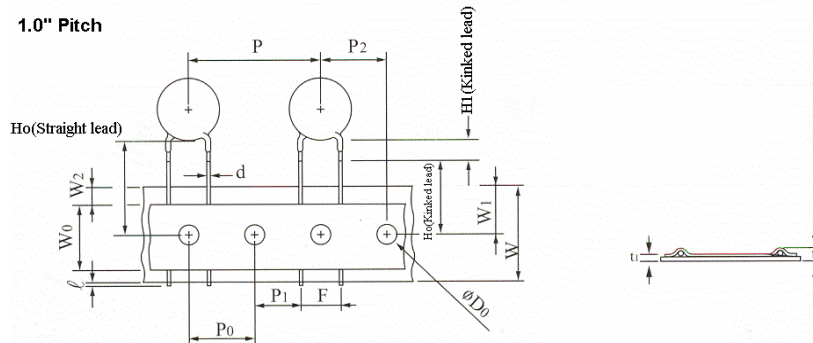

| Symbols               | Item                                   | Value   |
|-----------------------|--|---|
| $\lambda$             | Cut out length                         | 1.1mm max.  |
| $H_1$ (Kinked lead)   | Height of kink                         | 5.0mm max.  |
| $H_o$ (Kinked lead)   | Height to seating plane                | 16.0 $\pm$ 0.5mm                                  |
| $H_o$ (Straight lead) | Height of component from hole center   | 16.0-21.0mm                                       |
| $\Delta h$            | Front to back deviation                | 0.0 $\pm$ 2.0mm                                   |
| $W$                   | Carrier tape width                     | 18.0 $^{+1.0}_{-0.5}$ mm                          |
| $W_0$                 | Hold down tape width                   | 10.0mm, 12.0mm                                    |
| $W_1$                 | Sprocket hole position                 | 9.0 $^{+0.75}_{-0.5}$ mm                          |
| $W_2$                 | Adhesive tape position                 | 3.0mm max.  |
| $F$                   | Component lead spacing                 | 7.5 $^{+0.8}_{-0.2}$ mm , 5.0 $^{+0.8}_{-0.2}$ mm |
| $P$                   | Pitch of component                     | 12.7 $\pm$ 1.0mm, 25.4 $\pm$ 1.0mm                |
| $P_0$                 | Sprocket hole pitch                    | 12.7 $\pm$ 0.3mm                                  |
| $P_1$                 | Lead length from hole center to lead   | 3.85 $\pm$ 0.7mm, 8.95 $\pm$ 0.7mm                |
| $P_2$                 | Length from hole center to disk center | 6.35 $\pm$ 1.3mm, 12.7 $\pm$ 1.3mm                |
| $D_0$                 | Sprocket hole diameter                 | 4.0 $\pm$ 0.2mm                                   |
| $d$                   | Lead wire diameter                     | 0.6 $\pm$ 0.05mm, 0.8 $\pm$ 0.05mm                |
| $T$                   | Disk thickness                         | See C. max table                                  |
| $t_1$                 | Total thickness tape                   | 0.7 $\pm$ 0.05mm                                  |
| $t_2$                 | Total thickness                        | 1.6mm max. , 1.8mm max                            |



308 Constitution Drive  
Menlo Park, CA 94025-1164  
Phone: 800-227-4856  
www.circuitprotection.com

## Metal Oxide Varistors

Overvoltage Protection Device

*Raychem Circuit Protection Products*

**PRODUCT: ROV10, ROV10H**  
**10mm Series**

DOCUMENT: SCD 25482  
PCN:  
REV LETTER: D  
REV DATE: JULY 19, 2007  
PAGE NO.: 10 of 10

Information furnished is believed to be accurate and reliable. However, users should independently evaluate the suitability of each product for their applications. Tyco Electronics Corporation assumes no responsibility for the use of its product or for any infringement of patents or other rights of third parties resulting from the use of its product. No license is granted by implication or otherwise under any patent or proprietary right of Tyco Electronics except the right to use such product for the purpose for which it is sold. Tyco Electronics reserves the right to change or update, without notice, any information contained in this publication; to change, without notice, the design, construction, processing, or specification of any product; and to discontinue or limit production or distribution of any product. This publication supersedes and replaces all information previously supplied. Without expressed or written consent by an officer of Tyco Electronics, Tyco Electronics does not authorize the use of any of its products as components in nuclear facility applications, aerospace, or in critical life support devices or systems. Tyco Electronics' only obligations are those in the Tyco Electronics Standard Terms and Conditions of Sale and in no case will Tyco Electronics be liable for any incidental, indirect, or consequential damages arising from the sale, resale, use, or misuse of its products.

© 2007 Tyco Electronics Corporation. All rights reserved.