

GENERAL DESCRIPTION

The ROV05-XXX (Radial-leaded Metal Oxide Varistor) products are 5mm radial leaded varistor devices suitable for protection of overvoltage transients.

ROV devices can provide protection for a wide variety of power systems against overvoltage faults such as lightning, power contact and power induction. Suitable for a broad range of applications including, but not limited to security, power supplies, surge strips, etc., the ROV device helps to protect valuable equipment from potential power surge damage by clamping high energy, short duration impulses. The ROV devices have high current handling and energy absorption capability and fast response times to help protect against transient faults.

FEATURES

- Radial leaded
- Broad Varistor voltage and V_{rms} range
 - Varistor voltage : 18V - 750V
 - V_{rms} voltage : 11V - 460V
- Two surge capability series
 - Standard series, High surge series
- Various lead types
 - Straight, Kinked, Other
- Various packaging options
 - Bulk, Tape & Reel, Ammo Pack
- Helps designers meet the following standards
 - UL, CSA, VDE
- Fast response time
- High current and energy absorption capability

APPLICATIONS

- Power supplies and power systems
- Line voltage
- Telecommunications systems
- Automotive systems
- Appliances

TYPICAL APPLICATION SCHEMATIC

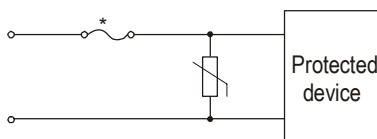

*In some applications, a polymeric PTC device such as a Tyco Electronics PolySwitch device may be used instead of a fuse to provide a preferred solution.

MATERIALS INFORMATION

RoHS Compliant

ELV Compliant

Directive 2002/95/EC
Compliant

Directive 2000/53/EC
Compliant

*After May 1, 2005 all ROV devices will be produced as RoHS compliant devices.

PART NUMBERING

ROV 05 - 241 K -S -2

Manufacturer Series

Disk Diameter
5mm

Surge Series

- : Standard Series
H : High Surge Series

Varistor Voltage

241 = $24 \times 10^1 = 240V$

Packaging

: Bulk
-2 : Tape & Reel
-AP : Ammo Pack

Lead Type

: Kinked Lead
-S : Straight Lead

Tolerance

K : $\pm 10\%$
L : $\pm 15\%$
M : $\pm 20\%$

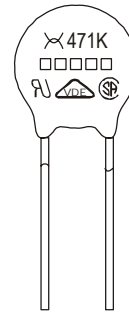
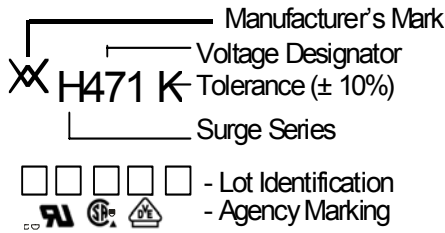

Lot Identification

RoHS compliant devices: 4 characters
Non RoHS compliant devices: 5 characters with M at the end.

GENERAL CHARACTERISTICS

Storage temperature: $-40^{\circ}C \dots +125^{\circ}C$
 Maximum operating temperature: $-40^{\circ}C \dots +85^{\circ}C$
 Maximum working surface temperature: $+115^{\circ}C$
 Temperature coefficient of voltage: $0 \dots +0.05\% / ^{\circ}C \text{ max.}$
 Insulation resistance of coating (@ 500 VDC): Over 1000M Ω
 Maximum response time: 25ns
 Lead Material: 22 AWG Sn Plated Copper

AGENCY RECOGNITION

Device Ratings and Characteristics Tables contain specific recognition information for each individual part. The table below details marking symbols for each agency recognition type.

| | | | |
|--------|-------------------------|-----|-----|
| UL1414 | UL1449 (2nd Edition) | CSA | VDE |
| ◆ | ● | ▲ | ■ |

DEVICE RATINGS AND CHARACTERISTICS

STANDARD SERIES

| Part Number | Varistor Voltage V@0.1mA | | Maximum Allowable Voltage | | Maximum Clamping Voltage V@5A | Maximum Surge Current (8x20us) | | Rated Wattage (W) | Energy (10x1000us) (J) | Capacitance (Typical) @1kHz (pF) | Certifications  | | | |
|-------------|-----------------------------|-----------|--|--------------------|----------------------------------|-----------------------------------|-------------------|----------------------|------------------------------|---|---|-----|-----|-----|
| | (V _{DC}) | Tolerance | V _{rms} (V _{AC}) | (V _{DC}) | (V _{DC}) | 1 Time (A) | 2 Times (A) | | | | | | | |
| ROV05-180M | 18 | ± 20% | 11 | 14 | 40 ¹⁾ | 100 | 50 | 0.01 | 0.6 | 1121 | ● ■* | | | |
| ROV05-220L | 22 | ± 15% | 14 | 18 | 48 ¹⁾ | | | | 0.7 | 1233 | ● ■* | | | |
| ROV05-270K | 27 | ± 10% | 17 | 22 | 60 ¹⁾ | | | | 0.9 | 1073 | ● ■* | | | |
| ROV05-330K | 33 | | 20 | 26 | 73 ¹⁾ | | | | 1.1 | 834 | ● ■* | | | |
| ROV05-390K | 39 | | 25 | 31 | 86 ¹⁾ | | | | 1.2 | 877 | ● ■* | | | |
| ROV05-470K | 47 | | 30 | 38 | 104 ¹⁾ | | | | 1.5 | 715 | ● ■* | | | |
| ROV05-560K | 56 | | 35 | 45 | 123 ¹⁾ | | | | 1.8 | 643 | ● ■* | | | |
| ROV05-680K | 68 | | 40 | 56 | 150 ¹⁾ | | | | 2.1 | 501 | ● ■* | | | |
| ROV05-820K | 82 | | 50 | 65 | 145 | | | | 400 | 200 | 0.1 | 2.8 | 269 | ● ■ |
| ROV05-101K | 100 | | 60 | 85 | 175 | | | | | | | 3.5 | 263 | ● ■ |
| ROV05-121K | 120 | | 75 | 100 | 210 | 4.0 | 180 | ● ■ | | | | | | |
| ROV05-151K | 150 | | 95 | 125 | 260 | 5.5 | 180 | ● ■ | | | | | | |
| ROV05-181K | 180 | 115 | 150 | 320 | 6.5 | 95 | ● ■ | | | | | | | |
| ROV05-201K | 200 | 130 | 170 | 355 | 7.1 | 85 | ◆ ● ▲ ■ | | | | | | | |
| ROV05-221K | 220 | 140 | 180 | 380 | 7.8 | 80 | ◆ ● ▲ ■ | | | | | | | |
| ROV05-241K | 240 | 150 | 200 | 415 | 8.4 | 74 | ◆ ● ▲ ■ | | | | | | | |
| ROV05-271K | 270 | 175 | 225 | 475 | 9.9 | 69 | ◆ ● ▲ ■ | | | | | | | |
| ROV05-301K | 300 | 195 | 250 | 525 | 10.5 | 65 | ◆ ● ▲ ■ | | | | | | | |
| ROV05-331K | 330 | 210 | 275 | 575 | 11.5 | 60 | ◆ ● ▲ ■ | | | | | | | |
| ROV05-361K | 360 | 230 | 300 | 620 | 13.0 | 69 | ◆ ● ▲ ■ | | | | | | | |
| ROV05-391K | 390 | 250 | 320 | 675 | 15.0 | 56 | ◆ ● ▲ ■ | | | | | | | |
| ROV05-431K | 430 | 275 | 350 | 745 | 16.5 | 47 | ◆ ● ▲ ■ | | | | | | | |
| ROV05-471K | 470 | 300 | 385 | 810 | 17.5 | 50 | ◆ ● ▲ ■ | | | | | | | |
| ROV05-511K | 510 | 320 | 418 | 880 | 18.5 | 50 | ◆ ● ▲ ■* | | | | | | | |
| ROV05-561K | 560 | 350 | 460 | 940 | 19.5 | 50 | ◆ ● ▲ ■* | | | | | | | |
| ROV05-621K | 620 | 385 | 505 | 1050 | 20.5 | 50 | ◆ ● ▲ ■* | | | | | | | |
| ROV05-681K | 680 | 420 | 560 | 1150 | 21.5 | 43 | ◆ ● ▲ ■* | | | | | | | |
| ROV05-751K | 750 | 460 | 615 | 1290 | 22.5 | ----- | ◆ ● ▲ ■* | | | | | | | |

* Pending VDE recognition

1) The clamping voltage for devices ROV05-180M to ROV05-680K is tested with 1A current.

PULSE LIFETIME RATING CURVES

V-I CHARACTERISTIC CURVES

STANDARD SERIES

STANDARD SERIES

ROV05-180M – ROV05-680K

ROV05-180M – ROV05-680K

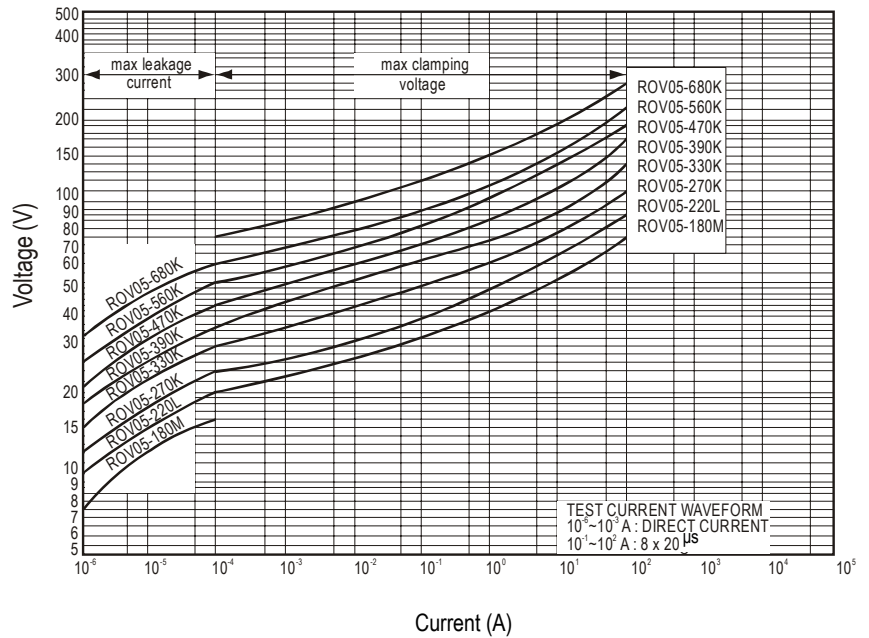
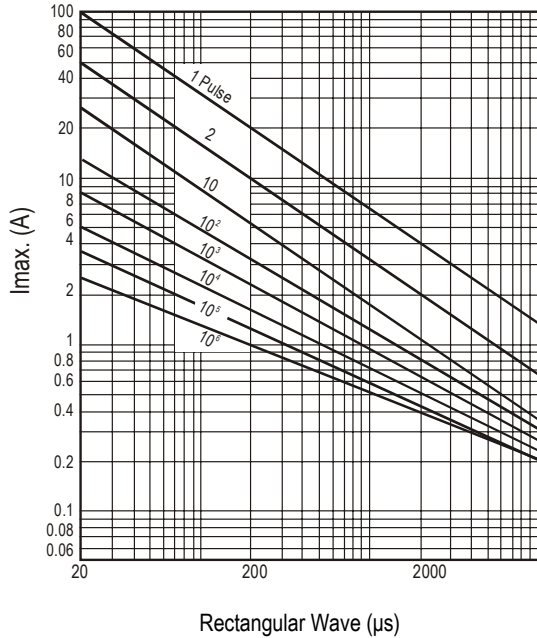

ROV05-820K – ROV05-471K

ROV05-820K – ROV05-471K

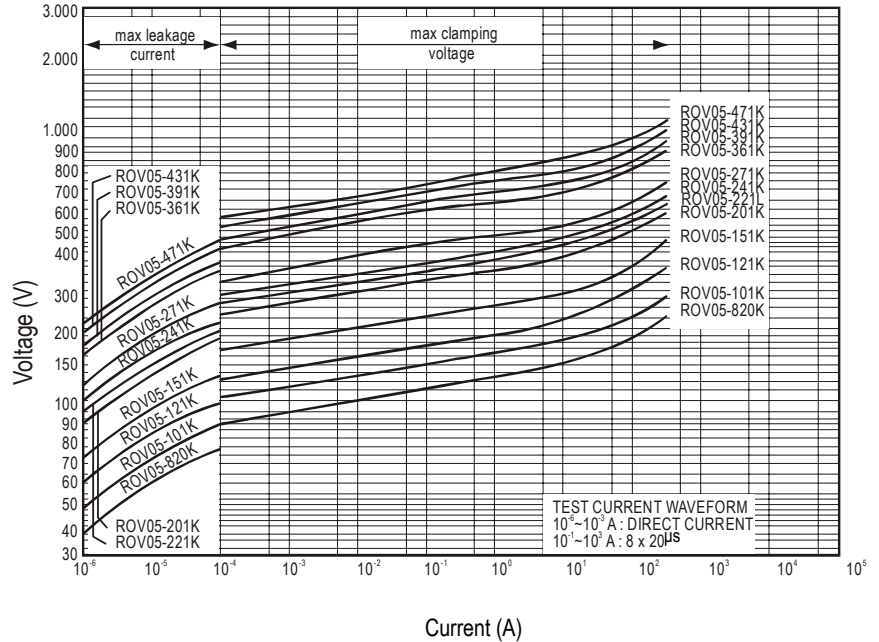
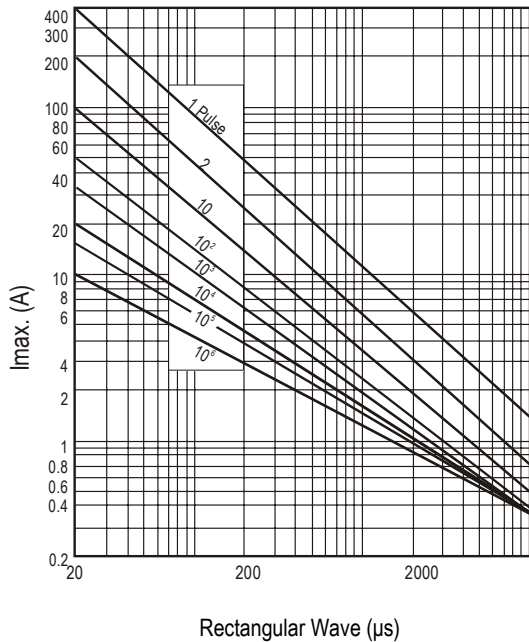

DEVICE RATINGS AND CHARACTERISTICS

HIGH SURGE SERIES

| Part Number | Varistor Voltage V@0.1mA | | Maximum Allowable Voltage | | Maximum Clamping Voltage V@5A | Maximum Surge Current (8x20us) | | Rated Wattage (W) | Energy (10x1000us) (J) | Capacitance (Typical) @1kHz (pF) | Certifications  | | | |
|-------------|-----------------------------|-----------|--|--------------------|----------------------------------|-----------------------------------|-------------------|----------------------|------------------------------|---|---|-----|-----|------|
| | (V _{DC}) | Tolerance | V _{rms} (V _{AC}) | (V _{DC}) | (V _{DC}) | 1 Time (A) | 2 Times (A) | | | | | | | |
| ROV05H180M | 18 | ± 20% | 11 | 14 | 40 ¹⁾ | 250 | 125 | 0.01 | 0.7 | 1120 | ● ■* | | | |
| ROV05H220L | 22 | ± 15% | 14 | 18 | 48 ¹⁾ | | | | 0.8 | 1230 | ● ■* | | | |
| ROV05H270K | 27 | ± 10% | 17 | 22 | 60 ¹⁾ | | | | 1.1 | 1070 | ● ■* | | | |
| ROV05H330K | 33 | | 20 | 26 | 73 ¹⁾ | | | | 1.3 | 830 | ● ■* | | | |
| ROV05H390K | 39 | | 25 | 31 | 86 ¹⁾ | | | | 1.5 | 880 | ● ■* | | | |
| ROV05H470K | 47 | | 30 | 38 | 104 ¹⁾ | | | | 1.8 | 720 | ● ■* | | | |
| ROV05H560K | 56 | | 35 | 45 | 123 ¹⁾ | | | | 2.2 | 640 | ● ■* | | | |
| ROV05H680K | 68 | | 40 | 56 | 150 ¹⁾ | | | | 2.6 | 500 | ● ■* | | | |
| ROV05H820K | 82 | | 50 | 65 | 145 | | | | 800 | 600 | 0.10 | 3.5 | 270 | ● ■* |
| ROV05H101K | 100 | | 60 | 85 | 175 | | | | | | | 4.5 | 260 | ● ■* |
| ROV05H121K | 120 | | 75 | 100 | 210 | 5.5 | 180 | ● ■* | | | | | | |
| ROV05H151K | 150 | | 95 | 125 | 260 | 6.5 | 180 | ● ■* | | | | | | |
| ROV05H181K | 180 | 115 | 150 | 320 | 8.0 | 95 | ● ■* | | | | | | | |
| ROV05H201K | 200 | 130 | 170 | 355 | 8.5 | 85 | ◆ ● ▲ ■* | | | | | | | |
| ROV05H221K | 220 | 140 | 180 | 380 | 9.0 | 80 | ◆ ● ▲ ■* | | | | | | | |
| ROV05H241K | 240 | 150 | 200 | 415 | 10.5 | 75 | ◆ ● ▲ ■* | | | | | | | |
| ROV05H271K | 270 | 175 | 225 | 475 | 11.0 | 70 | ◆ ● ▲ ■* | | | | | | | |
| ROV05H301K | 300 | 195 | 250 | 525 | 12.0 | 65 | ◆ ● ▲ ■* | | | | | | | |
| ROV05H331K | 330 | 210 | 275 | 575 | 13.0 | 60 | ◆ ● ▲ ■* | | | | | | | |
| ROV05H361K | 360 | 230 | 300 | 620 | 16.0 | 70 | ◆ ● ▲ ■* | | | | | | | |
| ROV05H391K | 390 | 250 | 320 | 675 | 17.0 | 55 | ◆ ● ▲ ■* | | | | | | | |
| ROV05H431K | 430 | 275 | 350 | 745 | 20.0 | 45 | ◆ ● ▲ ■* | | | | | | | |
| ROV05H471K | 470 | 300 | 385 | 810 | 21.0 | 50 | ◆ ● ▲ ■* | | | | | | | |
| ROV05H511K | 510 | 320 | 418 | 880 | 22.0 | 50 | ◆ ● ▲ ■* | | | | | | | |
| ROV05H561K | 560 | 350 | 460 | 940 | 25.0 | 50 | ◆ ● ▲ ■* | | | | | | | |
| ROV05H621K | 620 | 385 | 505 | 1050 | 27.0 | 50 | ◆ ● ▲ ■* | | | | | | | |
| ROV05H681K | 680 | 420 | 560 | 1150 | 28.0 | 40 | ◆ ● ▲ ■* | | | | | | | |
| ROV05H751K | 750 | 460 | 615 | 1290 | 29.0 | ---- | ◆ ● ▲ ■* | | | | | | | |

* Pending VDE Recognition

1). The clamping voltage for devices ROV05H180M to ROV05H680K is tested with 1A current.

PULSE LIFETIME RATING CURVES

V-I CHARACTERISTIC CURVES

HIGH SURGE SERIES

HIGH SURGE SERIES

ROV05H180M – ROV05H680K

ROV05H180M – ROV05H680K

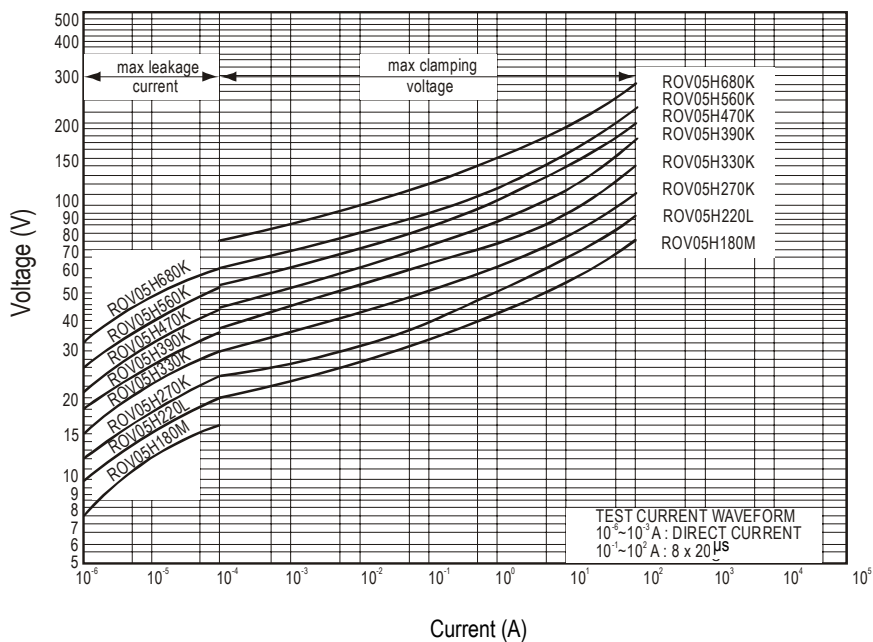
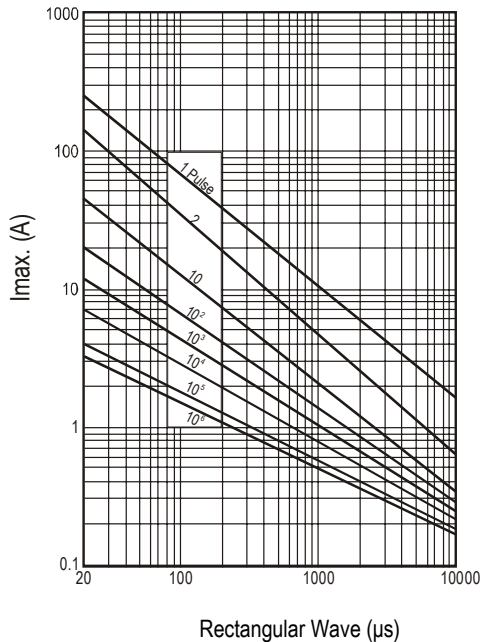

ROV05H820K – ROV05H471K

ROV05H820K – ROV05H471K

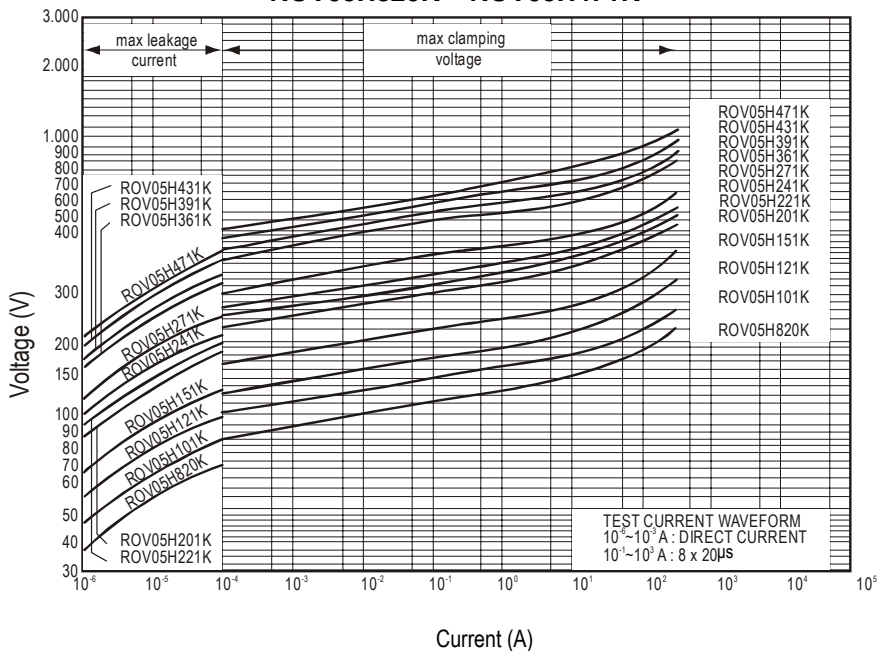
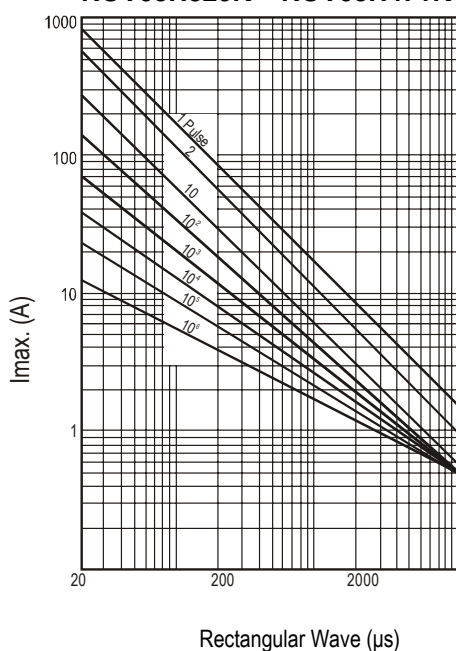

DIMENSIONS

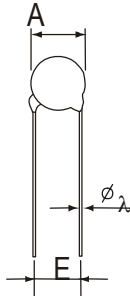

KINKED LEAD TYPE
Dimension Table

| | |
|--------------------|------|
| A max. | 7.5 |
| $\lambda \pm 0.05$ | 0.6 |
| $E \pm 1.0$ | 5.0 |
| B max. | 11.0 |
| D_1 min. | 25.0 |
| D min. | 24.0 |

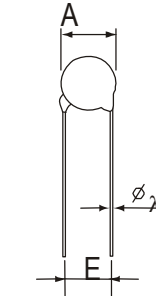
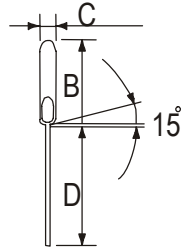

STRAIGHT LEAD TYPE (-S)
Table of C max., F, and B_1 max.

| Type No. | C max. | $F \pm 0.8$ | B_1 max. |
|----------|--------|-------------|------------|
| 180M | 4.5 | 0.8 | 10.5 |
| 220L | 4.5 | 0.9 | 10.5 |
| 270K | 4.7 | 0.9 | 10.5 |
| 330K | 4.7 | 1.0 | 10.5 |
| 390K | 4.7 | 1.2 | 10.5 |
| 470K | 5.0 | 1.2 | 10.5 |
| 560K | 5.0 | 1.4 | 10.5 |
| 680K | 5.5 | 1.7 | 10.5 |
| 820K | 3.8 | 0.8 | 10.5 |
| 101K | 3.9 | 0.8 | 10.5 |
| 121K | 4.1 | 0.9 | 10.5 |
| 151K | 4.5 | 1.2 | 10.5 |
| 181K | 4.1 | 1.0 | 10.5 |
| 201K | 4.2 | 1.0 | 10.5 |
| 221K | 4.3 | 1.1 | 10.5 |
| 241K | 4.4 | 1.1 | 10.5 |
| 271K | 4.6 | 1.3 | 10.5 |
| 301K | 4.8 | 1.3 | 10.5 |
| 331K | 4.9 | 1.3 | 10.5 |
| 361K | 5.1 | 1.8 | 10.5 |
| 391K | 5.3 | 2.0 | 11.0 |
| 431K | 6.1 | 2.1 | 11.0 |
| 471K | 6.4 | 2.2 | 11.0 |
| 511K | 6.6 | 2.5 | 11.5 |
| 561K | 6.9 | 2.8 | 11.5 |
| 621K | 7.2 | 3.1 | 11.5 |
| 681K | 7.5 | 3.4 | 11.5 |
| 751K | 7.9 | 3.7 | 11.5 |

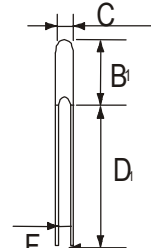

PACKAGING

in mm

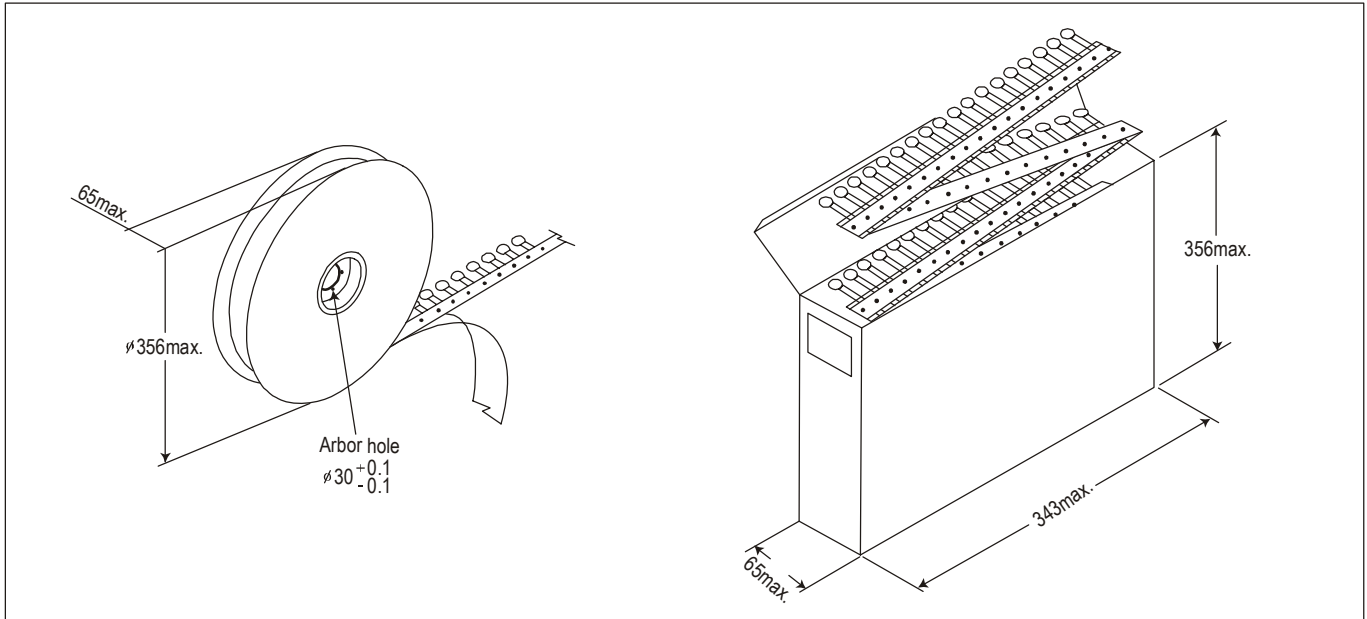

| Packaging | Bulk (box) | Reel | Ammo |
|------------------|-----------------|--------------------|-----------------|
| Box size (mm) | 290 x 155 x 110 | 350 x 350 x 108 | 330 x 240 x 46 |
| Carton size (mm) | 310 x 328 x 250 | 371 x 371 x 590 | 350 x 500 x 270 |
| One carton with | 4 Boxes | 5 Boxes (10 reels) | 10 Boxes |

| Part Number | Bulk (box) | Reel | Ammo |
|---|------------|------|------|
| ROV05-180M to ROV05-470K, ROV05H180M to ROV05H470K | 5000 | 1500 | 1500 |
| ROV05-560K to ROV05-680K, ROV05H560K to ROV05H680K | 5000 | 1500 | 1000 |
| ROV05-820K to ROV05-331K, ROV05H820K to ROV05H331K | 5000 | 1500 | 1500 |
| ROV05-361K to ROV05-391K, ROV05H361K to ROV05H391K | 5000 | 1500 | 1000 |
| ROV05-431K to ROV05-471K, ROV05H431K to ROV05H471K | 5000 | 1500 | 1000 |
| ROV05-511K to ROV05-751K, ROV05H511K to ROV05H751K | 4000 | 1000 | 1000 |

TAPE AND REEL DIMENSIONS

1/2" Pitch

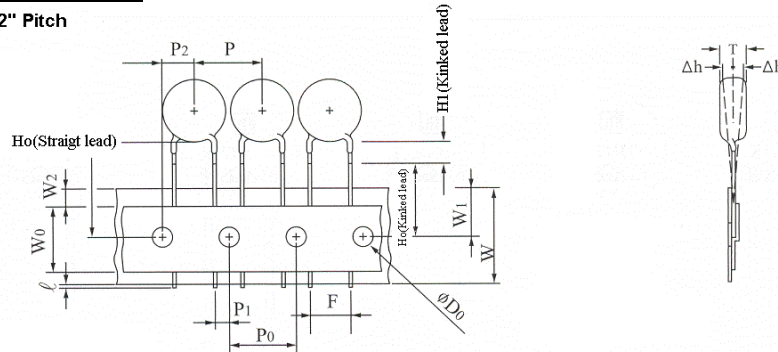

1.0" Pitch

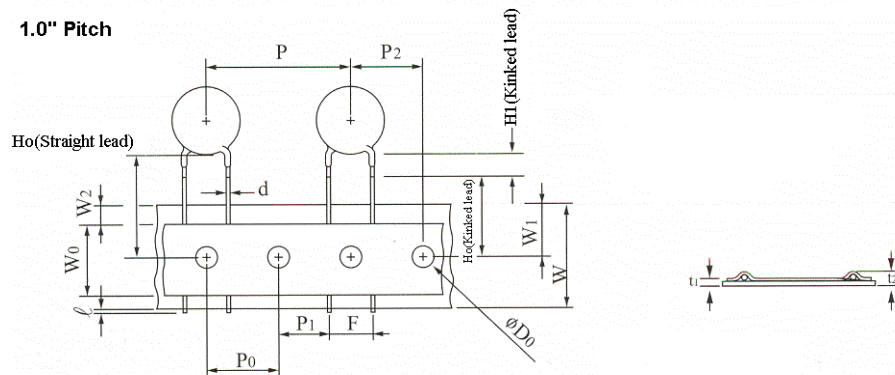

| Symbols | Item | Value |
|-----------------------|--|---|
| λ | Cut out length | 1.1mm max. |
| H_1 (Kinked lead) | Height of kink | 3.5mm max. |
| H_o (Kinked lead) | Height to seating plane | 16.0 ± 0.5mm |
| H_o (Straight lead) | Height of component from hole center | 16.0-21.0mm |
| Δh | Front to back deviation | 0.0 ± 2.0mm |
| W | Carrier tape width | 18.0 ^{+1.0} _{-0.5} mm |
| W_0 | Hold down tape width | 10.0mm |
| W_1 | Sprocket hole position | 9.0 ^{+0.75} _{-0.5} mm |
| W_2 | Adhesive tape position | 3.0mm max. |
| F | Component lead spacing | 5.0 ^{+0.8} _{-0.2} mm |
| P | Pitch of component | 12.7 ± 1.0mm |
| P_0 | Sprocket hole pitch | 12.7 ± 0.3mm |
| P_1 | Lead length from hole center to lead | 3.85 ± 0.7mm |
| P_2 | Length from hole center to disk center | 6.35 ± 1.3mm |
| D_0 | Sprocket hole diameter | 4.0 ± 0.2mm |
| d | Lead wire diameter | 0.6 ± 0.05mm |
| T | Disk thickness | See C. max table |
| t_1 | Total thickness tape | 0.7 ± 0.05mm |
| t_2 | Total thickness | 1.6mm max. |

Metal Oxide Varistors

Overvoltage Protection Device

Raychem Circuit Protection Products

PRODUCT: ROV05, R0V05H
5mm Series

DOCUMENT: SCD 25480
REV LETTER: E
REV DATE: DECEMBER 8, 2009
PAGE NO.: 10 of 10

Information furnished is believed to be accurate and reliable. However, users should independently evaluate the suitability of each product for their applications. Tyco Electronics Corporation assumes no responsibility for the use of its product or for any infringement of patents or other rights of third parties resulting from the use of its product. No license is granted by implication or otherwise under any patent or proprietary right of Tyco Electronics except the right to use such product for the purpose for which it is sold. Tyco Electronics reserves the right to change or update, without notice, any information contained in this publication; to change, without notice, the design, construction, processing, or specification of any product; and to discontinue or limit production or distribution of any product. This publication supersedes and replaces all information previously supplied. Without expressed or written consent by an officer of Tyco Electronics, Tyco Electronics does not authorize the use of any of its products as components in nuclear facility applications, aerospace, or in critical life support devices or systems. Tyco Electronics' only obligations are those in the Tyco Electronics Standard Terms and Conditions of Sale and in no case will Tyco Electronics be liable for any incidental, indirect, or consequential damages arising from the sale, resale, use, or misuse of its products.