

# NTC Thermistors

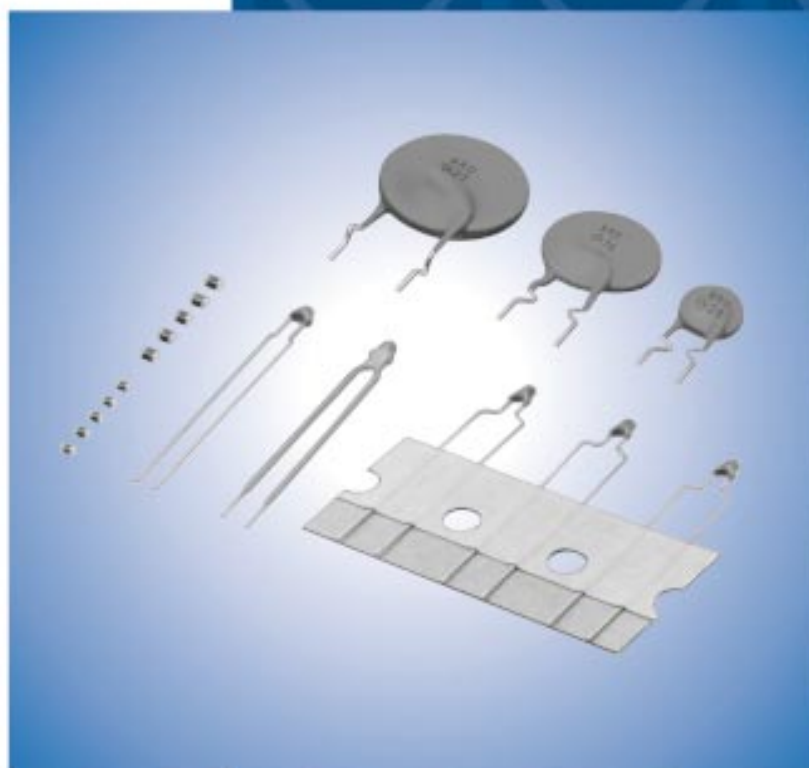

**muRata**

*Innovator  
in Electronics*

Murata  
Manufacturing Co., Ltd.

Cat.No.R44E-9

# CONTENTS

1

Part Numbering	2
Basic Characteristics	5
1 for Temperature Compensation 0201 (0603) Size	6
2 for Temperature Compensation 0402 (1005) Size	8
3 for Temperature Compensation 0603 (1608) Size	10
4 for Temperature Compensation 0805 (2012) Size	12
for Temperature Compensation Temperature Characteristics (Center Value)	14
Chip Type ⚠Caution/Notice	17
Chip Type Package	20
5 for Temperature Sensor Lead Type	23
6 for Temperature Sensor Lead Insulation Type	24
for Temperature Sensor Temperature Characteristics (Center Value)	26
for Temperature Sensor Lead Type/Lead Insulation Type ⚠Caution/Notice	27
for Temperature Sensor Lead Type/Lead Insulation Type NTSA/NTSD Series Package	28
7 for Inrush Current Suppression Lead Type	29
● Current-R Ratio (RT/R25) / Current-Temperature Characteristics (Typical)	31
● for Inrush Current Suppression Lead Type ⚠Caution / Notice	35
● for Inrush Current Suppression Lead Type Package	37

2

3

4

5

6

7

● Part Numbering

NTC Thermistors for Temp. Sensor and Compensation Chip Type

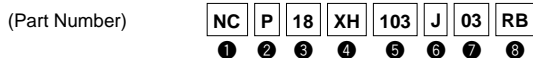

① Product ID

Product ID	
<b>NC</b>	NTC Thermistors Chip Type

② Series

Code	Series
<b>P</b>	Plated Termination Series

③ Dimensions (L×W)

Code	Dimensions (L×W)	EIA
<b>03</b>	0.60×0.30mm	0201
<b>15</b>	1.00×0.50mm	0402
<b>18</b>	1.60×0.80mm	0603
<b>21</b>	2.00×1.25mm	0805

④ Temperature Characteristics

Code	Temperature Characteristics
<b>WB</b>	Nominal B-Constant 4050—4099K
<b>WD</b>	Nominal B-Constant 4150—4199K
<b>WF</b>	Nominal B-Constant 4250—4299K
<b>WL</b>	Nominal B-Constant 4450—4499K
<b>WM</b>	Nominal B-Constant 4500—4549K
<b>XC</b>	Nominal B-Constant 3100—3149K
<b>XF</b>	Nominal B-Constant 3250—3299K
<b>XQ</b>	Nominal B-Constant 3650—3699K
<b>XH</b>	Nominal B-Constant 3350—3399K
<b>XM</b>	Nominal B-Constant 3500—3549K
<b>XV</b>	Nominal B-Constant 3900—3949K
<b>XW</b>	Nominal B-Constant 3950—3999K

⑤ Resistance

Expressed by three figures. The unit is ohm ( $\Omega$ ). The first and second figures are significant digits, and the third figure expresses the number of zeros which follow the two figures. If there is a decimal point, it is expressed by the capital letter "R". In this case, all figures are significant digits.

Ex.)

Code	Resistance
<b>102</b>	1k $\Omega$
<b>103</b>	10k $\Omega$
<b>104</b>	100k $\Omega$

⑥ Resistance Tolerance

Code	Resistance Tolerance
<b>E</b>	±3%
<b>F</b>	±1%
<b>J</b>	±5%
<b>K</b>	±10%

⑦ Individual Specifications

Structures and others are expressed by two figures.

Code	Individual Specifications
<b>03</b>	Standard Type

Please contact us for details.

⑧ Packaging

Code	Packaging
<b>RA</b>	Plastic Taping 4mm Pitch
<b>RB</b>	Paper Taping 4mm Pitch
<b>RC</b>	Paper Taping 2mm Pitch (10000 pcs.)
<b>RL</b>	Paper Taping 2mm Pitch (15000 pcs.)

## NTC Thermistors for Temp. Sensor and Compensation Lead Type

(Part Number)

<b>NT</b>	<b>SA0</b>	<b>XH</b>	<b>103</b>	<b>F</b>	<b>E1</b>	<b>B0</b>
①	②	③	④	⑤	⑥	⑦

### ① Product ID

Product ID	
<b>NT</b>	NTC Thermistors

### ② Series

Code	Series
<b>SA0</b>	for Temperature Sensors No Lead-coating Type
<b>SD0</b>	for Temperature Sensors Lead-coating Type (Total Length 30mm max.)
<b>SD1</b>	for Temperature Sensors Lead-coating Type (Total Length 30 to 50mm)

### ③ Temperature Characteristics

Code	Temperature Characteristics
<b>WB</b>	Nominal B-Constant 4050–4099K
<b>WC</b>	Nominal B-Constant 4100–4149K
<b>WD</b>	Nominal B-Constant 4150–4199K
<b>WF</b>	Nominal B-Constant 4250–4299K
<b>XM</b>	Nominal B-Constant 3500–3549K
<b>XH</b>	Nominal B-Constant 3350–3399K
<b>XR</b>	Nominal B-Constant 3700–3749K
<b>XV</b>	Nominal B-Constant 3900–3949K

### ④ Resistance

Expressed by three figures. The unit is ohm ( $\Omega$ ). The first and second figures are significant digits, and the third figure expresses the number of zeros which follow the two figures. If there is a decimal point, it is expressed by the capital letter "R". In this case, all figures are significant digits.

Ex.)

Code	Resistance
<b>202</b>	2k $\Omega$
<b>203</b>	20k $\Omega$

### ⑤ Resistance Tolerance

Code	Resistance Tolerance
<b>E</b>	$\pm 3\%$
<b>F</b>	$\pm 1\%$

### ⑥ Individual Specifications

A lead structure and other specifications are expressed by two digits.

Code	Individual Specifications
<b>E1</b>	Standard Bulk ( <b>NTSA</b> , <b>NTSD0</b> Series)
<b>N6</b>	Standard Taping ( <b>NTSA</b> Series)
<b>PB</b>	Standard Bulk ( <b>NTSD1</b> Series)

### ⑦ Packaging (NTSA/NTSD0 Series)

Code	Packaging
<b>A0</b>	Ammo Pack
<b>B0</b>	Bulk

### ⑦ Total Length (NTSD1 Series)

Code	Total Length
<b>30</b>	30mm
<b>40</b>	40mm
<b>50</b>	50mm

## NTC Thermistors for Inrush Current Suppression

(Part Number)

<b>NT</b>	<b>PA7</b>	<b>160</b>	<b>L</b>	<b>BM</b>	<b>B0</b>
①	②	③	④	⑤	⑥

### ① Product ID

Product ID	
<b>NT</b>	NTC Thermistors

### ② Series

Code	Series	Nominal Body Diameter
<b>PA7</b>	Inrush Current Suppression Lead Type	ø7mm
<b>PA9</b>		ø9mm
<b>PAA</b>		ø10mm
<b>PAD</b>		ø13mm
<b>PAJ</b>		ø18mm
<b>PAN</b>		ø22mm

### ③ Resistance

Expressed by three figures. The unit is ohm ( $\Omega$ ). The first and second figures are significant digits, and the third figure expresses the number of zeros which follow the two figures. If there is a decimal point, it is expressed by the capital letter "R". In this case, all figures are significant digits.

Ex.)

Code	Resistance
<b>3R0</b>	3 $\Omega$
<b>100</b>	10 $\Omega$

### ④ Resistance Tolerance

Code	Resistance Tolerance
<b>L</b>	$\pm 15\%$

### ⑤ Individual Specifications

A lead structure and other specifications are expressed by two capital letters.

Code	Individual Specifications	Body Diameter
<b>DK</b>	Standard Type	ø18mm, ø22mm
<b>DN</b>	Standard Type	ø10mm, ø13mm
<b>BM</b>	Standard Type	ø7mm, ø9mm

### ⑥ Packaging

Code	Packaging
<b>A0</b>	Ammo Pack
<b>B0</b>	Bulk

## Basic Characteristics

### Basic Characteristics

#### 1. Zero-power Resistance of Thermistor : R

$$R=R_0 \exp B (1/T-1/T_0) \dots\dots\dots(1)$$

R : Resistance in ambient temperature T (K)  
(K : absolute temperature)

R<sub>0</sub> : Resistance in ambient temperature T<sub>0</sub> (K)

B : B-constant of Thermistor

#### 2. B-Constant

as (1) formula

$$B= \ell n (R/R_0) / (1/T-1/T_0) \dots\dots\dots(2)$$

#### 3. Thermal Dissipation Constant

When electric power P (mW) is spent in ambient temperature T<sub>1</sub> and thermistor temperature rises T<sub>2</sub>, there is a formula as follows

$$P=C (T_2-T_1) \dots\dots\dots(3)$$

C : Thermal dissipation constant (mW/°C)

Thermal dissipation constant is varied with dimensions, measurement conditions, etc.

#### 4. Thermal Time Constant

Period in which Thermistor's temperature will change 63.2% of its temperature difference from ambient temperature T<sub>0</sub> (°C) to T<sub>1</sub> (°C).

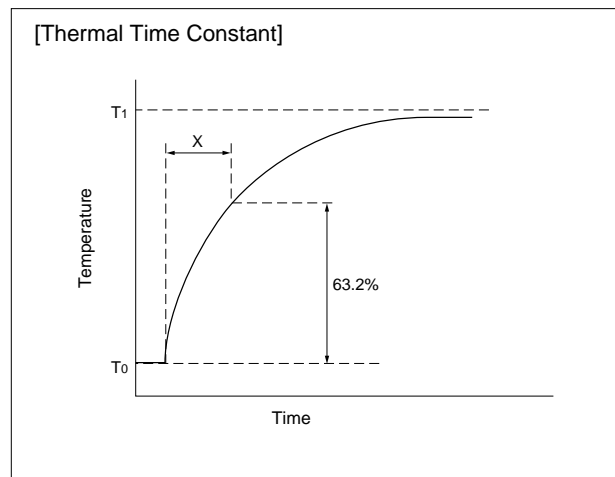
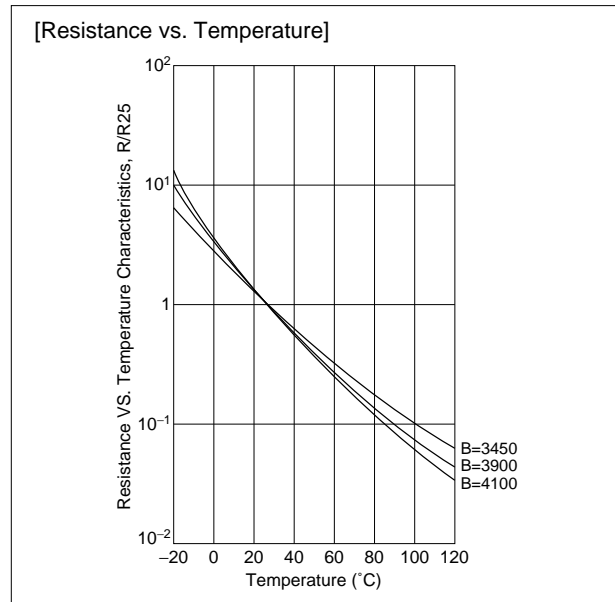

### Performance

Item	Condition
Resistance	Measured by zero-power in specified ambient temperature.
B-Constant	Calculated between two specified ambient temperatures by next formula. T and T <sub>0</sub> is absolute temperature (K). $B = \frac{\ell n (R/R_0)}{1/T - 1/T_0}$
Thermal Dissipation Constant	Shows necessary electric power that Thermistor's temperature rises 1°C by self heating. It is calculated by next formula. (mW/°C) $C = \frac{P}{T - T_0}$
Rated Electric Power	Shows necessary electric power that Thermistor's temperature rises 100°C by self heating in ambient temperature 25°C.
Permissive Operating Current	It is possible to keep Thermistor's temperature rising max. 1°C

Please inquire about test conditions and ratings.

# NTC Thermistors



## for Temperature Compensation 0201 (0603) Size

0201/0402/0603/0805 sized Chip NTC Thermistor have Ni barrier termination and provide excellent solderability and offer high stability in environment by unique inner construction.

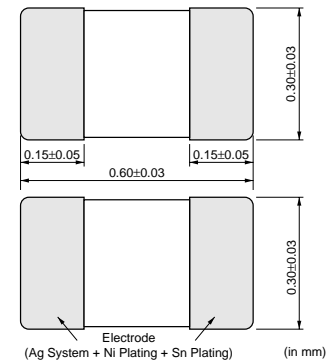

### ■ Features

1. Excellent solderability and high stability in environment
2. Excellent long time aging stability
3. High accuracy in resistance and B-constant
4. Reflow soldering possible
5. Lead is not contained in the product.

### ■ Applications

1. Temperature compensation of transistor, IC, crystal oscillator of mobile communications equipment
2. Temperature sensor for rechargeable batteries
3. Temperature compensation of LCD
4. Temperature compensation and sensing of car audio equipment (CD, MD, Tuner)
5. Temperature compensation of several kinds of circuits

Part Number	Resistance (25°C)	B-Constant (25-50°C) (K)	Permissible Operating Current (25°C) (mA)	Rated Electric Power (25°C) (mW)	Typical Dissipation Constant (25°C) (mW/°C)	Operating Temperature Range (°C)
NCP03YS110□05RL	11ohm	2750 ±3%	9.50	100	1.0	-40 to 125
NCP03YS220□05RL	22ohm	2750 ±3%	6.70	100	1.0	-40 to 125
NCP03YS330□05RL	33ohm	2750 ±3%	5.50	100	1.0	-40 to 125
NCP03YS470□05RL	47ohm	2750 ±3%	4.60	100	1.0	-40 to 125
NCP03YS680□05RL	68ohm	2750 ±3%	3.80	100	1.0	-40 to 125
NCP03YS101□05RL	100ohm	2750 ±3%	3.10	100	1.0	-40 to 125
NCP03XH682□05RL	6.8k ohm	3380 ±3%	0.38	100	1.0	-40 to 125
NCP03XH103□05RL	10k ohm	3380 ±3%	0.31	100	1.0	-40 to 125
NCP03XH153□05RL	15k ohm	3380 ±3%	0.25	100	1.0	-40 to 125
NCP03XH223□05RL	22k ohm	3380 ±3%	0.21	100	1.0	-40 to 125
NCP03WF333□05RL	33k ohm	4250 ±3%	0.17	100	1.0	-40 to 125
NCP03WB473□05RL	47k ohm	4050 ±3%	0.14	100	1.0	-40 to 125
NCP03WL473□05RL	47k ohm	4485 ±3%	0.14	100	1.0	-40 to 125
NCP03WF683□05RL	68k ohm	4250 ±3%	0.12	100	1.0	-40 to 125
NCP03WL683□05RL	68k ohm	4485 ±3%	0.12	100	1.0	-40 to 125
NCP03WF104□05RL	100k ohm	4250 ±3%	0.10	100	1.0	-40 to 125
NCP03WL104□05RL	100k ohm	4485 ±3%	0.10	100	1.0	-40 to 125
NCP03WL154□05RL	150k ohm	4485 ±3%	0.08	100	1.0	-40 to 125
NCP03WL224□05RL	220k ohm	4485 ±3%	0.06	100	1.0	-40 to 125

A blank column is filled with resistance tolerance codes. (J: ±5%, K: ±10%)

## ■ Standard Land Dimensions

1

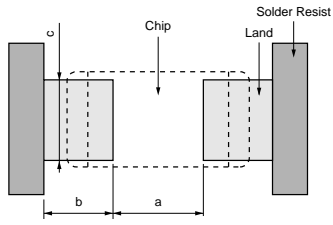

Soldering Methods	a	b	c
Reflow Soldering	0.25	0.25	0.3

(in mm)



# NTC Thermistors



## for Temperature Compensation 0402 (1005) Size

2

0201/0402/0603/0805 sized Chip NTC Thermistors have Ni barrier termination and provide excellent solderability and offer high stability in environment by unique inner construction.

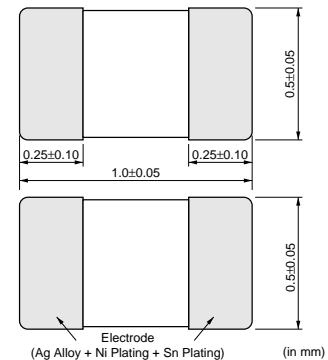
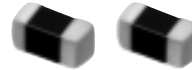

### ■ Features

1. Excellent solderability and high stability in environment
2. Excellent long time aging stability
3. High accuracy in resistance and B-constant
4. Reflow soldering possible
5. Same B-constant in the same resistance in the three sizes (0805/0603/0402)  
Easy to use smaller size in the circuits
6. Lead is not contained in the product.
7. NCP15/18/21 series are recognized by UL (UL1434, File No. E137188 Vol. 2, Sec. 2)

### ■ Applications

1. Temperature compensation of transistor, IC, crystal oscillator of mobile communications equipment
2. Temperature sensor for rechargeable batteries
3. Temperature compensation of LCD
4. Temperature compensation and sensing of car audio equipment (CD, MD, Tuner)
5. Temperature compensation of several kinds of circuits

Part Number	Resistance (25°C)	B-Constant (25-50°C) (K)	Permissible Operating Current (25°C) (mA)	Rated Electric Power (25°C) (mW)	Typical Dissipation Constant (25°C) (mW/°C)	Operating Temperature Range (°C)
NCP15XC220□03RC	22ohm	3100 ±3%	6.70	100	1.0	-40 to 125
NCP15XC330□03RC	33ohm	3100 ±3%	5.50	100	1.0	-40 to 125
NCP15XC470□03RC	47ohm	3100 ±3%	4.60	100	1.0	-40 to 125
NCP15XC680□03RC	68ohm	3100 ±3%	3.80	100	1.0	-40 to 125
NCP15XF101□03RC	100ohm	3250 ±3%	3.10	100	1.0	-40 to 125
NCP15XF151□03RC	150ohm	3250 ±3%	2.50	100	1.0	-40 to 125
NCP15XM221□03RC	220ohm	3500 ±3%	2.10	100	1.0	-40 to 125
NCP15XM331□03RC	330ohm	3500 ±3%	1.70	100	1.0	-40 to 125
NCP15XQ471□03RC	470ohm	3650 ±2%	1.40	100	1.0	-40 to 125
NCP15XQ681□03RC	680ohm	3650 ±3%	1.20	100	1.0	-40 to 125
NCP15XQ102□03RC	1.0k ohm	3650 ±2%	1.00	100	1.0	-40 to 125
NCP15XW152□03RC	1.5k ohm	3950 ±3%	0.81	100	1.0	-40 to 125
NCP15XW222□03RC	2.2k ohm	3950 ±3%	0.67	100	1.0	-40 to 125
NCP15XW332□03RC	3.3k ohm	3950 ±3%	0.55	100	1.0	-40 to 125
NCP15XM472□03RC	4.7k ohm	3500 ±2%	0.46	100	1.0	-40 to 125
NCP15XW682□03RC	6.8k ohm	3950 ±3%	0.38	100	1.0	-40 to 125
NCP15XH103□03RC	10k ohm	3380 ±1%	0.31	100	1.0	-40 to 125
NCP15XV103□03RC	10k ohm	3900 ±3%	0.31	100	1.0	-40 to 125
NCP15XW153□03RC	15k ohm	3950 ±3%	0.25	100	1.0	-40 to 125
NCP15XW223□03RC	22k ohm	3950 ±3%	0.21	100	1.0	-40 to 125
NCP15WL223□03RC	22k ohm	4485 ±1%	0.21	100	1.0	-40 to 125
NCP15WB333□03RC	33k ohm	4050 ±3%	0.17	100	1.0	-40 to 125

Continued on the following page.

Continued from the preceding page.

Part Number	Resistance (25°C)	B-Constant (25-50°C) (K)	Permissible Operating Current (25°C) (mA)	Rated Electric Power (25°C) (mW)	Typical Dissipation Constant (25°C) (mW/°C)	Operating Temperature Range (°C)
NCP15WL333□03RC	33k ohm	4485 ±1%	0.17	100	1.0	-40 to 125
NCP15WB473□03RC	47k ohm	4050 ±1%	0.14	100	1.0	-40 to 125
NCP15WL473□03RC	47k ohm	4485 ±1%	0.14	100	1.0	-40 to 125
NCP15WD683□03RC	68k ohm	4150 ±3%	0.12	100	1.0	-40 to 125
NCP15WL683□03RC	68k ohm	4485 ±1%	0.12	100	1.0	-40 to 125
NCP15WF104□03RC	100k ohm	4250 ±1%	0.10	100	1.0	-40 to 125
NCP15WL104□03RC	100k ohm	4485 ±1%	0.10	100	1.0	-40 to 125
NCP15WM154□03RC	150k ohm	4500 ±3%	0.08	100	1.0	-40 to 125
NCP15WL154□03RC	154k ohm	4485 ±1%	0.08	100	1.0	-40 to 125
NCP15WM224□03RC	220k ohm	4500 ±3%	0.06	100	1.0	-40 to 125
NCP15WM474□03RC	470k ohm	4500 ±3%	0.04	100	1.0	-40 to 125

A blank column is filled with resistance tolerance codes. (J: ±5%, K: ±10%)

Tolerance ±1% is also available for the following type.

10k ohm: NCP15XH103F03RC

47k ohm: NCP15WB473F03RC

100k ohm: NCP15WF104F03RC

## Standard Land Dimensions

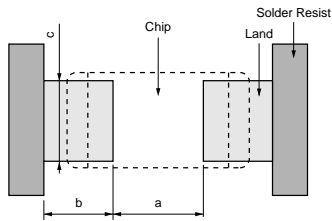

Soldering Methods	a	b	c
Reflow Soldering	0.4	0.4-0.5	0.5

(in mm)

# NTC Thermistors



## for Temperature Compensation 0603 (1608) Size

0201/0402/0603/0805 sized Chip NTC Thermistors have Ni barrier termination and provide excellent solderability and offer high stability in environment by unique inner construction.

### ■ Features

1. Excellent solderability and high stability in environment
2. Excellent long time aging stability
3. High accuracy in resistance and B-constant
4. Flow/Reflow soldering possible
5. Same B-constant in the same resistance in the three sizes (0805/0603/0402)  
Easy to use smaller size in the circuits
6. Lead is not contained in the product
7. NCP15/18/21 series are recognized by UL (UL1434, File No. E137188 Vol. 2, Sec. 2)

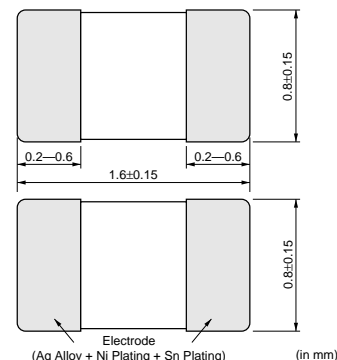

3

### ■ Applications

1. Temperature compensation of transistor, IC, crystal oscillator of mobile communications equipment
2. Temperature sensor for rechargeable batteries
3. Temperature compensation of LCD
4. Temperature compensation and sensing of car audio equipment (CD, MD, Tuner)
5. Temperature compensation of several kinds of circuits

Part Number	Resistance (25°C)	B-Constant (25-50°C) (K)	Permissible Operating Current (25°C) (mA)	Rated Electric Power (25°C) (mW)	Typical Dissipation Constant (25°C) (mW/°C)	Operating Temperature Range (°C)
NCP18XF101□03RB	100ohm	3250 ±3%	3.10	100	1.0	-40 to 125
NCP18XF151□03RB	150ohm	3250 ±3%	2.50	100	1.0	-40 to 125
NCP18XM221□03RB	220ohm	3500 ±3%	2.10	100	1.0	-40 to 125
NCP18XM331□03RB	330ohm	3500 ±3%	1.70	100	1.0	-40 to 125
NCP18XQ471□03RB	470ohm	3650 ±2%	1.40	100	1.0	-40 to 125
NCP18XQ681□03RB	680ohm	3650 ±3%	1.20	100	1.0	-40 to 125
NCP18XQ102□03RB	1.0k ohm	3650 ±2%	1.00	100	1.0	-40 to 125
NCP18XW152□03RB	1.5k ohm	3950 ±3%	0.81	100	1.0	-40 to 125
NCP18XW222□03RB	2.2k ohm	3950 ±3%	0.67	100	1.0	-40 to 125
NCP18XW332□03RB	3.3k ohm	3950 ±3%	0.55	100	1.0	-40 to 125
NCP18XM472□03RB	4.7k ohm	3500 ±2%	0.46	100	1.0	-40 to 125
NCP18XW682□03RB	6.8k ohm	3950 ±3%	0.38	100	1.0	-40 to 125
NCP18XH103□03RB	10k ohm	3380 ±1%	0.31	100	1.0	-40 to 125
NCP18XW153□03RB	15k ohm	3950 ±3%	0.25	100	1.0	-40 to 125
NCP18XW223□03RB	22k ohm	3950 ±3%	0.21	100	1.0	-40 to 125
NCP18WB333□03RB	33k ohm	4050 ±3%	0.17	100	1.0	-40 to 125
NCP18WB473□03RB	47k ohm	4050 ±2%	0.14	100	1.0	-40 to 125
NCP18WD683□03RB	68k ohm	4150 ±3%	0.12	100	1.0	-40 to 125
NCP18WF104□03RB	100k ohm	4250 ±2%	0.10	100	1.0	-40 to 125
NCP18WM154□03RB	150k ohm	4500 ±3%	0.08	100	1.0	-40 to 125
NCP18WM224□03RB	220k ohm	4500 ±3%	0.06	100	1.0	-40 to 125
NCP18WM474□03RB	470k ohm	4500 ±3%	0.04	100	1.0	-40 to 125

A blank column is filled with resistance tolerance codes. (J: ±5%, K: ±10%)  
Tolerance ±1% NCP18XH103F03RB is also available for 10k ohm type.



## ■ Standard Land Dimensions

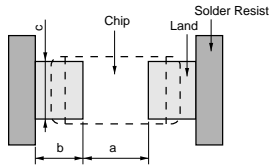

Soldering Methods	a	b	c
Flow Soldering	0.6-1.0	0.8-0.9	0.6-0.8
Reflow Soldering	0.6-0.8	0.6-0.7	0.6-0.8

(in mm)

# NTC Thermistors



## for Temperature Compensation 0805 (2012) Size

0201/0402/0603/0805 sized Chip NTC Thermistors have Ni barrier termination and provide excellent solderability and offer high stability in environment by unique inner construction.

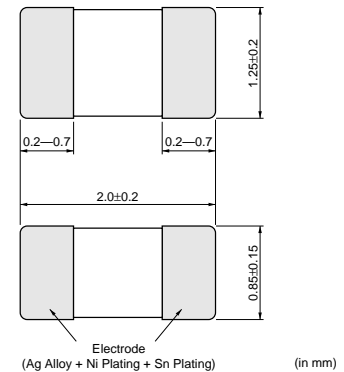

### ■ Features

1. Excellent solderability and high stability in environment
2. Excellent long time aging stability
3. High accuracy in resistance and B-constant
4. Flow/Reflow soldering possible
5. Same B-constant in the same resistance in the three sizes (0805/0603/0402)  
Easy to use smaller size in the circuits
6. Lead is not contained in the product
7. NCP15/18/21 series are recognized by UL  
(UL1434, File No. E137188 Vol. 2, Sec. 2)

4

### ■ Applications

1. Temperature compensation of transistor, IC, crystal oscillator of mobile communications equipment
2. Temperature sensor for rechargeable batteries
3. Temperature compensation of LCD
4. Temperature compensation and sensing of car audio equipment (CD, MD, Tuner)
5. Temperature compensation of several kinds of circuits

Part Number	Resistance (25°C)	B-Constant (25-50°C) (K)	Permissible Operating Current (25°C) (mA)	Rated Electric Power (25°C) (mW)	Typical Dissipation Constant (25°C) (mW/°C)	Operating Temperature Range (°C)
NCP21XM221□03RA	220ohm	3500 ±3%	3.00	200	2.0	-40 to 125
NCP21XQ471□03RA	470ohm	3650 ±3%	2.00	200	2.0	-40 to 125
NCP21XQ102□03RA	1.0k ohm	3650 ±3%	1.40	200	2.0	-40 to 125
NCP21XW222□03RA	2.2k ohm	3950 ±3%	0.90	200	2.0	-40 to 125
NCP21XM472□03RA	4.7k ohm	3500 ±3%	0.65	200	2.0	-40 to 125
NCP21XV103□03RA	10k ohm	3900 ±3%	0.44	200	2.0	-40 to 125
NCP21XW153□03RA	15k ohm	3950 ±3%	0.36	200	2.0	-40 to 125
NCP21XW223□03RA	22k ohm	3950 ±3%	0.30	200	2.0	-40 to 125
NCP21WB333□03RA	33k ohm	4050 ±3%	0.24	200	2.0	-40 to 125
NCP21WB473□03RA	47k ohm	4050 ±3%	0.20	200	2.0	-40 to 125
NCP21WF104□03RA	100k ohm	4250 ±3%	0.14	200	2.0	-40 to 125

A blank column is filled with resistance tolerance codes. (J: ±5%, K: ±10%)

## ■ Standard Land Dimensions

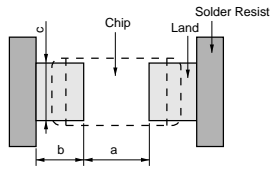

Soldering Methods	a	b	c
Flow Soldering	1.0-1.1	0.9-1.0	1.0-1.2
Reflow Soldering	1.0-1.1	0.6-0.7	1.0-1.2

(in mm)

## for Temperature Compensation Temperature Characteristics (Center Value)

Part Number	NCP□□YS110	NCP□□YS220	NCP□□XC220	NCP□□YS330	NCP□□XC330	NCP□□YS470	NCP□□XC470	NCP□□YS680
Resistance	11Ω	22Ω	22Ω	33Ω	33Ω	47Ω	47Ω	68Ω
B-Constant	2750K	2750K	3100K	2750K	3100K	2750K	3100K	2750K
Temp. (°C)	Resistance (Ω)	Resistance (Ω)	Resistance (Ω)	Resistance (Ω)	Resistance (Ω)	Resistance (Ω)	Resistance (Ω)	Resistance (Ω)
-40	127.366	254.732	355.823	382.098	533.734	544.201	760.166	787.354
-35	101.662	203.325	273.975	304.987	410.962	434.376	585.310	628.459
-30	81.726	163.452	213.003	245.178	319.504	349.193	455.051	505.215
-25	66.148	132.296	166.943	198.444	250.415	282.633	356.652	408.915
-20	53.946	107.893	131.997	161.839	197.996	230.498	281.994	333.487
-15	44.273	88.546	105.318	132.819	157.978	189.167	224.998	273.688
-10	36.494	72.987	84.670	109.481	127.005	155.927	180.886	225.597
-5	30.262	60.523	68.628	90.785	102.942	129.299	146.614	187.071
0	25.226	50.451	55.981	75.677	83.972	107.782	119.596	155.940
5	21.150	42.300	45.859	63.449	68.789	90.367	97.972	130.744
10	17.828	35.657	37.819	53.485	56.728	76.176	80.794	110.212
15	15.103	30.205	31.396	45.308	47.094	64.529	67.073	93.361
20	12.859	25.719	26.211	38.578	39.317	54.944	55.997	79.494
25	11.000	22.000	22.000	33.000	33.000	47.000	47.000	68.000
30	9.452	18.904	18.560	28.356	27.840	40.386	39.651	58.430
35	8.162	16.323	15.735	24.485	23.603	34.872	33.616	50.454
40	7.077	14.155	13.403	21.232	20.104	30.239	28.633	43.750
45	6.161	12.323	11.462	18.484	17.193	26.326	24.487	38.089
50	5.389	10.778	9.842	16.167	14.763	23.025	21.026	33.313
55	4.731	9.461	8.488	14.192	12.732	20.213	18.133	29.244
60	4.168	8.336	7.348	12.504	11.022	17.809	15.698	25.766
65	3.687	7.374	6.399	11.061	9.598	15.753	13.670	22.792
70	3.273	6.545	5.595	9.817	8.392	13.982	11.952	20.230
75	2.915	5.830	4.896	8.744	7.345	12.454	10.461	18.019
80	2.605	5.210	4.299	7.814	6.448	11.130	9.184	16.102
85	2.335	4.671	3.795	7.006	5.692	9.979	8.107	14.437
90	2.100	4.201	3.360	6.301	5.040	8.974	7.179	12.984
95	1.894	3.789	2.983	5.683	4.474	8.094	6.373	11.710
100	1.713	3.427	2.656	5.140	3.983	7.320	5.673	10.591
105	1.554	3.107	2.367	4.661	3.551	6.638	5.057	9.604
110	1.412	2.825	2.116	4.237	3.173	6.035	4.520	8.731
115	1.287	2.574	1.901	3.862	2.851	5.500	4.060	7.957
120	1.176	2.352	1.712	3.528	2.568	5.024	3.657	7.269
125	1.077	2.153	1.543	3.230	2.314	4.600	3.296	6.655

Part Number	NCP□□XC680	NCP□□YS101	NCP□□XF101	NCP□□XF151	NCP□□XM221	NCP□□XM331	NCP□□XQ471	NCP□□XQ681
Resistance	68Ω	100Ω	100Ω	150Ω	220Ω	330Ω	470Ω	680Ω
B-Constant	3100K	2750K	3250K	3250K	3500K	3500K	3650K	3650K
Temp. (°C)	Resistance (Ω)	Resistance (Ω)	Resistance (Ω)	Resistance (Ω)	Resistance (Ω)	Resistance (Ω)	Resistance (Ω)	Resistance (Ω)
-40	1099.815	1157.874	1824.175	2736.262	4947.904	7421.856	11822.473	17104.854
-35	846.832	924.204	1390.685	2086.028	3703.755	5555.632	8767.745	12685.248
-30	658.372	742.963	1070.653	1605.979	2798.873	4198.309	6570.224	9505.855
-25	516.007	601.346	831.138	1246.708	2135.887	3203.831	4971.784	7193.219
-20	407.991	490.422	650.960	976.440	1645.037	2467.555	3796.933	5493.436
-15	325.529	402.482	514.441	771.661	1278.034	1917.051	2923.400	4229.599
-10	261.707	331.760	409.700	614.550	1000.620	1500.930	2269.599	3283.675
-5	212.123	275.105	328.877	493.315	789.612	1184.418	1775.225	2568.411
0	173.033	229.324	265.759	398.639	627.752	941.628	1399.050	2024.158
5	141.747	192.270	215.785	323.677	502.474	753.711	1110.220	1606.275
10	116.894	162.076	176.395	264.592	405.010	607.514	887.257	1283.691
15	97.042	137.296	145.161	217.742	328.480	492.720	713.463	1032.245
20	81.016	116.902	120.152	180.228	268.044	402.066	577.375	835.351
25	68.000	100.000	100.000	150.000	220.000	330.000	470.000	680.000
30	57.368	85.927	83.669	125.503	181.576	272.365	384.800	556.733
35	48.636	74.197	70.361	105.541	150.668	226.002	316.757	458.287
40	41.426	64.339	59.456	89.184	125.681	188.521	262.177	379.320
45	35.428	56.013	50.470	75.705	105.336	158.004	218.069	315.504
50	30.421	48.989	43.029	64.543	88.717	133.076	182.297	263.749
55	26.235	43.006	36.830	55.246	75.059	112.588	153.150	221.579
60	22.712	37.891	31.649	47.473	63.777	95.666	129.249	186.998
65	19.778	33.517	27.364	41.045	54.415	81.622	109.551	158.499
70	17.293	29.750	23.756	35.634	46.631	69.946	93.281	134.960
75	15.134	26.498	20.651	30.976	40.115	60.172	79.750	115.383
80	13.288	23.680	18.011	27.016	34.637	51.955	68.446	99.029
85	11.729	21.231	15.800	23.700	30.013	45.019	58.996	85.356
90	10.386	19.094	13.908	20.862	26.110	39.165	51.036	73.839
95	9.220	17.221	12.263	18.394	22.790	34.186	44.332	64.140
100	8.208	15.575	10.844	16.265	19.957	29.935	38.640	55.905
105	7.317	14.124	9.622	14.434	17.541	26.312	33.790	48.888
110	6.539	12.840	8.563	12.844	15.453	23.180	29.664	42.918
115	5.874	11.702	7.648	11.472	13.663	20.494	26.123	37.795
120	5.291	10.690	6.850	10.275	12.114	18.171	23.091	33.409
125	4.768	9.787	6.162	9.243	10.778	16.168	20.472	29.618

Continued on the following page.

## for Temperature Compensation Temperature Characteristics (Center Value)

↳ Continued from the preceding page.

Part Number	NCP□□XQ102	NCP□□XW152	NCP□□XW222	NCP□□XW332	NCP□□XM472	NCP□□XH682	NCP□□XW682	NCP□□XH103
Resistance	1kΩ	1.5kΩ	2.2kΩ	3.3kΩ	4.7kΩ	6.8kΩ	6.8kΩ	10kΩ
B-Constant	3650K	3950K	3950K	3950K	3500K	3380K	3950K	3380K
Temp. (°C)	Resistance (kΩ)	Resistance (kΩ)	Resistance (kΩ)	Resistance (kΩ)	Resistance (kΩ)	Resistance (kΩ)	Resistance (kΩ)	Resistance (kΩ)
-40	25.154	51.791	75.961	113.941	105.705	133.122	234.787	195.652
-35	18.655	37.172	54.520	81.779	79.126	100.810	168.515	148.171
-30	13.979	27.005	39.607	59.411	59.794	77.113	122.422	113.347
-25	10.578	19.843	29.103	43.654	45.630	59.566	89.953	87.559
-20	8.079	14.728	21.601	32.401	35.144	46.419	66.766	68.237
-15	6.220	11.044	16.198	24.297	27.303	36.494	50.066	53.650
-10	4.829	8.362	12.264	18.396	21.377	28.913	37.906	42.506
-5	3.777	6.389	9.370	14.055	16.869	23.052	28.963	33.892
0	2.977	4.922	7.219	10.829	13.411	18.512	22.313	27.219
5	2.362	3.825	5.609	8.414	10.735	14.977	17.338	22.021
10	1.888	2.994	4.391	6.586	8.653	12.191	13.571	17.926
15	1.518	2.361	3.463	5.195	7.018	9.979	10.705	14.674
20	1.229	1.876	2.751	4.126	5.726	8.215	8.503	12.081
25	1.000	1.500	2.200	3.300	4.700	6.800	6.800	10.000
30	0.819	1.207	1.771	2.656	3.879	5.654	5.474	8.315
35	0.674	0.978	1.434	2.152	3.219	4.724	4.434	6.948
40	0.558	0.797	1.169	1.753	2.685	3.967	3.613	5.834
45	0.464	0.653	0.958	1.437	2.250	3.343	2.961	4.917
50	0.388	0.538	0.789	1.184	1.895	2.829	2.440	4.161
55	0.326	0.446	0.654	0.981	1.604	2.403	2.022	3.535
60	0.275	0.371	0.545	0.817	1.363	2.049	1.683	3.014
65	0.233	0.311	0.456	0.684	1.163	1.758	1.409	2.586
70	0.199	0.261	0.383	0.575	0.996	1.514	1.185	2.228
75	0.170	0.221	0.324	0.486	0.857	1.308	1.001	1.925
80	0.146	0.187	0.275	0.412	0.740	1.134	0.849	1.669
85	0.126	0.160	0.234	0.351	0.641	0.987	0.724	1.452
90	0.109	0.137	0.200	0.301	0.558	0.862	0.620	1.268
95	0.094	0.117	0.172	0.258	0.487	0.754	0.532	1.110
100	0.082	0.101	0.149	0.223	0.426	0.662	0.459	0.974
105	0.072	0.088	0.129	0.193	0.375	0.583	0.398	0.858
110	0.063	0.076	0.112	0.168	0.330	0.515	0.346	0.758
115	0.056	0.067	0.098	0.146	0.292	0.456	0.302	0.672
120	0.049	0.058	0.085	0.128	0.259	0.405	0.264	0.596
125	0.044	0.051	0.075	0.113	0.230	0.361	0.232	0.531

Part Number	NCP□□XV103	NCP□□XH153	NCP□□XW153	NCP□□XH223	NCP□□XW223	NCP□□WL223	NCP□□WB333	NCP□□WF333
Resistance	10kΩ	15kΩ	15kΩ	22kΩ	22kΩ	22kΩ	33kΩ	33kΩ
B-Constant	3900K	3380K	3950K	3380K	3950K	4485K	4050K	4250K
Temp. (°C)	Resistance (kΩ)	Resistance (kΩ)	Resistance (kΩ)	Resistance (kΩ)	Resistance (kΩ)	Resistance (kΩ)	Resistance (kΩ)	Resistance (kΩ)
-40	328.996	293.651	517.912	430.688	759.605	1073.436	1227.263	1451.049
-35	237.387	222.375	371.724	326.150	545.196	753.900	874.449	1019.238
-30	173.185	170.103	270.048	249.484	396.070	535.073	630.851	725.084
-25	127.773	131.395	198.426	192.712	291.025	383.590	460.457	522.021
-20	95.327	102.394	147.278	150.178	216.008	277.643	339.797	379.842
-15	71.746	80.501	110.439	118.068	161.977	202.813	253.363	279.371
-10	54.564	63.778	83.617	93.540	122.638	149.462	190.766	207.566
-5	41.813	50.851	63.888	74.581	93.702	111.082	144.964	155.639
0	32.330	40.836	49.221	59.893	72.191	83.233	111.087	117.814
5	25.194	33.037	38.245	48.454	56.093	62.858	85.842	89.925
10	19.785	26.891	29.936	39.441	43.907	47.831	66.861	69.204
15	15.651	22.012	23.613	32.284	34.633	36.664	52.470	53.675
20	12.468	18.122	18.756	26.578	27.509	28.304	41.471	41.937
25	10.000	15.000	15.000	22.000	22.000	22.000	33.000	33.000
30	8.072	12.471	12.074	18.291	17.709	17.214	26.430	26.143
35	6.556	10.421	9.780	15.284	14.344	13.557	21.298	20.845
40	5.356	8.750	7.969	12.833	11.688	10.744	17.266	16.723
45	4.401	7.374	6.531	10.816	9.578	8.566	14.076	13.498
50	3.635	6.240	5.382	9.152	7.894	6.871	11.538	10.954
55	3.019	5.301	4.459	7.775	6.540	5.543	9.506	8.940
60	2.521	4.520	3.713	6.630	5.446	4.497	7.870	7.334
65	2.115	3.878	3.108	5.688	4.559	3.669	6.549	6.046
70	1.781	3.340	2.613	4.899	3.832	3.009	5.475	5.011
75	1.509	2.886	2.208	4.233	3.239	2.481	4.595	4.170
80	1.284	2.502	1.873	3.669	2.748	2.056	3.874	3.487
85	1.097	2.177	1.597	3.194	2.342	1.713	3.282	2.928
90	0.941	1.901	1.367	2.788	2.004	1.434	2.789	2.469
95	0.810	1.664	1.174	2.440	1.722	1.206	2.379	2.091
100	0.701	1.460	1.013	2.141	1.486	1.019	2.038	1.777
105	0.608	1.286	0.878	1.887	1.287	0.866	1.751	1.516
110	0.530	1.136	0.763	1.667	1.119	0.739	1.509	1.298
115	0.463	1.007	0.665	1.477	0.975	0.633	1.306	1.116
120	0.406	0.894	0.582	1.311	0.854	0.545	1.134	0.962
125	0.358	0.796	0.511	1.168	0.750	0.471	0.987	0.832

Continued on the following page. ↗



## for Temperature Compensation Temperature Characteristics (Center Value)

Continued from the preceding page.

Part Number	NCP□□WL333	NCP□□WB473	NCP□□WL473	NCP□□WD683	NCP□□WF683	NCP□□WL683	NCP□□WF104	NCP□□WL104
Resistance	33kΩ	47kΩ	47kΩ	68kΩ	68kΩ	68kΩ	100kΩ	100kΩ
B-Constant	4485K	4050K	4485K	4150K	4250K	4485K	4250K*	4485K
Temp. (°C)	Resistance (kΩ)	Resistance (kΩ)	Resistance (kΩ)	Resistance (kΩ)	Resistance (kΩ)	Resistance (kΩ)	Resistance (kΩ)	Resistance (kΩ)
-40	1610.154	1747.920	2293.249	2735.359	2990.041	3317.893	4397.119	4879.254
-35	1130.850	1245.428	1610.605	1937.391	2100.247	2330.237	3088.599	3426.818
-30	802.609	898.485	1143.110	1389.345	1494.113	1653.862	2197.225	2432.149
-25	575.385	655.802	819.487	1008.014	1075.679	1185.641	1581.881	1743.590
-20	416.464	483.954	593.146	738.978	782.705	858.168	1151.037	1262.012
-15	304.219	360.850	433.281	547.456	575.674	626.875	846.579	921.875
-10	224.193	271.697	319.305	409.600	427.712	461.974	628.988	679.373
-5	166.623	206.463	237.312	309.217	320.710	343.345	471.632	504.919
0	124.850	158.214	177.816	235.606	242.768	257.266	357.012	378.333
5	94.287	122.259	134.287	180.980	185.300	194.287	272.500	285.717
10	71.747	95.227	102.184	140.139	142.603	147.841	209.710	217.414
15	54.996	74.730	78.327	109.344	110.602	113.325	162.651	166.654
20	42.455	59.065	60.467	85.929	86.415	87.484	127.080	128.653
25	33.000	47.000	47.000	68.000	68.000	68.000	100.000	100.000
30	25.822	37.643	36.776	54.167	53.871	53.208	79.222	78.247
35	20.335	30.334	28.962	43.421	42.954	41.903	63.167	61.622
40	16.115	24.591	22.952	35.016	34.460	33.208	50.677	48.835
45	12.849	20.048	18.301	28.406	27.814	26.477	40.904	38.937
50	10.306	16.433	14.679	23.166	22.572	21.237	33.195	31.231
55	8.314	13.539	11.842	18.997	18.422	17.133	27.091	25.195
60	6.746	11.209	9.607	15.657	15.113	13.900	22.224	20.441
65	5.503	9.328	7.837	12.967	12.459	11.339	18.323	16.675
70	4.513	7.798	6.428	10.794	10.325	9.300	15.184	13.677
75	3.721	6.544	5.300	9.021	8.592	7.668	12.635	11.277
80	3.084	5.518	4.393	7.575	7.185	6.356	10.566	9.346
85	2.569	4.674	3.659	6.387	6.033	5.294	8.873	7.785
90	2.151	3.972	3.063	5.407	5.087	4.432	7.481	6.517
95	1.809	3.388	2.577	4.598	4.309	3.728	6.337	5.482
100	1.529	2.902	2.178	3.922	3.661	3.151	5.384	4.634
105	1.299	2.494	1.849	3.359	3.124	2.676	4.594	3.935
110	1.108	2.150	1.578	2.887	2.675	2.283	3.934	3.357
115	0.949	1.860	1.352	2.489	2.299	1.956	3.380	2.877
120	0.817	1.615	1.164	2.155	1.983	1.684	2.916	2.476
125	0.707	1.406	1.006	1.870	1.715	1.456	2.522	2.141

Part Number	NCP□□WL154	NCP□□WM154	NCP□□WL224	NCP□□WM224	NCP□□WM474
Resistance	150kΩ	150kΩ	220kΩ	220kΩ	470kΩ
B-Constant	4485K	4500K	4485K	4500K	4500K
Temp. (°C)	Resistance (kΩ)	Resistance (kΩ)	Resistance (kΩ)	Resistance (kΩ)	Resistance (kΩ)
-40	7318.881	7899.466	10734.358	11585.884	24751.661
-35	5140.228	5466.118	7539.001	8016.973	17127.169
-30	3648.224	3834.499	5350.729	5623.931	12014.762
-25	2615.385	2720.523	3835.898	3990.100	8524.305
-20	1893.018	1951.216	2776.427	2861.784	6113.811
-15	1382.813	1415.565	2028.126	2076.162	4435.437
-10	1019.059	1036.984	1494.620	1520.909	3249.216
-5	757.379	767.079	1110.822	1125.049	2403.515
0	567.499	572.667	832.332	839.912	1794.358
5	428.575	431.264	628.577	632.521	1351.294
10	326.121	327.405	478.310	480.194	1025.870
15	249.981	250.538	366.639	367.455	785.018
20	192.979	193.166	283.036	283.310	605.252
25	150.000	150.000	220.000	220.000	470.000
30	117.370	117.281	172.143	172.012	367.480
35	92.433	92.293	135.569	135.364	289.186
40	73.252	73.090	107.436	107.198	229.014
45	58.406	58.240	85.662	85.419	182.485
50	46.846	46.665	68.708	68.441	146.215
55	37.793	37.605	55.429	55.153	117.828
60	30.661	30.453	44.970	44.665	95.420
65	25.013	24.804	36.686	36.379	77.718
70	20.516	20.293	30.090	29.763	63.584
75	16.916	16.679	24.810	24.462	52.260
80	14.019	13.776	20.562	20.205	43.166
85	11.678	11.428	17.128	16.761	35.808
90	9.776	9.520	14.338	13.962	29.828
95	8.223	7.966	12.061	11.684	24.961
100	6.951	6.688	10.194	9.809	20.955
105	5.902	5.639	8.657	8.270	17.668
110	5.035	4.772	7.385	6.998	14.951
115	4.315	4.052	6.329	5.942	12.695
120	3.714	3.454	5.448	5.067	10.824
125	3.211	2.955	4.710	4.334	9.259

\* B-Constant of NCP18WF104F type is 4200K. Please contact us for the detail data.

## Chip Type ⚠Caution/Notice

### ■ ⚠Caution (Storage and Operating Conditions)

This product is designed for application in an ordinary environment (normal room temperature, humidity and atmospheric pressure).

Do not use under the following conditions because all these factors can deteriorate the product characteristics or cause failures and burn-out.

1. Corrosive gas or deoxidizing gas  
(Chlorine gas, Hydrogen sulfide gas, Ammonia gas, Sulfuric acid gas, Nitric oxide gas, etc.)
2. Volatile or flammable gas
3. Dusty conditions
4. Under high or low pressure
5. Wet or humid locations
6. Places with salt water, oils, chemical liquids or organic solvents
7. Strong vibrations
8. Other places where similar hazardous conditions exist

### ■ ⚠Caution (Others)

Be sure to provide an appropriate fail-safe function on your product to prevent secondary damages that may be caused by the abnormal function or the failure of our product.

### ■ Notice (Storage and Operating Conditions)

To keep solderability of product from declining, the following storage condition is recommended.

1. Storage condition:  
Temperature -10 to +40 degree C  
Humidity less than 75%RH (not dewing condition)
2. Storage term:  
Use this product within 6 months after delivery by first-in and first-out stocking system.
3. Handling after unpacking:  
After unpacking, reseal product promptly or store it in a sealed container with a drying agent.
4. Storage place:  
Do not store this product in corrosive gas (sulfuric acid gas, chlorine gas, etc.) or in direct sunlight.

### ■ Notice (Rating)

Use this product within the specified temperature range.

Higher temperature may cause deterioration of the characteristics or the material quality of this product.

### ■ Notice (Handling)

The ceramic of this product is fragile, and care must be taken not to load a excessive press-force or not to give a shock at handling.

Such forces may cause cracking or chipping.

# Chip Type Caution/Notice

## ■ Notice (Soldering and Mounting)

### 1. Mounting Position

Choose a mounting position that minimizes the stress imposed on the chip during flexing or bending of the board.

**[Component Direction]**

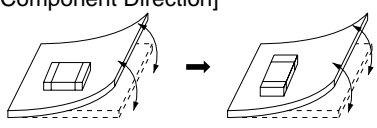

Locate this product horizontal to the direction in which stress acts.

**[Mounting Close to Board Separation Line]**

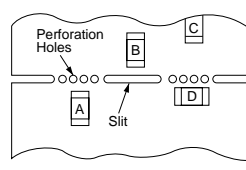

Keep this product on the PC Board away from the Separation Line.  
Worst ← A-C-B-D → Better

### 2. Reflow Soldering Conditions (NCP03/NCP15 Series)

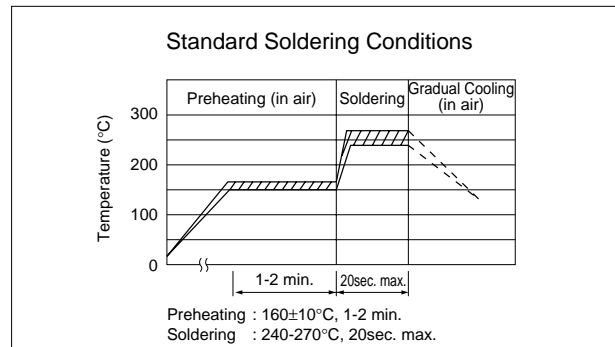
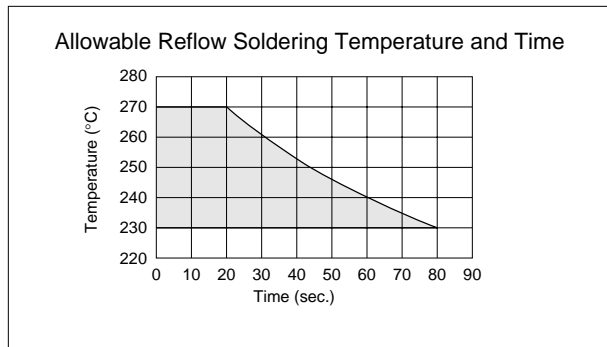

### (NCP18/NCP21 Series)

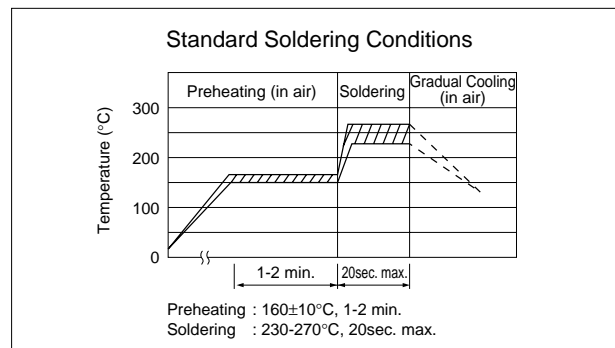
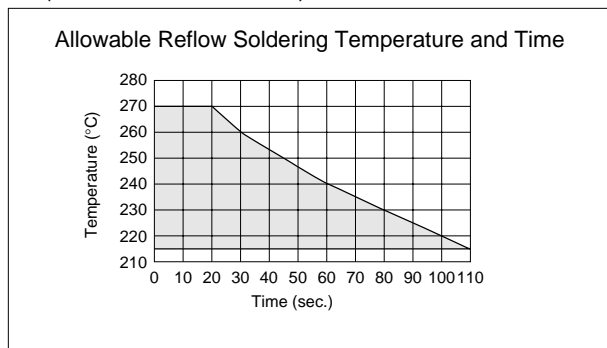

### 3. Flow Soldering Conditions (NCP18/NCP21 Series)

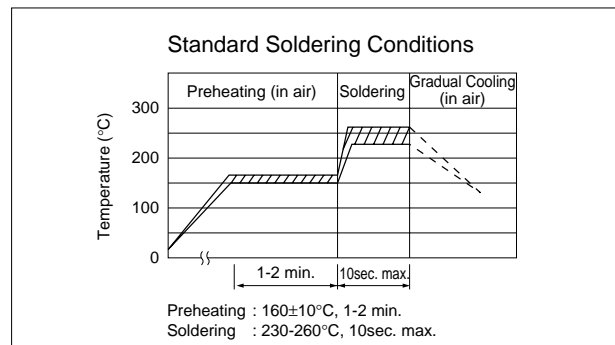
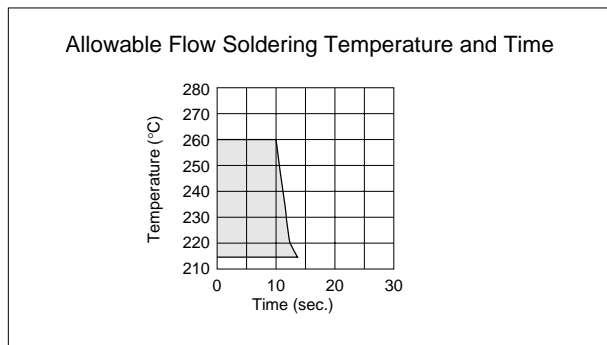

Continued on the following page. 

## Chip Type ⚠ Caution/Notice

☒ Continued from the preceding page.

### 4. Solder and Flux

#### (1) Solder and Paste

##### (a) Reflow Soldering : NCP03/15/18/21 Series

Use RA/RMA type or equivalent type of solder paste. For your reference, we are using the solder paste below for any internal tests of this product.

- RMA9086 90-4-M20 (Sn:Pb=63wt%:37wt%)  
(Manufactured by Alpha Metals Japan Ltd.)
- M705-221BM5-42-11 (Sn:Ag:Cu=96.5wt%:3.0wt%:0.5wt%)  
(Manufactured by Senju Metal Industry Co., Ltd.)

##### (b) Flow Soldering : NCP18/21 Series

We are using the solder paste below. For any internal tests of this product.

- Sn : Pb=63wt%:37wt%
- Sn : Ag : Cu=96.5wt% : 3.0wt% : 0.5wt%

##### (2) Flux

Use Rosin-based flux.

Do not use strong acidic flux (with halide content exceeding 0.2wt%)

### 5. Cleaning Conditions

For removing the flux after soldering, observe the following points in order to avoid deterioration of the characteristics or any change of the external electrodes' quality.

	NCP03/15	NCP18/21
Solvent	Isopropyl Alcohol	Isopropyl Alcohol
Dipping Cleaning	Less than 5min. at room temp. or less than 2min. at 40°C max.	Less than 5min. at room temp. or less than 2min. at 40°C max.
Ultrasonic Cleaning	Less than 5min. 20W/ℓ Frequency of 28 to 40kHz.	Less than 1min. 20W/ℓ Frequency of several 10kHz to 100kHz.

### 6. Drying

After cleaning, promptly dry this product.

### 7. Printing Conditions of Solder Paste

- The amount of solder is critical. Standard height of fillet is shown in the table below.
- Too much soldering may cause mechanical stress, resulting in cracking, mechanical and/or electronic damage.

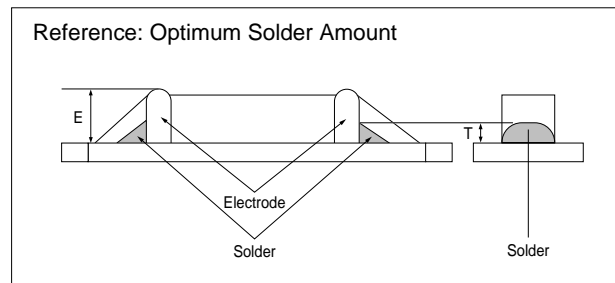

Part Number	The solder paste thickness	T
NCP03	100μm	$1/3E \leq T \leq E$
NCP15	100μm	$1/3E \leq T \leq E$
NCP18/NCP21	150μm	$0.2\text{mm} \leq T \leq E$

### 8. Adhesive Application and Curing

- Thin or insufficient adhesive may result in loose component contact with land during flow soldering.
- Low viscosity adhesive causes chips to slip after mounting.

# Chip Type Package

## Minimum Quantity Guide

Part Number	Quantity (pcs.)	
	Paper Tape	Plastic Tape
NCP03	15000	-
NCP15	10000	
NCP18	4000	
NCP21	-	4000

## Tape Carrier Packaging

### 1. Dimensions of Reel

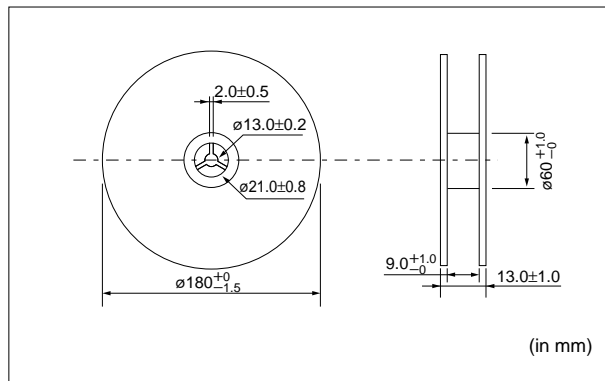

### 2. Taping Method

- (1) A tape in a reel contains Leader unit and Trailer unit where products are not packed. (Please refer to the figure right.)
- (2) The top and base tapes or, plastic and cover tape are not stuck at the first five pitches minimum.
- (3) A label should be attached on the reel. (MURATA's part number, inspection number and quantity should be marked on the label.)
- (4) Taping reels are packed in a package.

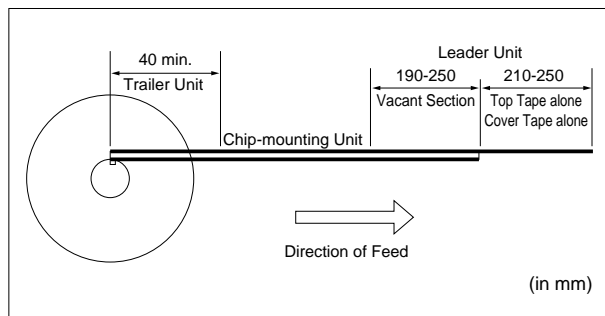

Continued on the following page.

## Chip Type Package

Continued from the preceding page.

### 3. Paper Tape (NCP03/15/18 Series)

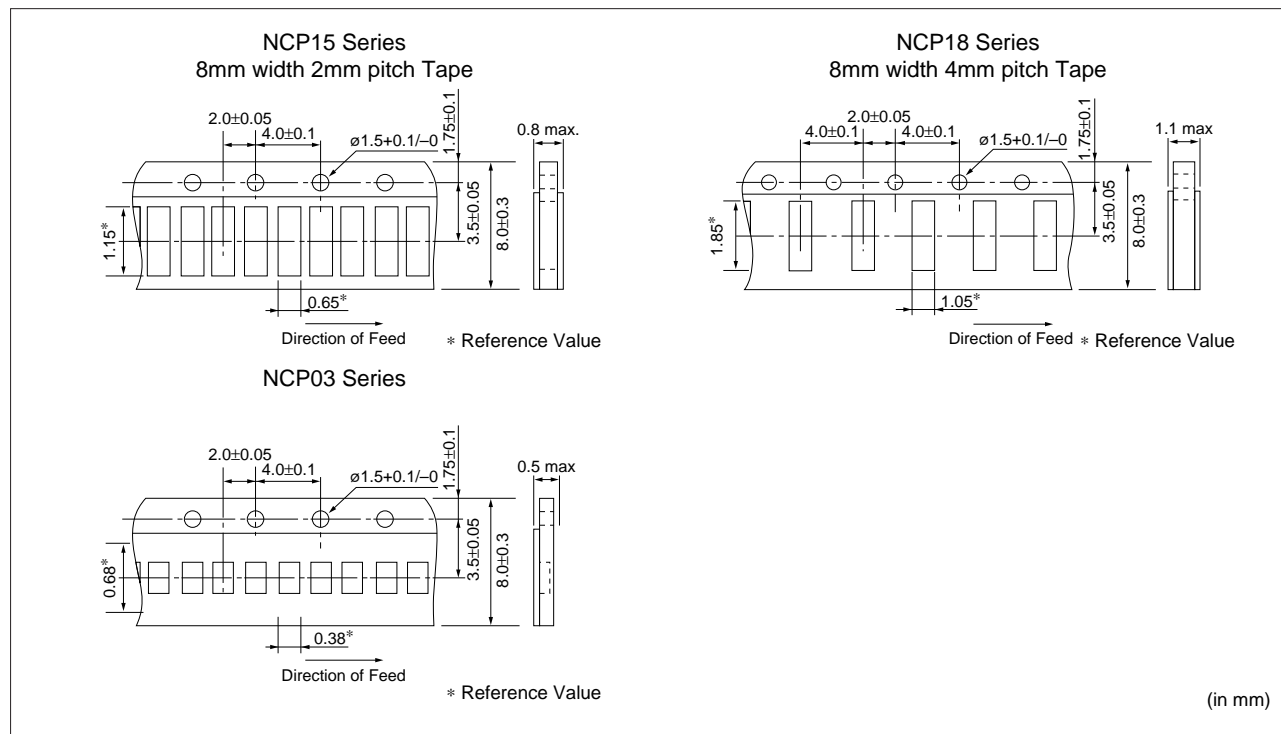

#### (1) Other Conditions

##### (a) Packaging

Products are packaged in the cavity of the base tape and sealed by top tape and bottom tape.

##### (b) Tape

Top tape and bottom tape have no joints and products are packaged and sealed in the cavity of the base tape, continuously.

#### (2) Peeling force of top tape

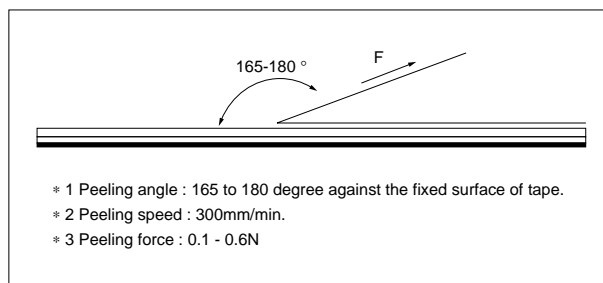

#### (3) Pull Strength

Pull strength of top tape is specified at 10N minimum.

Pull strength of bottom tape are specified 5N minimum.

Continued on the following page. ↗

## Chip Type Package

Continued from the preceding page.

### 4. Plastic Tape (NCP21 Series)

#### (1) Other Conditions

##### (a) Packaging

Products are packaged in the each embossed cavity of plastic tape and sealed by cover tape.

##### (b) Tape

Cover tape has no joints.

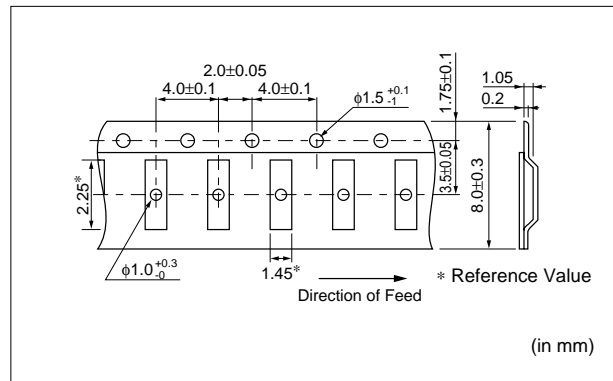

#### (2) Peeling force of cover tape

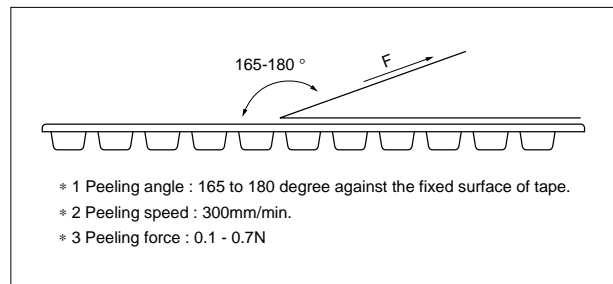

#### (3) Tape Strength

Pull strength of plastic tape and cover tape shall be specified 10N minimum.

# NTC Thermistors



## for Temperature Sensor Lead Type

This product is a sensor type NTC Thermistor to be useful in the normal temperature range developed by the unique ceramic technology and the automatic assembly.

### ■ Features

1. High-accuracy of +/-1%  
+/-1% of resistance and B-Constant tolerance is realized due to uniform thickness by the precise sheet forming method.
2. Quick response  
This product provides faster response time due to its smaller size.
3. Taping type is available (Standard type).
4. Strong lead strength  
Original lead-wiring technique assures reliable connection. It can be formed and bent flexibly according to the mounting conditions.

### ■ Applications

1. Rechargeable batteries
2. Battery charging circuits
3. Head of printers
4. DC fan motors
5. Home appliance equipments

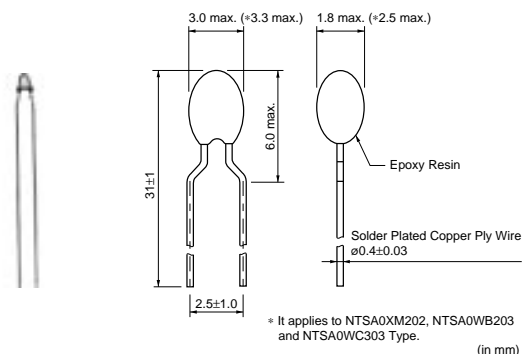

5

Part Number	Resistance (25°C) (k ohm)	B-Constant (25-50°C) (K)	Permissible Operating Current (25°C) (mA)	Rated Electric Power (25°C) (mW)	Typical Dissipation Constant (25°C) (mW/°C)	Thermal Time Constant (25°C)(s)	Operating Temperature Range (°C)
NNTSA0XM202□E1B0	2.0	3500 ±1%	1.05	21	2.1	7	-40 to 125
NNTSA0XR502□E1B0	5.0	3700 ±1%	0.68	21	2.1	7	-40 to 125
NNTSA0XH103□E1B0	10	3380 ±1%	0.38	15	1.5	7	-40 to 125
NNTSA0XV103□E1B0	10	3900 ±1%	0.46	21	2.1	7	-40 to 125
NNTSA0WB203□E1B0	20	4050 ±1%	0.31	21	2.1	7	-40 to 125
NNTSA0WC303□E1B0	30	4100 ±1%	0.26	21	2.1	7	-40 to 125
NNTSA0WD503□E1B0	50	4150 ±1%	0.20	21	2.1	7	-40 to 125
NNTSA0WF104□E1B0	100	4250 ±1%	0.14	21	2.1	7	-40 to 125

A blank column is filled with resistance tolerance codes. (F: ±1%, E: ±3%)  
Taping type of part numbers with "N6A0" is available. (Lead spacing=5mm)

### ■ Temperature Tolerance-Temperature Characteristics

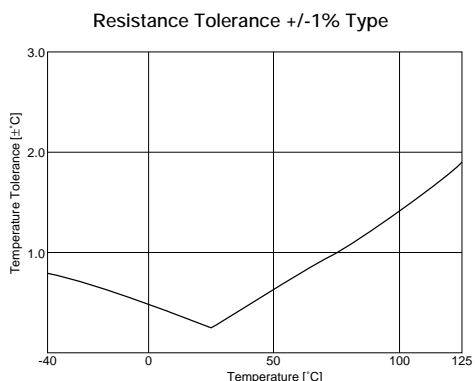



# NTC Thermistors



## for Temperature Sensor Lead Insulation Type

This product is a sensor type NTC Thermistor to be useful in the normal temperature range developed by the unique ceramic technology and the automatic assembly.

### ■ Features

1. Electric insulation on lead wire
2. Excellent bending resistance due to suitable hardness of surface coating
3. Easy handling due to most suitable hardness of surface of coating
4. High-accuracy of  $\pm 1\%$   
 $\pm 1\%$  of resistance and B-Constant tolerance are realized due to uniform thickness by the precise sheet forming method.

### ■ Applications

1. Rechargeable batteries
2. Battery charging circuits
3. Head of printers
4. DC fan motors
5. Home appliance equipments

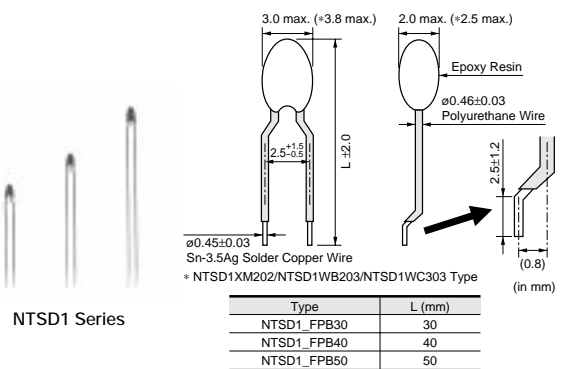
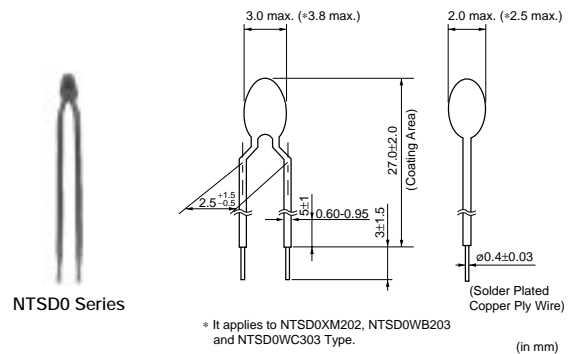

6

### NTSD0 Series

Part Number	Resistance (25°C) (k ohm)	B-Constant (25-50°C) (K)	Permissible Operating Current (25°C) (mA)	Rated Electric Power (25°C) (mW)	Typical Dissipation Constant (25°C) (mW/°C)	Thermal Time Constant (25°C)(s)	Operating Temperature Range (°C)
NTSD0XM202□E1B0	2.0	3500 ±1%	1.05	21	2.1	7	-40 to 125
NTSD0XR502□E1B0	5.0	3700 ±1%	0.68	21	2.1	7	-40 to 125
NTSD0XH103□E1B0	10	3380 ±1%	0.38	15	1.5	7	-40 to 125
NTSD0XV103□E1B0	10	3900 ±1%	0.46	21	2.1	7	-40 to 125
NTSD0WB203□E1B0	20	4050 ±1%	0.31	21	2.1	7	-40 to 125
NTSD0WC303□E1B0	30	4100 ±1%	0.26	21	2.1	7	-40 to 125
NTSD0WD503□E1B0	50	4150 ±1%	0.20	21	2.1	7	-40 to 125
NTSD0WF104□E1B0	100	4250 ±1%	0.14	21	2.1	7	-40 to 125

A blank column is filled with resistance tolerance codes. (F:  $\pm 1\%$ , E:  $\pm 3\%$ )

### NTSD1 Series

Part Number	Resistance (25°C) (k ohm)	B-Constant (25-50°C) (K)	Permissible Operating Current (25°C) (mA)	Rated Electric Power (25°C) (mW)	Typical Dissipation Constant (25°C) (mW/°C)	Thermal Time Constant (25°C)(s)	Operating Temperature Range (°C)
NTSD1XM202FPB□□	2.0 ±1%	3500 ±1%	1.05	21	2.1	7	-40 to 125
NTSD1XR502FPB□□	5.0 ±1%	3700 ±1%	0.68	21	2.1	7	-40 to 125
NTSD1XH103FPB□□	10 ±1%	3380 ±1%	0.38	15	1.5	7	-40 to 125
NTSD1XV103FPB□□	10 ±1%	3900 ±1%	0.46	21	2.1	7	-40 to 125
NTSD1WB203FPB□□	20 ±1%	4050 ±1%	0.31	21	2.1	7	-40 to 125
NTSD1WC303FPB□□	30 ±1%	4100 ±1%	0.26	21	2.1	7	-40 to 125
NTSD1WD503FPB□□	50 ±1%	4150 ±1%	0.20	21	2.1	7	-40 to 125
NTSD1WF104FPB□□	100 ±1%	4250 ±1%	0.14	21	2.1	7	-40 to 125

A blank column is filled with Total-length codes. (30, 40, 50)



## Temperature Tolerance-Temperature Characteristics

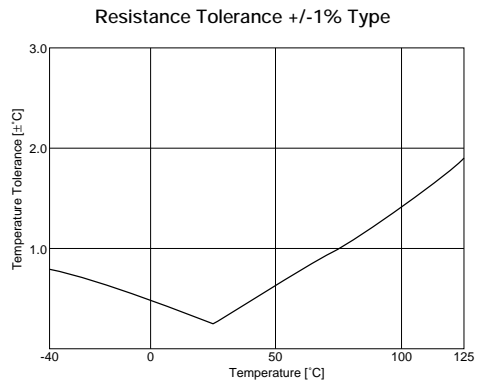

## for Temperature Sensor Temperature Characteristics (Center Value)

Part Number	NTS□□XM202	NTS□□XR502	NTS□□XH103	NTS□□XV103	NTS□□WB203	NTS□□WC303	NTS□□WD503	NTS□□WF104
Resistance	2.0kΩ	5.0kΩ	10kΩ	10kΩ	20kΩ	30kΩ	50kΩ	100kΩ
B-Constant	3500K	3700K	3380K	3900K	4050K	4100K	4150K	4250K
Temp. (°C)	Resistance (kΩ)	Resistance (kΩ)	Resistance (kΩ)	Resistance (kΩ)	Resistance (kΩ)	Resistance (kΩ)	Resistance (kΩ)	Resistance (kΩ)
-40	44.657	123.484	195.652	347.808	733.007	1149.500	1948.575	4256.752
-35	33.505	92.295	148.171	248.591	524.831	819.651	1387.289	3005.888
-30	25.388	69.614	113.347	179.973	380.184	591.391	999.456	2148.514
-25	19.402	52.860	87.559	131.832	277.845	430.529	728.895	1555.020
-20	14.961	40.480	68.237	97.679	205.260	316.870	537.039	1137.312
-15	11.644	31.275	53.650	73.119	153.642	236.337	399.167	839.314
-10	9.133	24.339	42.506	55.301	116.016	177.842	299.469	625.338
-5	7.198	19.154	33.892	42.257	88.125	134.630	226.186	469.127
0	5.716	15.148	27.219	32.582	67.522	102.816	172.393	355.224
5	4.571	11.964	22.021	25.324	52.168	79.183	132.857	272.045
10	3.682	9.520	17.926	19.847	40.617	61.460	103.089	209.803
15	2.987	7.624	14.674	15.679	31.847	48.045	80.430	162.713
20	2.437	6.160	12.081	12.478	25.151	37.834	63.201	127.117
25	2.000	5.000	10.000	10.000	20.000	30.000	50.000	100.000
30	1.651	4.082	8.315	8.068	16.014	23.955	39.825	79.215
35	1.371	3.354	6.948	6.552	12.902	19.249	31.918	63.150
40	1.143	2.773	5.834	5.353	10.457	15.560	25.733	50.649
45	0.958	2.299	4.917	4.399	8.527	12.657	20.877	40.885
50	0.807	1.914	4.161	3.635	6.993	10.354	17.034	33.195
55	0.683	1.607	3.535	3.020	5.771	8.525	13.929	27.014
60	0.582	1.356	3.014	2.521	4.789	7.058	11.439	22.079
65	0.497	1.149	2.586	2.115	3.992	5.869	9.485	18.226
70	0.426	0.978	2.228	1.783	3.343	4.905	7.906	15.124
75	0.367	0.834	1.925	1.510	2.809	4.113	6.614	2.598
80	0.318	0.714	1.669	1.284	2.371	3.463	5.558	10.542
85	0.276	0.612	1.452	1.096	2.020	2.945	4.686	8.852
90	0.240	0.527	1.268	0.939	1.729	2.516	3.967	7.463
95	0.210	0.456	1.110	0.808	1.476	2.143	3.373	6.321
100	0.183	0.396	0.974	0.698	1.264	1.832	2.878	5.374
105	0.161	0.345	0.858	0.605	1.085	1.571	2.465	4.585
110	0.142	0.302	0.758	0.527	0.935	1.350	2.118	3.925
115	0.125	0.264	0.671	0.460	0.812	1.171	1.828	3.376
120	0.111	0.232	0.596	0.403	0.708	1.019	1.583	2.913
125	0.099	0.205	0.531	0.354	0.617	0.886	1.374	2.520

## for Temperature Sensor Lead Type/Lead Insulation Type ⚠Caution/Notice

### ■ ⚠Caution (Storage and Operating Conditions)

This product is designed for application in an ordinary environment (normal room temperature, humidity and atmospheric pressure).

Do not use under the following conditions because all these factors can deteriorate the product characteristics or cause failures and burn-out.

1. Corrosive gas or deoxidizing gas  
(Chlorine gas, Hydrogen sulfide gas, Ammonia gas, Sulfuric acid gas, Nitric oxide gas, etc.)
2. Volatile or flammable gas
3. Dusty conditions
4. Under high or low pressure
5. Wet or humid locations
6. Places with salt water, oils, chemical liquids or organic solvents
7. Strong vibrations
8. Other places where similar hazardous conditions exist

### ■ ⚠Caution (Others)

Be sure to provide an appropriate fail-safe function on your product to prevent secondary damages that may be caused by the abnormal function or the failure of our product.

### ■ Notice (Storage and Operating Conditions)

To keep solderability of product from declining, the following storage condition is recommended.

1. Storage condition:  
Temperature -10 to +40 degree C  
Humidity less than 75%RH (not dewing condition)
2. Storage term:  
Use this product within 6 months after delivery by first-in and first-out stocking system.
3. Handling after unpacking:  
After unpacking, reseal product promptly or store it in a sealed container with a drying agent.
4. Storage place:  
Do not store this product in corrosive gas (sulfuric acid gas, chlorine gas, etc.) or in direct sunlight.

### ■ Notice (Rating)

Use this product within the specified temperature range.

Higher temperature may cause deterioration of the characteristics or the material quality of this product.

### ■ Notice (Soldering and Mounting)

1. Be sure that the preheat-up does not melt the soldering of this product. Excessive heat may cause failure to open, short or insulation break down.
2. Do not touch the body with soldering iron.  
The soldering point should be min. 5mm away from the root of lead wire.

### ■ Notice (Handling)

1. The ceramic element of this product is fragile, and care must be taken not to load an excessive press-force or not to give a shock at handling. Such forces may cause cracking or chipping.
2. Do not apply an excessive force to the lead. Otherwise, it may cause junction between lead and element to break or crack. Holding element by side lead wire is recommended when lead wire is bent or cut.

## for Temperature Sensor Lead Type/Lead Insulation Type NTSA/NTSD Series Package

### Minimum Quantity

Part Number	Minimum Quantity (pcs.)	
	Ammo Pack	Bulk
NTSA	3000	100
NTSD	-	100

### Taping Dimensions (NTSA Series)

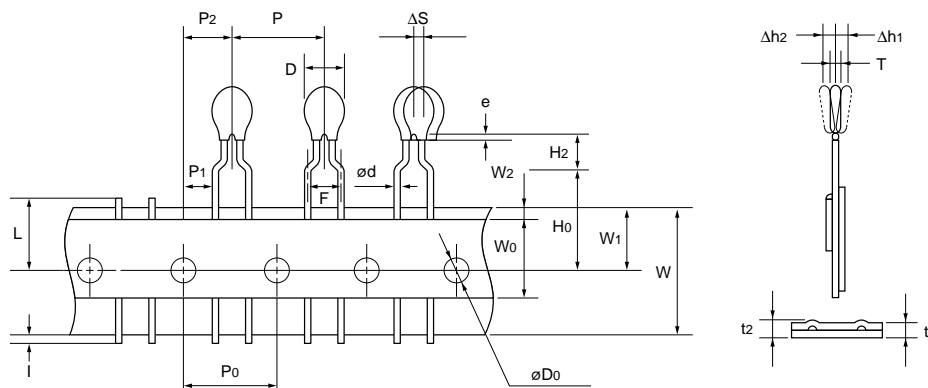

Item	Code	Dimensions (mm)
Pitch of Component	P	12.7
Pitch of Sprocket Hole	P <sub>0</sub>	12.7±0.3
Lead Spacing	F	5.0+0.8/-0.2
Lead Length from Hole Center to Component Center	P <sub>2</sub>	6.35±1.3
Lead Length from Hole Center to Lead	P <sub>1</sub>	3.85±0.8
Body Diameter	D	3.5 max.
Deviation along Tape, Left or Right	ΔS	0±2.0
Carrier Tape Width	W	18.0±0.5
Position of Sprocket Hole	W <sub>1</sub>	9.0±0.5
Lead Distance between Reference and Bottom Planes	H <sub>0</sub>	16.0±1.0
Height of Component	H <sub>2</sub>	4.0 max.
Overflow of Lead	l	+0.5 to -1.0
Diameter of Sprocket Hole	D <sub>0</sub>	4.0±0.1
Lead Diameter	d	0.50±0.03
Total Tape Thickness	t <sub>1</sub>	0.6±0.3
Total Thickness, Tape and Lead Wire	t <sub>2</sub>	1.6 max.
Deviation across Tape	Δh <sub>1</sub> , Δh <sub>2</sub>	1.0 max.
Portion to Cut in Case of Defect	L	11.0+0/-2.0
Hole Down Tape Width	W <sub>0</sub>	11.0 min.
Hole Down Tape Position	W <sub>2</sub>	1.5±1.5
Coating Extension on Lead	e	Up to the crimp point
Thickness	T	2.6 max.

(in mm)

# NTC Thermistors



## for Inrush Current Suppression Lead Type

This product effectively suppresses surge currents which are generated when switching power regulators are turned on.

### ■ Features

1. Lead is not contained in the ceramic element, the terminations, the solder for inner connection and the coating resin.
2. Most suitable for power supplies of less than 100W
3. Excellent recovery characteristics due to resin coating with excellent heat characteristics
4. Highly reliable

### ■ Applications

1. Switching power supplies
2. CRT monitors
3. Color televisions
4. VCR-Power supplies
5. Other power circuits



NTPAN/NTPAJ Series

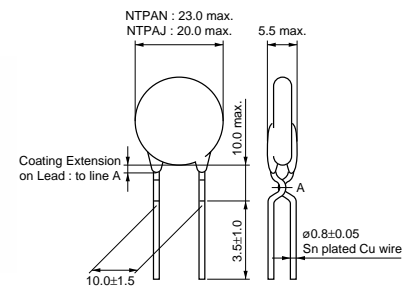

(in mm)



NTPAD/NTPAA Series

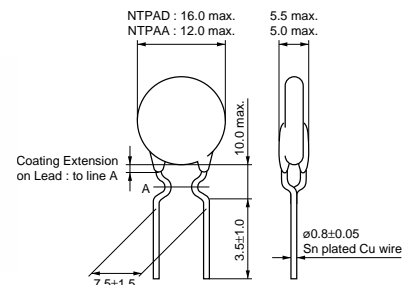

(in mm)



NTPA7/NTPA9 Series

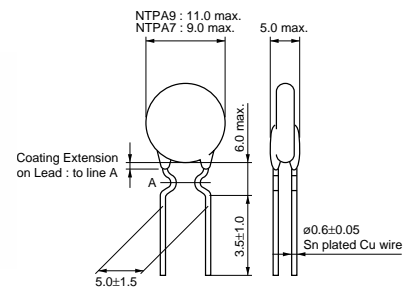

(in mm)

Part Number	Resistance (25°C) (ohm)	Permissible Max. Current (25°C) (A)	Permissible Max. Current (55°C) (A)	Thermal Time Constant (25°C)(s)	Thermal Dissipation Constant (mW/°C)	Permissible Electrolytic Capacitor (μF)
NTPAN3R0LDKB0	3.0 ±15%	5.4	4.7	135	26.8	8600 at 100V
NTPAN4R0LDKB0	4.0 ±15%	4.7	4.1	130	26.8	8600 at 100V
NTPAN6R0LDKB0	6.0 ±15%	3.9	3.4	130	26.8	8600 at 100V
NTPAJ4R0LDKB0	4.0 ±15%	4.0	3.5	125	21.8	5000 at 100V
NTPAJ6R0LDKB0	6.0 ±15%	3.4	2.9	125	21.8	5000 at 100V
NTPAJ8R0LDKB0	8.0 ±15%	3.0	2.6	130	21.8	5000 at 100V
NTPAJ100LDKB0	10.0 ±15%	2.6	2.2	130	21.8	5000 at 100V
NTPAD3R9LDNB0	3.9 ±15%	3.3	2.9	65	18.2	2700 at 100V
NTPAD5R1LDNB0	5.1 ±15%	3.0	2.6	85	18.8	2700 at 100V
NTPAD8R0LDNB0	8.0 ±15%	2.7	2.3	65	18.7	2700 at 100V
NTPAD160LDNB0	16.0 ±15%	2.0	1.7	100	19.1	2700 at 100V
NTPAA2R2LDNB0	2.2 ±15%	3.7	3.2	70	13.5	1400 at 100V

Continued on the following page.

Continued from the preceding page.

Part Number	Resistance (25°C) (ohm)	Permissible Max. Current (25°C) (A)	Permissible Max. Current (55°C) (A)	Thermal Time Constant (25°C)(s)	Thermal Dissipation Constant (mW/°C)	Permissible Electrolytic Capacitor (μF)
<b>NTPAA3R9LDNB0</b>	3.9 ±15%	2.7	2.3	70	13.5	1400 at 100V
<b>NTPAA5R1LDNB0</b>	5.1 ±15%	2.5	2.2	70	13.5	1400 at 100V
<b>NTPAA8R2LDNB0</b>	8.2 ±15%	2.0	1.7	70	13.5	1400 at 100V
<b>NTPAA100LDNB0</b>	10.0 ±15%	1.7	1.5	70	13.5	1400 at 100V
<b>NTPA9160LBMB0</b>	16.0 ±15%	1.4	1.2	65	11.6	800 at 100V
<b>NTPA74R0LBMB0</b>	4.0 ±15%	2.3	2.0	40	9.4	700 at 100V
<b>NTPA78R0LBMB0</b>	8.0 ±15%	1.7	1.5	40	9.5	570 at 100V
<b>NTPA7160LBMB0</b>	16.0 ±15%	1.2	1.0	40	9.9	400 at 100V
<b>NTPA7220LBMB0</b>	22.0 ±15%	1.0	0.88	40	9.1	400 at 100V

NTPAD/NTPAA/NTPA7 series are also available on tape.

### Application Circuit

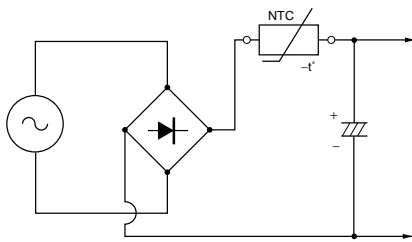

### Determination of Allowable Current

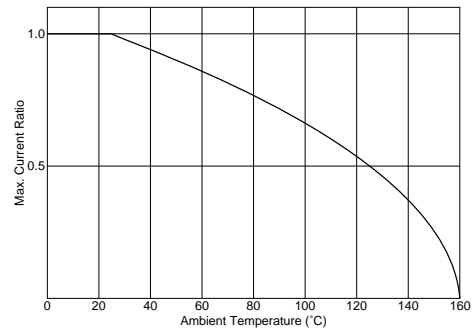

## Current-R Ratio (RT/R25) / Current-Temperature Characteristics (Typical)

### ■ NTPAN3R0L Type

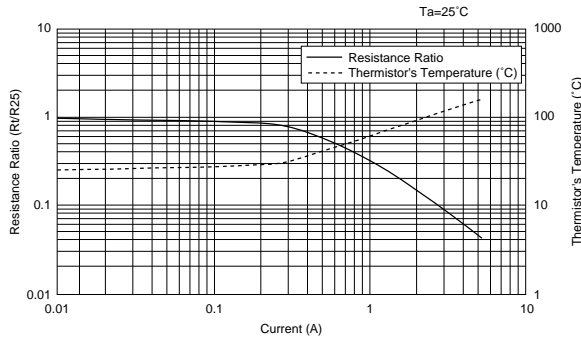

### ■ NTPAN4R0L Type

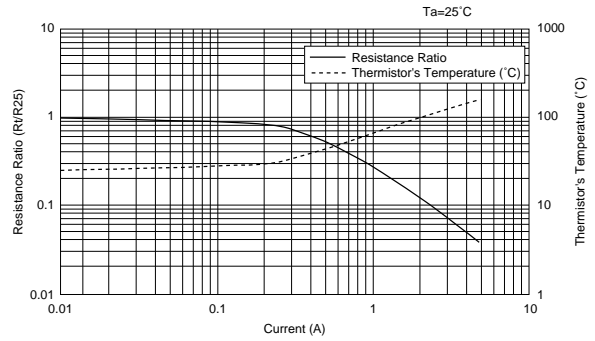

### ■ NTPAN6R0L Type

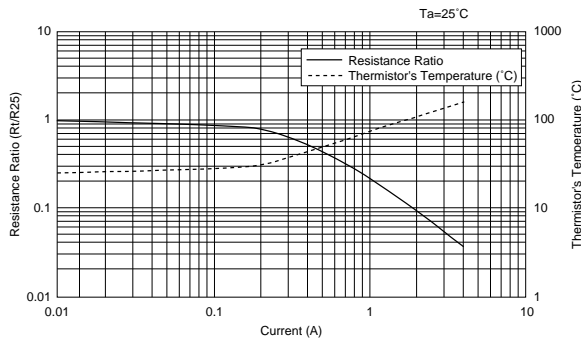

### ■ NTPAJ4R0L Type

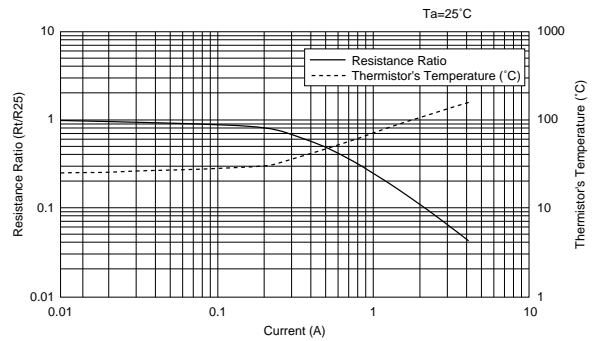

### ■ NTPAJ6R0L Type

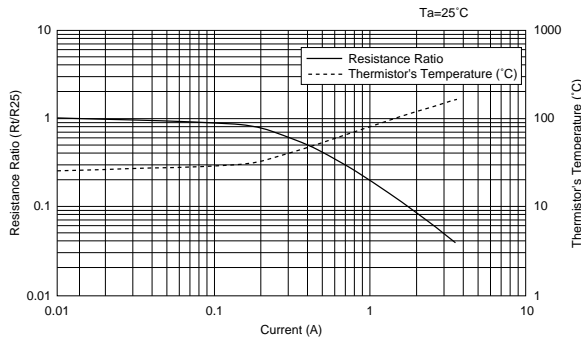

### ■ NTPAJ8R0L Type

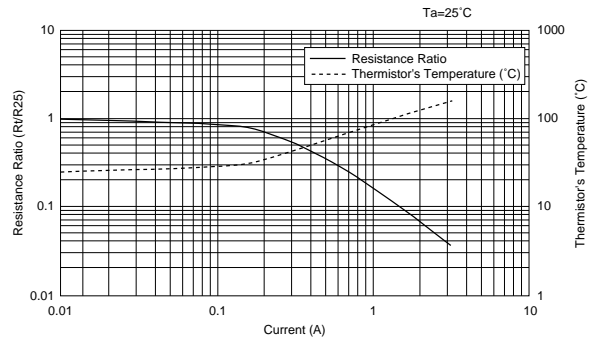

7

Continued on the following page. ↗



# Current-R Ratio (RT/R25) / Current-Temperature Characteristics (Typical)

Continued from the preceding page.

## ■ NTPAJ100L Type

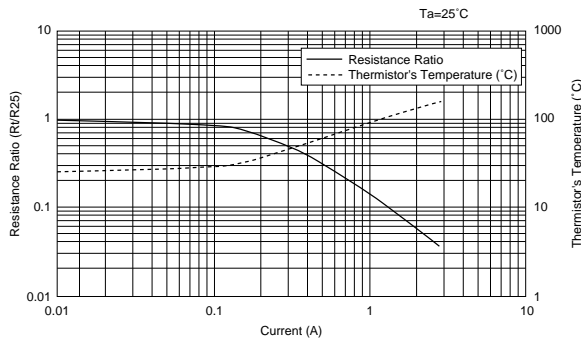

## ■ NTPAD3R9L Type

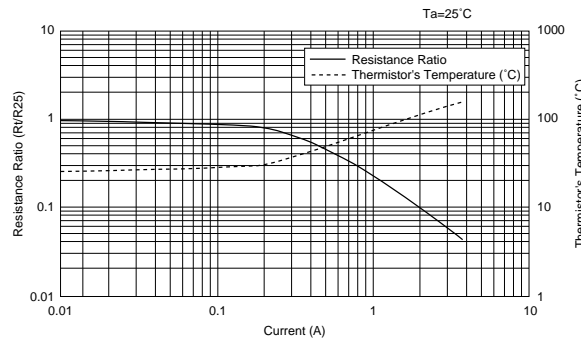

## ■ NTPAD5R1L Type

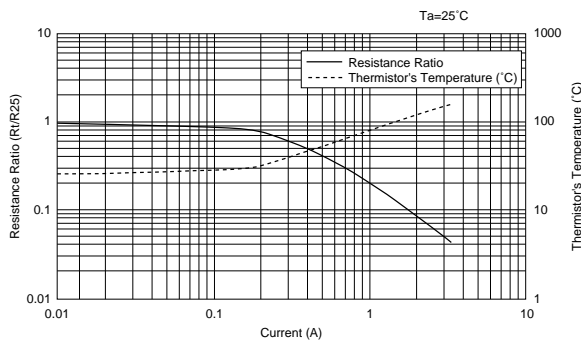

## ■ NTPAD8R0L Type

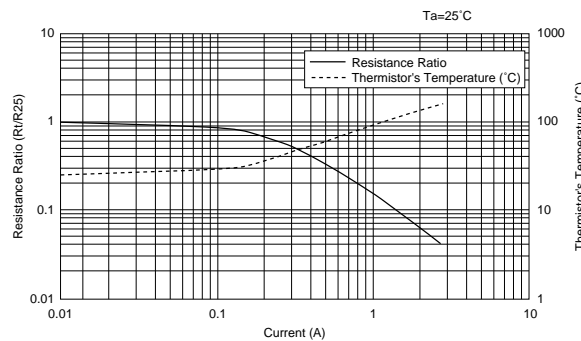

## ■ NTPAD160L Type

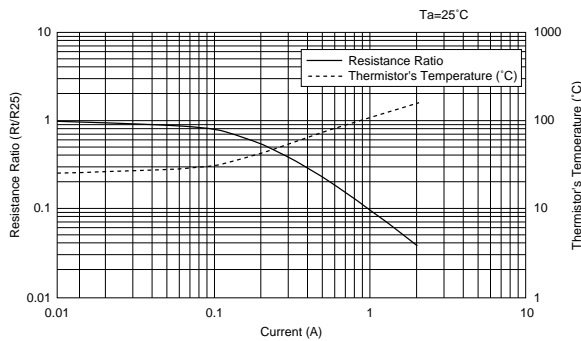

## ■ NTPAA2R2L Type

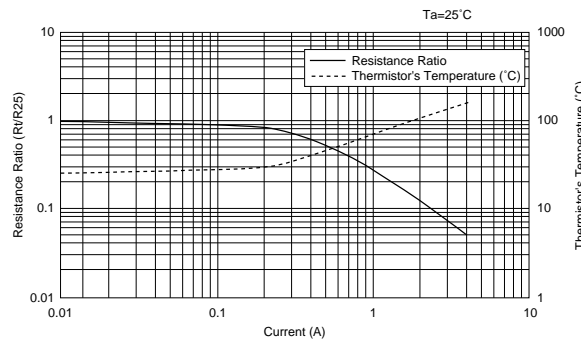

7

Continued on the following page. ↗

## Current-R Ratio (RT/R25) / Current-Temperature Characteristics (Typical)

Continued from the preceding page.

### ■ NTPAA3R9L Type

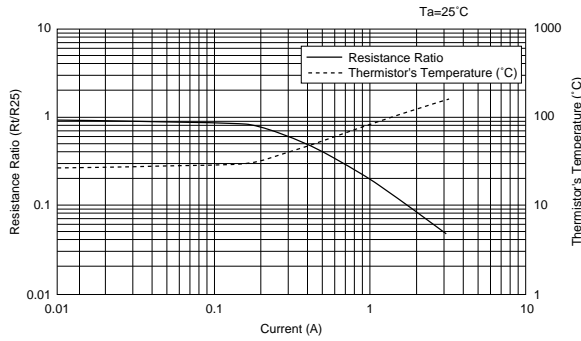

### ■ NTPAA5R1L Type

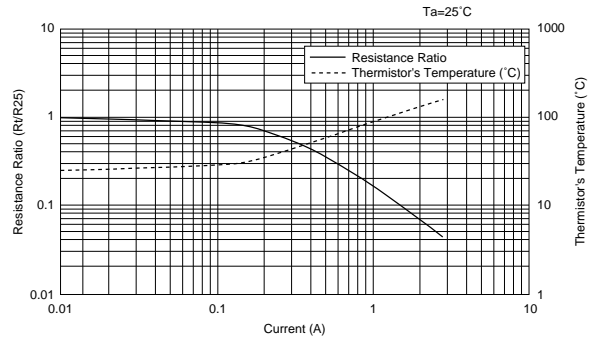

### ■ NTPAA8R2L Type

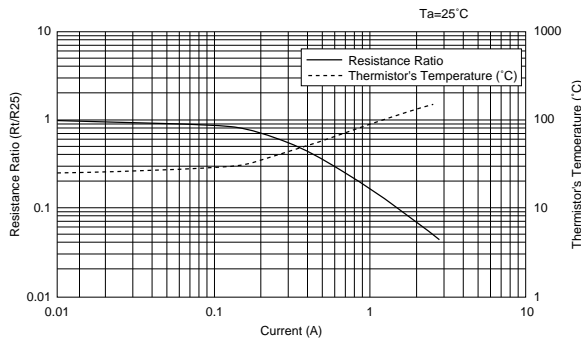

### ■ NTPAA100L Type

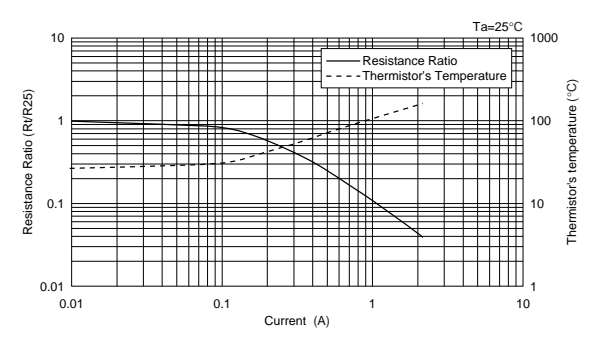

### ■ NTPA9160L Type

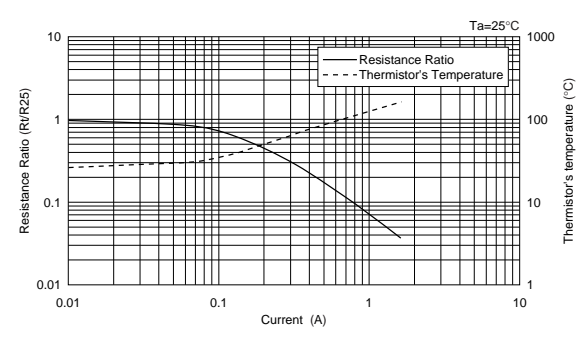

### ■ NTPA74R0L Type

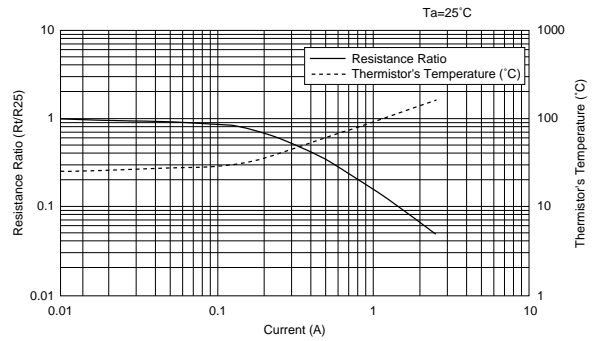

Continued on the following page. ↗

## Current-R Ratio (RT/R25) / Current-Temperature Characteristics (Typical)

Continued from the preceding page.

### ■ NTPA78R0L Type

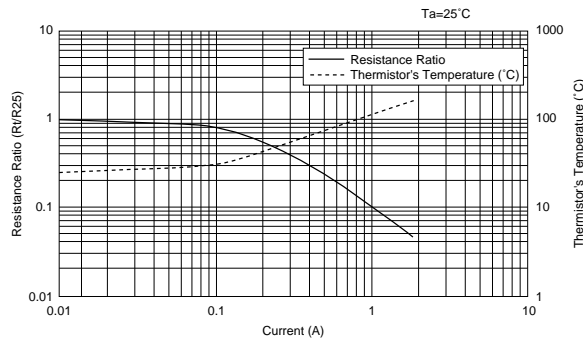

### ■ NTPA7160L Type

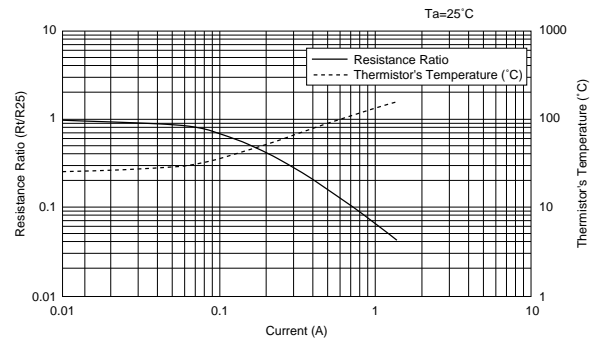

### ■ NTPA7220L Type

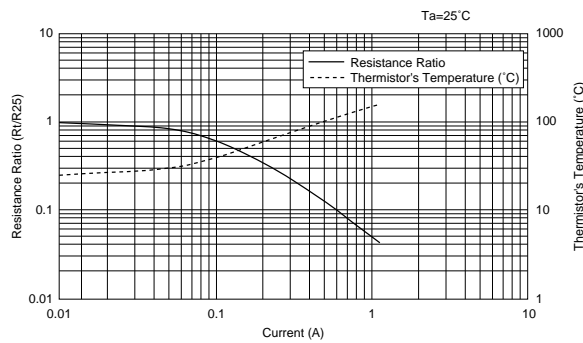

## for Inrush Current Suppression Lead Type ⚠Caution/Notice

### ■ ⚠Caution (Storage and Operating Conditions)

1. This product is designed for the Switching Power Supply with smoothing capacitors.  
Other applications of this product may result in fire.
2. Use this product within the specified maximum current. Otherwise it may catch fire in the worst case.
3. Use this product with smoothing capacitor within the specified maximum capacitance value. Otherwise it may catch fire in the worst case.
4. This product is designed for application in an ordinary environment (normal room temperature, humidity and atmospheric pressure).  
Do not use under the following conditions because

- all these factors can deteriorate the product characteristics cause failure and burn-out.
- (1) Corrosive gas or deoxidizing gas.  
(Chlorine gas, Hydrogen sulfide gas, Ammonia gas, Sulfuric acid gas, Nitric oxide gas, etc.)
  - (2) Volatile or flammable gas
  - (3) Dusty conditions
  - (4) Under high or low pressure
  - (5) Wet or humid conditions
  - (6) Near with salt water, oils, chemical liquids or organic solvents
  - (7) Strong vibrations
  - (8) Other places where similar hazardous conditions exist.

### ■ ⚠Caution (Others)

Be sure to provide an appropriate fail-safe function on your product to prevent secondary damages that may be caused by the abnormal function or the failure of our product.

### ■ Notice (Storage and Operating Conditions)

To keep solderability of product from declining, the following storage condition is recommended.

1. Storage condition:  
Temperature -10 to +40 degree C  
Humidity less than 75%RH (not dewing condition)
2. Storage term:  
Use this product within 6 months after delivery by first-in and first-out stocking system.

3. Handling after unpacking:  
After unpacking, reseal product promptly or store it in a sealed container with a drying agent.
4. Storage place:  
Do not store this product in corrosive gas (sulfuric acid gas, chlorine gas, etc.) or in direct sunlight.

### ■ Notice (Rating)

Use this product within the specified temperature range.  
Higher temperature may cause deterioration of the characteristics or the material quality of this product.

### ■ Notice (Soldering and Mounting)

1. Be sure that the preheat-up does not melt the soldering of this product. Excessive heat may cause failure to open, short or insulation break down.
2. Do not touch the body with soldering iron.  
The soldering point should be min. 5mm away from the root of lead wire.

## for Inrush Current Suppression Lead Type ⚠Caution/Notice

### ■ Notice (Handling)

1. When this product is operated, temperature of some area may be about 160 (degree C).  
Use proper surrounding parts and material which withstand such temperature. If they are inadequate and kept at high temperature for long time, they may be deteriorated or may produce harmful gas. And, such harmful gas may deteriorate the element of this product.
2. This product does not have waterproof construction. Splashed water may cause failure mode such as deterioration of characteristics or current leak. So, do not apply cleaning to immerse it into water or any solvent.
3. The ceramic element of this product is fragile, and care must be taken not to load an excessive press-force or not to give a shock at handling. Such forces may cause cracking or chipping to the element.
4. Do not apply an excessive force to the lead wire. Otherwise, it may cause break off junction between lead wire and element, or may crack element. So, fix lead wire of element side when lead wire is bent or cut.

### ■ Notice (Others)

1. This products need sufficient cool off time to recover high resistance. Repeated ON-OFF may cause over specified current rating.  
Make sure inrush current do not exceed the specified ratings even at the worst condition. (maximum ambient temperature and the shortest off time.)
2. The resin coating of this product does not guarantee insulating. Keep an adequate insulating distance to surrounding parts.

## for Inrush Current Suppression Lead Type Package

### ■ Minimum Quantity

Part Numbers	Minimum Quantity (pcs.)	
	Ammo Pack	Bulk
<b>NTPA7</b>	1000	100
<b>NTPA9</b>	1000	100
<b>NTPAA</b>	750	100
<b>NTPAD</b>	400	100
<b>NTPAJ</b>	-	100
<b>NTPAN</b>	-	100

### ■ Taping Dimensions (NTPAD/NTPAA Series)

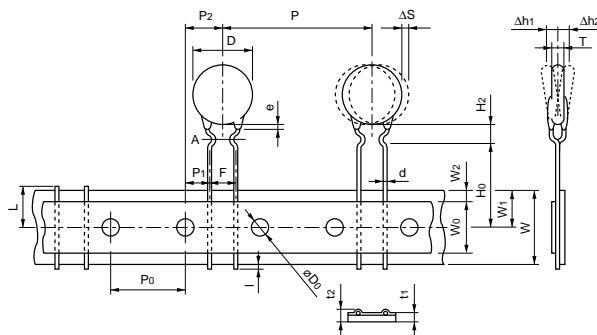

Item	Code	Dimensions (mm)
Pitch of Component	P	30.0
Pitch of Sprocket Hole	P <sub>0</sub>	15.0±0.3
Lead Spacing	F	7.5±0.5
Length from Hole Center to Component	P <sub>2</sub>	7.5±1.5
Length from Hole Center to Lead	P <sub>1</sub>	3.75±1.0
Body Diameter	D	(refer to the table below)
Thickness	T	(refer to the table below)
Deviation along Tape, Left or Right	ΔS	±2.0
Carrier Tape Width	W	18.0±0.5
Position of Sprocket Hole	W <sub>1</sub>	9.0±0.5
Lead Distance between Reference and Bottom Planes	H <sub>0</sub>	16.0±0.5
Height of Component	H <sub>2</sub>	10.0 max.
Overflow of Lead	I	+0.5 to -6.0
Diameter of Sprocket Hole	D <sub>0</sub>	4.0±0.1
Lead Diameter (Sn-Plated Cu Wire)	d	0.8±0.05
Total Tape Thickness	t <sub>1</sub>	0.6±0.3
Total Thickness, Tape and Lead Wire	t <sub>2</sub>	2.0 max.
Deviation across Tape	Δh <sub>1</sub> , Δh <sub>2</sub>	2.0 max.
Portion to cut in Case of Defect	L	11.0 <sup>+0</sup> <sub>-2.0</sub>
Hole Down Tape Width	W <sub>0</sub>	11.5 min.
Hole Down Tape Position	W <sub>2</sub>	4.0 max.
Coating Extension on Lead	e	to line A

Type	D	T
<b>NTPAD</b>	16.0 max.	5.5 max.
<b>NTPAA</b>	12.0 max.	5.0 max.

Continued on the following page.

## for Inrush Current Suppression Lead Type Package

Continued from the preceding page.

### Taping Dimensions (NTPA7/NTPA9 Series)

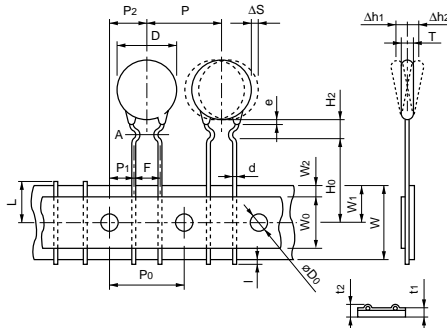

Item	Code	Dimensions (mm)
Pitch of Component	P	12.7
Pitch of Sprocket Hole	P <sub>0</sub>	12.7±0.3
Lead Spacing	F	5.0 <sup>+0.8</sup> <sub>-0.3</sub>
Length from Hole Center to Component	P <sub>2</sub>	6.35±1.3
Length from Hole Center to Lead	P <sub>1</sub>	3.85±0.8
Body Diameter	D	(refer to the table below)
Thickness	T	5.0 max.
Deviation along Tape, Left or Right	ΔS	±1.5
Carrier Tape Width	W	18.0±0.5
Position of Sprocket Hole	W <sub>1</sub>	9.0 <sup>+0.5</sup> <sub>-0.75</sub>
Lead Distance between Reference and Bottom Planes	H <sub>0</sub>	16.0±1.0
Height of Component	H <sub>2</sub>	6.0 max.
Overflow of Lead	I	+0.5 to -4.0
Diameter of Sprocket Hole	D <sub>0</sub>	4.0±0.3
Lead Diameter (Sn-Plated Cu Wire)	d	0.6±0.05
Total Tape Thickness	t <sub>1</sub>	0.6±0.3
Total Thickness, Tape and Lead Wire	t <sub>2</sub>	2.0 max.
Deviation across Tape	Δh <sub>1</sub> , Δh <sub>2</sub>	1.5 max.
Portion to cut in Case of Defect	L	11.0 <sup>+0</sup> <sub>-2.0</sub>
Hole Down Tape Width	W <sub>0</sub>	11.0 min.
Hole Down Tape Position	W <sub>2</sub>	4.0 max.
Coating Extension on Lead	e	to line A

Type	D
<b>NTPA9</b>	11.0 max.
<b>NTPA7</b>	9.0 max.

**⚠Note:**

1. Export Control

⟨For customers outside Japan⟩

No muRata products should be used or sold, through any channels, for use in the design, development, production, utilization, maintenance or operation of, or otherwise contribution to (1) any weapons (Weapons of Mass Destruction (nuclear, chemical or biological weapons or missiles) or conventional weapons) or (2) goods or systems specially designed or intended for military end-use or utilization by military end-users.

⟨For customers in Japan⟩

For products which are controlled items subject to the "Foreign Exchange and Foreign Trade Law" of Japan, the export license specified by the law is required for export.

2. Please contact our sales representatives or product engineers before using the products in this catalog for the applications listed below, which require especially high reliability for the prevention of defects which might directly damage a third party's life, body or property, or when one of our products is intended for use in applications other than those specified in this catalog.

- |                             |  |
|-----------------------------|--|
| ① Aircraft equipment        | ② Aerospace equipment  |
| ③ Undersea equipment        | ④ Power plant equipment  |
| ⑤ Medical equipment         | ⑥ Transportation equipment (vehicles, trains, ships, etc.)   |
| ⑦ Traffic signal equipment  | ⑧ Disaster prevention / crime prevention equipment   |
| ⑨ Data-processing equipment | ⑩ Application of similar complexity and/or reliability requirements to the applications listed above |

3. Product specifications in this catalog are as of January 2005. They are subject to change or our products in it may be discontinued without advance notice. Please check with our sales representatives or product engineers before ordering. If there are any questions, please contact our sales representatives or product engineers.

4. Please read rating and ⚠CAUTION (for storage, operating, rating, soldering, mounting and handling) in this catalog to prevent smoking and/or burning, etc.

5. This catalog has only typical specifications because there is no space for detailed specifications. Therefore, please approve our product specifications or transact the approval sheet for product specifications before ordering.

6. Please note that unless otherwise specified, we shall assume no responsibility whatsoever for any conflict or dispute that may occur in connection with the effect of our and/or a third party's intellectual property rights and other related rights in consideration of your use of our products and/or information described or contained in our catalogs. In this connection, no representation shall be made to the effect that any third parties are authorized to use the rights mentioned above under licenses without our consent.

7. No ozone depleting substances (ODS) under the Montreal Protocol are used in our manufacturing process.



**Murata Manufacturing Co., Ltd.**

<http://www.murata.com/>

**Head Office**  
1-10-1, Higashi Kotari, Nagaokakyo-shi, Kyoto 617-8555, Japan  
Phone: 81-75-951-9111

**International Division**  
3-29-12, Shibuya, Shibuya-ku, Tokyo 150-0002, Japan  
Phone: 81-3-5469-6123 Fax: 81-3-5469-6155 E-mail: [intl@murata.co.jp](mailto:intl@murata.co.jp)