

## PTC Thermistors, Mini Chips for Over-Temperature Protection



### FEATURES

- Well-defined protection temperature levels
- Fast reaction time (< 6 s in still air)
- Accurate resistance for ease of circuit design
- Excellent long term behavior (< 1 °C or 5 % after 1000 h at  $T_n + 15$  °C)
- Wide range of protection temperatures (70 °C to 170 °C)
- No need to reset supply after overtemperature switch
- Small size and rugged
- Coated leaded and naked devices available
- Compliant to RoHS directive 2002/95/EC and in accordance to WEEE 2002/96/EC



RoHS  
COMPLIANT

QUICK REFERENCE DATA		
PARAMETER	VALUE	UNIT
Maximum resistance at 25 °C	100	Ω
Minimum resistance at ( $T_n + 15$ ) °C	4000	Ω
Maximum (DC) voltage	30	V
Temperature range	- 20 to ( $T_n + 15$ )	°C
Weight:		
91002 to 91014	≈ 0.006	g
91072 to 91087	≈ 0.003	g
Climatic category	25/125/56	

### APPLICATIONS

Over-temperature protection and control in:

- Industrial electronics
- Power supplies
- Electronic data processing
- Motor protection

### DESCRIPTION

These directly heated thermistors have a positive temperature coefficient and are primarily intended for sensing.

### NOMINAL WORKING TEMPERATURES AND ORDERING INFORMATION

NOMINAL WORKING TEMPERATURE				CATALOG NUMBER 2381 671 .....	
$T_n$ (°C)	RESISTANCE from - 20 °C to $T_n - 20$ °C (Ω)	RESISTANCE at $T_n - 5$ °C (Ω)	RESISTANCE at $T_n + 5$ °C (kΩ)	NACKED CHIP <sup>(1)</sup>	
				1.0 x 1.0 (mm)	1.7 x 1.7 (mm)
70	30 to 250	50 to 570	0.57 to 50	91072	91002
80	30 to 250	50 to 550	1.33 to 50	91073 <sup>(2)</sup>	91003
90	30 to 250	50 to 550	1.33 to 50	91074	91004
100	30 to 250	50 to 550	1.33 to 50	91075	91005
110	30 to 250	50 to 550	1.33 to 50	91076	91006
120	30 to 250	50 to 550	1.33 to 50	91077	91007
125	30 to 250	50 to 550	1.33 to 50	91078	-
130	30 to 250	50 to 550	1.33 to 50	91079	91009
135	30 to 250	50 to 550	1.33 to 50	91081	-
140	30 to 250	50 to 550	1.33 to 50	91082	91012
145	30 to 250	50 to 550	1.33 to 50	91083	-
150	30 to 250	50 to 550	1.33 to 50	91084	91014
155	30 to 250	50 to 550	1.33 to 50	91085	91015
160	30 to 250	50 to 550	1.33 to 50	91086	91016
170	30 to 250	50 to 550	1.33 to 50	91087	91017

#### Notes

<sup>(1)</sup> Naked chips are packed in a hermetically-sealed alu-plastic bag

<sup>(2)</sup> Resistance at  $T_n - 5$  °C = 50 to 570 and Resistance at  $T_n + 5$  °C = 0.57 to 50

ELECTRICAL CHARACTERISTICS	
PARAMETER	VALUES
Maximum resistance at 25 °C	100 Ω
Maximum resistance at (T <sub>n</sub> - 5) °C	See Nominal Working Temperatures and Ordering Information table
Minimum resistance at (T <sub>n</sub> + 15) °C	4000 Ω
Minimum resistance at (T <sub>n</sub> + 5) °C	See Nominal Working Temperatures and Ordering Information table
Maximum voltage	30 V (AC or DC)

CATALOG NUMBERS AND PACKAGING				
12NC	SAP	12NC	SAP	SPQ
2381 671 91072	PTCSC10T071DBE	2381 671 91002	PTCSC17T071DBE	5000
2381 671 91073	PTCSC10T081DBE	2381 671 91003	PTCSC17T081DBE	5000
2381 671 91074	PTCSC10T091DBE	2381 671 91004	PTCSC17T091DBE	5000
2381 671 91075	PTCSC10T101DBE	2381 671 91005	PTCSC17T101DBE	5000
2381 671 91076	PTCSC10T111DBE	2381 671 91006	PTCSC17T111DBE	5000
2381 671 91077	PTCSC10T121DBE	2381 671 91007	PTCSC17T121DBE	5000
2381 671 91078	PTCSC10T125DBE	-	-	5000
2381 671 91079	PTCSC10T131DBE	2381 671 91009	PTCSC17T131DBE	5000
2381 671 91081	PTCSC10T135DBE	-	-	5000
2381 671 91082	PTCSC10T141DBE	2381 671 91012	PTCSC17T141DBE	5000
2381 671 91083	PTCSC10T145DBE	-	-	5000
2381 671 91084	PTCSC10T151DBE	2381 671 91014	PTCSC17T151DBE	5000
2381 671 91085	PTCSC10T155DBE	2381 671 91015	PTCSC17T155DBE	5000
2381 671 91086	PTCSC10T161DBE	2381 671 91016	PTCSC17T161DBE	5000
2381 671 91087	PTCSC10T171DBE	2381 671 91017	PTCSC17T171DBE	5000

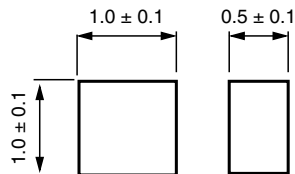
**COMPONENT OUTLINES DIMENSIONS**  
 in millimeters

Component outline for 91071 to 91087

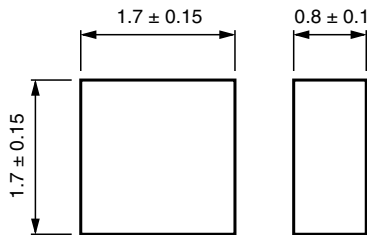

Component outline for 91002 to 91017

For clamping, reflow or hand soldering. Not intended for either wave or ultrasonic soldering and not for spot welding.

All standard solder alloys with low activated halogene-free fluxes are acceptable, for example: 62Sn/36Pb/2Ag.

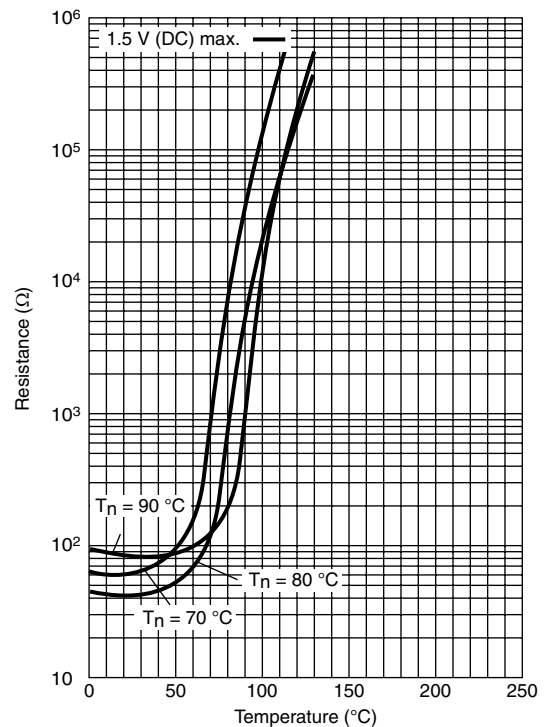
**TYPICAL RESISTANCE/TEMPERATURE CHARACTERISTIC FOR 2381 671 91..2, 91..3 and 91..4**

**TYPICAL RESISTANCE/TEMPERATURE CHARACTERISTIC FOR 2381 671 91..5, 91..6 and 91..7**

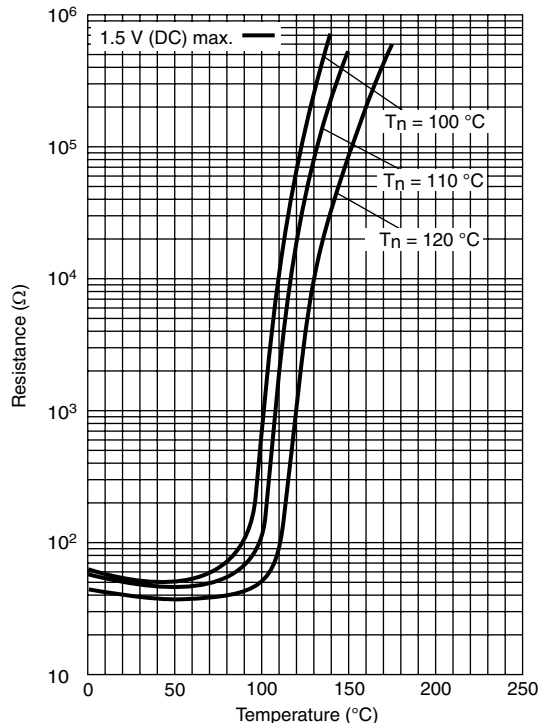

**TYPICAL RESISTANCE/TEMPERATURE CHARACTERISTIC FOR 2381 671 91078, 91..9 and 91081**

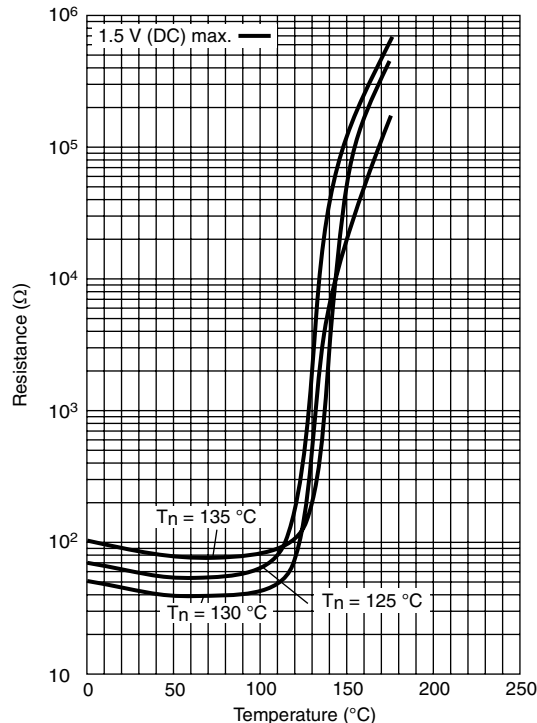

**TYPICAL RESISTANCE/TEMPERATURE CHARACTERISTIC FOR 2381 671 91..2, 91083 and 91..4**

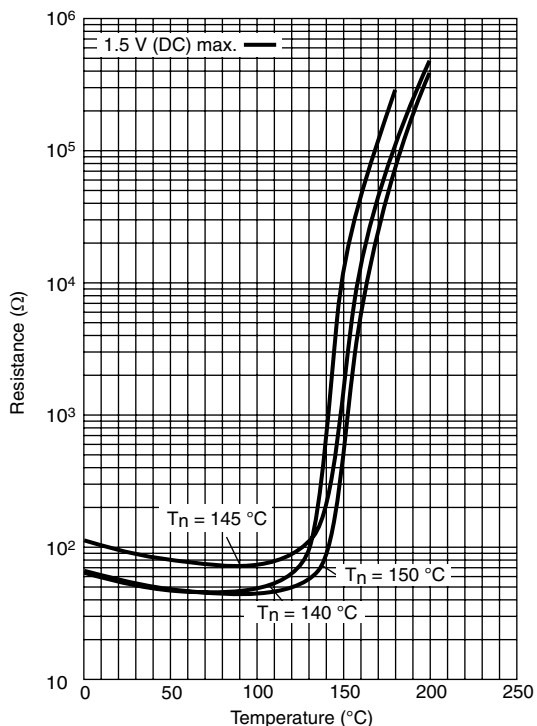

**TYPICAL RESISTANCE/TEMPERATURE CHARACTERISTIC FOR 2381 671 91..5, 91..6 and 91..7**

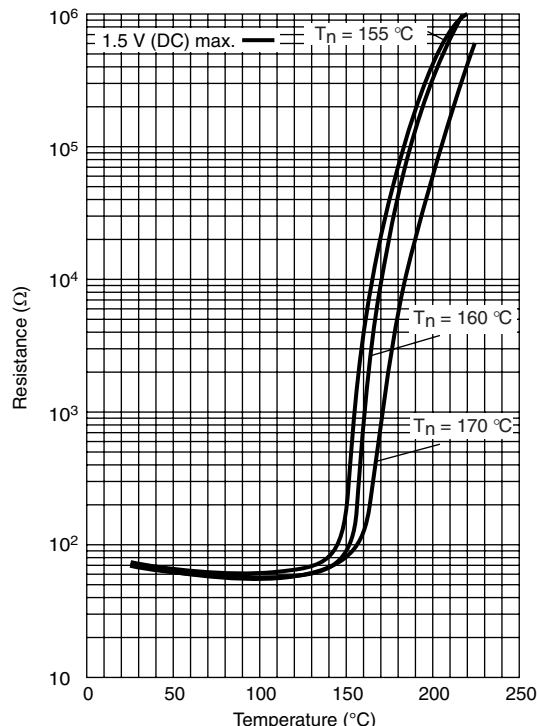

**APPLICATION SPECIFIC DATA**

Negative Temperature Coefficient (NTC) thermistors are well known for temperature sensing. What is not well known, however, is that Positive Temperature Coefficient (PTC) thermistors can be used for thermal protection. Although their operating principles are similar, the applications are very different; whereas NTC thermistors sense and measure temperature over a defined range, PTC thermistors switch at one particular temperature.

Just like thermostats they protect such equipment and components as motors, transformers, power transistors and thyristors against overtemperature. A PTC thermistor is less expensive than a thermostat, and its switch temperature can be more accurately specified. It is also smaller and easier to design-in to electronic circuitry.

The PTC thermistor is mounted in thermal contact with the equipment to be protected, and connected into the bridge arm of a comparator circuit, such as shown in Fig. 1. At normal temperature, the PTC thermistor resistance ( $R_p$ ) is lower than  $R_s$  (see Fig. 2), so the comparator's output voltage  $V_o$  will be low. If an equipment overtemperature occurs, the PTC thermistor will quickly heat up to its trigger or nominal reference temperature  $T_n$ , whereupon its resistance will increase to a value much higher than  $R_s$ , causing  $V_o$  to switch to a high level sufficient to activate an alarm, relay or power shutdown circuit.

**APPLICATION EXAMPLES**

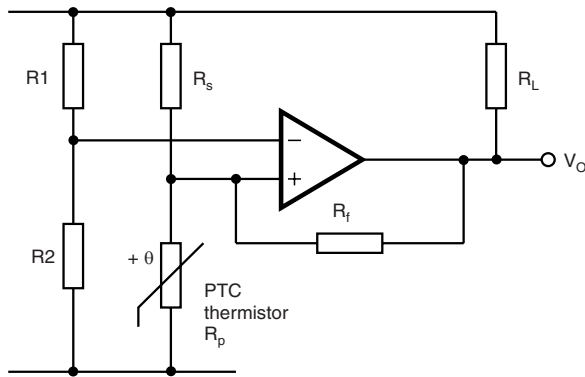

Fig. 1 Typical comparator circuit

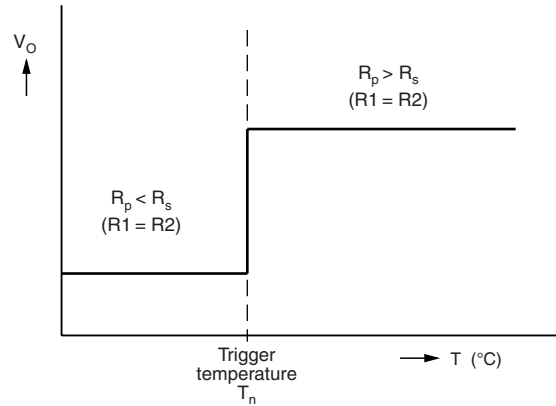
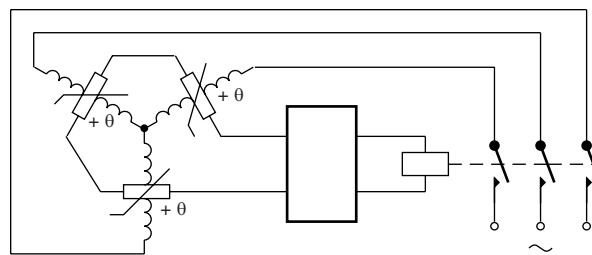

Fig. 2 Typical switch characteristic



As soon as one or more of the windings becomes too hot, the motor is switched off.

Fig. 3 Temperature protection of electric motors



## Disclaimer

All product specifications and data are subject to change without notice.

Vishay Intertechnology, Inc., its affiliates, agents, and employees, and all persons acting on its or their behalf (collectively, "Vishay"), disclaim any and all liability for any errors, inaccuracies or incompleteness contained herein or in any other disclosure relating to any product.

Vishay disclaims any and all liability arising out of the use or application of any product described herein or of any information provided herein to the maximum extent permitted by law. The product specifications do not expand or otherwise modify Vishay's terms and conditions of purchase, including but not limited to the warranty expressed therein, which apply to these products.

No license, express or implied, by estoppel or otherwise, to any intellectual property rights is granted by this document or by any conduct of Vishay.

The products shown herein are not designed for use in medical, life-saving, or life-sustaining applications unless otherwise expressly indicated. Customers using or selling Vishay products not expressly indicated for use in such applications do so entirely at their own risk and agree to fully indemnify Vishay for any damages arising or resulting from such use or sale. Please contact authorized Vishay personnel to obtain written terms and conditions regarding products designed for such applications.

Product names and markings noted herein may be trademarks of their respective owners.