

### Multilayer NTC Thermistors

Series: **ERTJ**

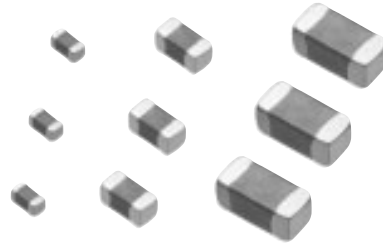

#### ■ Features

- Surface Mount Device (0201, 0402, 0603)
- Highly reliable multilayer / monolithic structure
- Wide temperature operating range (-40 to 125 °C)
- Environmentally-friendly lead-free

#### ■ Recommended Applications

- Mobile Phone
  - Temperature compensation for crystal oscillator
  - Temperature compensation for semiconductor devices
- Personal Computer
  - Temperature detection for CPU and memory device
  - Temperature compensation for ink-viscosity (Inkjet Printer)
- Battery Pack
  - Temperature detection of battery cells
- Liquid Crystal Display
  - Temperature compensation of display contrast
  - Temperature compensation of display backlighting (CCFL)

#### ■ Handling Precautions

Please see Pages 371 to 375

#### ■ Packaging Methods

Please see Page 364

#### ■ Explanation of Part Numbers

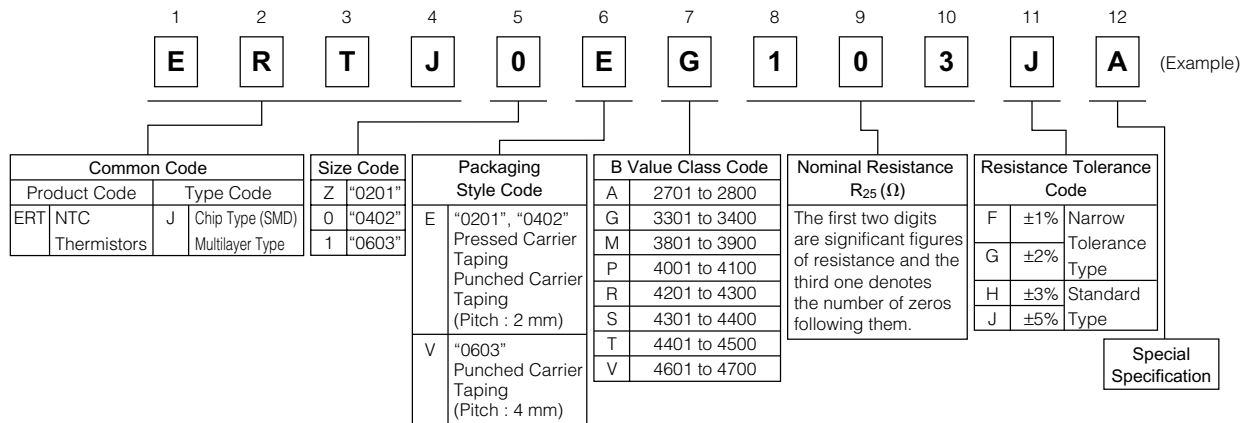

#### ■ Construction

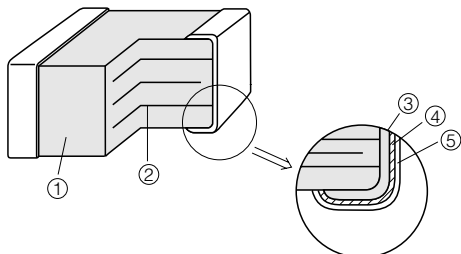

| No | Name                    |                        |
|----|-------------------------|------------------------|
| ①  | Semiconductive Ceramics |                        |
| ②  | Internal electrode      |                        |
| ③  | Terminal electrode      | Substrate electrode    |
| ④  |                         | Intermediate electrode |
| ⑤  |                         | External electrode     |

Design and specifications are each subject to change without notice. Ask factory for the current technical specifications before purchase and/or use. Should a safety concern arise regarding this product, please be sure to contact us immediately.

00 Sep. 2010

### ■ Dimensions in mm (not to scale)

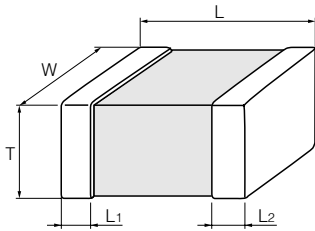

| Size Code (EIA) | L         | W         | T         | L <sub>1</sub> , L <sub>2</sub> |
|-----------------|-----------|-----------|-----------|---------------------------------|
| Z(0201)         | 0.60±0.03 | 0.30±0.03 | 0.30±0.03 | 0.15±0.05                       |
| 0(0402)         | 1.0±0.1   | 0.50±0.05 | 0.50±0.05 | 0.25±0.15                       |
| 1(0603)         | 1.60±0.15 | 0.8±0.1   | 0.8±0.1   | 0.3±0.2                         |

(Unit : mm)

### ■ Packaging Methods

#### ● Standard Packing Quantities

| Size Code | Thickness (mm) | Kind of Taping         | Pitch (mm) | Quantity (pcs./reel) |
|-----------|----------------|------------------------|------------|----------------------|
| Z(0201)   | 0.3            | Pressed Carrier Taping | 2          | 15,000               |
| 0(0402)   | 0.5            | Punched Carrier Taping | 2          | 10,000               |
| 1(0603)   | 0.8            |                        | 4          | 4,000                |

#### ● Reel for Taping

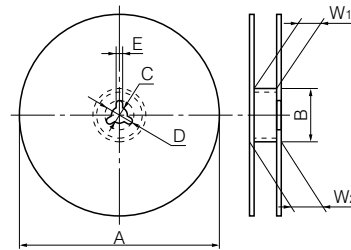

| Symbol    | φA                             | φB                                | C        | D        | E       | W <sub>1</sub>                   | W <sub>2</sub> |
|-----------|--------------------------------|-----------------------------------|----------|----------|---------|----------------------------------|----------------|
| Dim. (mm) | 180 <sup>0</sup> <sub>-3</sub> | 60.0 <sup>+1.0</sup> <sub>0</sub> | 13.0±0.5 | 21.0±0.8 | 2.0±0.5 | 9.0 <sup>+1.0</sup> <sub>0</sub> | 11.4±1.0       |

#### ● Pitch 2 mm (Pressed Carrier Taping) : Size 0201

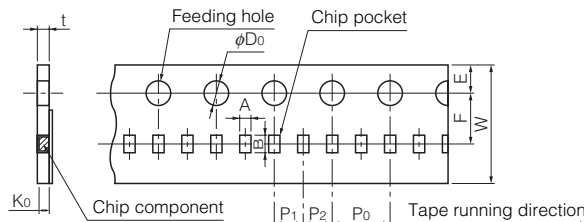

| Symbol    | A         | B         | W       | F         | E         | P <sub>1</sub> | P <sub>2</sub> | P <sub>0</sub> | φD <sub>0</sub>                  | t         | K <sub>0</sub> |
|-----------|-----------|-----------|---------|-----------|-----------|----------------|----------------|----------------|----------------------------------|-----------|----------------|
| Dim. (mm) | 0.36±0.03 | 0.66±0.03 | 8.0±0.2 | 3.50±0.05 | 1.75±0.10 | 2.00±0.05      | 2.00±0.05      | 4.0±0.1        | 1.5 <sup>+0.1</sup> <sub>0</sub> | 0.55 max. | 0.36±0.03      |

#### ● Pitch 2 mm (Punched Carrier Taping) : Size 0402

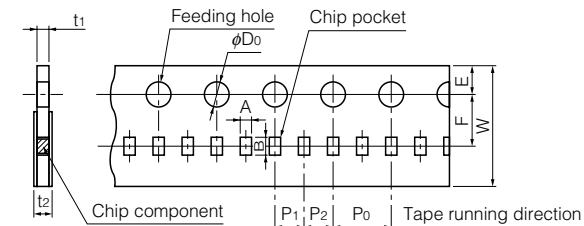

| Symbol    | A         | B         | W       | F         | E         | P <sub>1</sub> | P <sub>2</sub> | P <sub>0</sub> | φD <sub>0</sub>                  | t <sub>1</sub> | t <sub>2</sub> |
|-----------|-----------|-----------|---------|-----------|-----------|----------------|----------------|----------------|----------------------------------|----------------|----------------|
| Dim. (mm) | 0.62±0.05 | 1.12±0.05 | 8.0±0.2 | 3.50±0.05 | 1.75±0.10 | 2.00±0.05      | 2.00±0.05      | 4.0±0.1        | 1.5 <sup>+0.1</sup> <sub>0</sub> | 0.7 max.       | 1.0 max.       |

#### ● Pitch 4 mm (Punched Carrier Taping) : Size 0603

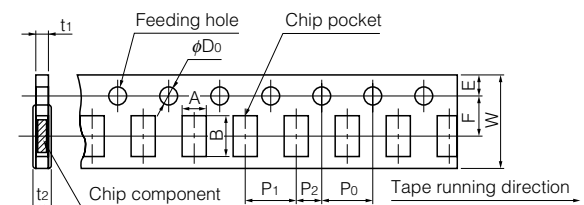

| Symbol    | A       | B       | W       | F         | E         | P <sub>1</sub> | P <sub>2</sub> | P <sub>0</sub> | φD <sub>0</sub>                  | t <sub>1</sub> | t <sub>2</sub> |
|-----------|---------|---------|---------|-----------|-----------|----------------|----------------|----------------|----------------------------------|----------------|----------------|
| Dim. (mm) | 1.0±0.1 | 1.8±0.1 | 8.0±0.2 | 3.50±0.05 | 1.75±0.10 | 4.0±0.1        | 2.00±0.05      | 4.0±0.1        | 1.5 <sup>+0.1</sup> <sub>0</sub> | 1.1 max.       | 1.4 max.       |

#### ● Leader Part and Taped End

##### Leader part

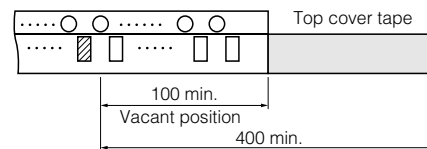

##### Taped end

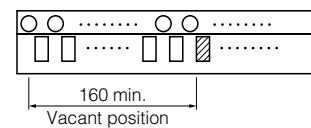

(Unit : mm)

### ■ Minimum Quantity / Packing Unit

| Part Number (Size) | Minimum Quantity / Packing Unit | Packing Quantity in Carton | Carton L×W×H (mm) |
|--------------------|---------------------------------|----------------------------|-------------------|
| ERTJZ (0201)       | 15,000                          | 300,000                    | 250×200×200       |
| ERTJ0 (0402)       | 10,000                          | 200,000                    | 250×200×200       |
| ERTJ1 (0603)       | 4,000                           | 80,000                     | 250×200×200       |

Part No., quantity and country of origin are designated on outer packages in English.

### ■ Ratings

| Size code (EIA)                   | Z(0201)               | 0(0402)               | 1(0603)               |
|-----------------------------------|-----------------------|-----------------------|-----------------------|
| Operating Temperature Range       | -40 to 125 °C         |                       |                       |
| Rated Maximum Power Dissipation*1 | 33 mW                 | 66 mW                 | 100 mW                |
| Dissipation Factor*2              | approximately 1 mW/°C | approximately 2 mW/°C | approximately 3 mW/°C |

\*1 Rated Maximum Power Dissipation : The maximum power that can be continuously applied at the rated ambient temperature.  
 · The Maximum Power Dissipation under ambient temperature 25 °C or less is the same with the rated maximum power dissipation, and Maximum power dissipation beyond 25 °C depends on the Decreased power dissipation curve.  
 · Please see "Operating Power" for details paging 371.

\*2 Dissipation factor : The constant amount power required to raise the temperature of the Thermistor 1 °C through self heat generation under stable temperatures.  
 · Dissipation factor is the reference value when mounted on a glass epoxy board (1.6 mmT).

### ● Resistance ratios to R<sub>25</sub> at each temperature/Reference values

(for obtaining resistance at each temperature by using R<sub>25</sub> shown in part number)

|                    | ERTJ□□A~ |          | ERTJ□□G~ | ERTJ□□M~ | ERTJ□□P~ | ERTJ□□R~ | ERTJ0ES~ | ERTJ1VS~ | ERTJ□□T~ | ERTJ0ET104□ | ERTJ□□V~ |
|--------------------|----------|----------|----------|----------|----------|----------|----------|----------|----------|-------------|----------|
| B <sub>25/50</sub> | 2750 K   | 2800 K   | (3375 K) | 3900 K   | 4050 K   | 4250K    | 4330K    | (4330K)  | 4500K    | 4500K       | 4700K    |
| B <sub>25/85</sub> | (2700 K) | (2750 K) | 3435 K   | (3970 K) | (4100 K) | (4300K)  | (4390K)  | 4390K    | (4450K)  | (4580K)     | (4750K)  |
| T(°C)              |          |          |          |          |          |          |          |          | *1       | *2          |          |
| -40                | 13.05    | 13.28    | 20.52    | 32.11    | 33.10    | 43.10    | 45.67    | 45.53    | 63.30    | 47.07       | 59.76    |
| -35                | 10.21    | 10.40    | 15.48    | 23.29    | 24.03    | 30.45    | 32.08    | 31.99    | 42.92    | 33.31       | 41.10    |
| -30                | 8.061    | 8.214    | 11.79    | 17.08    | 17.63    | 21.76    | 22.80    | 22.74    | 29.50    | 23.80       | 28.61    |
| -25                | 6.427    | 6.547    | 9.069    | 12.65    | 13.06    | 15.73    | 16.39    | 16.35    | 20.53    | 17.16       | 20.14    |
| -20                | 5.168    | 5.261    | 7.037    | 9.465    | 9.761    | 11.48    | 11.91    | 11.89    | 14.46    | 12.49       | 14.33    |
| -15                | 4.191    | 4.261    | 5.507    | 7.147    | 7.362    | 8.466    | 8.743    | 8.727    | 10.30    | 9.159       | 10.31    |
| -10                | 3.424    | 3.476    | 4.344    | 5.444    | 5.599    | 6.300    | 6.479    | 6.469    | 7.407    | 6.772       | 7.482    |
| -5                 | 2.819    | 2.856    | 3.453    | 4.181    | 4.291    | 4.730    | 4.845    | 4.839    | 5.388    | 5.046       | 5.481    |
| 0                  | 2.336    | 2.362    | 2.764    | 3.237    | 3.312    | 3.582    | 3.654    | 3.650    | 3.966    | 3.789       | 4.050    |
| 5                  | 1.948    | 1.966    | 2.227    | 2.524    | 2.574    | 2.734    | 2.778    | 2.776    | 2.953    | 2.864       | 3.015    |
| 10                 | 1.635    | 1.646    | 1.806    | 1.981    | 2.013    | 2.102    | 2.128    | 2.126    | 2.221    | 2.179       | 2.262    |
| 15                 | 1.380    | 1.386    | 1.474    | 1.567    | 1.584    | 1.629    | 1.642    | 1.641    | 1.687    | 1.669       | 1.710    |
| 20                 | 1.171    | 1.174    | 1.211    | 1.247    | 1.255    | 1.272    | 1.277    | 1.276    | 1.293    | 1.287       | 1.303    |
| 25                 | 1        | 1        | 1        | 1        | 1        | 1        | 1        | 1        | 1        | 1           | 1        |
| 30                 | 0.8585   | 0.8565   | 0.8309   | 0.8072   | 0.8016   | 0.7921   | 0.7888   | 0.7890   | 0.7799   | 0.7823      | 0.7734   |
| 35                 | 0.7407   | 0.7372   | 0.6941   | 0.6556   | 0.6461   | 0.6315   | 0.6263   | 0.6266   | 0.6131   | 0.6158      | 0.6023   |
| 40                 | 0.6422   | 0.6376   | 0.5828   | 0.5356   | 0.5235   | 0.5067   | 0.5004   | 0.5007   | 0.4856   | 0.4876      | 0.4721   |
| 45                 | 0.5595   | 0.5541   | 0.4916   | 0.4401   | 0.4266   | 0.4090   | 0.4022   | 0.4025   | 0.3874   | 0.3884      | 0.3723   |
| 50                 | 0.4899   | 0.4836   | 0.4165   | 0.3635   | 0.3496   | 0.3319   | 0.3251   | 0.3254   | 0.3111   | 0.3111      | 0.2954   |
| 55                 | 0.4309   | 0.4238   | 0.3543   | 0.3018   | 0.2881   | 0.2709   | 0.2642   | 0.2645   | 0.2513   | 0.2504      | 0.2356   |
| 60                 | 0.3806   | 0.3730   | 0.3027   | 0.2518   | 0.2386   | 0.2222   | 0.2158   | 0.2161   | 0.2042   | 0.2026      | 0.1889   |
| 65                 | 0.3376   | 0.3295   | 0.2595   | 0.2111   | 0.1985   | 0.1832   | 0.1772   | 0.1774   | 0.1670   | 0.1648      | 0.1523   |
| 70                 | 0.3008   | 0.2922   | 0.2233   | 0.1777   | 0.1659   | 0.1518   | 0.1463   | 0.1465   | 0.1377   | 0.1348      | 0.1236   |
| 75                 | 0.2691   | 0.2600   | 0.1929   | 0.1504   | 0.1393   | 0.1264   | 0.1213   | 0.1215   | 0.1144   | 0.1108      | 0.1009   |
| 80                 | 0.2417   | 0.2322   | 0.1672   | 0.1278   | 0.1174   | 0.1057   | 0.1011   | 0.1013   | 0.09560  | 0.09162     | 0.08284  |
| 85                 | 0.2180   | 0.2081   | 0.1451   | 0.1090   | 0.09937  | 0.08873  | 0.08469  | 0.08486  | 0.08033  | 0.07609     | 0.06834  |
| 90                 | 0.1974   | 0.1871   | 0.1261   | 0.09310  | 0.08442  | 0.07468  | 0.07122  | 0.07138  | 0.06782  | 0.06345     | 0.05662  |
| 95                 | 0.1793   | 0.1688   | 0.1097   | 0.07980  | 0.07200  | 0.06307  | 0.06014  | 0.06028  | 0.05753  | 0.05314     | 0.04712  |
| 100                | 0.1636   | 0.1528   | 0.09563  | 0.06871  | 0.06166  | 0.05353  | 0.05099  | 0.05112  | 0.04903  | 0.04472     | 0.03939  |
| 105                | 0.1498   | 0.1387   | 0.08357  | 0.05947  | 0.05306  | 0.04568  | 0.04340  | 0.04351  | 0.04198  | 0.03784     | 0.03308  |
| 110                | 0.1377   | 0.1263   | 0.07317  | 0.05170  | 0.04587  | 0.03918  | 0.03708  | 0.03718  | 0.03609  | 0.03218     | 0.02791  |
| 115                | 0.1270   | 0.1153   | 0.06421  | 0.04512  | 0.03979  | 0.03374  | 0.03179  | 0.03188  | 0.03117  | 0.02748     | 0.02364  |
| 120                | 0.1175   | 0.1056   | 0.05650  | 0.03951  | 0.03460  | 0.02916  | 0.02734  | 0.02742  | 0.02702  | 0.02352     | 0.02009  |
| 125                | 0.1091   | 0.09695  | 0.04986  | 0.03470  | 0.03013  | 0.02527  | 0.02359  | 0.02367  | 0.02351  | 0.02017     | 0.01712  |

\*1 Other than ERTJ0ET104□ in B<sub>25/50</sub> = 4500K.

\*2 ERTJ0ET104□ only.

$$B_{25/50} = \frac{\ln(R_{25}/R_{50})}{1/298.15 - 1/323.15}$$

$$B_{25/85} = \frac{\ln(R_{25}/R_{85})}{1/298.15 - 1/358.15}$$

R<sub>25</sub>=Resistance at 25.0±0.1 °C  
 R<sub>50</sub>=Resistance at 50.0±0.1 °C  
 R<sub>85</sub>=Resistance at 85.0±0.1 °C

Design and specifications are each subject to change without notice. Ask factory for the current technical specifications before purchase and/or use.  
 Should a safety concern arise regarding this product, please be sure to contact us immediately.

### ■ Specification and Test Method

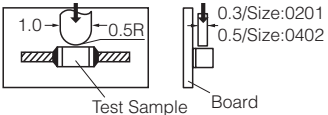
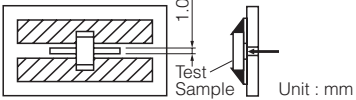
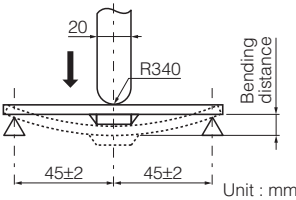
| Item   | Specification   | Test Method   |                  |                |                        |                    |              |                |                    |              |   |      |           |            |   |           |            |   |            |            |
|--|---|---|------------------|----------------|------------------------|--------------------|--------------|----------------|--------------------|--------------|---|------|-----------|------------|---|-----------|------------|---|------------|------------|
| Rated Zero-power Resistance (R <sub>25</sub> ) | Within the specified tolerance.   | The value of the d.c. resistance shall be measured at the rated ambient temperature of 25.0 ±0.1 °C under the power less than 0.1mW which is negligible self heat generation.   |                  |                |                        |                    |              |                |                    |              |   |      |           |            |   |           |            |   |            |            |
| B Value  | Within the specified tolerance.<br>* Individual Specification shall specify B <sub>25/50</sub> or B <sub>25/85</sub> .  | The Zero-power resistances; R <sub>1</sub> and R <sub>2</sub> , shall be measured respectively at T <sub>1</sub> (°C) and T <sub>2</sub> (°C). The B value is calculated by the following equation.<br>$B_{T_1/T_2} = \frac{\ln(R_1) - \ln(R_2)}{1/(T_1 + 273.15) - 1/(T_2 + 273.15)}$ <table border="1"> <thead> <tr> <th></th> <th>T<sub>1</sub></th> <th>T<sub>2</sub></th> </tr> </thead> <tbody> <tr> <td>B<sub>25/50</sub></td> <td>25.0 ±0.1 °C</td> <td>50.0 ±0.1 °C</td> </tr> <tr> <td>B<sub>25/85</sub></td> <td>25.0 ±0.1 °C</td> <td>85.0 ±0.1 °C</td> </tr> </tbody> </table> |                  | T <sub>1</sub> | T <sub>2</sub>         | B <sub>25/50</sub> | 25.0 ±0.1 °C | 50.0 ±0.1 °C   | B <sub>25/85</sub> | 25.0 ±0.1 °C | 85.0 ±0.1 °C  |      |           |            |   |           |            |   |            |            |
|  | T <sub>1</sub>  | T <sub>2</sub>  |                  |                |                        |                    |              |                |                    |              |   |      |           |            |   |           |            |   |            |            |
| B <sub>25/50</sub>                             | 25.0 ±0.1 °C  | 50.0 ±0.1 °C  |                  |                |                        |                    |              |                |                    |              |   |      |           |            |   |           |            |   |            |            |
| B <sub>25/85</sub>                             | 25.0 ±0.1 °C  | 85.0 ±0.1 °C  |                  |                |                        |                    |              |                |                    |              |   |      |           |            |   |           |            |   |            |            |
| Adhesion                                       | The terminal electrode shall be free from peeling or signs of peeling.  | Applied force :<br>Size 0201 : 2 N<br>Size 0402, 0603 : 5 N<br>Duration : 10 s<br><br>Size : 0201, 0402<br><br>Size : 0603<br><br>Unit : mm  |                  |                |                        |                    |              |                |                    |              |   |      |           |            |   |           |            |   |            |            |
| Bending Strength                               | There shall be no cracks and other mechanical damage.<br>R <sub>25</sub> change : within ±5 %   | Bending distance : 1 mm<br>Bending speed : 1 mm/s<br><br>Unit : mm  |                  |                |                        |                    |              |                |                    |              |   |      |           |            |   |           |            |   |            |            |
| Resistance to Soldering Heat                   | There shall be no cracks and other mechanical damage.<br><table border="1"> <thead> <tr> <th></th> <th>Narrow Tol. type</th> <th>Standard type</th> </tr> </thead> <tbody> <tr> <td>R<sub>25</sub> change</td> <td>: within ±2 %</td> <td>within ±3 %</td> </tr> <tr> <td>B Value change</td> <td>: within ±1 %</td> <td>within ±2 %</td> </tr> </tbody> </table> |   | Narrow Tol. type | Standard type  | R <sub>25</sub> change | : within ±2 %      | within ±3 %  | B Value change | : within ±1 %      | within ±2 %  | Soldering bath method<br>Solder temperature : 270 ±5 °C<br>Dipping period : 3.0 ±0.5 s<br>Preheat condition :<br><table border="1"> <thead> <tr> <th>Step</th> <th>Temp (°C)</th> <th>Period (s)</th> </tr> </thead> <tbody> <tr> <td>1</td> <td>80 to 100</td> <td>120 to 180</td> </tr> <tr> <td>2</td> <td>150 to 200</td> <td>120 to 180</td> </tr> </tbody> </table> | Step | Temp (°C) | Period (s) | 1 | 80 to 100 | 120 to 180 | 2 | 150 to 200 | 120 to 180 |
|  | Narrow Tol. type  | Standard type   |                  |                |                        |                    |              |                |                    |              |   |      |           |            |   |           |            |   |            |            |
| R <sub>25</sub> change                         | : within ±2 %   | within ±3 %   |                  |                |                        |                    |              |                |                    |              |   |      |           |            |   |           |            |   |            |            |
| B Value change                                 | : within ±1 %   | within ±2 %   |                  |                |                        |                    |              |                |                    |              |   |      |           |            |   |           |            |   |            |            |
| Step   | Temp (°C)   | Period (s)  |                  |                |                        |                    |              |                |                    |              |   |      |           |            |   |           |            |   |            |            |
| 1  | 80 to 100   | 120 to 180  |                  |                |                        |                    |              |                |                    |              |   |      |           |            |   |           |            |   |            |            |
| 2  | 150 to 200  | 120 to 180  |                  |                |                        |                    |              |                |                    |              |   |      |           |            |   |           |            |   |            |            |
| Solderability                                  | More than 75 % of the soldered area of both terminal electrodes shall be covered with fresh solder.   | Soldering bath method<br>Solder temperature : 230 ±5 °C<br>Dipping period : 4 ±1 s<br>Solder : H63A (JIS-Z-3282)  |                  |                |                        |                    |              |                |                    |              |   |      |           |            |   |           |            |   |            |            |

## ■ Specification and Test Method

| Item                | Specification  |   | Test Method  |
|---------------------|--|---|--|
| Temperature Cycling | Narrow Tol. type<br>R <sub>25</sub> change : within ±2 %<br>B Value change : within ±1 % | Standard type<br>within ±3 %<br>within ±2 % | Conditions of one cycle<br>Step 1 : -40 °C, 30±3 min<br>Step 2 : Room temp., 3 min max.<br>Step 3 : 125 °C, 30±3 min.<br>Step 4 : Room temp., 3 min max.<br>Number of cycles: 100 cycles |
| Moisture Resistance | Narrow Tol. type<br>R <sub>25</sub> change : within ±2 %<br>B Value change : within ±1 % | Standard type<br>within ±3 %<br>within ±2 % | Temperature : 85 ±2 °C<br>Relative humidity : 85 ±5 %<br>Test period : 1000 +48/0 h  |
| Damp Heat Load      | Narrow Tol. type<br>R <sub>25</sub> change : within ±2 %<br>B Value change : within ±1 % | Standard type<br>within ±3 %<br>within ±2 % | Temperature : 85 ±2 °C<br>Relative humidity : 85 ±5 %<br>Applied power : 10 mW<br>Test period : 500 +24/0 h  |
| Cold Resistance     | Narrow Tol. type<br>R <sub>25</sub> change : within ±2 %<br>B Value change : within ±1 % | Standard type<br>within ±3 %<br>within ±2 % | Temperature : -40 ±3 °C<br>Test period : 1000 +48/0 h  |
| Dry Heat Resistance | Narrow Tol. type<br>R <sub>25</sub> change : within ±2 %<br>B Value change : within ±1 % | Standard type<br>within ±3 %<br>within ±2 % | Temperature : 125 ±3 °C<br>Test period : 1000 +48/0 h  |

## ■ Part Number List of Narrow Tolerance Type (Resistance Tolerance : ±2 %, ±1 %)

### ● 0201(EIA)

| Nominal Resistance at 25 °C | Resistance Tolerance       | B value class code                      |  | G                      | P                      | V                      |
|-----------------------------|----------------------------|---|--|------------------------|------------------------|------------------------|
|                             |                            | Nominal B value<br>*( ) Reference value | B <sub>25/50</sub><br>B <sub>25/85</sub> | (3375 K)<br>3435 K±1 % | 4050 K±1 %<br>(4100 K) | 4700 K±1 %<br>(4750 K) |
| 10 kΩ                       | ±1 % (F)<br>or<br>±2 % (G) |   |  | ERTJZEG103□A           |                        |                        |
| 47 kΩ                       |                            |   |  |                        | ERTJZEP473□            |                        |
| 100 kΩ                      |                            |   |  |                        |                        | ERTJZEV104□            |

□ : Resistance Tolerance Code  
Avoid flow soldering.

### ● 0402(EIA)

| Nominal Resistance at 25 °C | Resistance Tolerance       | B value class code                      |  | G                      | P                      | S                      | V                      |
|-----------------------------|----------------------------|---|--|------------------------|------------------------|------------------------|------------------------|
|                             |                            | Nominal B value<br>*( ) Reference value | B <sub>25/50</sub><br>B <sub>25/85</sub> | (3375 K)<br>3435 K±1 % | 4050 K±1 %<br>(4100 K) | 4330 K±1 %<br>(4390 K) | 4700 K±1 %<br>(4750 K) |
| 10 kΩ                       | ±1 % (F)<br>or<br>±2 % (G) |   |  | ERTJ0EG103□A           |                        |                        |                        |
| 47 kΩ                       |                            |   |  |                        | ERTJ0EP473□            |                        |                        |
| 100 kΩ                      |                            |   |  |                        |                        | ERTJ0ES104□            | ERTJ0EV104□            |

□ : Resistance Tolerance Code  
Avoid flow soldering.

### ● 0603(EIA)

| Nominal Resistance at 25 °C | Resistance Tolerance       | B value class code                      |  | G                      | S                      |
|-----------------------------|----------------------------|---|--|------------------------|------------------------|
|                             |                            | Nominal B value<br>*( ) Reference value | B <sub>25/50</sub><br>B <sub>25/85</sub> | (3375 K)<br>3435 K±1 % | (4330 K)<br>4390 K±1 % |
| 10 kΩ                       | ±1 % (F)<br>or<br>±2 % (G) |   |  | ERTJ1VG103□A           |                        |
| 100 kΩ                      |                            |   |  |                        | ERTJ1VS104□A           |

□ : Resistance Tolerance Code  
Avoid flow soldering.

### ■ Part Number List of Standard Type (Resistance Tolerance : ±5 %, ±3 %)

#### ● 0201(EIA)

| Nominal Resistance at 25 °C | Resistance Tolerance       | B value class code                      |  | G                      | P                      | T                      | V                      |
|-----------------------------|----------------------------|---|--|------------------------|------------------------|------------------------|------------------------|
|                             |                            | Nominal B value<br>*( ) Reference value | B <sub>25/50</sub><br>B <sub>25/85</sub> | (3375 K)<br>3435 K±2 % | 4050 K±3 %<br>(4100 K) | 4500 K±2 %<br>(4450 K) | 4700 K±2 %<br>(4750 K) |
| 2.0 kΩ                      | ±3 % (H)<br>or<br>±5 % (J) |   |  |                        |                        | ERTJZET202□            |                        |
| 3.0 kΩ                      |                            |   |  |                        |                        | ERTJZET302□            |                        |
| 4.7 kΩ                      |                            |   |  |                        |                        | ERTJZET472□            |                        |
| 10 kΩ                       |                            |   |  |                        | ERTJZEG103□A           |                        |                        |
| 47 kΩ                       |                            |   |  |                        |                        | ERTJZEP473□            |                        |
| 100 kΩ                      |                            |   |  |                        |                        |                        | ERTJZEV104□            |

□ : Resistance Tolerance Code  
Avoid flow soldering.

#### ● 0402(EIA)

| Nominal Resistance at 25 °C | Resistance Tolerance       | B value class code                      |  | A                      |                        |
|-----------------------------|----------------------------|---|--|------------------------|------------------------|
|                             |                            | Nominal B value<br>*( ) Reference value | B <sub>25/50</sub><br>B <sub>25/85</sub> | 2750 K±3 %<br>(2700 K) | 2800 K±3 %<br>(2750 K) |
| 22 Ω                        | ±3 % (H)<br>or<br>±5 % (J) |   |  | ERTJ0EA220□            |                        |
| 33 Ω                        |                            |   |  | ERTJ0EA330□            |                        |
| 40 Ω                        |                            |   |  | ERTJ0EA400□            |                        |
| 47 Ω                        |                            |   |  | ERTJ0EA470□            |                        |
| 68 Ω                        |                            |   |  |                        | ERTJ0EA680□            |
| 100 Ω                       |                            |   |  |                        | ERTJ0EA101□            |
| 150 Ω                       |                            |   |  | ERTJ0EA151□            |                        |

| Nominal Resistance at 25 °C | Resistance Tolerance       | B value class code                      |  | G                      | M                      | P                      | R                      |
|-----------------------------|----------------------------|---|--|------------------------|------------------------|------------------------|------------------------|
|                             |                            | Nominal B value<br>*( ) Reference value | B <sub>25/50</sub><br>B <sub>25/85</sub> | (3375 K)<br>3435 K±1 % | 3900 K±2 %<br>(3970 K) | 4050 K±2 %<br>(4100 K) | 4250 K±2 %<br>(4300 K) |
| 3.3 kΩ                      | ±3 % (H)<br>or<br>±5 % (J) |   |  |                        |                        |                        | ERTJ0ER332□            |
| 4.7 kΩ                      |                            |   |  |                        |                        |                        | ERTJ0ER472□            |
| 6.8 kΩ                      |                            |   |  |                        |                        |                        | ERTJ0ER682□            |
| 10 kΩ                       |                            |   |  | ERTJ0EG103□A           | ERTJ0EM103□            |                        | ERTJ0ER103□            |
| 15 kΩ                       |                            |   |  |                        |                        |                        | ERTJ0ER153□            |
| 22 kΩ                       |                            |   |  |                        |                        |                        | ERTJ0ER223□            |
| 33 kΩ                       |                            |   |  |                        |                        |                        | ERTJ0EP333□            |
| 47 kΩ                       |                            |   |  |                        |                        |                        | ERTJ0EP473□            |
| 100 kΩ                      |                            |   |  |                        |                        |                        | ERTJ0EP104□            |

| Nominal Resistance at 25 °C | Resistance Tolerance       | B value class code                      |  | S                      | T                              | V                      |
|-----------------------------|----------------------------|---|--|------------------------|--------------------------------|------------------------|
|                             |                            | Nominal B value<br>*( ) Reference value | B <sub>25/50</sub><br>B <sub>25/85</sub> | 4330 K±2 %<br>(4390 K) | 4500 K±2 %<br>(4450 K, 4580 K) | 4700 K±2 %<br>(4750 K) |
| 1.0 kΩ                      | ±3 % (H)<br>or<br>±5 % (J) |   |  |                        | ERTJ0ET102□                    |                        |
| 1.5 kΩ                      |                            |   |  |                        | ERTJ0ET152□                    |                        |
| 2.0 kΩ                      |                            |   |  |                        | ERTJ0ET202□                    |                        |
| 2.2 kΩ                      |                            |   |  |                        | ERTJ0ET222□                    |                        |
| 3.0 kΩ                      |                            |   |  |                        | ERTJ0ET302□                    |                        |
| 3.3 kΩ                      |                            |   |  |                        | ERTJ0ET332□                    |                        |
| 4.7 kΩ                      |                            |   |  |                        | ERTJ0ET472□                    |                        |
| 47 kΩ                       |                            |   |  |                        |                                | ERTJ0EV473□            |
| 68 kΩ                       |                            |   |  |                        |                                | ERTJ0EV683□            |
| 100 kΩ                      |                            |   |  | ERTJ0ES104□            | ERTJ0ET104□                    | ERTJ0EV104□            |
| 150 kΩ                      |                            |   |  |                        | ERTJ0ET154□                    | ERTJ0EV154□            |
| 220 kΩ                      |                            |   |  |                        |                                | ERTJ0EV224□            |
| 330 kΩ                      |                            |   |  |                        |                                | ERTJ0EV334□            |
| 470 kΩ                      |                            |   |  |                        |                                | ERTJ0EV474□            |

□ : Resistance Tolerance Code  
Avoid flow soldering.

Design and specifications are each subject to change without notice. Ask factory for the current technical specifications before purchase and/or use.  
Should a safety concern arise regarding this product, please be sure to contact us immediately.

● 0603(EIA)

| Nominal Resistance at 25 °C | Resistance Tolerance       | B value class code                      |  | A                      |                        | G                      | P                      |
|-----------------------------|----------------------------|---|--|------------------------|------------------------|------------------------|------------------------|
|                             |                            | Nominal B value<br>*( ) Reference value | B <sub>25/50</sub><br>B <sub>25/85</sub> | 2750 K±3 %<br>(2700 K) | 2800 K±3 %<br>(2750 K) | (3375 K)<br>3435 K±1 % | 4050 K±3 %<br>(4100 K) |
| 22 Ω                        | ±3 % (H)<br>or<br>±5 % (J) |   |  | ERTJ1VA220□            |                        |                        |                        |
| 33 Ω                        |                            |   |  | ERTJ1VA330□            |                        |                        |                        |
| 40 Ω                        |                            |   |  |                        | ERTJ1VA400□            |                        |                        |
| 47 Ω                        |                            |   |  |                        | ERTJ1VA470□            |                        |                        |
| 68 Ω                        |                            |   |  |                        | ERTJ1VA680□            |                        |                        |
| 100 Ω                       |                            |   |  |                        | ERTJ1VA101□            |                        |                        |
| 10 kΩ                       |                            |   |  |                        |                        | ERTJ1VG103□A           |                        |
| 47 kΩ                       |                            |   |  |                        |                        |                        | ERTJ1VP473□            |

| Nominal Resistance at 25 °C | Resistance Tolerance       | B value class code                      |  | R                      | S                      | T                      | V                      |
|-----------------------------|----------------------------|---|--|------------------------|------------------------|------------------------|------------------------|
|                             |                            | Nominal B value<br>*( ) Reference value | B <sub>25/50</sub><br>B <sub>25/85</sub> | 4250 K±2 %<br>(4300 K) | (4330 K)<br>4390 K±1 % | 4500 K±2 %<br>(4450 K) | 4700 K±2 %<br>(4750 K) |
| 1.0 kΩ                      | ±3 % (H)<br>or<br>±5 % (J) |   |  |                        |                        | ERTJ1VT102□            |                        |
| 1.5 kΩ                      |                            |   |  |                        |                        | ERTJ1VT152□            |                        |
| 2.0 kΩ                      |                            |   |  |                        |                        | ERTJ1VT202□            |                        |
| 2.2 kΩ                      |                            |   |  |                        |                        | ERTJ1VT222□            |                        |
| 3.0 kΩ                      |                            |   |  |                        |                        | ERTJ1VT302□            |                        |
| 3.3 kΩ                      |                            |   |  |                        | ERTJ1VR332□            |                        | ERTJ1VT332□            |
| 4.7 kΩ                      |                            |   |  |                        | ERTJ1VR472□            |                        | ERTJ1VT472□            |
| 6.8 kΩ                      |                            |   |  |                        | ERTJ1VR682□            |                        |                        |
| 10 kΩ                       |                            |   |  |                        | ERTJ1VR103□            |                        |                        |
| 15 kΩ                       |                            |   |  |                        | ERTJ1VR153□            |                        |                        |
| 22 kΩ                       |                            |   |  |                        | ERTJ1VR223□            |                        |                        |
| 33 kΩ                       |                            |   |  |                        | ERTJ1VR333□            |                        |                        |
| 47 kΩ                       |                            |   |  |                        | ERTJ1VR473□            |                        | ERTJ1VV473□            |
| 68 kΩ                       |                            |   |  |                        | ERTJ1VR683□            |                        | ERTJ1VV683□            |
| 100 kΩ                      |                            |   |  |                        |                        | ERTJ1VS104□A           | ERTJ1VV104□            |
| 150 kΩ                      |                            |   |  |                        |                        |                        | ERTJ1VV154□            |

□ : Resistance Tolerance Code  
Avoid flow soldering.

- Typical Application
- Temperature Detection

### Writing current control of HDD

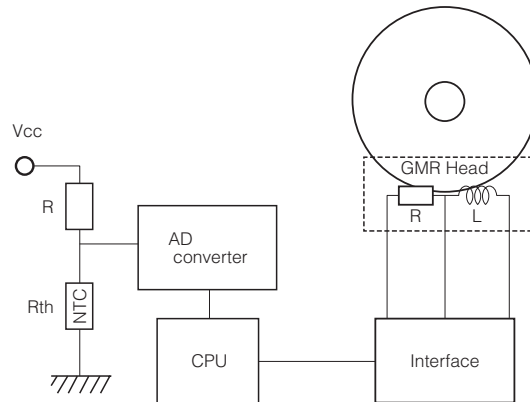

- Temperature Compensation (Pseudo-linearization)

### Contrast level control of LCD

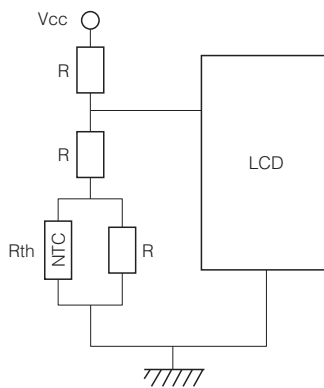

- Temperature Compensation (RF circuit)

### Temperature compensation of TCXO

