

# NTC Thermistors



**muRata** *Innovator  
in Electronics*  
Murata  
Manufacturing Co., Ltd.

Cat.No.R44E-12

**for EU RoHS Compliant**

- All the products in this catalog comply with EU RoHS.
- EU RoHS is "the European Directive 2002/95/EC on the Restriction of the Use of Certain Hazardous Substances in Electrical and Electronic Equipment".
- For more details, please refer to our website 'Murata's Approach for EU RoHS' (<http://www.murata.com/info/rohs.html>).

# CONTENTS

1

<b>Part Numbering</b>	2
<b>Basic Characteristics</b>	6
<b>1</b> for Temperature Sensor and Compensation 0201 (0603) Size	7
<b>2</b> for Temperature Sensor and Compensation 0402 (1005) Size	8
<b>3</b> for Temperature Sensor and Compensation 0603 (1608) Size	10
<b>4</b> for Temperature Sensor and Compensation 0805 (2012) Size	12
for Temp. Sensor and Compensation Chip Type Standard Land Pattern Dimensions	13
for Temp. Sensor and Compensation Chip Type Temperature Characteristics (Center Value)	14
for Temp. Sensor and Compensation Chip Type △Caution/Notice	18
for Temp. Sensor and Compensation Chip Type Package	22
<b>5</b> for Temperature Sensor Thermo String Type	25
● for Temperature Sensor Thermo String Type Specifications and Test Methods	26
<b>6</b> for Temperature Sensor Lead Type	28
<b>7</b> for Temperature Sensor Lead Insulation Type	29
for Temperature Sensor Temperature Characteristics (Center Value)	31
for Temperature Sensor Thermo String Type/Lead Type △Caution/Notice	32
for Temperature Sensor Thermo String Type/Lead Type Package	34
<b>8</b> for Inrush Current Suppression Lead Type	35
● Current - R Ratio (RT/R25)/Current - Temperature Characteristics (Typical)	37
● for Inrush Current Suppression Lead Type △Caution/Notice	41
● for Inrush Current Suppression Lead Type Package	43

2

3

4

5

6

7

8

## ● Part Numbering

### NTC Thermistors for Temp. Sensor and Compensation Chip Type

(Part Number) 

NC	P	18	XH	103	J	03	RB
①	②	③	④	⑤	⑥	⑦	⑧

#### ① Product ID

Product ID	
<b>NC</b>	NTC Thermistors Chip Type

#### ② Series

Code	Series
<b>P</b>	Plated Termination Series

#### ③ Dimensions (L×W)

Code	Dimensions (L×W)	EIA
<b>03</b>	0.60×0.30mm	0201
<b>15</b>	1.00×0.50mm	0402
<b>18</b>	1.60×0.80mm	0603
<b>21</b>	2.00×1.25mm	0805

#### ④ Temperature Characteristics

Code	Temperature Characteristics
<b>WB</b>	Nominal B-Constant 4050—4099K
<b>WD</b>	Nominal B-Constant 4150—4199K
<b>WF</b>	Nominal B-Constant 4250—4299K
<b>WL</b>	Nominal B-Constant 4450—4499K
<b>WM</b>	Nominal B-Constant 4500—4549K
<b>XC</b>	Nominal B-Constant 3100—3149K
<b>XF</b>	Nominal B-Constant 3250—3299K
<b>XH</b>	Nominal B-Constant 3350—3399K
<b>XM</b>	Nominal B-Constant 3500—3549K
<b>XQ</b>	Nominal B-Constant 3650—3699K
<b>XV</b>	Nominal B-Constant 3900—3949K
<b>XW</b>	Nominal B-Constant 3950—3999K

#### ⑤ Resistance

Expressed by three-digit alphanumerics. The unit is ohm ( $\Omega$ ). The first and second figures are significant digits, and the third figure expresses the number of zeros which follow the two figures. If there is a decimal point, it is expressed by the capital letter "R". In this case, all figures are significant digits.

Ex. 

Code	Resistance
<b>102</b>	1k $\Omega$
<b>103</b>	10k $\Omega$
<b>104</b>	100k $\Omega$

#### ⑥ Resistance Tolerance

Code	Resistance Tolerance
<b>D</b>	±0.5%
<b>E</b>	±3%
<b>F</b>	±1%
<b>J</b>	±5%

#### ⑦ Individual Specifications

Structures and others are expressed by two figures.

Code	Individual Specifications
<b>03</b>	Standard Type

Please contact us for details.

#### ⑧ Packaging

Code	Packaging
<b>RA</b>	Plastic Taping 4mm Pitch
<b>RB</b>	Paper Taping 4mm Pitch
<b>RC</b>	Paper Taping 2mm Pitch (10000 pcs.)
<b>RL</b>	Paper Taping 2mm Pitch (15000 pcs.)

## NTC Thermistor for Temperature Sensor Thermo String Type

(Part Number)

<b>NXF</b>	<b>T</b>	<b>15</b>	<b>XH</b>	<b>103</b>	<b>F</b>	<b>A</b>	<b>2</b>	<b>B</b>	<b>025</b>
①	②	③	④	⑤	⑥	⑦	⑧	⑨	⑩

### ① Product ID

Product ID	
<b>NXF</b>	NTC Thermistors Sensor Thermo String Type

### ② Individual Specifications

Code	Individual Specifications
<b>T</b>	Commercial Type

### ③ Chip Dimensions

Code	Dimensions (LxT)	EIA
<b>15</b>	1.00 x 0.50mm	0402

### ④ Temperature Characteristics

Code	Temperature Characteristics
<b>WB</b>	Nominal B-Constant 4050-4099K
<b>WF</b>	Nominal B-Constant 4250-4299K
<b>XH</b>	Nominal B-Constant 3350-3399K

### ⑤ Resistance

Expressed by three figures. The unit is ( $\Omega$ ). The first and second figures are significant digits, and the third figure expresses the number of zeros which follow the two figures.

Ex.

Code	Resistance
<b>103</b>	10k $\Omega$
<b>473</b>	47k $\Omega$
<b>104</b>	100k $\Omega$

### ⑥ Resistance Tolerance

Code	Resistance Tolerance
<b>F</b>	$\pm 1\%$

### ⑦ Lead Wire Type

Code	Lead Wire Type
<b>A</b>	$\varnothing 0.3$ Copper Lead Wire with Polyurethane Coat

### ⑧ Shape of the Lead Wire Kink

Code	Shape of the Lead Wire Kink
<b>1</b>	The Twist of Lead Wire Type
<b>2</b>	Standard Type

### ⑨ Packaging

Code	Packaging
<b>B</b>	Bulk

### ⑩ Dimensions (Full Length)

Code	Dimensions (Full Length)
<b>025</b>	25mm
<b>030</b>	30mm
<b>040</b>	40mm
<b>050</b>	50mm
<b>060</b>	60mm
<b>070</b>	70mm
<b>080</b>	80mm
<b>090</b>	90mm
<b>100</b>	100mm
<b>110</b>	110mm
<b>120</b>	120mm
<b>130</b>	130mm
<b>140</b>	140mm
<b>150</b>	150mm

## NTC Thermistors for Temperature Sensor Lead Type

(Part Number)

<b>NT</b>	<b>SA0</b>	<b>XH</b>	<b>103</b>	<b>F</b>	<b>E1</b>	<b>B0</b>
①	②	③	④	⑤	⑥	⑦

### ① Product ID

Product ID	
<b>NT</b>	NTC Thermistors

### ② Series

Code	Series
<b>SA0</b>	for Temperature Sensors No Lead-coating Type
<b>SD0</b>	for Temperature Sensors Lead-coating Type (Total Length 30mm max.)
<b>SD1</b>	for Temperature Sensors Lead-coating Type (Total Length 30 to 50mm)

### ③ Temperature Characteristics

Code	Temperature Characteristics
<b>WB</b>	Nominal B-Constant 4050–4099K
<b>WC</b>	Nominal B-Constant 4100–4149K
<b>WD</b>	Nominal B-Constant 4150–4199K
<b>WF</b>	Nominal B-Constant 4250–4299K
<b>XH</b>	Nominal B-Constant 3350–3399K
<b>XM</b>	Nominal B-Constant 3500–3549K
<b>XR</b>	Nominal B-Constant 3700–3749K
<b>XV</b>	Nominal B-Constant 3900–3949K

### ④ Resistance

Expressed by three-digit alphanumerics. The unit is ohm ( $\Omega$ ). The first and second figures are significant digits, and the third figure expresses the number of zeros which follow the two figures. If there is a decimal point, it is expressed by the capital letter "R". In this case, all figures are significant digits.

Ex.

Code	Resistance
<b>202</b>	2k $\Omega$
<b>203</b>	20k $\Omega$

### ⑤ Resistance Tolerance

Code	Resistance Tolerance
<b>E</b>	$\pm 3\%$
<b>F</b>	$\pm 1\%$

### ⑥ Individual Specifications

A lead structure and other specifications are expressed by two digits.

Code	Individual Specifications
<b>E1</b>	Standard Bulk ( <b>NTSA</b> , <b>NTSD0</b> Series)
<b>N6</b>	Standard Ammo Pack Taping ( <b>NTSA</b> Series)
<b>PB</b>	Standard Bulk ( <b>NTSD1</b> Series)

### ⑦ Packaging (NTSA/NTSD0 Series)

Code	Packaging
<b>A0</b>	Ammo Pack Taping
<b>B0</b>	Bulk

### ⑦ Total Length (NTSD1 Series)

Code	Total Length
<b>30</b>	30mm
<b>40</b>	40mm
<b>50</b>	50mm

## NTC Thermistors for Inrush Current Suppression Lead Type

(Part Number)

<b>NT</b>	<b>PA7</b>	<b>160</b>	<b>L</b>	<b>BM</b>	<b>B0</b>
①	②	③	④	⑤	⑥

### ① Product ID

Product ID	
<b>NT</b>	NTC Thermistors

### ② Series

Code	Series	Nominal Body Diameter
<b>PA7</b>	Inrush Current Suppression Lead Type	ø7mm
<b>PA9</b>		ø9mm
<b>PAA</b>		ø10mm
<b>PAD</b>		ø13mm
<b>PAJ</b>		ø18mm
<b>PAN</b>		ø22mm

### ③ Resistance

Expressed by three-digit alphanumerics. The unit is ohm ( $\Omega$ ). The first and second figures are significant digits, and the third figure expresses the number of zeros which follow the two figures. If there is a decimal point, it is expressed by the capital letter "R". In this case, all figures are significant digits.

Ex.

Code	Resistance
<b>3R0</b>	3 $\Omega$
<b>100</b>	10 $\Omega$

### ④ Resistance Tolerance

Code	Resistance Tolerance
<b>L</b>	$\pm 15\%$

### ⑤ Individual Specifications

A lead structure and other specifications are expressed by two capital letters.

Code	Individual Specifications	Body Diameter
<b>B1</b>	Standard Type (Ammo Pack)	ø7mm, ø9mm
<b>BM</b>	Standard Type (Bulk)	ø7mm, ø9mm
<b>D6</b>	Standard Type (Ammo Pack)	ø10mm, ø13mm
<b>DK</b>	Standard (Bulk)	ø18mm, ø22mm
<b>DN</b>	Standard (Bulk)	ø10mm, ø13mm

### ⑥ Packaging

Code	Packaging
<b>A0</b>	Ammo Pack Taping
<b>B0</b>	Bulk

# Basic Characteristics

## Basic Characteristics

### 1. Zero-power Resistance of Thermistor: R

$$R = R_0 \exp B (1/T - 1/T_0) \dots\dots\dots(1)$$

R: Resistance in ambient temperature T (K)  
(K: absolute temperature)

R<sub>0</sub>: Resistance in ambient temperature T<sub>0</sub> (K)

B: B-Constant of Thermistor

### 2. B-Constant

as (1) formula

$$B = \frac{\ln (R/R_0)}{1/T - 1/T_0} \dots\dots\dots(2)$$

### 3. Thermal Dissipation Constant

When electric power P (mW) is spent in ambient temperature T<sub>1</sub> and thermistor temperature rises T<sub>2</sub>, there is a formula as follows

$$P = C (T_2 - T_1) \dots\dots\dots(3)$$

C: Thermal dissipation constant (mW/°C)

Thermal dissipation constant is varied with dimensions, measurement conditions, etc.

### 4. Thermal Time Constant

Period in which Thermistor's temperature will change 63.2% of its temperature difference from ambient temperature T<sub>0</sub> (°C) to T<sub>1</sub> (°C).

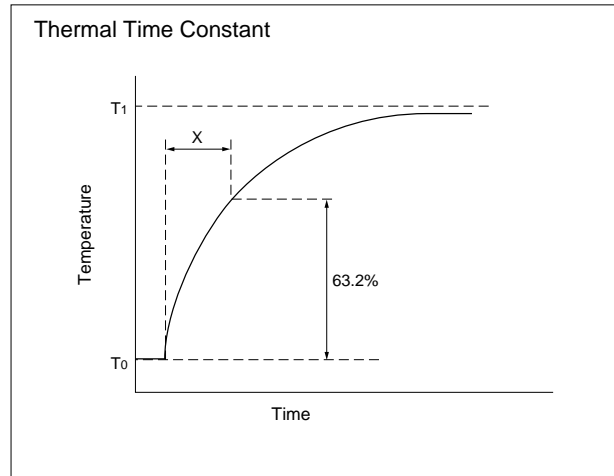
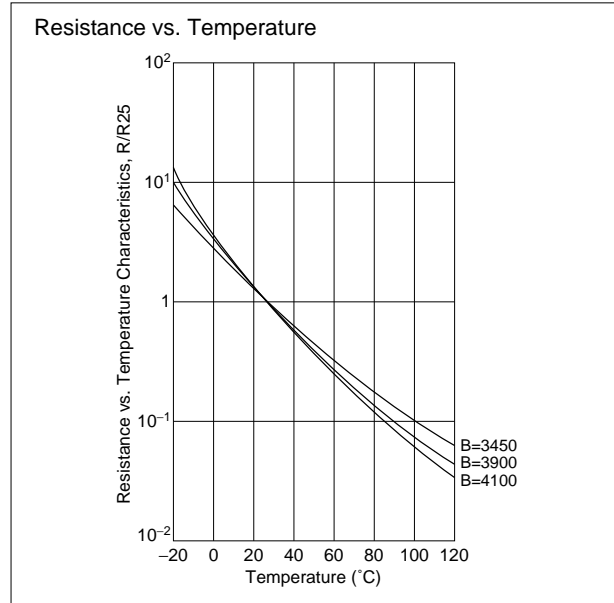

## Performance

Item	Condition
Resistance	Measured by zero-power in specified ambient temperature.
B-Constant	Calculated between two specified ambient temperatures by next formula. T and T <sub>0</sub> is absolute temperature (K). $B = \frac{\ln (R/R_0)}{1/T - 1/T_0}$
Thermal Dissipation Constant	Shows necessary electric power that Thermistor's temperature rises 1°C by self heating. It is calculated by next formula. (mW/°C) $C = \frac{P}{T - T_0}$
Rated Electric Power	Shows necessary electric power that Thermistor's temperature rises to a specified temperature by self heating in ambient temperature 25°C.
Permissive Operating Current	It is possible to keep Thermistor's temperature rising max. 1°C.

Please inquire about test conditions and ratings.



# NTC Thermistors



## for Temperature Sensor and Compensation 0201 (0603) Size

0201/0402/0603/0805 sized Chip NTC Thermistors have Ni barrier termination and provide excellent solderability and offer high stability in environment by unique inner construction.

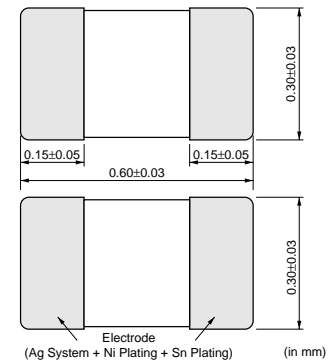

### ■ Features

1. Excellent solderability and high stability in environment
2. Excellent long time aging stability
3. High accuracy in resistance and B-Constant
4. Reflow soldering possible
5. NCP series are recognized by UL/cUL.  
(UL1434, File No.E137188)

### ■ Applications

1. Temperature compensation for transistor, IC and crystal oscillator in mobile communications
2. Temperature sensor for rechargeable batteries
3. Temperature compensation of LCD
4. Temperature compensation in general use of electric circuits

Part Number	Resistance (25°C) (ohm)	B-Constant (25-50°C) (K)	B-Constant (25-80°C) (Reference Value) (K)	B-Constant (25-85°C) (Reference Value) (K)	B-Constant (25-100°C) (Reference Value) (K)	Permissible Operating Current (25°C) (mA)	Rated Electric Power (25°C) (mW)	Typical Dissipation Constant (25°C) (mW/°C)
NCP03YS110J05RL	11 ±5%	2750 ±3%	2758	2758	2758	9.50	100	1
NCP03YS220J05RL	22 ±5%	2750 ±3%	2758	2758	2758	6.70	100	1
NCP03YS330J05RL	33 ±5%	2750 ±3%	2758	2758	2758	5.50	100	1
NCP03YS470J05RL	47 ±5%	2750 ±3%	2758	2758	2758	4.60	100	1
NCP03YS680J05RL	68 ±5%	2750 ±3%	2758	2758	2758	3.80	100	1
NCP03YS101J05RL	100 ±5%	2750 ±3%	2758	2758	2758	3.10	100	1
NCP03XM102□05RL	1.0k	3500 ±1%	3539	3545	3560	1.00	100	1
NCP03XM152□05RL	1.5k	3500 ±1%	3539	3545	3560	0.81	100	1
NCP03XM222□05RL	2.2k	3500 ±1%	3539	3545	3560	0.67	100	1
NCP03XM332□05RL	3.3k	3500 ±1%	3539	3545	3560	0.55	100	1
NCP03XM472□05RL	4.7k	3500 ±1%	3539	3545	3560	0.46	100	1
NCP03XH682□05RL	6.8k	3380 ±1%	3428	3434	3455	0.38	100	1
NCP03XH103F05RL	10k ±1%	3380 ±1%	3428	3434	3455	0.31	100	1
NCP03XH103□05RL	10k	3380 ±1%	3428	3434	3455	0.31	100	1
NCP03XV103□05RL	10k	3900 ±1%	3930	3934	3944	0.31	100	1
NCP03XH153□05RL	15k	3380 ±1%	3428	3434	3455	0.25	100	1
NCP03XH223□05RL	22k	3380 ±1%	3428	3434	3455	0.21	100	1
NCP03WF333□05RL	33k	4250 ±1%	4303	4311	4334	0.17	100	1
NCP03WB473□05RL	47k	4050 ±3%	4101	4108	4131	0.14	100	1
NCP03WL473□05RL	47k	4485 ±1%	4537	4543	4557	0.14	100	1
NCP03WF683□05RL	68k	4250 ±1%	4303	4311	4334	0.12	100	1
NCP03WL683□05RL	68k	4485 ±1%	4537	4543	4557	0.12	100	1
NCP03WF104F05RL	100k ±1%	4250 ±1%	4303	4311	4334	0.10	100	1
NCP03WF104□05RL	100k	4250 ±1%	4303	4311	4334	0.10	100	1
NCP03WL104□05RL	100k	4485 ±1%	4537	4543	4557	0.10	100	1
NCP03WL154□05RL	150k	4485 ±1%	4537	4543	4557	0.08	100	1
NCP03WL224□05RL	220k	4485 ±1%	4537	4543	4557	0.06	100	1

A blank column is filled with resistance tolerance codes (E: ±3%, J: ±5%).

Rated Electric Power is necessary electric power that Thermistor's temperature rises 100°C by self heating at 25°C in still air.

Operating Temperature Range: -40°C to +125°C

# NTC Thermistors



## for Temperature Sensor and Compensation 0402 (1005) Size

2

0201/0402/0603/0805 sized Chip NTC Thermistor have Ni barrier termination and provide excellent solderability and offer high stability in environment by unique inner construction.

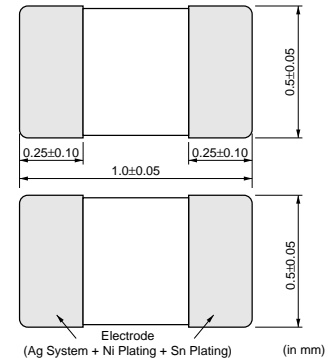

### ■ Features

1. Excellent solderability and high stability in environment
2. Excellent long time aging stability
3. High accuracy in resistance and B-Constant
4. Reflow soldering possible
5. Same B-constant in the same resistance in the three sizes (0805 size / 0603 size / 0402 size)  
Easy to use smaller size in the circuits
6. NCP series are recognized by UL/cUL.  
(UL1434, File No.E137188)

### ■ Applications

1. Temperature compensation for transistor, IC and crystal oscillator in mobile communications
2. Temperature sensor for rechargeable batteries
3. Temperature compensation of LCD
4. Temperature compensation in general use of electric circuits

Part Number	Resistance (25°C) (ohm)	B-Constant (25-50°C) (K)	B-Constant (25-80°C) (Reference Value) (K)	B-Constant (25-85°C) (Reference Value) (K)	B-Constant (25-100°C) (Reference Value) (K)	Permissible Operating Current (25°C) (mA)	Rated Electric Power (25°C) (mW)	Typical Dissipation Constant (25°C) (mW/°C)
NCP15XC220□03RC	22	3100 ±3%	3126	3128	3136	6.70	100	1
NCP15XC330□03RC	33	3100 ±3%	3126	3128	3136	5.50	100	1
NCP15XC470□03RC	47	3100 ±3%	3126	3128	3136	4.60	100	1
NCP15XC680□03RC	68	3100 ±3%	3126	3128	3136	3.80	100	1
NCP15XF101□03RC	100	3250 ±3%	3282	3284	3296	3.10	100	1
NCP15XF151□03RC	150	3250 ±3%	3282	3284	3296	2.50	100	1
NCP15XM221□03RC	220	3500 ±3%	3539	3545	3560	2.10	100	1
NCP15XM331□03RC	330	3500 ±3%	3539	3545	3560	1.70	100	1
NCP15XQ471□03RC	470	3650 ±2%	3688	3693	3706	1.40	100	1
NCP15XQ681□03RC	680	3650 ±3%	3688	3693	3706	1.20	100	1
NCP15XQ102□03RC	1.0k	3650 ±2%	3688	3693	3706	1.00	100	1
NCP15XW152□03RC	1.5k	3950 ±3%	3982	3987	3998	0.81	100	1
NCP15XW222□03RC	2.2k	3950 ±3%	3982	3987	3998	0.67	100	1
NCP15XW332□03RC	3.3k	3950 ±3%	3982	3987	3998	0.55	100	1
NCP15XW472□03RC	4.7k	3500 ±2%	3539	3545	3560	0.46	100	1
NCP15XW682□03RC	6.8k	3950 ±3%	3982	3987	3998	0.38	100	1
NCP15XH103D03RC	10k ±0.5%	3380 ±0.7%	3428	3434	3455	0.31	100	1
NCP15XH103F03RC	10k ±1%	3380 ±1%	3428	3434	3455	0.31	100	1
NCP15XH103□03RC	10k	3380 ±1%	3428	3434	3455	0.31	100	1
NCP15XV103□03RC	10k	3900 ±3%	3930	3934	3944	0.31	100	1
NCP15XW153□03RC	15k	3950 ±3%	3982	3987	3998	0.25	100	1
NCP15XW223□03RC	22k	3950 ±3%	3982	3987	3998	0.21	100	1
NCP15WL223□03RC	22k	4485 ±1%	4537	4543	4557	0.21	100	1
NCP15WB333□03RC	33k	4050 ±3%	4101	4108	4131	0.17	100	1
NCP15WL333□03RC	33k	4485 ±1%	4537	4543	4557	0.17	100	1

Continued on the following page. ↗

Continued from the preceding page.

Part Number	Resistance (25°C) (ohm)	B-Constant (25-50°C) (K)	B-Constant (25-80°C) (Reference Value) (K)	B-Constant (25-85°C) (Reference Value) (K)	B-Constant (25-100°C) (Reference Value) (K)	Permissive Operating Current (25°C) (mA)	Rated Electric Power (25°C) (mW)	Typical Dissipation Constant (25°C) (mW/°C)
<b>NCP15WB473D03RC</b>	47k ±0.5%	4050 ±0.5%	4101	4108	4131	0.14	100	1
<b>NCP15WB473F03RC</b>	47k ±1%	4050 ±1%	4101	4108	4131	0.14	100	1
<b>NCP15WB473□03RC</b>	47k	4050 ±1%	4101	4108	4131	0.14	100	1
<b>NCP15WL473□03RC</b>	47k	4485 ±1%	4537	4543	4557	0.14	100	1
<b>NCP15WD683□03RC</b>	68k	4150 ±3%	4201	4209	4232	0.12	100	1
<b>NCP15WL683□03RC</b>	68k	4485 ±1%	4537	4543	4557	0.12	100	1
<b>NCP15WF104D03RC</b>	100k ±0.5%	4250 ±0.5%	4303	4311	4334	0.10	100	1
<b>NCP15WF104F03RC</b>	100k ±1%	4250 ±1%	4303	4311	4334	0.10	100	1
<b>NCP15WF104□03RC</b>	100k	4250 ±1%	4303	4311	4334	0.10	100	1
<b>NCP15WL104□03RC</b>	100k	4485 ±1%	4537	4543	4557	0.10	100	1
<b>NCP15WL154□03RC</b>	150k	4485 ±1%	4537	4543	4557	0.08	100	1
<b>NCP15WM154□03RC</b>	150k	4500 ±3%	4571	4582	4614	0.08	100	1
<b>NCP15WM224□03RC</b>	220k	4500 ±3%	4571	4582	4614	0.06	100	1
<b>NCP15WM474□03RC</b>	470k	4500 ±3%	4571	4582	4614	0.04	100	1

A blank column is filled with resistance tolerance codes (E: ±3%, J: ±5%).

Rated Electric Power is necessary electric power that Thermistor's temperature rises 100°C by self heating at 25°C in still air.

Operating Temperature Range: -40°C to +125°C

# NTC Thermistors



## for Temperature Sensor and Compensation 0603 (1608) Size

0201/0402/0603/0805 sized Chip NTC Thermistors have Ni barrier termination and provide excellent solderability and offer high stability in environment by unique inner construction.

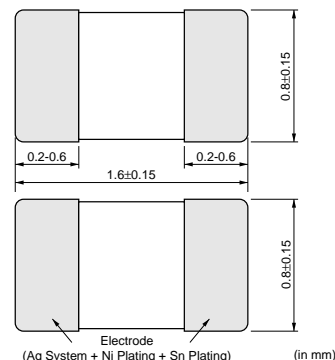

3

### ■ Features

1. Excellent solderability and high stability in environment
2. Excellent long time aging stability
3. High accuracy in resistance and B-constant
4. Flow / Reflow soldering possible
5. Same B-Constant in the same resistance in the three sizes (0805 size / 0603 size / 0402 size)  
Easy to use smaller size in the circuits
6. NCP series are recognized by UL/cUL.  
(UL1434, File No.E137188)

### ■ Applications

1. Temperature compensation for transistor, IC and crystal oscillator in mobile communications
2. Temperature sensor for rechargeable batteries
3. Temperature compensation of LCD
4. Temperature compensation in general use of electric circuits

Part Number	Resistance (25°C) (ohm)	B-Constant (25-50°C) (K)	B-Constant (25-80°C) (Reference Value) (K)	B-Constant (25-85°C) (Reference Value) (K)	B-Constant (25-100°C) (Reference Value) (K)	Permissible Operating Current (25°C) (mA)	Rated Electric Power (25°C) (mW)	Typical Dissipation Constant (25°C) (mW/°C)
NCP18XF101□03RB	100	3250 ±3%	3282	3284	3296	3.10	100	1
NCP18XF151□03RB	150	3250 ±3%	3282	3284	3296	2.50	100	1
NCP18XM221□03RB	220	3500 ±3%	3539	3545	3560	2.10	100	1
NCP18XM331□03RB	330	3500 ±3%	3539	3545	3560	1.70	100	1
NCP18XQ471□03RB	470	3650 ±2%	3688	3693	3706	1.40	100	1
NCP18XQ681□03RB	680	3650 ±3%	3688	3693	3706	1.20	100	1
NCP18XQ102□03RB	1.0k	3650 ±2%	3688	3693	3706	1.00	100	1
NCP18XW152□03RB	1.5k	3950 ±3%	3982	3987	3998	0.81	100	1
NCP18XW222□03RB	2.2k	3950 ±3%	3982	3987	3998	0.67	100	1
NCP18XW332□03RB	3.3k	3950 ±3%	3982	3987	3998	0.55	100	1
NCP18XM472□03RB	4.7k	3500 ±2%	3539	3545	3560	0.46	100	1
NCP18XW682□03RB	6.8k	3950 ±3%	3982	3987	3998	0.38	100	1
NCP18XH103D03RB	10k ±0.5%	3380 ±0.7%	3428	3434	3455	0.31	100	1
NCP18XH103F03RB	10k ±1%	3380 ±1%	3428	3434	3455	0.31	100	1
NCP18XH103□03RB	10k	3380 ±1%	3428	3434	3455	0.31	100	1
NCP18XV103□03RB	10k	3900 ±3%	3930	3934	3944	0.31	100	1
NCP18XW153□03RB	15k	3950 ±3%	3982	3987	3998	0.25	100	1
NCP18XW223□03RB	22k	3950 ±3%	3982	3987	3998	0.21	100	1
NCP18WB333□03RB	33k	4050 ±3%	4101	4108	4131	0.17	100	1
NCP18WB473D03RB	47k ±0.5%	4030 ±0.5%	4101	4108	4131	0.14	100	1
NCP18WB473F10RB	47k ±1%	4050 ±1.5%	4101	4108	4131	0.14	100	1
NCP18WB473□03RB	47k	4050 ±2%	4101	4108	4131	0.14	100	1
NCP18WD683□03RB	68k	4150 ±3%	4201	4209	4232	0.12	100	1
NCP18WF104D03RB	100k ±0.5%	4200 ±0.5%	4255	4260	4282	0.10	100	1
NCP18WF104F12RB	100k ±1%	4200 ±1%	4255	4260	4282	0.10	100	1

Continued on the following page. ↗

Continued from the preceding page.

Part Number	Resistance (25°C) (ohm)	B-Constant (25-50°C) (K)	B-Constant (25-80°C) (Reference Value) (K)	B-Constant (25-85°C) (Reference Value) (K)	B-Constant (25-100°C) (Reference Value) (K)	Permissible Operating Current (25°C) (mA)	Rated Electric Power (25°C) (mW)	Typical Dissipation Constant (25°C) (mW/°C)
<b>NCP18WF104□03RB</b>	100k	4250 ±2%	4255	4260	4282	0.10	100	1
<b>NCP18WM154□03RB</b>	150k	4500 ±3%	4571	4582	4614	0.08	100	1
<b>NCP18WM224□03RB</b>	220k	4500 ±3%	4571	4582	4614	0.06	100	1
<b>NCP18WM474□03RB</b>	470k	4500 ±3%	4571	4582	4614	0.04	100	1

A blank column is filled with resistance tolerance codes (E: ±3%, J: ±5%).

Rated Electric Power is necessary electric power that Thermistor's temperature rises 100°C by self heating at 25°C in still air.

Operating Temperature Range: -40°C to +125°C

# NTC Thermistors



## for Temperature Sensor and Compensation 0805 (2012) Size

0201/0402/0603/0805 sized Chip NTC Thermistors have Ni barrier termination and provide excellent solderability and offer high stability in environment by unique inner construction.

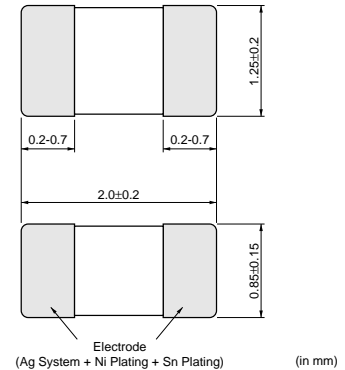

### ■ Features

1. Excellent solderability and high stability in environment
2. Excellent long time aging stability
3. High accuracy in resistance and B-constant
4. Flow / Reflow soldering possible
5. Same B-Constant in the same resistance in the three sizes (0805 size / 0603 size / 0402 size)  
Easy to use smaller size in the circuits
6. NCP series are recognized by UL/cUL.  
(UL1434, File No.E137188)

4

### ■ Applications

1. Temperature compensation for transistor, IC and crystal oscillator in mobile communications
2. Temperature sensor for rechargeable batteries
3. Temperature compensation of LCD
4. Temperature compensation in general use of electric circuits

Part Number	Resistance (25°C) (ohm)	B-Constant (25-50°C) (K)	B-Constant (25-80°C) (Reference Value) (K)	B-Constant (25-85°C) (Reference Value) (K)	B-Constant (25-100°C) (Reference Value) (K)	Permissible Operating Current (25°C) (mA)	Rated Electric Power (25°C) (mW)	Typical Dissipation Constant (25°C) (mW/°C)
NCP21XM221J03RA	220 ±5%	3500 ±3%	3539	3545	3560	3.00	200	2
NCP21XQ471J03RA	470 ±5%	3650 ±3%	3688	3693	3706	2.00	200	2
NCP21XQ102J03RA	1.0k ±5%	3650 ±3%	3688	3693	3706	1.40	200	2
NCP21XW222J03RA	2.2k ±5%	3950 ±3%	3982	3987	3998	0.90	200	2
NCP21XM472J03RA	4.7k ±5%	3500 ±3%	3539	3545	3560	0.65	200	2
NCP21XV103J03RA	10k ±5%	3900 ±3%	3930	3934	3944	0.44	200	2
NCP21XW153J03RA	15k ±5%	3950 ±3%	3982	3987	3998	0.36	200	2
NCP21XW223J03RA	22k ±5%	3950 ±3%	3982	3987	3998	0.30	200	2
NCP21WB333J03RA	33k ±5%	4050 ±3%	4101	4108	4131	0.24	200	2
NCP21WB473J03RA	47k ±5%	4050 ±3%	4101	4108	4131	0.20	200	2
NCP21WF104J03RA	100k ±5%	4250 ±3%	4303	4311	4334	0.14	200	2

Rated Electric Power is necessary electric power that Thermistor's temperature rises 100°C by self heating at 25°C in still air.  
 Operating Temperature Range: -40°C to +125°C

## for Temp. Sensor and Compensation Chip Type Standard Land Pattern Dimensions

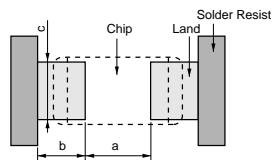

Part Number	Soldering Methods	Dimensions (mm)			
		Chip (LxW)	a	b	c
<b>NCP03</b>	Reflow Soldering	0.6x0.3	0.25	0.25	0.3
<b>NCP15</b>	Reflow Soldering	1.0x0.5	0.4	0.4-0.5	0.5
<b>NCP18</b>	Flow Soldering	1.6x0.8	0.6-1.0	0.8-0.9	0.6-0.8
	Reflow Soldering		0.6-0.8	0.6-0.7	0.6-0.8
<b>NCP21</b>	Flow Soldering	2.0x1.25	1.0-1.1	0.9-1.0	1.0-1.2
	Reflow Soldering		1.0-1.1	0.6-0.7	1.0-1.2

## for Temp. Sensor and Compensation Chip Type Temperature Characteristics (Center Value)

Part Number	NCP□□YS110	NCP□□YS220	NCP□□XC220	NCP□□YS330	NCP□□XC330	NCP□□YS470	NCP□□XC470	NCP□□YS680
Resistance	11Ω	22Ω	22Ω	33Ω	33Ω	47Ω	47Ω	68Ω
B-Constant	2750K	2750K	3100K	2750K	3100K	2750K	3100K	2750K
Temp. (°C)	Resistance (Ω)	Resistance (Ω)	Resistance (Ω)	Resistance (Ω)	Resistance (Ω)	Resistance (Ω)	Resistance (Ω)	Resistance (Ω)
-40	127.366	254.732	355.823	382.098	533.734	544.201	760.166	787.354
-35	101.662	203.325	273.975	304.987	410.962	434.376	585.310	628.459
-30	81.726	163.452	213.003	245.178	319.504	349.193	455.051	505.215
-25	66.148	132.296	166.943	198.444	250.415	282.633	356.652	408.915
-20	53.946	107.893	131.997	161.839	197.996	230.498	281.994	333.487
-15	44.273	88.546	105.318	132.819	157.978	189.167	224.998	273.688
-10	36.494	72.987	84.670	109.481	127.005	155.927	180.886	225.597
-5	30.262	60.523	68.628	90.785	102.942	129.299	146.614	187.071
0	25.226	50.451	55.981	75.677	83.972	107.782	119.596	155.940
5	21.150	42.300	45.859	63.449	68.789	90.367	97.972	130.744
10	17.828	35.657	37.819	53.485	56.728	76.176	80.794	110.212
15	15.103	30.205	31.396	45.308	47.094	64.529	67.073	93.361
20	12.859	25.719	26.211	38.578	39.317	54.944	55.997	79.494
25	11.000	22.000	22.000	33.000	33.000	47.000	47.000	68.000
30	9.452	18.904	18.560	28.356	27.840	40.386	39.651	58.430
35	8.162	16.323	15.735	24.485	23.603	34.872	33.616	50.454
40	7.077	14.155	13.403	21.232	20.104	30.239	28.633	43.750
45	6.161	12.323	11.462	18.484	17.193	26.326	24.487	38.089
50	5.389	10.778	9.842	16.167	14.763	23.025	21.026	33.313
55	4.731	9.461	8.488	14.192	12.732	20.213	18.133	29.244
60	4.168	8.336	7.348	12.504	11.022	17.809	15.698	25.766
65	3.687	7.374	6.399	11.061	9.598	15.753	13.670	22.792
70	3.273	6.545	5.595	9.817	8.392	13.982	11.952	20.230
75	2.915	5.830	4.896	8.744	7.345	12.454	10.461	18.019
80	2.605	5.210	4.299	7.814	6.448	11.130	9.184	16.102
85	2.335	4.671	3.795	7.006	5.692	9.979	8.107	14.437
90	2.100	4.201	3.360	6.301	5.040	8.974	7.179	12.984
95	1.894	3.789	2.983	5.683	4.474	8.094	6.373	11.710
100	1.713	3.427	2.656	5.140	3.983	7.320	5.673	10.591
105	1.554	3.107	2.367	4.661	3.551	6.638	5.057	9.604
110	1.412	2.825	2.116	4.237	3.173	6.035	4.520	8.731
115	1.287	2.574	1.901	3.862	2.851	5.500	4.060	7.957
120	1.176	2.352	1.712	3.528	2.568	5.024	3.657	7.269
125	1.077	2.153	1.543	3.230	2.314	4.600	3.296	6.655

Part Number	NCP□□XC680	NCP□□YS101	NCP□□XF101	NCP□□XF151	NCP□□XM221	NCP□□XM331	NCP□□XQ471	NCP□□XQ681
Resistance	68Ω	100Ω	100Ω	150Ω	220Ω	330Ω	470Ω	680Ω
B-Constant	3100K	2750K	3250K	3250K	3500K	3500K	3650K	3650K
Temp. (°C)	Resistance (Ω)	Resistance (Ω)	Resistance (Ω)	Resistance (Ω)	Resistance (Ω)	Resistance (Ω)	Resistance (Ω)	Resistance (Ω)
-40	1099.815	1157.874	1824.175	2736.262	4947.904	7421.856	11822.473	17104.854
-35	846.832	924.204	1390.685	2086.028	3703.755	5555.632	8767.745	12685.248
-30	658.372	742.963	1070.653	1605.979	2798.873	4198.309	6570.224	9505.855
-25	516.007	601.346	831.138	1246.708	2135.887	3203.831	4971.784	7193.219
-20	407.991	490.422	650.960	976.440	1645.037	2467.555	3796.933	5493.436
-15	325.529	402.482	514.441	771.661	1278.034	1917.051	2923.400	4229.599
-10	261.707	331.760	409.700	614.550	1000.620	1500.930	2269.599	3283.675
-5	212.123	275.105	328.877	493.315	789.612	1184.418	1775.225	2568.411
0	173.033	229.324	265.759	398.639	627.752	941.628	1399.050	2024.158
5	141.747	192.270	215.785	323.677	502.474	753.711	1110.220	1606.275
10	116.894	162.076	176.395	264.592	405.010	607.514	887.257	1283.691
15	97.042	137.296	145.161	217.742	328.480	492.720	713.463	1032.245
20	81.016	116.902	120.152	180.228	268.044	402.066	577.375	835.351
25	68.000	100.000	100.000	150.000	220.000	330.000	470.000	680.000
30	57.368	85.927	83.669	125.503	181.576	272.365	384.800	556.733
35	48.636	74.197	70.361	105.541	150.668	226.002	316.757	458.287
40	41.426	64.339	59.456	89.184	125.681	188.521	262.177	379.320
45	35.428	56.013	50.470	75.705	105.336	158.004	218.069	315.504
50	30.421	48.989	43.029	64.543	88.717	133.076	182.297	263.749
55	26.235	43.006	36.830	55.246	75.059	112.588	153.150	221.579
60	22.712	37.891	31.649	47.473	63.777	95.666	129.249	186.998
65	19.778	33.517	27.364	41.045	54.415	81.622	109.551	158.499
70	17.293	29.750	23.756	35.634	46.631	69.946	93.281	134.960
75	15.134	26.498	20.651	30.976	40.115	60.172	79.750	115.383
80	13.288	23.680	18.011	27.016	34.637	51.955	68.446	99.029
85	11.729	21.231	15.800	23.700	30.013	45.019	58.996	85.356
90	10.386	19.094	13.908	20.862	26.110	39.165	51.036	73.839
95	9.220	17.221	12.263	18.394	22.790	34.186	44.332	64.140
100	8.208	15.575	10.844	16.265	19.957	29.935	38.640	55.905
105	7.317	14.124	9.622	14.434	17.541	26.312	33.790	48.888
110	6.539	12.840	8.563	12.844	15.453	23.180	29.664	42.918
115	5.874	11.702	7.648	11.472	13.663	20.494	26.123	37.795
120	5.291	10.690	6.850	10.275	12.114	18.171	23.091	33.409
125	4.768	9.787	6.162	9.243	10.778	16.168	20.472	29.618

Detailed Resistance - Temperature Tables are downloadable from the following URL.  
<http://search.murata.co.jp/Ceramy/CatsearchAction.do?sLang=en>

Continued on the following page.



## for Temp. Sensor and Compensation Chip Type Temperature Characteristics (Center Value)

Continued from the preceding page.

Part Number	NCP□□XM102	NCP□□XQ102	NCP□□XM152	NCP□□XW152	NCP□□XM222	NCP□□XW222	NCP□□XM332	NCP□□XW332
Resistance	1kΩ	1kΩ	1.5kΩ	1.5kΩ	2.2kΩ	2.2kΩ	3.3kΩ	3.3kΩ
B-Constant	3500K	3650K	3500K	3950K	3500K	3950K	3500K	3950K
Temp. (°C)	Resistance (kΩ)	Resistance (kΩ)	Resistance (kΩ)	Resistance (kΩ)	Resistance (kΩ)	Resistance (kΩ)	Resistance (kΩ)	Resistance (kΩ)
-40	21.266	25.154	31.899	51.791	46.786	75.961	70.179	113.941
-35	16.150	18.655	24.225	37.172	35.530	54.520	53.295	81.779
-30	12.347	13.979	18.520	27.005	27.162	39.607	40.743	59.411
-25	9.503	10.578	14.255	19.843	20.907	29.103	31.360	43.654
-20	7.365	8.079	11.047	14.728	16.203	21.601	24.304	32.401
-15	5.747	6.220	8.621	11.044	12.644	16.198	18.966	24.297
-10	4.516	4.829	6.773	8.362	9.934	12.264	14.901	18.396
-5	3.572	3.777	5.358	6.389	7.858	9.370	11.787	14.055
0	2.844	2.977	4.266	4.922	6.257	7.219	9.386	10.829
5	2.280	2.362	3.419	3.825	5.015	5.609	7.523	8.414
10	1.839	1.888	2.758	2.994	4.045	4.391	6.067	6.586
15	1.492	1.518	2.238	2.361	3.283	3.463	4.924	5.195
20	1.218	1.229	1.827	1.876	2.680	2.751	4.019	4.126
25	1.000	1.000	1.500	1.500	2.200	2.200	3.300	3.300
30	0.825	0.819	1.238	1.207	1.816	1.771	2.724	2.656
35	0.685	0.674	1.027	0.978	1.507	1.434	2.260	2.152
40	0.571	0.558	0.857	0.797	1.257	1.169	1.885	1.753
45	0.479	0.464	0.718	0.653	1.053	0.958	1.580	1.437
50	0.403	0.388	0.605	0.538	0.887	0.789	1.331	1.184
55	0.341	0.326	0.512	0.446	0.751	0.654	1.126	0.981
60	0.290	0.275	0.435	0.371	0.638	0.545	0.957	0.817
65	0.247	0.233	0.371	0.311	0.544	0.456	0.816	0.684
70	0.212	0.199	0.318	0.261	0.466	0.383	0.700	0.575
75	0.182	0.170	0.274	0.221	0.401	0.324	0.602	0.486
80	0.157	0.146	0.236	0.187	0.346	0.275	0.520	0.412
85	0.136	0.126	0.205	0.160	0.300	0.234	0.450	0.351
90	0.119	0.109	0.178	0.137	0.261	0.200	0.392	0.301
95	0.104	0.094	0.155	0.117	0.228	0.172	0.342	0.258
100	0.091	0.082	0.136	0.101	0.200	0.149	0.299	0.223
105	0.080	0.072	0.120	0.088	0.175	0.129	0.263	0.193
110	0.070	0.063	0.105	0.076	0.155	0.112	0.232	0.168
115	0.062	0.056	0.093	0.067	0.137	0.098	0.205	0.146
120	0.055	0.049	0.083	0.058	0.121	0.085	0.182	0.128
125	0.049	0.044	0.074	0.051	0.108	0.075	0.162	0.113

Part Number	NCP□□XM472	NCP□□XH682	NCP□□XW682	NCP□□XH103	NCP□□XV103	NCP□□XH153	NCP□□XW153	NCP□□XH223
Resistance	4.7kΩ	6.8kΩ	6.8kΩ	10kΩ	10kΩ	15kΩ	15kΩ	22kΩ
B-Constant	3500K	3380K	3950K	3380K	3900K	3380K	3950K	3380K
Temp. (°C)	Resistance (kΩ)	Resistance (kΩ)	Resistance (kΩ)	Resistance (kΩ)	Resistance (kΩ)	Resistance (kΩ)	Resistance (kΩ)	Resistance (kΩ)
-40	105.705	133.043	234.787	195.652	328.996	293.478	517.912	430.434
-35	79.126	100.756	168.515	148.171	237.387	222.256	371.724	325.976
-30	59.794	77.076	122.422	113.347	173.185	170.021	270.048	249.364
-25	45.630	59.540	89.953	87.559	127.773	131.338	198.426	192.629
-20	35.144	46.401	66.766	68.237	95.327	102.355	147.278	150.121
-15	27.303	36.482	50.066	53.650	71.746	80.474	110.439	118.029
-10	21.377	28.904	37.906	42.506	54.564	63.759	83.617	93.514
-5	16.869	23.047	28.963	33.892	41.813	50.838	63.888	74.563
0	13.411	18.509	22.313	27.219	32.330	40.828	49.221	59.881
5	10.735	14.974	17.338	22.021	25.194	33.032	38.245	48.446
10	8.653	12.189	13.571	17.926	19.785	26.888	29.936	39.436
15	7.018	9.978	10.705	14.674	15.651	22.010	23.613	32.282
20	5.726	8.215	8.503	12.081	12.468	18.121	18.756	26.577
25	4.700	6.800	6.800	10.000	10.000	15.000	15.000	22.000
30	3.879	5.654	5.474	8.315	8.072	12.472	12.074	18.292
35	3.219	4.725	4.434	6.948	6.556	10.422	9.780	15.285
40	2.685	3.967	3.613	5.834	5.356	8.751	7.969	12.834
45	2.250	3.344	2.961	4.917	4.401	7.375	6.531	10.817
50	1.895	2.829	2.440	4.161	3.635	6.241	5.382	9.154
55	1.604	2.404	2.022	3.535	3.019	5.302	4.459	7.777
60	1.363	2.050	1.683	3.014	2.521	4.521	3.713	6.631
65	1.163	1.759	1.409	2.586	2.115	3.879	3.108	5.690
70	0.996	1.515	1.185	2.228	1.781	3.341	2.613	4.901
75	0.857	1.309	1.001	1.925	1.509	2.887	2.208	4.234
80	0.740	1.135	0.849	1.669	1.284	2.503	1.873	3.671
85	0.641	0.988	0.724	1.452	1.097	2.178	1.597	3.195
90	0.558	0.862	0.620	1.268	0.941	1.902	1.367	2.790
95	0.487	0.755	0.532	1.110	0.810	1.664	1.174	2.441
100	0.426	0.662	0.459	0.974	0.701	1.461	1.013	2.142
105	0.375	0.583	0.398	0.858	0.608	1.287	0.878	1.888
110	0.330	0.515	0.346	0.758	0.530	1.137	0.763	1.668
115	0.292	0.457	0.302	0.672	0.463	1.007	0.665	1.477
120	0.259	0.406	0.264	0.596	0.406	0.895	0.582	1.312
125	0.230	0.361	0.232	0.531	0.358	0.797	0.511	1.169

Detailed Resistance - Temperature Tables are downloadable from the following URL.  
<http://search.murata.co.jp/Ceramy/CatsearchAction.do?sLang=en>

Continued on the following page. 

## for Temp. Sensor and Compensation Chip Type Temperature Characteristics (Center Value)

Continued from the preceding page.

Part Number	NCP□□XW223	NCP□□WL223	NCP□□WB333	NCP□□WF333	NCP□□WL333	NCP□□WB473	NCP□□WL473	NCP□□WD683
Resistance	22kΩ	22kΩ	33kΩ	33kΩ	33kΩ	47kΩ	47kΩ	68kΩ
B-Constant	3950K	4485K	4050K	4250K	4485K	4050K	4485K	4150K
Temp. (°C)	Resistance (kΩ)	Resistance (kΩ)	Resistance (kΩ)	Resistance (kΩ)	Resistance (kΩ)	Resistance (kΩ)	Resistance (kΩ)	Resistance (kΩ)
-40	759.605	1073.436	1227.263	1451.049	1610.154	1747.920	2293.249	2735.359
-35	545.196	753.900	874.449	1019.238	1130.850	1245.428	1610.605	1937.391
-30	396.070	535.073	630.851	725.084	802.609	898.485	1143.110	1389.345
-25	291.025	383.590	460.457	522.021	575.385	655.802	819.487	1008.014
-20	216.008	277.643	339.797	379.842	416.464	483.954	593.146	738.978
-15	161.977	202.813	253.363	279.371	304.219	360.850	433.281	547.456
-10	122.638	149.462	190.766	207.566	224.193	271.697	319.305	409.600
-5	93.702	111.082	144.964	155.639	166.623	206.463	237.312	309.217
0	72.191	83.233	111.087	117.814	124.850	158.214	177.816	235.606
5	56.093	62.858	85.842	89.925	94.287	122.259	134.287	180.980
10	43.907	47.831	66.861	69.204	71.747	95.227	102.184	140.139
15	34.633	36.664	52.470	53.675	54.996	74.730	78.327	109.344
20	27.509	28.304	41.471	41.937	42.455	59.065	60.467	85.929
25	22.000	22.000	33.000	33.000	33.000	47.000	47.000	68.000
30	17.709	17.214	26.430	26.143	25.822	37.643	36.776	54.167
35	14.344	13.557	21.298	20.845	20.335	30.334	28.962	43.421
40	11.688	10.744	17.266	16.723	16.115	24.591	22.952	35.016
45	9.578	8.566	14.076	13.498	12.849	20.048	18.301	28.406
50	7.894	6.871	11.538	10.954	10.306	16.433	14.679	23.166
55	6.540	5.543	9.506	8.940	8.314	13.539	11.842	18.997
60	5.446	4.497	7.870	7.334	6.746	11.209	9.607	15.657
65	4.559	3.669	6.549	6.046	5.503	9.328	7.837	12.967
70	3.832	3.009	5.475	5.011	4.513	7.798	6.428	10.794
75	3.239	2.481	4.595	4.170	3.721	6.544	5.300	9.021
80	2.748	2.056	3.874	3.487	3.084	5.518	4.393	7.575
85	2.342	1.713	3.282	2.928	2.569	4.674	3.659	6.387
90	2.004	1.434	2.789	2.469	2.151	3.972	3.063	5.407
95	1.722	1.206	2.379	2.091	1.809	3.388	2.577	4.598
100	1.486	1.019	2.038	1.777	1.529	2.902	2.178	3.922
105	1.287	0.866	1.751	1.516	1.299	2.494	1.849	3.359
110	1.119	0.739	1.509	1.298	1.108	2.150	1.578	2.887
115	0.975	0.633	1.306	1.116	0.949	1.860	1.352	2.489
120	0.854	0.545	1.134	0.962	0.817	1.615	1.164	2.155
125	0.750	0.471	0.987	0.832	0.707	1.406	1.006	1.870

Part Number	NCP□□WF683	NCP□□WL683	NCP□□WF104	NCP18WF104F	NCP□□WL104	NCP□□WL154	NCP□□WM154	NCP□□WL224
Resistance	68kΩ	68kΩ	100kΩ	100kΩ±1%	100kΩ	150kΩ	150kΩ	220kΩ
B-Constant	4250K	4485K	4250K	4200K	4485K	4485K	4500K	4485K
Temp. (°C)	Resistance (kΩ)	Resistance (kΩ)	Resistance (kΩ)	Resistance (kΩ)	Resistance (kΩ)	Resistance (kΩ)	Resistance (kΩ)	Resistance (kΩ)
-40	2990.041	3317.893	4397.119	4205.686	4879.254	7318.881	7899.466	10734.358
-35	2100.247	2330.237	3088.599	2966.436	3426.818	5140.228	5466.118	7539.001
-30	1494.113	1653.862	2197.225	2118.789	2432.149	3648.224	3834.499	5350.729
-25	1075.679	1185.641	1581.881	1531.319	1743.590	2615.385	2720.523	3835.898
-20	782.705	858.168	1151.037	1118.422	1262.012	1893.018	1951.216	2776.427
-15	575.674	626.875	846.579	825.570	921.875	1382.813	1415.565	2028.126
-10	427.712	461.974	628.988	615.526	679.373	1019.059	1036.984	1494.620
-5	320.710	343.345	471.632	463.104	504.919	757.379	767.079	1110.822
0	242.768	257.266	357.012	351.706	378.333	567.499	572.667	832.332
5	185.300	194.287	272.500	269.305	285.717	428.575	431.264	628.577
10	142.603	147.841	209.710	207.891	217.414	326.121	327.405	478.310
15	110.602	113.325	162.651	161.722	166.654	249.981	250.538	366.639
20	86.415	87.484	127.080	126.723	128.653	192.979	193.166	283.036
25	68.000	68.000	100.000	100.000	100.000	150.000	150.000	220.000
30	53.871	53.208	79.222	79.439	78.247	117.370	117.281	172.143
35	42.954	41.903	63.167	63.509	61.622	92.433	92.293	135.569
40	34.460	33.208	50.677	51.084	48.835	73.252	73.090	107.436
45	27.814	26.477	40.904	41.336	38.937	58.406	58.240	85.662
50	22.572	21.237	33.195	33.628	31.231	46.846	46.665	68.708
55	18.422	17.133	27.091	27.510	25.195	37.793	37.605	55.429
60	15.113	13.900	22.224	22.621	20.441	30.661	30.453	44.970
65	12.459	11.339	18.323	18.692	16.675	25.013	24.804	36.686
70	10.325	9.300	15.184	15.525	13.677	20.516	20.293	30.090
75	8.592	7.668	12.635	12.947	11.277	16.916	16.679	24.810
80	7.185	6.356	10.566	10.849	9.346	14.019	13.776	20.562
85	6.033	5.294	8.873	9.129	7.785	11.678	11.428	17.128
90	5.087	4.432	7.481	7.713	6.517	9.776	9.520	14.338
95	4.309	3.728	6.337	6.546	5.482	8.223	7.966	12.061
100	3.661	3.151	5.384	5.572	4.634	6.951	6.688	10.194
105	3.124	2.676	4.594	4.764	3.935	5.902	5.639	8.657
110	2.675	2.283	3.934	4.087	3.357	5.035	4.772	7.385
115	2.299	1.956	3.380	3.518	2.877	4.315	4.052	6.329
120	1.983	1.684	2.916	3.040	2.476	3.714	3.454	5.448
125	1.715	1.456	2.522	2.634	2.141	3.211	2.955	4.710

Detailed Resistance - Temperature Tables are downloadable from the following URL.  
<http://search.murata.co.jp/Ceramy/CatsearchAction.do?sLang=en>

Continued on the following page. ↗

## for Temp. Sensor and Compensation Chip Type Temperature Characteristics (Center Value)

Continued from the preceding page.

Part Number	NCP□□WM224	NCP□□WM474
Resistance	220kΩ	470kΩ
B-Constant	4500K	4500K
Temp. (°C)	Resistance (kΩ)	Resistance (kΩ)
-40	11585.884	24751.661
-35	8016.973	17127.169
-30	5623.931	12014.762
-25	3990.100	8524.305
-20	2861.784	6113.811
-15	2076.162	4435.437
-10	1520.909	3249.216
-5	1125.049	2403.515
0	839.912	1794.358
5	632.521	1351.294
10	480.194	1025.870
15	367.455	785.018
20	283.310	605.252
25	220.000	470.000
30	172.012	367.480
35	135.364	289.186
40	107.198	229.014
45	85.419	182.485
50	68.441	146.215
55	55.153	117.828
60	44.665	95.420
65	36.379	77.718
70	29.763	63.584
75	24.462	52.260
80	20.205	43.166
85	16.761	35.808
90	13.962	29.828
95	11.684	24.961
100	9.809	20.955
105	8.270	17.668
110	6.998	14.951
115	5.942	12.695
120	5.067	10.824
125	4.334	9.259

Detailed Resistance - Temperature Tables are downloadable from the following URL.  
<http://search.murata.co.jp/Ceramy/CatsearchAction.do?sLang=en>

## for Temp. Sensor and Compensation Chip Type ⚠Caution/Notice

### ■ ⚠Caution (Storage and Operating Conditions)

This product is designed for application in an ordinary environment (normal room temperature, humidity and atmospheric pressure).

Do not use under the following conditions because all these factors can deteriorate the product characteristics or cause failures and burn-out.

1. Corrosive gas or deoxidizing gas  
(Chlorine gas, Hydrogen sulfide gas, Ammonia gas, Sulfuric acid gas, Nitric oxide gas, etc.)
2. Volatile or flammable gas
3. Dusty conditions
4. Under vacuum, or under high or low-pressure
5. Wet or humid locations
6. Places with salt water, oils, chemical liquids or organic solvents
7. Strong vibrations
8. Other places where similar hazardous conditions exist

### ■ ⚠Caution (Others)

Be sure to provide an appropriate fail-safe function on your product to prevent secondary damages that may be caused by the abnormal function or the failure of our product.

### ■ Notice (Storage and Operating Conditions)

To keep solderability of product from declining, the following storage condition is recommended.

1. Storage condition:  
Temperature -10 to +40 degrees C  
Humidity less than 75%RH (not dewing condition)
2. Storage term:  
Use this product within 6 months after delivery by first-in and first-out stocking system.
3. Storage place:  
Do not store this product in corrosive gas (Sulfuric acid gas, Chlorine gas, etc.) or in direct sunlight.

### ■ Notice (Rating)

Use this product within the specified temperature range.

Higher temperature may cause deterioration of the characteristics or the material quality of this product.

### ■ Notice (Handling)

The ceramic of this product is fragile, and care must be taken not to load an excessive press - force or not to give a shock at handling.

Such forces may cause cracking or chipping.

**for Temp. Sensor and Compensation Chip Type ⚠Caution/Notice**

■ Notice (Soldering and Mounting)

1. Mounting Position

Choose a mounting position that minimizes the stress imposed on the chip during flexing or bending of the board.

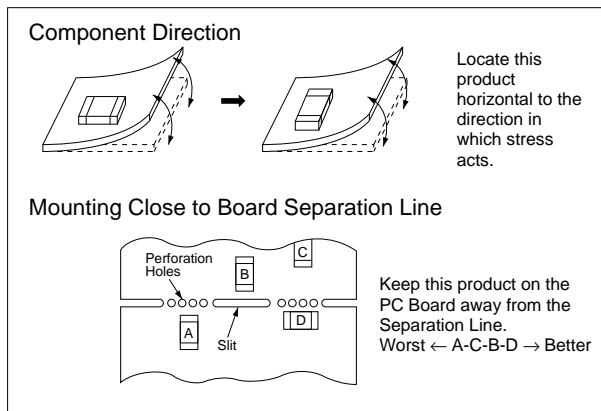

2. Allowable Soldering Temperature and Time

- (a) Solder within the temperature and time combinations, indicated by the slanted lines in the following graphs.
- (b) The excessive soldering conditions may cause dissolution of metallization or deterioration of solder-wetting on the external electrode.
- (c) In case of repeated soldering, the accumulated soldering time should be within the range shown below figure. (For example, Reflow peak temperature: 260°C, twice -> The total accumulated soldering time at 260°C is within 30 seconds.)

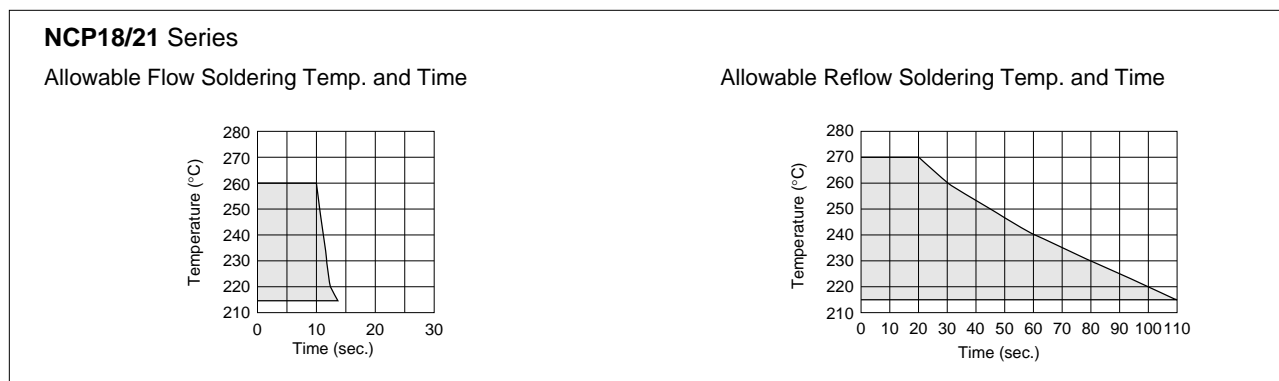
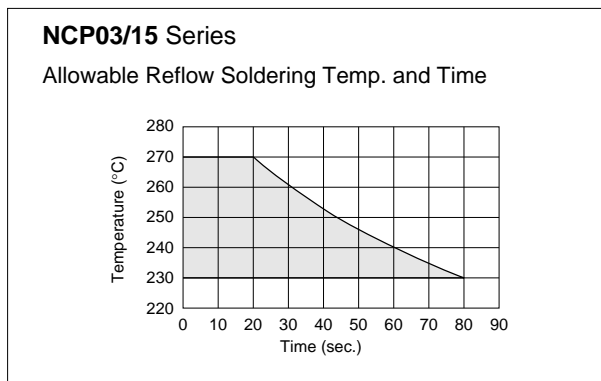

Continued on the following page. ↗

## for Temp. Sensor and Compensation Chip Type ⚠ Caution/Notice

☒ Continued from the preceding page.

### 3. Recommendable Temperature Profile for Soldering

- (a) Insufficient preheating may cause a crack on ceramic body. The difference between preheating temperature and maximum temperature in the profile shall be 100 °C.
- (b) Rapid cooling by dipping in solvent or by other means is not recommended.

\* In case of repeated soldering, the accumulated soldering time should be within the range shown above figure 2.

#### NCP03/15 Series

##### Reflow Soldering Conditions

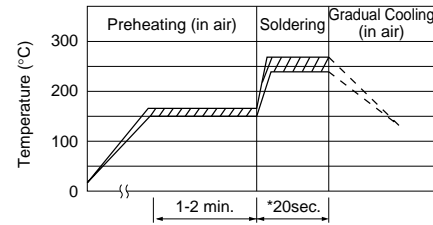

Preheating: 160±10°C, 1-2 min.  
Soldering: 240-270°C, 20sec.

#### NCP18/21 Series

##### Flow Soldering Conditions

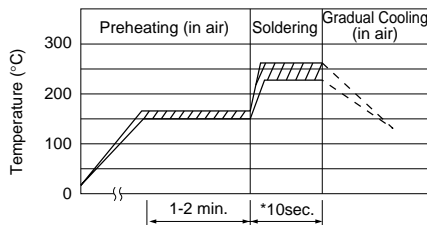

Preheating: 160±10°C, 1-2 min.  
Soldering: 230-260°C, 10sec.

##### Reflow Soldering Conditions

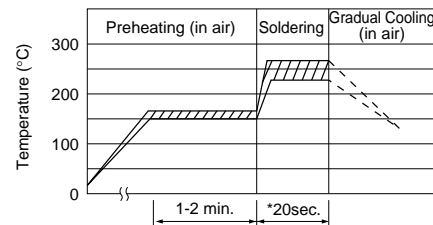

Preheating: 160±10°C, 1-2 min.  
Soldering: 230-270°C, 20sec.

### 4. Solder and Flux

#### (1) Solder and Paste

##### (a) Reflow Soldering: NCP03/15/18/21 Series

Use RA/RMA type or equivalent type of solder paste. For your reference, we are using the solder paste below for any internal tests of this product.

- RMA9086 90-4-M20 (Sn:Pb=63wt%:37wt%)  
(Manufactured by Alpha Metals Japan Ltd.)
- M705-221BM5-42-11 (Sn:Ag:Cu=96.5wt%:3.0wt%:0.5wt%)  
(Manufactured by Senju Metal Industry Co., Ltd.)

##### (b) Flow Soldering: NCP18/21 Series

We are using the solder paste below for any internal tests of this product.

- Sn:Pb=63wt%:37wt%
- Sn:Ag:Cu=96.5wt%:3.0wt%:0.5wt%

#### (2) Flux

Use rosin type flux in soldering process.

If below flux is used, some problems might be caused in the product characteristics and reliability.

Please do not use below flux.

- Strong acidic flux (with halide content exceeding 0.1wt%).
- Water-soluble flux  
(\*Water-soluble flux can be defined as non rosin type flux including wash-type flux and non-wash-type flux.)

### 5. Cleaning Conditions

For removing the flux after soldering, observe the following points in order to avoid deterioration of the characteristics or any change of the external electrodes' quality.

- Please keep mounted parts and a substrate from an occurrence of resonance in ultrasonic cleaning.
- Please do not clean the products in the case of using a non-washed type flux.

### 6. Drying

After cleaning, promptly dry this product.

	NCP03/15	NCP18/21
Solvent	Isopropyl Alcohol	Isopropyl Alcohol
Dipping Cleaning	Less than 5 minutes at room temp. or less than 2 minutes at 40°C max.	Less than 5 minutes at room temp. or less than 2 minutes at 40°C max.
Ultrasonic Cleaning	Less than 5 minutes and 20W/ℓ Frequency of 28kHz to 40kHz	Less than 1 minute and 20W/ℓ Frequency of several 10kHz to 100kHz

Continued on the following page. ↗

**for Temp. Sensor and Compensation Chip Type ⚠Caution/Notice**

☒ Continued from the preceding page.

**7. Printing Conditions of Solder Paste**

- The amount of solder is critical. Standard height of fillet is shown in the table below.
- Too much soldering may cause mechanical stress, resulting in cracking, mechanical and/or electronic damage.

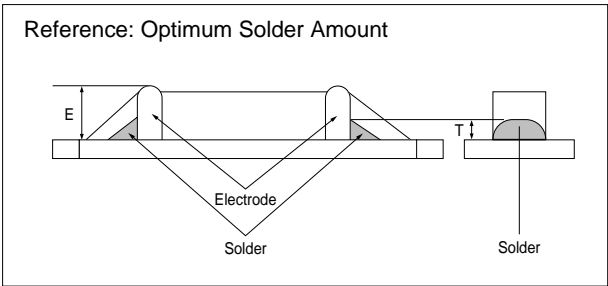

Part Number	The Solder Paste Thickness	T
<b>NCP03</b>	100μm	$1/3E \leq T \leq E$
<b>NCP15</b>	150μm	$1/3E \leq T \leq E$
<b>NCP18/NCP21</b>	200μm	$0.2\text{mm} \leq T \leq E$

**8. Adhesive Application and Curing**

- Thin or insufficient adhesive may result in loose component contact with land during flow soldering.
- Low viscosity adhesive causes chips to slip after mounting.

## for Temp. Sensor and Compensation Chip Type Package

### ■ Minimum Quantity Guide

Part Number	Quantity (pcs.)	
	Paper Tape	Embossed Tape
NCP03	15000	-
NCP15	10000	
NCP18	4000	
NCP21	-	4000

### ■ Tape Carrier Packaging

#### 1. Dimensions of Reel

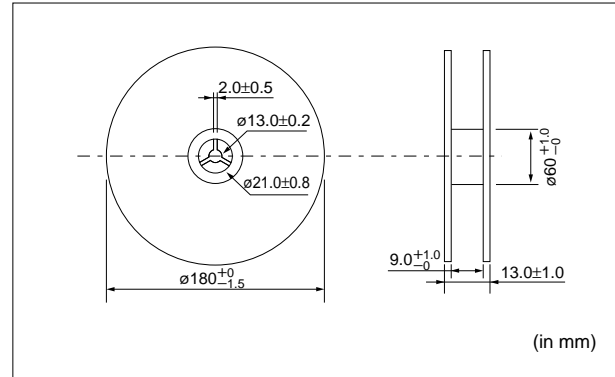

#### 2. Taping Method

- (1) A tape in a reel contains Leader unit and Trailer unit where products are not packed. (Please refer to the figure right.)
- (2) The top and base tapes or plastic and cover tape are not stuck at the first five pitches minimum.
- (3) A label should be attached on the reel. (MURATA's part number, inspection number and quantity should be marked on the label.)
- (4) Taping reels are packed in a package.

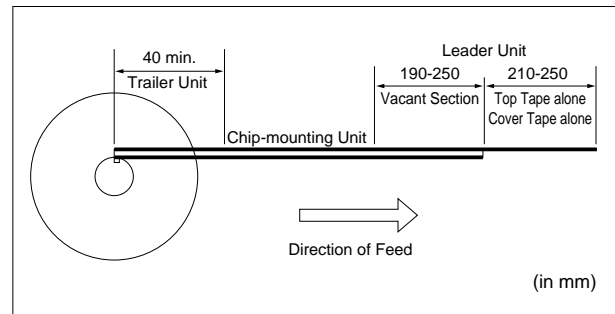

Continued on the following page.



## for Temp. Sensor and Compensation Chip Type Package

Continued from the preceding page.

### 3. Paper Tape (NCP03/15/18 Series)

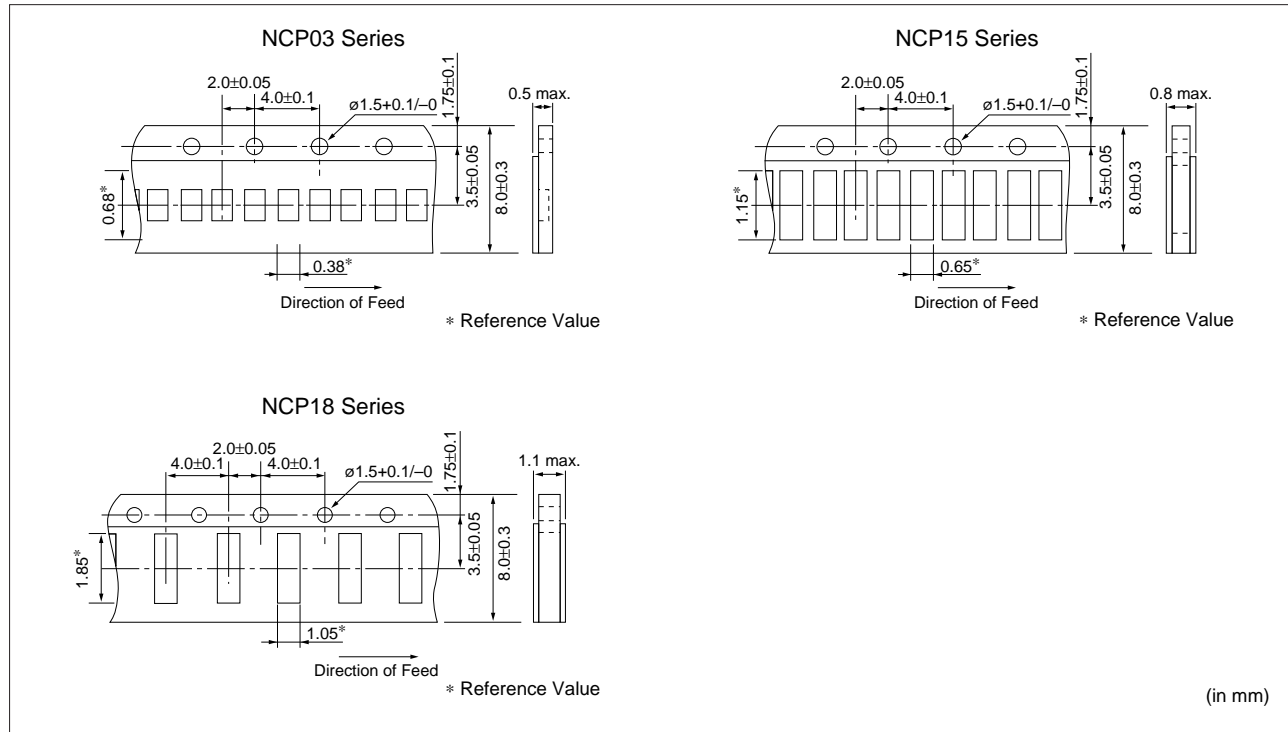

#### (1) Other Conditions

##### (a) Packaging

Products are packaged in the cavity of the base tape and sealed by top tape and bottom tape.

##### (b) Tape

Top tape and bottom tape have no joints and products are packaged and sealed in the cavity of the base tape, continuously.

#### (2) Peeling Force of Top Tape

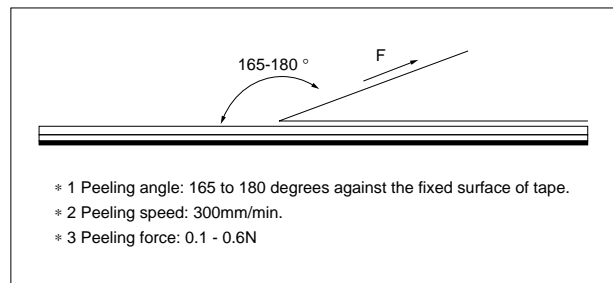

#### (3) Pull Strength

Pull strength of top tape is specified at 10N minimum.

Pull strength of bottom tape should be specified 5N minimum.

Continued on the following page. ↗

## for Temp. Sensor and Compensation Chip Type Package

Continued from the preceding page.

### 4. Embossed Tape (NCP21 Series)

#### (1) Other Conditions

##### (a) Packaging

Products are packaged in each cavity of the Embossed tape and sealed by Cover tape.

##### (b) Tape

Cover tape has no joints.

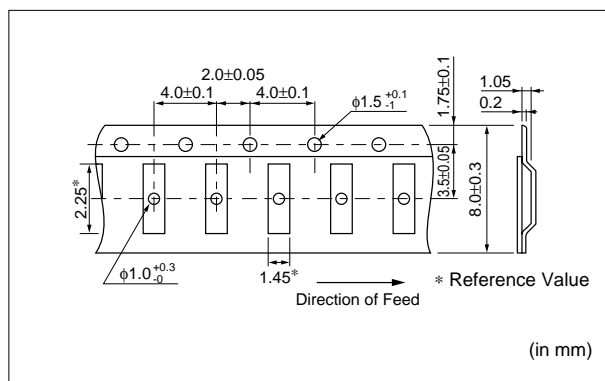

#### (2) Peeling Force of Cover Tape

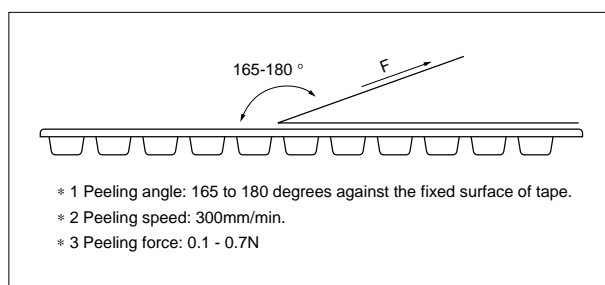

#### (3) Tape Strength

Pull strength of Embossed tape and Cover tape should be specified 10N minimum.

# NTC Thermistors



## for Temperature Sensor Thermo String Type

This product is a small flexible lead type NTC Thermistor with the small head and the thin lead wire.

### ■ Features

1. High accuracy and high sensibility temperature sensing is available by the small size and high accuracy NTC Thermistor.
2. Narrow space temperature sensing is available by the small sensing head and the thin lead wire.
3. Flexibility and wide variety length (25 mm to 150mm) enables designing flexible temperature sensing architectures.
4. This product is compatible with our 0402 (EIA) size chip Thermistor.
5. Excellent long time aging stability
6. This is halogen free product. \*  
\* Cl= max.900ppm, Br=max.900ppm and  
Cl+Br=max.1500ppm
7. NXFT series are recognized by UL/cUL.  
(UL1434, File No.E137188).

### ■ Applications

1. Temperature compensation for transistor, IC and crystal oscillator in mobile communications
2. Temperature sensor for rechargeable batteries
3. Temperature compensation of LCD
4. Temperature compensation in general use of electric circuits

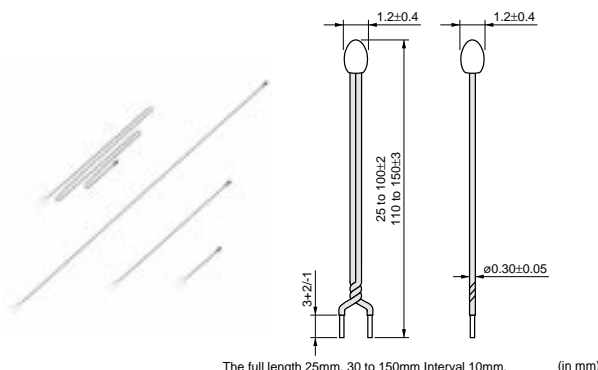

The full length 25mm, 30 to 150mm Interval 10mm. (in mm)

NXFT15\_1B Type(twist)

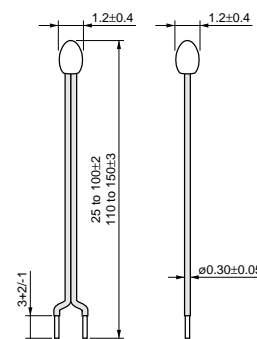

The full length 25mm, 30 to 150mm Interval 10mm. (in mm)

NXFT15\_2B Type(without twist)

5

Part Number	Resistance (25°C) (ohm)	B-Constant (25-50°C) (K)	B-Constant (25-80°C) (Reference Value) (K)	B-Constant (25-85°C) (Reference Value) (K)	B-Constant (25-100°C) (Reference Value) (K)	Operating Current for Sensor (25°C) (mA)	Rated Electric Power (25°C) (mW)	Typical Dissipation Constant (25°C) (mW/°C)	Thermal Time Constant (s)
NXFT15XH103FA□B□□□	10k	3380 ±1%	3423	3431	3452	0.12	7.5	1.5	4
NXFT15WB473FA□B□□□	47k	4050 ±1%	4091	4097	4114	0.06	7.5	1.5	4
NXFT15WF104FA□B□□□	100k	4250 ±1%	4303	4311	4334	0.04	7.5	1.5	4

□ is the filled with lead shape (1:twist, 2:without twist).

□□□ is the filled with Total-length codes. (25mm, 30 to 150mm interval 10mm, ex. 050=50mm)

Operating Current for Sensor rises Thermistor's temperature by 0.1.°C

Rated Electric Power is necessary electric power that Thermistor's temperature rises 5°C by self heating at 25°C in still air.

Operating Temperature Range: -40°C to +125°C

## for Temperature Sensor Thermo String Type Specifications and Test Methods

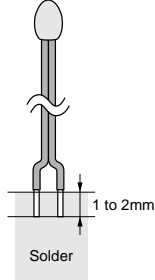
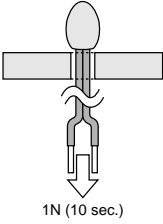
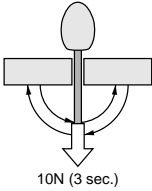
No.	Item	Specifications	Test Methods
1	High Temperature Storage Test	<ul style="list-style-type: none"> <li>Resistance (R25°C) fluctuation rate: less than ±1%.</li> <li>B-Constant (B25/50°C) fluctuation rate: less than ±1%.</li> </ul>	125±2°C in air, for 1000 +48/-0 hours without loading.
2	Low Temperature Storage Test		-40 +0/-3°C in air, for 1000 +48/-0 hours without loading.
3	Humidity Storage Test	<ul style="list-style-type: none"> <li>Resistance (R25°C) fluctuation rate: less than ±2%.</li> <li>B-Constant (B25/50°C) fluctuation rate: less than ±1%.</li> </ul>	60±2°C, 90 to 95%RH in air, for 1000 +48/-0 hours without loading.
4	Temperature Cycle		-40 +0/-3°C, 30 minutes in air +25±2°C, 10 to 15 minutes in air +125±2°C, 30 minutes in air + 25 +2/-0°C, 10 to 15 minutes in air (1 cycle) Continuous 100 cycles, without loading.
5	High Temperature Load		85±2°C in air, with 'Operating Current for Sensor' for 1000 +48/-0 hrs.
6	Insulation Break - down Voltage	<ul style="list-style-type: none"> <li>No damage electrical characteristics on DC100 V, 1 min.</li> </ul>	2mm length of coating resin from the top of Thermistor is to be dipped into beads of lead (Pb), and DC100V 1 minute is applied to circuit between beads of lead (Pb) and lead wire.
7	Resistance to Soldering Heat	<ul style="list-style-type: none"> <li>Resistance (R25°C) fluctuation rate: less than ±1%.</li> <li>B-Constant (B25/50°C) fluctuation rate: less than ±1%.</li> </ul>	<p>Both lead wires are dipped into 350±10°C solder for 3.5±0.5 seconds, or 260±5°C solder for 10±1 seconds according to Fig-1. (solder &lt;JIS Z 3282 H60A&gt;)</p>  <p>Fig-1</p>
8	Solderability	More than 90% of lead wire surface shall be covered by solder.	<p>Both lead wires are dipped into flux (25wt% colophony &lt;JIS K 5902&gt; isopropyl alcohol &lt;JIS K 8839&gt;) for 5 to 10 seconds. Then both lead wires are dipped into 235±5°C solder &lt;JIS Z 3282 H60A&gt; for 2±0.5 seconds according to Fig-1.</p>
9	Lead Wire Pull Strength	<ul style="list-style-type: none"> <li>Resistance (R25°C) fluctuation rate: less than ±1%.</li> <li>B-Constant (B25/50°C) fluctuation rate: less than ±1%.</li> </ul>	<p>The lead wire shall be inserted in a ø1.0mm hole until resin part contacts with a substrate as shown in fig-2. And 1N force for 10 seconds shall be applied to the lead wire.</p>  <p>Fig-2</p>
10	Lead Wire Bending Strength	<ul style="list-style-type: none"> <li>Lead wire does not break.</li> </ul>	<p>Hold the lead wires like Fig-3. Bend by 90 degrees and again bend back to the initial position. Then bend to the other side by 90 degrees and again bend back to the initial position. After bending process, 10N force for 3 seconds shall be applied to the lead wire.</p>  <p>Fig-3</p>

- \* R25 is zero-power resistance at 25°C.
- B25/50 is calculated by zero-power resistance of Thermistor in 25°C -50°C.
- After each test, NTC Thermistor should be kept for 1 hour at room temperature (normal humidity and normal atmospheric pressure).

Continued on the following page. 

## for Temperature Sensor Thermo String Type Specifications and Test Methods

Continued from the preceding page.

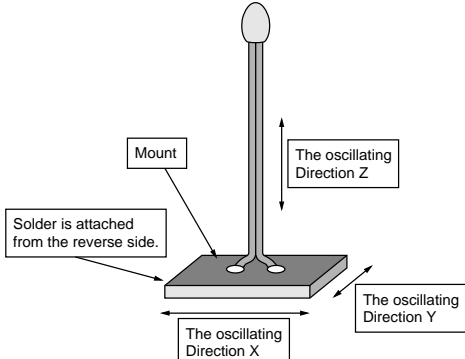
No.	Item	Specifications	Test Methods
11	Free Fall		NTC Thermistor shall be dropped without any force onto concrete floor from 1 meter height one time.
12	Vibration	<ul style="list-style-type: none"> <li>• Resistance (R25°C) fluctuation rate: less than ±1%.</li> <li>• B-Constant (B25/50°C) fluctuation rate: less than ±1%.</li> <li>• No visible damage at resin part.</li> </ul>	<p>NTC Thermistor shall be fixed to the vibration test equipment. Vibration of total 1.5 mm amplitude, Frequency sequence of 10Hz - 55Hz - 10Hz in 1 minute, shall be applied for right angled 3 directions for each 2 hours duration.</p> 

- \* • R25 is zero-power resistance at 25°C.
- B25/50 is calculated by zero-power resistance of Thermistor in 25°C -50°C.
- After each test, NTC Thermistor should be kept for 1 hour at room temperature (normal humidity and normal atmospheric pressure).

# NTC Thermistors



## for Temperature Sensor Lead Type

This product is a sensor type NTC Thermistor to be useful in the normal temperature range developed by the unique ceramic technology and the automatic assembly.

### ■ Features

1. High-accuracy of B-Constant tolerance  $\pm 0.5\%$   $\pm 1\%$  of resistance and  $\pm 0.5\%$  of B-Constant is realized due to technical advantages of the material and manufacturing process.
2. Quick response  
This product provides faster response time due to its smaller size.
3. Taping type is available.
4. Strong lead strength  
Original lead-wiring technique assures reliable connection. It can be formed and bent flexibly according to the mounting conditions.

### ■ Applications

1. Rechargeable batteries
2. Battery charging circuits
3. Head of printers
4. DC fan motors
5. Home appliance equipments

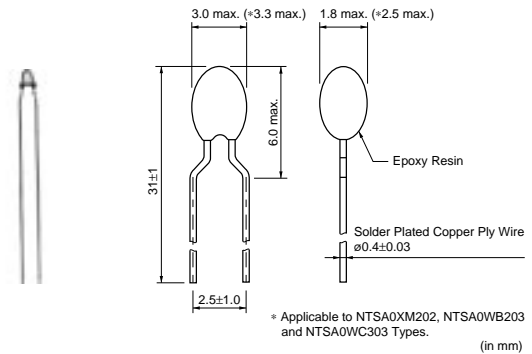

6

Part Number	Resistance (25°C) (ohm)	B-Constant (25-50°C) (K)	B-Constant (25-80°C) (Reference Value) (K)	B-Constant (25-85°C) (Reference Value) (K)	B-Constant (25-100°C) (Reference Value) (K)	Permissible Operating Current (25°C) (mA)	Rated Electric Power (25°C) (mW)	Typical Dissipation Constant (25°C) (mW/°C)	Thermal Time Constant (s)
NNTSA0XM202□E1B0	2.0k	3500 $\pm 0.5\%$	3523	3526	3543	1.05	21	2.1	7
NNTSA0XR502□E1B0	5.0k	3700 $\pm 1\%$	3727	3738	3760	0.68	15	1.5	7
NNTSA0XH103□E1B0	10k	3380 $\pm 0.5\%$	3428	3434	3455	0.38	15	1.5	7
NNTSA0XV103□E1B0	10k	3900 $\pm 0.5\%$	3930	3934	3944	0.46	15	1.5	7
NNTSA0WB203□E1B0	20k	4050 $\pm 1\%$	4078	4080	4096	0.31	21	2.1	7
NNTSA0WC303□E1B0	30k	4100 $\pm 1\%$	4128	4130	4147	0.26	21	2.1	7
NNTSA0WD503□E1B0	50k	4150 $\pm 1\%$	4205	4213	4234	0.20	15	1.5	7
NNTSA0WF104□E1B0	100k	4250 $\pm 1\%$	4303	4311	4334	0.14	15	1.5	7

A blank column is filled with resistance tolerance codes (F:  $\pm 1\%$ , E:  $\pm 3\%$ ).

Rated Electric Power is necessary electric power that Thermistor's temperature rises 10°C by self heating at 25°C in still air.

Operating Temperature Range: -40°C to +125°C

Taping type of part numbers with "N6A0" is available (Lead spacing=5mm).

# NTC Thermistors



## for Temperature Sensor Lead Insulation Type

This product is a sensor type NTC Thermistor to be useful in the normal temperature range developed by the unique ceramic technology and the automatic assembly.

### ■ Features

1. Electric insulation on lead wire
2. Excellent bending resistance due to suitable hardness of surface coating
3. Easy handling due to most suitable hardness of surface of coating
4. High-accuracy of B-Constant tolerance  $\pm 0.5\%$   $\pm 1\%$  of resistance and  $\pm 0.5\%$  of B-Constant is realized due to technical advantages of the material and manufacturing process.

### ■ Applications

1. Rechargeable batteries
2. Battery charging circuits
3. Head of printers
4. DC fan motors
5. Home appliance equipments

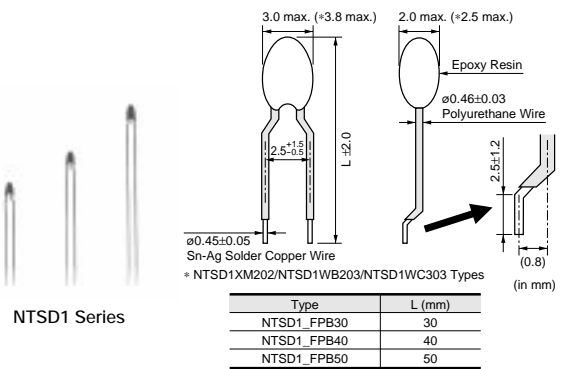
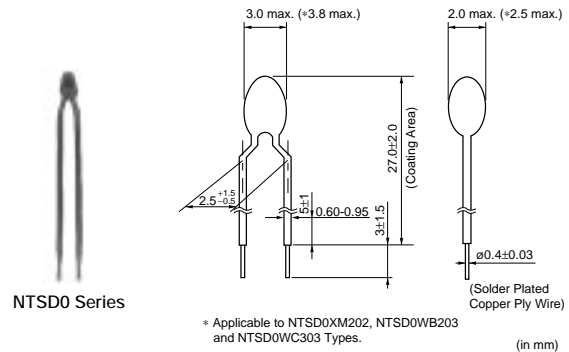

### NTSD0 Series

Part Number	Resistance (25°C) (ohm)	B-Constant (25-50°C) (K)	B-Constant (25-80°C) (Reference Value) (K)	B-Constant (25-85°C) (Reference Value) (K)	B-Constant (25-100°C) (Reference Value) (K)	Permissible Operating Current (25°C) (mA)	Rated Electric Power (25°C) (mW)	Typical Dissipation Constant (25°C) (mW/°C)	Thermal Time Constant (s)
NTSD0XM202□E1B0	2.0k	3500 $\pm 0.5\%$	3523	3526	3543	1.05	21	2.1	7
NTSD0XR502□E1B0	5.0k	3700 $\pm 1\%$	3727	3738	3760	0.68	15	1.5	7
NTSD0XH103□E1B0	10k	3380 $\pm 0.5\%$	3428	3434	3455	0.38	15	1.5	7
NTSD0XV103□E1B0	10k	3900 $\pm 0.5\%$	3930	3934	3944	0.46	15	1.5	7
NTSD0WB203□E1B0	20k	4050 $\pm 1\%$	4078	4080	4096	0.31	21	2.1	7
NTSD0WC303□E1B0	30k	4100 $\pm 1\%$	4128	4130	4147	0.26	21	2.1	7
NTSD0WD503□E1B0	50k	4150 $\pm 1\%$	4205	4213	4234	0.20	15	1.5	7
NTSD0WF104□E1B0	100k	4250 $\pm 1\%$	4303	4311	4334	0.14	15	1.5	7

A blank column is filled with resistance tolerance codes (F:  $\pm 1\%$ , E:  $\pm 3\%$ ).  
 Rated Electric Power is necessary electric power that Thermistor's temperature rises 10°C by self heating at 25°C in still air.  
 Operating Temperature Range: -40°C to +125°C

### NTSD1 Series

Part Number	Resistance (25°C) (ohm)	B-Constant (25-50°C) (K)	B-Constant (25-80°C) (Reference Value) (K)	B-Constant (25-85°C) (Reference Value) (K)	B-Constant (25-100°C) (Reference Value) (K)	Permissible Operating Current (25°C) (mA)	Rated Electric Power (25°C) (mW)	Typical Dissipation Constant (25°C) (mW/°C)	Thermal Time Constant (s)
NTSD1XM202FPB□□	2.0k $\pm 1\%$	3500 $\pm 0.5\%$	3523	3526	3543	1.05	21	2.1	7
NTSD1XR502FPB□□	5.0k $\pm 1\%$	3700 $\pm 1\%$	3727	3738	3760	0.68	15	1.5	7
NTSD1XH103FPB□□	10k $\pm 1\%$	3380 $\pm 0.5\%$	3428	3434	3455	0.38	15	1.5	7
NTSD1XV103FPB□□	10k $\pm 1\%$	3900 $\pm 0.5\%$	3930	3934	3944	0.46	15	1.5	7
NTSD1WB203FPB□□	20k $\pm 1\%$	4050 $\pm 1\%$	4078	4080	4096	0.31	21	2.1	7
NTSD1WC303FPB□□	30k $\pm 1\%$	4100 $\pm 1\%$	4128	4130	4147	0.26	21	2.1	7

Continued on the following page.

Continued from the preceding page.

Part Number	Resistance (25°C) (ohm)	B-Constant (25-50°C) (K)	B-Constant (25-80°C) (Reference Value) (K)	B-Constant (25-85°C) (Reference Value) (K)	B-Constant (25-100°C) (Reference Value) (K)	Permissible Operating Current (25°C) (mA)	Rated Electric Power (25°C) (mW)	Typical Dissipation Constant (25°C) (mW/°C)	Thermal Time Constant (s)
NTSD1WD503FPB□□	50k ±1%	4150 ±1%	4205	4213	4234	0.20	15	1.5	7
NTSD1WF104FPB□□	100k ±1%	4250 ±1%	4303	4311	4334	0.14	15	1.5	7

A blank column is filled with Total-length codes. (30, 40, 50)

Rated Electric Power is necessary electric power that Thermistor's temperature rises 10°C by self heating at 25°C in still air.

Operating Temperature Range: -40°C to +125°C

## Temperature Tolerance - Temperature Characteristics

Resistance Tolerance: +/-1% B-Constant Tolerance: +/-1%

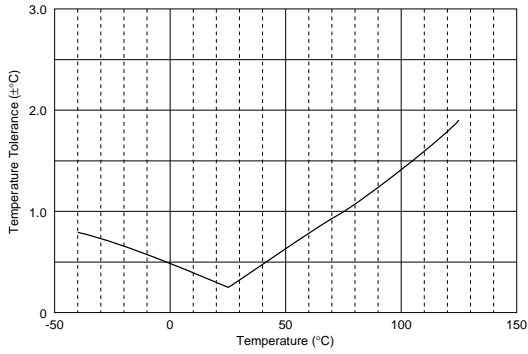

Resistance Tolerance: +/-1% B-Constant Tolerance: +/-0.5%

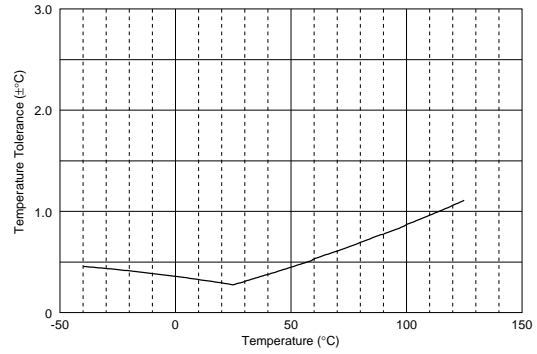



## for Temperature Sensor Temperature Characteristics (Center Value)

Part Number	NXF□XH103	NXF□WB473	NXF□WF104
Resistance	10kΩ	47kΩ	100kΩ
B-Constant	3380K	4050K	4250K
Temp. (°C)	Resistance (kΩ)	Resistance (kΩ)	Resistance (kΩ)
-40	197.388	1690.590	4221.280
-35	149.395	1215.320	2995.040
-30	114.345	882.908	2147.000
-25	88.381	647.911	1554.600
-20	68.915	480.069	1136.690
-15	54.166	359.009	839.019
-10	42.889	270.868	624.987
-5	34.196	206.113	469.678
0	27.445	158.126	355.975
5	22.165	122.267	272.011
10	18.010	95.256	209.489
15	14.720	74.754	162.559
20	12.099	59.075	127.057
25	10.000	47.000	100.000
30	8.309	37.636	79.222
35	6.939	30.326	63.167
40	5.824	24.583	50.677
45	4.911	20.043	40.904
50	4.160	16.433	33.195
55	3.539	13.545	27.091
60	3.024	11.223	22.224
65	2.593	9.345	18.323
70	2.233	7.818	15.184
75	1.929	6.571	12.635
80	1.673	5.548	10.566
85	1.455	4.704	8.873
90	1.270	4.004	7.481
95	1.112	3.422	6.337
100	0.976	2.936	5.384
105	0.860	2.528	4.594
110	0.759	2.184	3.934
115	0.673	1.893	3.380
120	0.598	1.646	2.916
125	0.532	1.436	2.522

Part Number	NTS□□XM202	NTS□□XR502	NTS□□XH103	NTS□□XV103	NTS□□WB203	NTS□□WC303	NTS□□WD503	NTS□□WF104
Resistance	2.0kΩ	5.0kΩ	10kΩ	10kΩ	20kΩ	30kΩ	50kΩ	100kΩ
B-Constant	3500K	3700K	3380K	3900K	4050K	4100K	4150K	4250K
Temp. (°C)	Resistance (kΩ)	Resistance (kΩ)	Resistance (kΩ)	Resistance (kΩ)	Resistance (kΩ)	Resistance (kΩ)	Resistance (kΩ)	Resistance (kΩ)
-40	44.657	123.484	195.652	347.808	733.007	1149.500	1948.575	4256.752
-35	33.505	92.295	148.171	248.591	524.831	819.651	1387.289	3005.888
-30	25.388	69.614	113.347	179.973	380.184	591.391	999.456	2148.514
-25	19.402	52.860	87.559	131.832	277.845	430.529	728.895	1555.020
-20	14.961	40.480	68.237	97.679	205.260	316.870	537.039	1137.312
-15	11.644	31.275	53.650	73.119	153.642	236.337	399.167	839.314
-10	9.133	24.339	42.506	55.301	116.016	177.842	299.469	625.338
-5	7.198	19.154	33.892	42.257	88.125	134.630	226.186	469.127
0	5.716	15.148	27.219	32.582	67.522	102.816	172.393	355.224
5	4.571	11.964	22.021	25.324	52.168	79.183	132.857	272.045
10	3.682	9.520	17.926	19.847	40.617	61.460	103.089	209.803
15	2.987	7.624	14.674	15.679	31.847	48.045	80.430	162.713
20	2.437	6.160	12.081	12.478	25.151	37.834	63.201	127.117
25	2.000	5.000	10.000	10.000	20.000	30.000	50.000	100.000
30	1.651	4.082	8.315	8.068	16.014	23.955	39.825	79.215
35	1.371	3.354	6.948	6.552	12.902	19.249	31.918	63.150
40	1.143	2.773	5.834	5.353	10.457	15.560	25.733	50.649
45	0.958	2.299	4.917	4.399	8.527	12.657	20.877	40.885
50	0.807	1.914	4.161	3.635	6.993	10.354	17.034	33.195
55	0.683	1.607	3.535	3.020	5.771	8.525	13.929	27.014
60	0.582	1.356	3.014	2.521	4.789	7.058	11.439	22.079
65	0.497	1.149	2.586	2.115	3.992	5.869	9.485	18.226
70	0.426	0.978	2.228	1.783	3.343	4.905	7.906	15.124
75	0.367	0.834	1.925	1.510	2.809	4.113	6.614	12.598
80	0.318	0.714	1.669	1.284	2.376	3.472	5.558	10.542
85	0.276	0.612	1.452	1.096	2.020	2.945	4.686	8.852
90	0.240	0.527	1.268	0.939	1.724	2.509	3.967	7.463
95	0.210	0.456	1.110	0.808	1.476	2.143	3.373	6.321
100	0.183	0.396	0.974	0.698	1.264	1.832	2.878	5.374
105	0.161	0.345	0.858	0.605	1.085	1.571	2.465	4.585
110	0.142	0.302	0.758	0.527	0.935	1.350	2.118	3.925
115	0.125	0.264	0.671	0.460	0.812	1.171	1.828	3.376
120	0.111	0.232	0.596	0.403	0.708	1.019	1.583	2.913
125	0.099	0.205	0.531	0.354	0.617	0.886	1.374	2.520

Detailed Resistance - Temperature Tables are downloadable from the following URL.  
<http://search.murata.co.jp/Ceramy/CatsearchAction.do?sLang=en>

## for Temperature Sensor Thermo String Type/Lead Type ⚠Caution/Notice

### ■ ⚠Caution (Storage and Operating Conditions)

This product is designed for application in an ordinary environment (normal room temperature, humidity and atmospheric pressure).

Do not use under the following conditions because all these factors can deteriorate the product characteristics or cause failures and burn-out.

1. Corrosive gas or deoxidizing gas  
(Chlorine gas, Hydrogen sulfide gas, Ammonia gas, Sulfuric acid gas, Nitric oxide gas, etc.)
2. Volatile or flammable gas
3. Dusty conditions
4. Under vacuum, or under high or low-pressure
5. Wet or humid locations
6. Places with salt water, oils, chemical liquids or organic solvents
7. Strong vibrations
8. Other places where similar hazardous conditions exist

### ■ ⚠Caution (Others)

Be sure to provide an appropriate fail-safe function on your product to prevent secondary damages that may be caused by the abnormal function or the failure of our product.

### ■ Notice (Storage and Operating Conditions)

To keep solderability of product from declining, the following storage condition is recommended.

1. Storage condition:  
Temperature -10 to +40 degrees C  
Humidity less than 75%RH (not dewing condition)
2. Storage term:  
Use this product within 6 months after delivery by first-in and first-out stocking system.
3. Handling after unpacking:  
After unpacking, reseal product promptly or store it in a sealed container with a drying agent.
4. Storage place:  
Do not store this product in corrosive gas (Sulfuric acid gas, Chlorine gas, etc.) or in direct sunlight.

### ■ Notice (Rating)

Use this product within the specified temperature range.

Higher temperature may cause deterioration of the characteristics or the material quality of this product.

### ■ Notice (Soldering and Mounting) NTS Series

1. Be sure that the preheat-up does not melt the soldering of this product. Excessive heat may cause failure to open, short or insulation break down.
2. Do not touch the body with soldering iron.  
The soldering point should be min. 5mm away from the root of lead wire.

## for Temperature Sensor Thermo String Type/Lead Type ⚠Caution/Notice

### ■ Notice (Soldering and Mounting) NXF Series

Please notice as shown below when you mount this product.

1. Do not melt the solder in resin head, when you solder this product. If you melt the solder in resin head, it has possibility that the break of wire, short and break of lead insulation. In case you cut the lead wire of this product less than 20mm from resin head, the heat of melted solder at lead wire edge is propagated easily to the resin head along the lead wire.
2. Do not touch the resin head directly by solder iron. It may cause the melt of solder in resin head.
3. Do not separate the parallel lead wires 10mm or less from the resin head, when you separate parallel lead wires.
4. If you mold by resin this product, please evaluate the quality of this product before you use it.
5. Do not bend the lead wire radius 1mm or less when you bend the lead wire.

### ■ Notice (Handling)

1. The ceramic element of this product is fragile, and care must be taken not to load an excessive press-force or not to give a shock at handling. Such forces may cause cracking or chipping.
2. Do not apply an excessive force to the lead. Otherwise, it may cause junction between lead and element to break or crack. Holding element by side lead wire is recommended when lead wire is bent or cut.

## for Temperature Sensor Thermo String Type/Lead Type Package

### ■ Minimum Quantity

Part Number	Minimum Quantity (pcs.)	
	Bulk	Ammo Pack Taping
<b>NXF</b>	1000	-
<b>NTSA</b>	500	3000
<b>NTSD0</b>	500	-
<b>NTSD1_30</b>	500	-
<b>NTSD1_40</b>	200	-
<b>NTSD1_50</b>	200	-

### ■ Taping Dimensions (NTSA\_N6A0 Series)

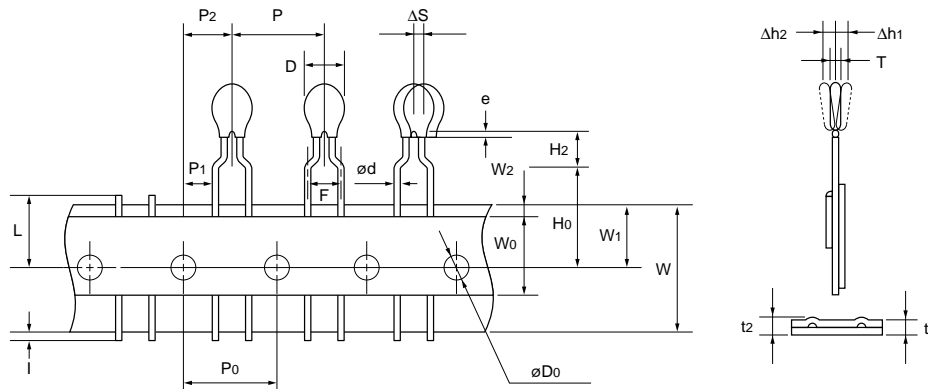

Item	Code	Dimensions (mm)
Pitch of Component	P	12.7
Pitch of Sprocket Hole	P <sub>0</sub>	12.7±0.3
Lead Spacing	F	5.0+0.8/-0.2
Length from Hole Center to Component Center	P <sub>2</sub>	6.35±1.3
Length from Hole Center to Lead	P <sub>1</sub>	3.85±0.8
Body Diameter	D	3.5 max.
Deviation along Tape, Left or Right	ΔS	0±2.0
Carrier Tape Width	W	18.0±0.5
Position of Sprocket Hole	W <sub>1</sub>	9.0±0.5
Lead Distance between Reference and Bottom Planes	H <sub>0</sub>	16.0±1.0
Height of Component	H <sub>2</sub>	4.0 max.
Protrusion Length	l	+0.5 to -1.0
Diameter of Sprocket Hole	D <sub>0</sub>	4.0±0.1
Lead Diameter	d	0.50±0.03
Total Tape Thickness	t <sub>1</sub>	0.6±0.3
Total Thickness, Tape and Lead Wire	t <sub>2</sub>	1.6 max.
Deviation across Tape	Δh <sub>1</sub> , Δh <sub>2</sub>	1.0 max.
Portion to Cut in Case of Defect	L	11.0+0/-2.0
Hole Down Tape Width	W <sub>0</sub>	11.0 min.
Hole Down Tape Position	W <sub>2</sub>	1.5±1.5
Coating Extension on Lead	e	Up to the crimp point
Body Thickness	T	2.6 max.

(in mm)

# NTC Thermistors



## for Inrush Current Suppression Lead Type

This product effectively suppresses surge currents which are generated when switching power regulators are turned on.

### ■ Features

1. Lead is not contained in the ceramic element, the terminations, the solder for inner connection and the coating resin.
2. Most suitable for power supplies of less than 100W
3. Excellent recovery characteristics due to resin coating with excellent heat characteristics
4. Highly reliable

### ■ Applications

1. Switching power supplies
2. CRT monitors
3. Color televisions
4. VCR-Power supplies
5. Other power circuits



NTPAN/NTPAJ Series

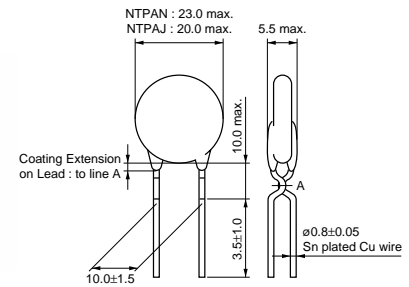

(in mm)



NTPAD/NTPAA Series

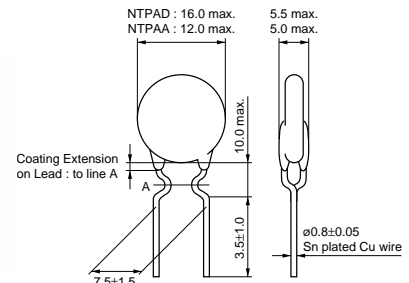

(in mm)



NTPA7/NTPA9 Series

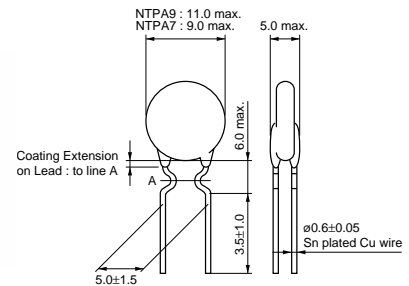

(in mm)

Part Number	Resistance (25°C) (ohm)	Permissible Max. Current (25°C) (A)	Permissible Max. Current (55°C) (A)	Thermal Time Constant (25°C) (s)	Thermal Dissipation Constant (25°C) (mW/°C)
NTPAN3R0LDKB0	3.0 ±15%	5.4	4.7	135	26.8
NTPAN4R0LDKB0	4.0 ±15%	4.7	4.1	130	26.8
NTPAN6R0LDKB0	6.0 ±15%	3.9	3.4	130	26.8
NTPAJ4R0LDKB0	4.0 ±15%	4.0	3.5	125	21.8
NTPAJ6R0LDKB0	6.0 ±15%	3.4	2.9	125	21.8
NTPAJ8R0LDKB0	8.0 ±15%	3.0	2.6	130	21.8
NTPAJ100LDKB0	10.0 ±15%	2.6	2.2	130	21.8
NTPAD3R9LDNB0	3.9 ±15%	3.3	2.9	65	18.2
NTPAD5R1LDNB0	5.1 ±15%	3.0	2.6	85	18.8
NTPAD8R0LDNB0	8.0 ±15%	2.7	2.3	65	18.7
NTPAD160LDNB0	16.0 ±15%	2.0	1.7	100	19.1
NTPAA2R2LDNB0	2.2 ±15%	3.7	3.2	70	13.5

Continued on the following page.

Continued from the preceding page.

Part Number	Resistance (25°C) (ohm)	Permissible Max. Current (25°C) (A)	Permissible Max. Current (55°C) (A)	Thermal Time Constant (25°C) (s)	Thermal Dissipation Constant (25°C) (mW/°C)
NTPAA3R9LDNB0	3.9 ±15%	2.7	2.3	70	13.5
NTPAA5R1LDNB0	5.1 ±15%	2.5	2.2	70	13.5
NTPAA8R2LDNB0	8.2 ±15%	2.0	1.7	70	13.5
NTPAA100LDNB0	10.0 ±15%	1.7	1.5	70	13.5
NTPA9160LBMB0	16.0 ±15%	1.4	1.2	65	11.6
NTPA74R0LBMB0	4.0 ±15%	2.3	2.0	40	9.4
NTPA78R0LBMB0	8.0 ±15%	1.7	1.5	40	9.5
NTPA7160LBMB0	16.0 ±15%	1.2	1.0	40	9.9
NTPA7220LBMB0	22.0 ±15%	1.0	0.88	40	9.1

NTPAD/NTPAA/NTPA9/NTPA7 series are also available on tape. The final alphabet of the part number should be "DNB0=>D6A0", "BNB0 =>B1A0".  
 Operating Temperature Range: -20°C to +160°C

### ■ Permissible Electrolytic Capacitor

Part Number	Voltage (AC)					
	100Vrms	120Vrms	132Vrms	220Vrms	240Vrms	264Vrms
NTPAN	8600μF	5972μF	4936μF	1777μF	1493μF	1234μF
NTPAJ	5000μF	3472μF	2870μF	1033μF	868μF	717μF
NTPAD	2700μF	1875μF	1550μF	558μF	469μF	387μF
NTPAA	1400μF	972μF	803μF	289μF	243μF	201μF
NTPA9	800μF	556μF	459μF	165μF	139μF	115μF
NTPA74R0	700μF	486μF	402μF	145μF	122μF	100μF
NTPA78R0	570μF	396μF	327μF	118μF	99μF	82μF
NTPA7160	400μF	278μF	230μF	83μF	69μF	57μF
NTPA7220						

### ■ Application Circuit

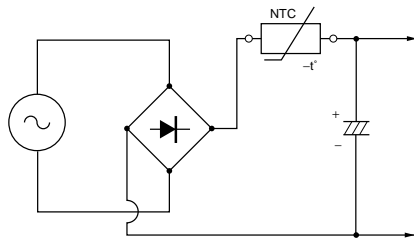

### ■ Determination of Allowable Current

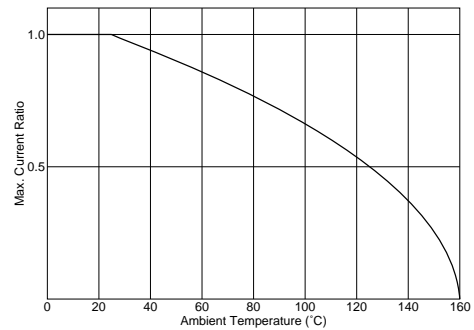

## Current - R Ratio (RT/R25)/Current - Temperature Characteristics (Typical)

### ■ NTPAN3R0L Type

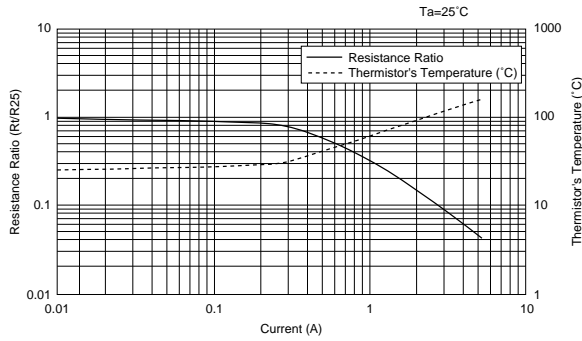

### ■ NTPAN4R0L Type

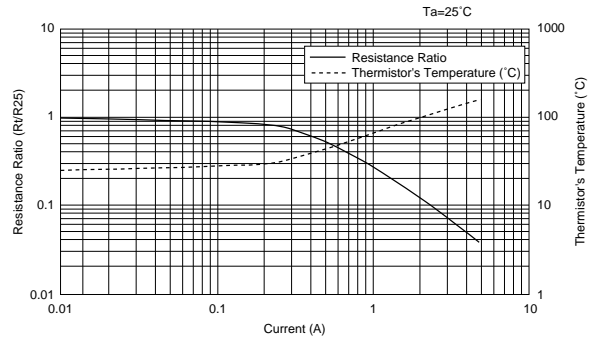

### ■ NTPAN6R0L Type

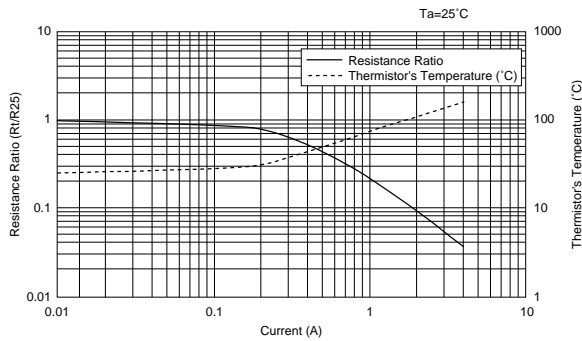

### ■ NTPAJ4R0L Type

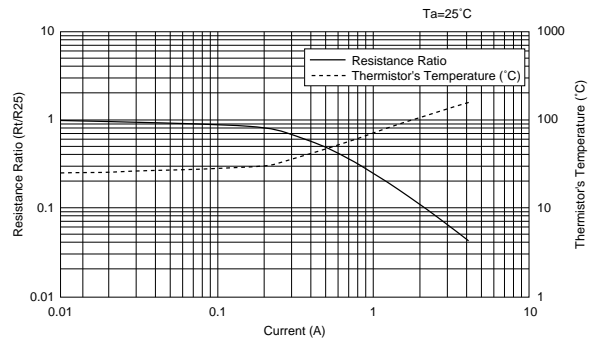

### ■ NTPAJ6R0L Type

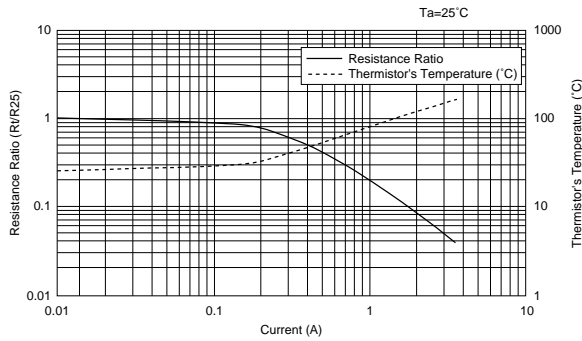

### ■ NTPAJ8R0L Type

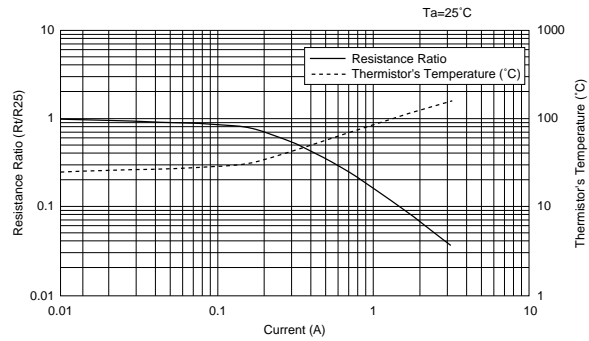

Continued on the following page. ↗

## Current - R Ratio (RT/R25)/Current - Temperature Characteristics (Typical)

Continued from the preceding page.

### ■ NTPAJ100L Type

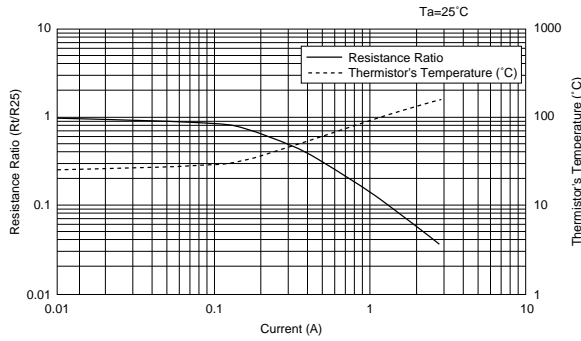

### ■ NTPAD3R9L Type

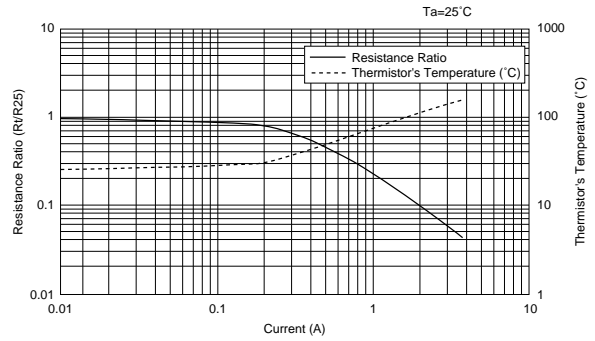

### ■ NTPAD5R1L Type

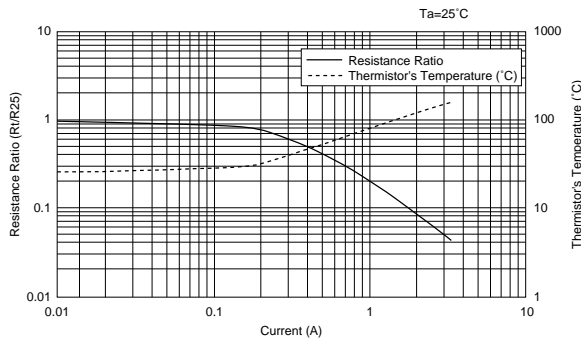

### ■ NTPAD8R0L Type

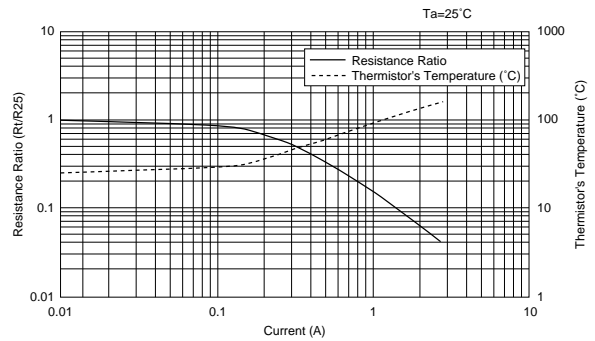

### ■ NTPAD160L Type

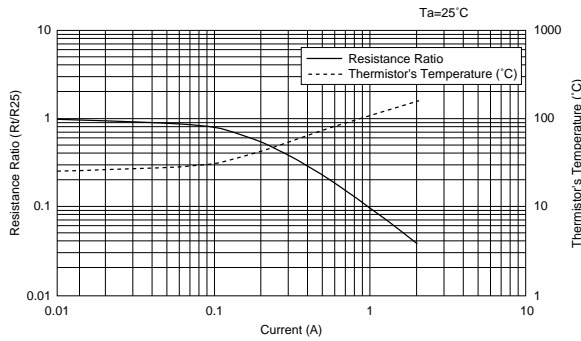

### ■ NTPAA2R2L Type

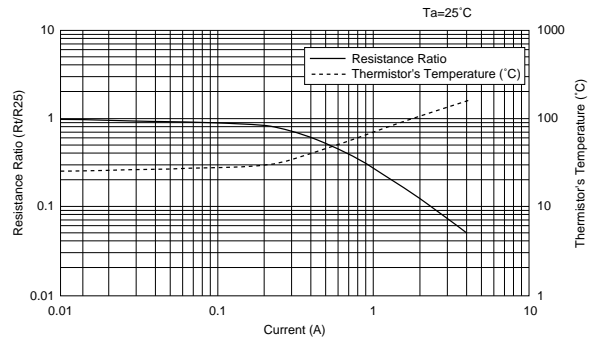

Continued on the following page. ↗



## Current - R Ratio (RT/R25)/Current - Temperature Characteristics (Typical)

Continued from the preceding page.

### ■ NTPAA3R9L Type

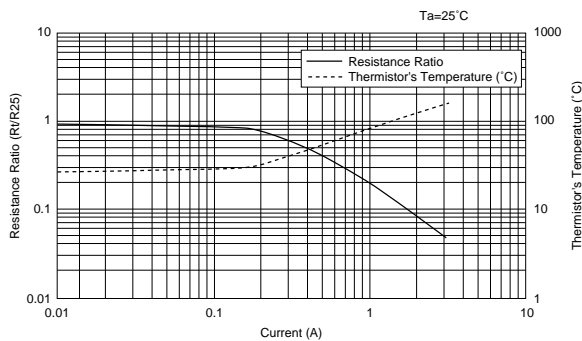

### ■ NTPAA5R1L Type

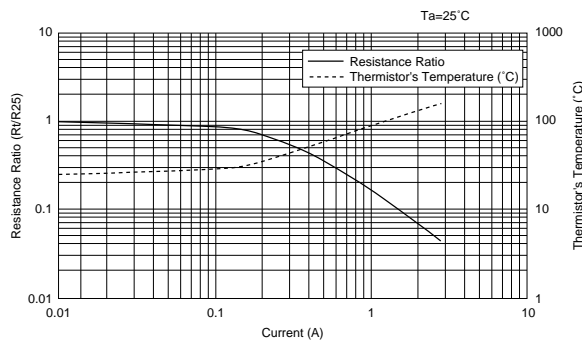

### ■ NTPAA8R2L Type

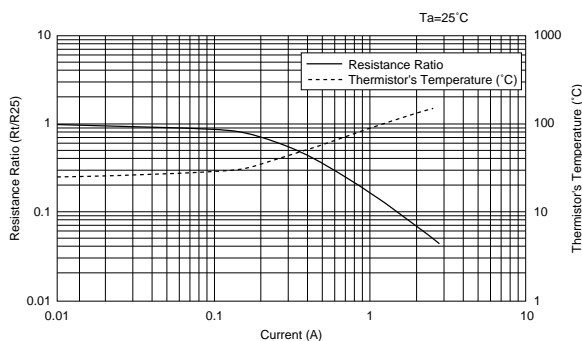

### ■ NTPAA100L Type

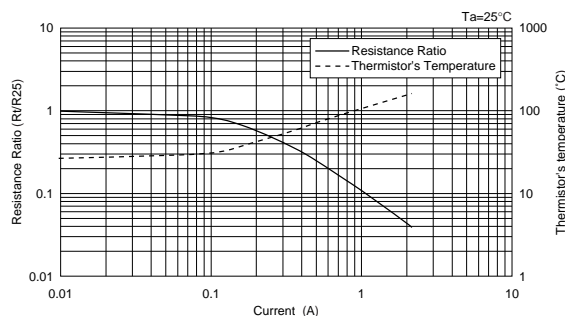

### ■ NTPA9160L Type

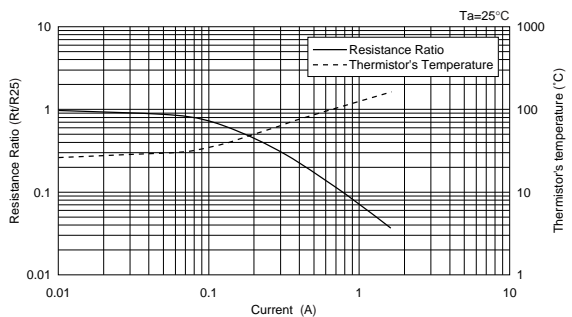

### ■ NTPA74R0L Type

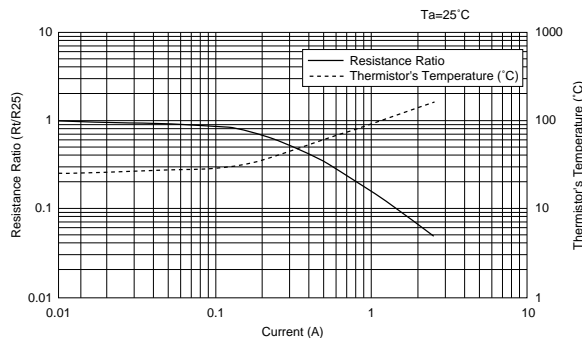

Continued on the following page. ↗

## Current - R Ratio (RT/R25)/Current - Temperature Characteristics (Typical)

Continued from the preceding page.

### ■ NTPA78R0L Type

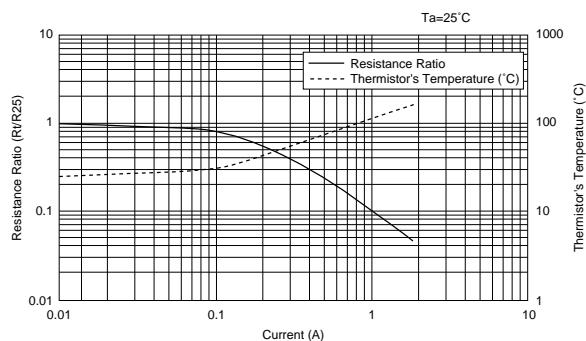

### ■ NTPA7160L Type

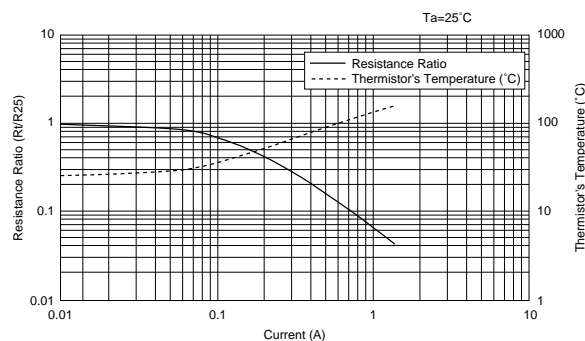

### ■ NTPA7220L Type

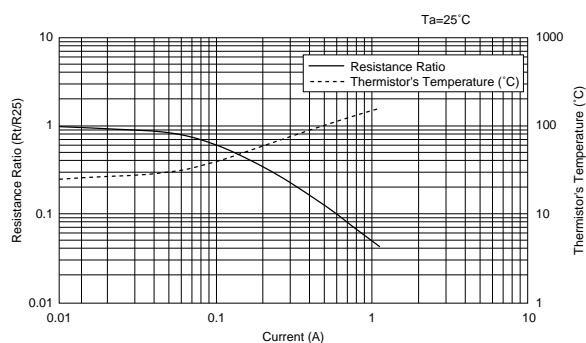

## for Inrush Current Suppression Lead Type ⚠Caution/Notice

### ■ ⚠Caution (Storage and Operating Conditions)

1. This product is designed for the Switching Power Supply with smoothing capacitors.  
Other applications of this product may result in fire.
2. Use this product within the specified maximum current. Otherwise it may catch fire in the worst case.
3. Use this product with smoothing capacitor within the specified maximum capacitance value. Otherwise it may catch fire in the worst case.
4. This product is designed for application in an ordinary environment (normal room temperature, humidity and atmospheric pressure).  
Do not use under the following conditions because all these factors can deteriorate the product characteristics cause failure and burn-out.
  - (1) Corrosive gas or deoxidizing gas.  
(Chlorine gas, Hydrogen sulfide gas, Ammonia gas, Sulfuric acid gas, Nitric oxide gas, etc.)
  - (2) Volatile or flammable gas
  - (3) Dusty conditions
  - (4) Under high or low pressure
  - (5) Wet or humid conditions
  - (6) Near with salt water, oils, chemical liquids or organic solvents
  - (7) Strong vibrations
  - (8) Other places where similar hazardous conditions exist.

### ■ ⚠Caution (Others)

Be sure to provide an appropriate fail-safe function on your product to prevent secondary damages that may be caused by the abnormal function or the failure of our product.

### ■ Notice (Storage and Operating Conditions)

To keep solderability of product from declining, the following storage condition is recommended.

1. Storage condition:  
Temperature -10 to +40 degrees C  
Humidity less than 75%RH (not dewing condition)
2. Storage term:  
Use this product within 6 months after delivery by first-in and first-out stocking system.
3. Handling after unpacking:  
After unpacking, reseal product promptly or store it in a sealed container with a drying agent.
4. Storage place:  
Do not store this product in corrosive gas (Sulfuric acid gas, Chlorine gas, etc.) or in direct sunlight.

### ■ Notice (Rating)

Use this product within the specified temperature range.  
Higher temperature may cause deterioration of the characteristics or the material quality of this product.

### ■ Notice (Soldering and Mounting)

1. Be sure that the preheat-up does not melt the soldering of this product. Excessive heat may cause failure to open, short or insulation break down.
2. Do not touch the body with soldering iron.  
The soldering point should be min. 5mm away from the root of lead wire.

## for Inrush Current Suppression Lead Type ⚠Caution/Notice

### ■ Notice (Handling)

1. When this product is operated, temperature of some area may be about 160 (degree C).  
Use proper surrounding parts and material which withstand such temperature. If they are inadequate and kept at high temperature for long time, they may be deteriorated or may produce harmful gas. And, such harmful gas may deteriorate the element of this product.
2. This product does not have waterproof construction. Splashed water may cause failure mode such as deterioration of characteristics or current leak. So, do not apply cleaning to immerse it into water or any solvent.
3. The ceramic element of this product is fragile, and care must be taken not to load an excessive press-force or not to give a shock at handling. Such forces may cause cracking or chipping to the element.
4. Do not apply an excessive force to the lead wire. Otherwise, it may cause break off junction between lead wire and element, or may crack element. So, fix lead wire of element side when lead wire is bent or cut.

### ■ Notice (Others)

1. This product may allow passing higher current than its initial value when it receives inrush current again just after the last one until it cools down and recovers its original resistance enough. Be sure the highest current under actual condition on the operating repetition and the operating temperature.
2. The resin coating of this product does not guarantee insulating. Keep an adequate insulating distance to surrounding parts.

## for Inrush Current Suppression Lead Type Package

### ■ Minimum Quantity

Part Numbers	Minimum Quantity (pcs.)	
	Bulk	Ammo Pack Taping
<b>NTPA7</b>	500	1000
<b>NTPA9</b>	300	1000
<b>NTPAA</b>	300	750
<b>NTPAD</b>	150	400
<b>NTPAJ</b>	100	-
<b>NTPAN</b>	50	-

### ■ Taping Dimensions (NTPAD/NTPAA\_D6A0 Series)

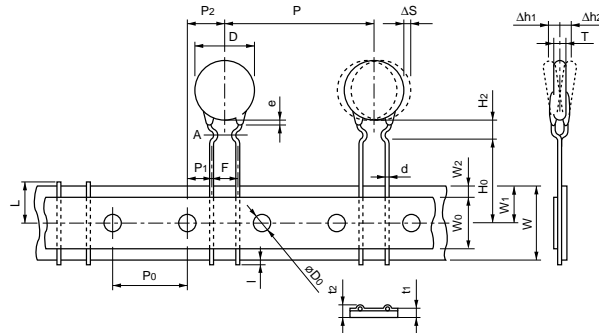

Item	Code	Dimensions (mm)
Pitch of Component	P	30.0
Pitch of Sprocket Hole	P <sub>0</sub>	15.0±0.3
Lead Spacing	F	7.5±0.5
Length from Hole Center to Component Center	P <sub>2</sub>	7.5±1.5
Length from Hole Center to Lead	P <sub>1</sub>	3.75±1.0
Body Diameter	D	(refer to the table below)
Body Thickness	T	(refer to the table below)
Deviation Along Tape, Left or Right	ΔS	±2.0
Carrier Tape Width	W	18.0±0.5
Position of Sprocket Hole	W <sub>1</sub>	9.0±0.5
Lead Distance between Reference and Bottom Plane	H <sub>0</sub>	16.0±0.5
Height of Component	H <sub>2</sub>	10.0 max.
Protrusion Length	l	+0.5 to -6.0
Diameter of Sprocket Hole	D <sub>0</sub>	4.0±0.1
Lead Diameter	d	0.8±0.05
Total Tape Thickness	t <sub>1</sub>	0.6±0.3
Total Thickness, Tape and Lead Wire	t <sub>2</sub>	2.0 max.
Deviation Across Tape	Δh <sub>1</sub> , Δh <sub>2</sub>	2.0 max.
Portion to Cut in Case of Defect	L	11.0 <sup>+0</sup> <sub>-2.0</sub>
Hold Down Tape Width	W <sub>0</sub>	11.5 min.
Hold Down Tape Position	W <sub>2</sub>	4.0 max.
Coating Extension on Lead	e	to line A

Type	D (mm)	T (mm)
<b>NTPAD</b>	16.0 max.	5.5 max.
<b>NTPAA</b>	12.0 max.	5.0 max.

Continued on the following page.

## for Inrush Current Suppression Lead Type Package

Continued from the preceding page.

### Taping Dimensions (NTPA9/NTPA7\_B1A0 Series)

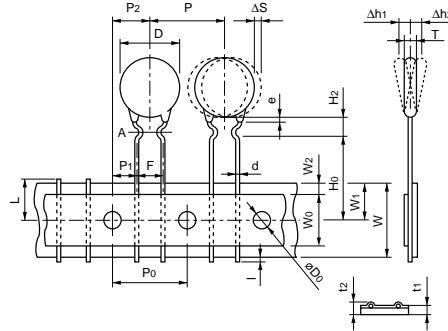

Item	Code	Dimensions (mm)
Pitch of Component	P	12.7
Pitch of Sprocket Hole	P <sub>0</sub>	12.7±0.3
Lead Spacing	F	5.0 <sup>+0.8</sup> <sub>-0.3</sub>
Length from Hole Center to Component Center	P <sub>2</sub>	6.35±1.3
Length from Hole Center to Lead	P <sub>1</sub>	3.85±0.8
Body Diameter	D	(refer to the table below)
Body Thickness	T	5.0 max.
Deviation Along Tape, Left or Right	ΔS	±1.5
Carrier Tape Width	W	18.0±0.5
Position of Sprocket Hole	W <sub>1</sub>	9.0 <sup>+0.5</sup> <sub>-0.75</sub>
Lead Distance between Reference and Bottom Planes	H <sub>0</sub>	16.0±1.0
Height of Component	H <sub>2</sub>	6.0 max.
Protrusion Length	l	+0.5 to -4.0
Diameter of Sprocket Hole	D <sub>0</sub>	4.0±0.3
Lead Diameter	d	0.6±0.05
Total Tape Thickness	t <sub>1</sub>	0.6±0.3
Total Thickness, Tape and Lead Wire	t <sub>2</sub>	2.0 max.
Deviation Across Tape	Δh <sub>1</sub> , Δh <sub>2</sub>	1.5 max.
Portion to Cut in Case of Defect	L	11.0 <sup>+0</sup> <sub>-2.0</sub>
Hold Down Tape Width	W <sub>0</sub>	11.0 min.
Hold Down Tape Position	W <sub>2</sub>	4.0 max.
Coating Extension on Lead	e	to line A

Type	D (mm)
<b>NTPA9</b>	11.0 max.
<b>NTPA7</b>	9.0 max.

**⚠Note:**

1. Export Control

<For customers outside Japan>

No Murata products should be used or sold, through any channels, for use in the design, development, production, utilization, maintenance or operation of, or otherwise contribution to (1) any weapons (Weapons of Mass Destruction [nuclear, chemical or biological weapons or missiles] or conventional weapons) or (2) goods or systems specially designed or intended for military end-use or utilization by military end-users.

<For customers in Japan>

For products which are controlled items subject to the "Foreign Exchange and Foreign Trade Law" of Japan, the export license specified by the law is required for export.

2. Please contact our sales representatives or product engineers before using the products in this catalog for the applications listed below, which require especially high reliability for the prevention of defects which might directly damage a third party's life, body or property, or when one of our products is intended for use in applications other than those specified in this catalog.

- |                             |  |
|-----------------------------|--|
| ① Aircraft equipment        | ② Aerospace equipment  |
| ③ Undersea equipment        | ④ Power plant equipment  |
| ⑤ Medical equipment         | ⑥ Transportation equipment (vehicles, trains, ships, etc.)   |
| ⑦ Traffic signal equipment  | ⑧ Disaster prevention / crime prevention equipment   |
| ⑨ Data-processing equipment | ⑩ Application of similar complexity and/or reliability requirements to the applications listed above |

3. Product specifications in this catalog are as of January 2010. They are subject to change or our products in it may be discontinued without advance notice. Please check with our sales representatives or product engineers before ordering. If there are any questions, please contact our sales representatives or product engineers.

4. Please read rating and ⚠ CAUTION (for storage, operating, rating, soldering, mounting and handling) in this catalog to prevent smoking and/or burning, etc.

5. This catalog has only typical specifications because there is no space for detailed specifications. Therefore, please approve our product specifications or transact the approval sheet for product specifications before ordering.

6. Please note that unless otherwise specified, we shall assume no responsibility whatsoever for any conflict or dispute that may occur in connection with the effect of our and/or a third party's intellectual property rights and other related rights in consideration of your use of our products and/or information described or contained in our catalogs. In this connection, no representation shall be made to the effect that any third parties are authorized to use the rights mentioned above under licenses without our consent.

7. No ozone depleting substances (ODS) under the Montreal Protocol are used in our manufacturing process.

---

***murata* Murata Manufacturing Co., Ltd.**

<http://www.murata.com/>

**Head Office**  
1-10-1, Higashi Kotari, Nagaokakyo-shi, Kyoto 617-8555, Japan  
Phone: 81-75-951-9111

**International Division**  
3-29-12, Shibuya, Shibuya-ku, Tokyo 150-0002, Japan  
Phone: 81-3-5469-6123 Fax: 81-3-5469-6155 E-mail: [intl@murata.co.jp](mailto:intl@murata.co.jp)