

PBF-SERIES

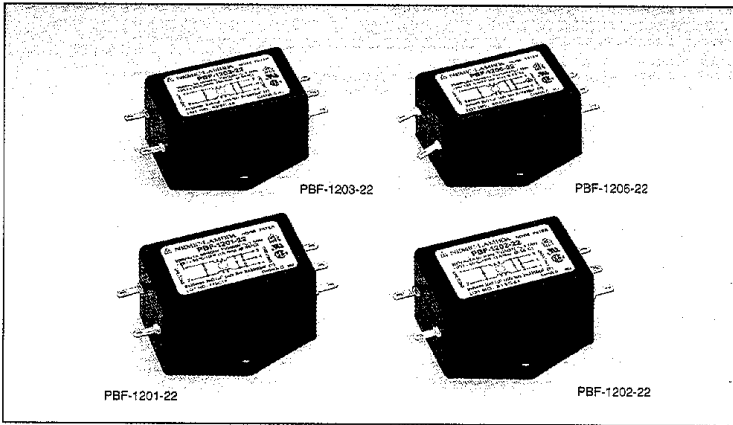

Features

- (1) For equipment designed to conform EMI regulations such as VCCI, CISPR, FCC, VDE, etc.
- (2) Attenuates conductive emission from power supply
- (3) Leakage current: 0.75mA max. (250V, 60Hz)
- (4) Compact package
- (5) Simple wiring and easy maintenance by fast-on tab
- (6) Low price

Safety standard

- UL1283, CSA Std. C22. 2 No. 8
- VDE0565 Teil. 3
- (VDE0565 will transfer to EN133200 on and after July 23, 2003.)

Specifications

Item	Model	PBF-1201-22	PBF-1202-22	PBF-1203-22	PBF-1206-22
1	Rated voltage (AC, DC)	250V			
2	Rated current (AC, DC) (Note)	1A	2A	3A	6A
3	Test voltage (terminal to case, AC 1 minute)	2500V			
4	Isolation resistance (terminal to case, 500VDC)	100MΩ min.			
5	Leakage current	0.35mA max.			
		0.75mA max.			
6	DC resistance	1.2Ω max.	0.4Ω max.	0.2Ω max.	0.07Ω max.
7	Temperature rise	30°C max.			
8	Operating temperature range	-25 ~ +85°C			
9	Weight (typ)	50g			

(Note) : Value at Ta ≤ 55°C. Refer to the derating curve shown below at Ta > 55°C.

Circuit

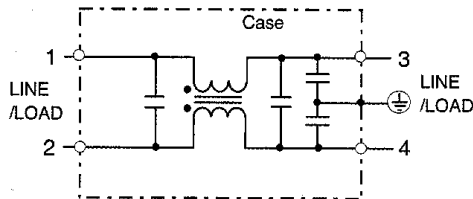

Derating

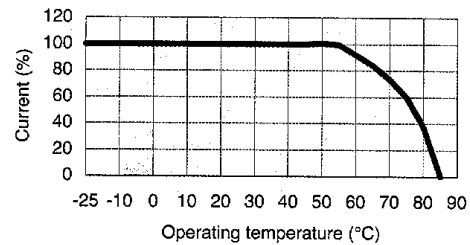

Outline drawings

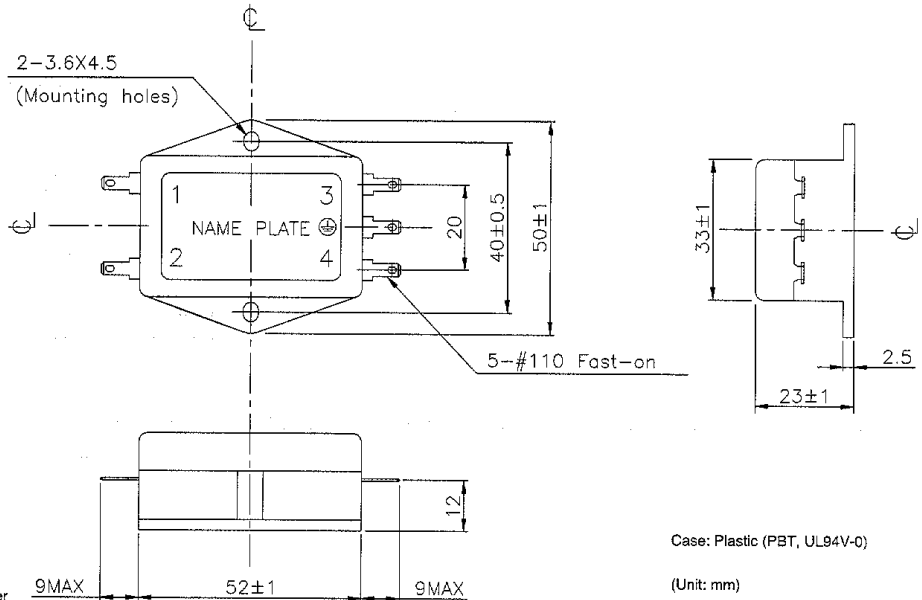

- Request customer specification for further details of specifications, outline, characteristics, etc.
- Read the instruction manual before usage.
- Contact us about delivery before ordering.

Noise Filter

CHARACTERISTICS

Typical Insertion Loss Symmetrical
 Asymmetrical

PBF-1201

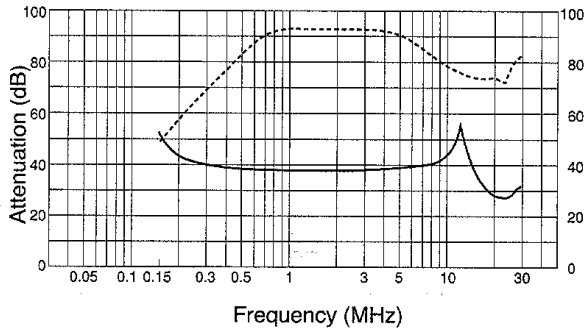

PBF-1202

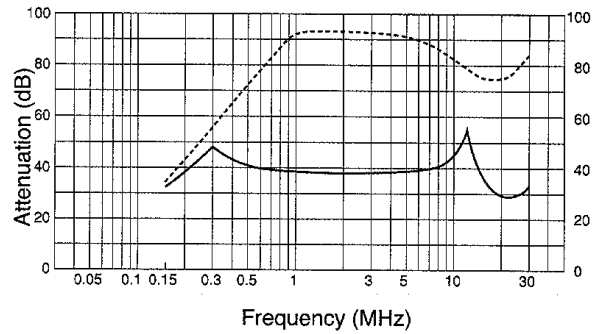

PBF-1203

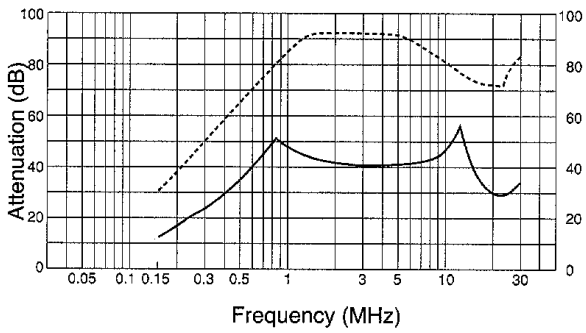

PBF-1206

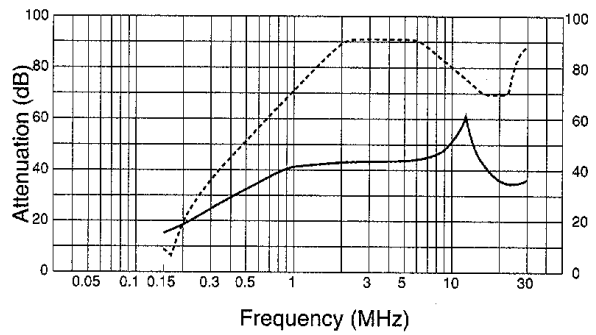

Noise Filter