

SIFI-B for enhanced insertion loss
Rated voltage 250 V~, 50/60 Hz
Rated current 1 A to 20 A
Construction

- Two-line filter
- Metal case
- Polyurethane potting (UL 94 V-0)

Features

- Compact design
- Low leakage current
- All relevant approvals
- Cost-optimized construction
- Also for assembly on top-hat rails

Applications

- Switch-mode power supplies in
 - industrial electronics
 - telecommunications
 - data systems
 - medical engineering

Case styles and terminal styles

- | | |
|--------------|--|
| Case style A | Tab connectors on face ends, lateral mounting tabs.
Particularly suitable for mounting on a shielding wall. |
| Case style B | Tab connectors on face ends, mounting tabs on face ends. |
| Case style K | IEC connector as per IEC 60320 C 14 on line side,
tab connectors on load side, mounting holes with metric thread. |
| Case style L | Litz wires on face ends |
| Case style P | Pins fitting PCB standard grid |

Marking

Marking on component:



 Manufacturer's logo, ordering code,
rated voltage, rated current,
date code

Minimum marking on packaging:

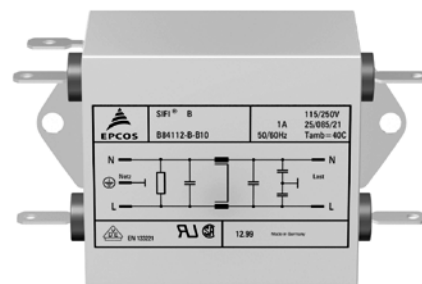
Manufacturer's logo, ordering code

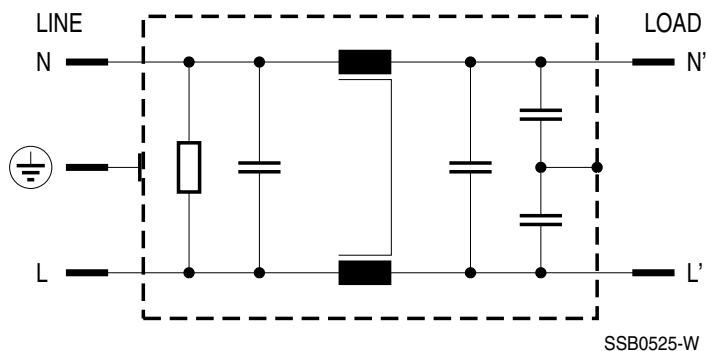

Circuit diagram

Technical data

Rated voltage V_R	250 V~, 50/60 Hz
Rated current I_R	Referred to 40 °C ambient temperature
Test voltage V_P	1414 V-, 2 s (line/line) 2700 V-, 2 s (lines/case)
Leakage current I_{leak}	< 0,5 mA at 230 V~, 50 Hz
Discharge resistors	The discharge resistors are rated such that one second after having disconnected the device from the power line, the voltage at the line connector should have dropped to 34 V.
Climatic category	In accordance with EN 60068-1 25/085/21 (- 25 °C/+ 85 °C/21 days damp heat test)
Approvals	 EN 133221  

Characteristics and ordering codes

I_R A	C_R	L_R	Case style	Appr. weight g	Ordering code	Mounting plate for top-hat rail (ordering code)
1	2 × 0,15 μF (X2) + 2 × 4700 pF (Y2)	2 × 10 mH	A	110	B84112-B-A10	—
			B	110	B84112-B-B10	C62122-A132-B91
			K	140	B84112-B-K10	—
			L	110	B84112-B-L10	—
2	2 × 0,15 μF (X2) + 2 × 4700 pF (Y2)	2 × 10 mH	A	110	B84112-B-A20	—
			B	110	B84112-B-B20	C62122-A132-B91
			L	110	B84112-B-L20	—
3	2 × 0,22 μF (X2) + 2 × 4700 pF (Y2)	2 × 10 mH	A	140	B84112-B-A30	—
			B	140	B84112-B-B30	C62122-A132-B92
			K	210	B84112-B-K30	—
			L	140	B84112-B-L30	—
			P	140	B84112-B-P30	—
6	2 × 0,33 μF (X2) + 2 × 4700 pF (Y2)	2 × 3,3 mH	A	150	B84112-B-A60	—
			B	150	B84112-B-B60	C62122-A132-B92
			K	210	B84112-B-K60	—
			L	150	B84112-B-L60	—
10	2 × 0,47 μF (X2) + 2 × 4700 pF (Y2)	2 × 1,8 mH	A	200	B84112-B-A110	—
			B	200	B84112-B-B110	C62122-A132-B92
			L	200	B84112-B-L110	—
20	2 × 0,68 μF (X2) + 2 × 4700 pF (Y2)	2 × 1,8 mH	A	700	B84112-B-A120	—
			B	700	B84112-B-B120	C62122-A132-B92

Case styles and dimensions

Case style	Ordering code B84112-	Dimensions in mm											
		b_1	b_2	b_3	b_4	l_1	l_2	l_3	l_4	h_1	h_2	Litz mm ²	Style 1015
A	-B-A10	45	26,5	60,4	70	50	—	—	76,5	28,6	20	—	—
B	-B-B10	45	26,5	—	—	50	60,4	70	76,5	28,6	20	—	—
K	-B-K10	51	—	—	—	63,5	—	—	—	32	—	—	—
L	-B-L10	45	—	—	—	50	60,4	70	—	28,6	—	0,82	AWG18
A	-B-A20	45	26,5	60,4	70	50	—	—	76,5	28,6	20	—	—
B	-B-B20	45	26,5	—	—	50	60,4	70	76,5	28,6	20	—	—
L	-B-L20	45	—	—	—	50	60,4	70	—	28,6	—	0,82	AWG18
A	-B-A30	50,8	31,5	60,4	70	63,5	—	—	89,5	28,6	20	—	—
B	-B-B30	50,8	31,5	—	—	63,5	74,7	84,5	89,5	28,6	20	—	—
K	-B-K30	50,8	—	—	—	79,5	—	—	—	32	—	—	—
L	-B-L30	50,8	—	—	—	63,5	74,7	84,5	—	28,6	—	0,82	AWG18
P	-B-P30	see dimensional drawing											
A	-B-A60	50,8	31,5	60,4	70	63,5	—	—	89,5	28,6	20	—	—
B	-B-B60	50,8	31,5	—	—	63,5	74,7	84,5	89,5	28,6	20	—	—
K	-B-K60	50,8	—	—	—	79,5	—	—	—	32	—	—	—
L	-B-L60	50,8	—	—	—	63,5	74,7	84,5	—	28,6	—	0,82	AWG18
A	-B-A110	50,8	31,5	60,4	70	63,5	—	—	89,5	38,1	28	—	—
B	-B-B110	50,8	31,5	—	—	63,5	74,7	84,5	89,5	38,1	28	—	—
L	-B-L110	50,8	—	—	—	63,5	74,7	84,5	—	38,1	—	1,35	AWG16
A	-B-A120	see dimensional drawing											
B	-B-B120	see dimensional drawing											

Case style A

B84112-B-A10 ...
B84112-B-A110

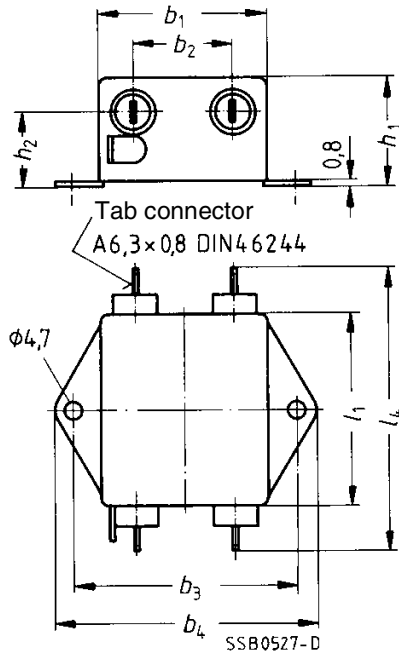

Case style A

B84112-B-A120

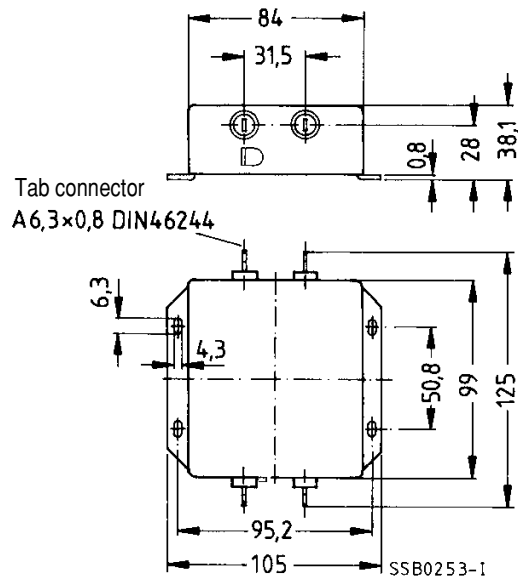

Case style B

B84112-B-B10 ...
B84112-B-B110

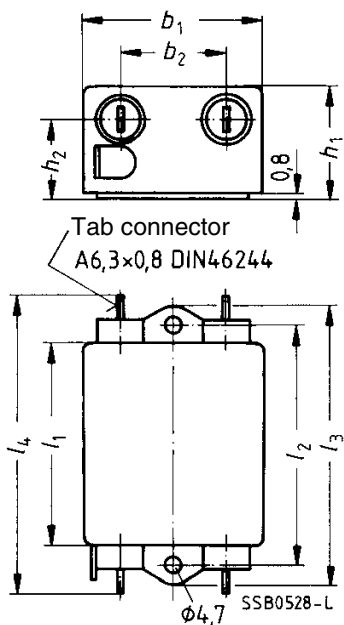

Case style B

B84112-B-B120

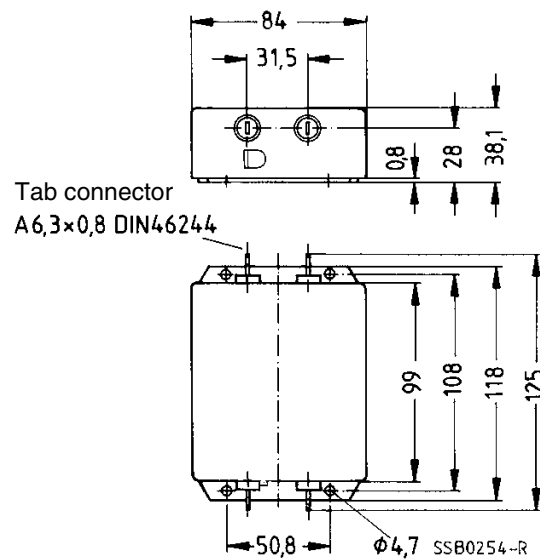

Case style K

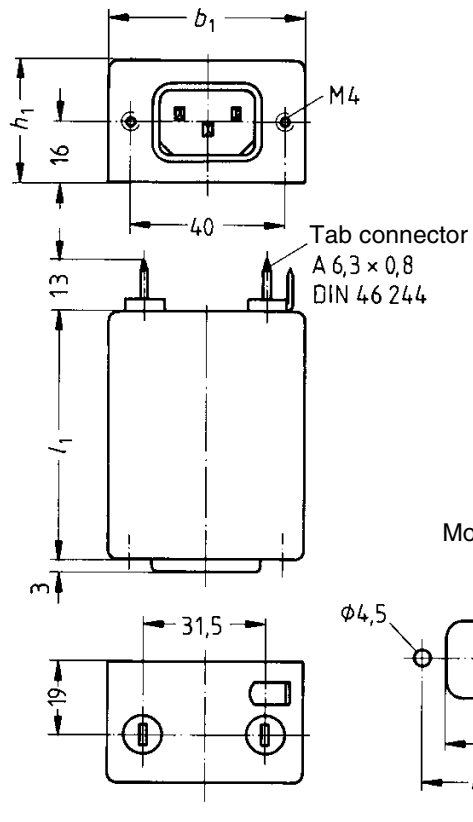

Case style L

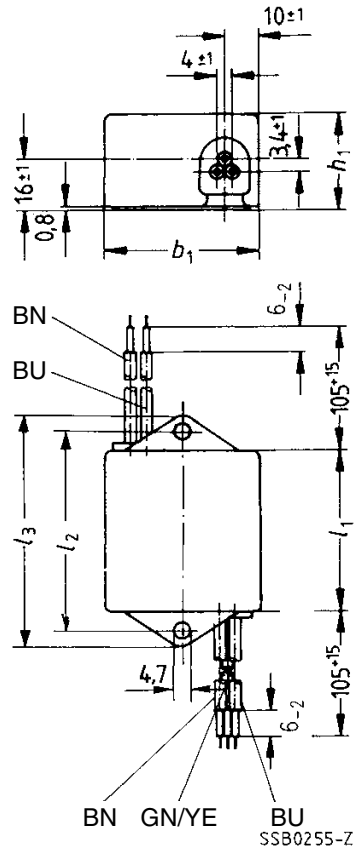

Case style P

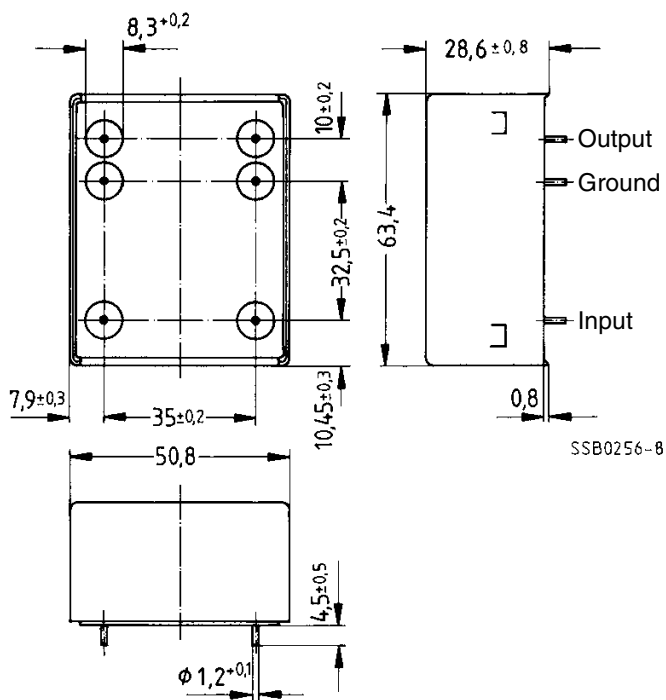

Insertion loss (typical values at $Z = 50 \Omega$)

- unsymmetrical, adjacent branches terminated
- - - - - common mode, all branches in parallel (asymmetrical)
- - - - - differential mode (symmetrical)

B84112-B-*10

B84112-B-*20

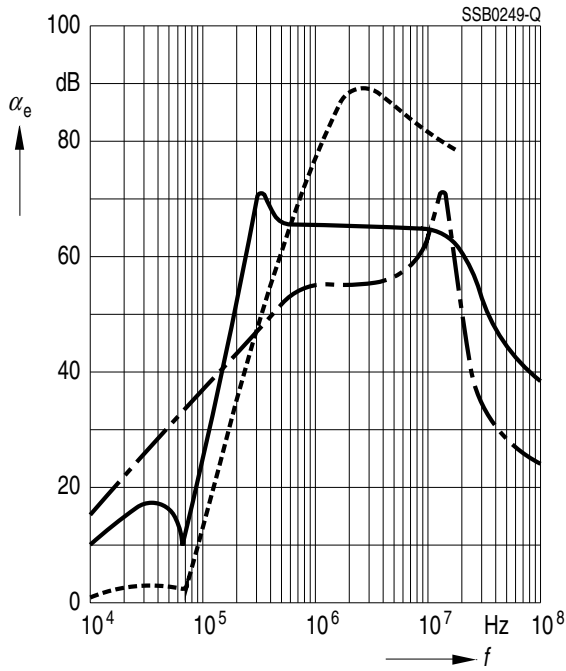

B84112-B-*30

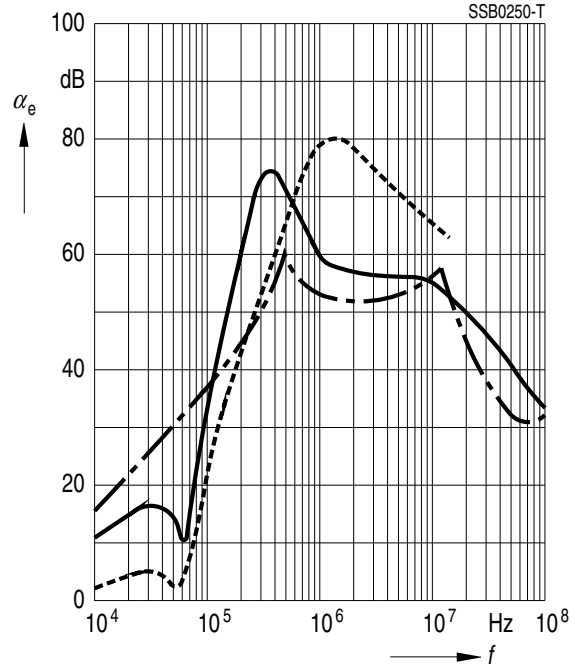

B84112-B-*60

B84112-B-*110

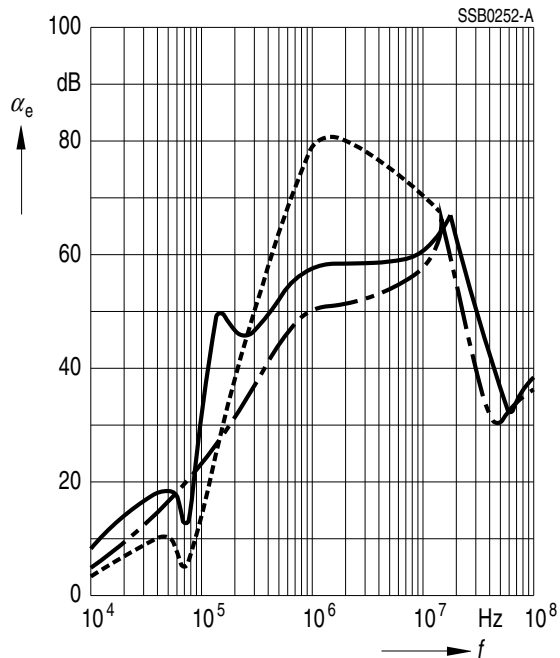

B84112-B-*120

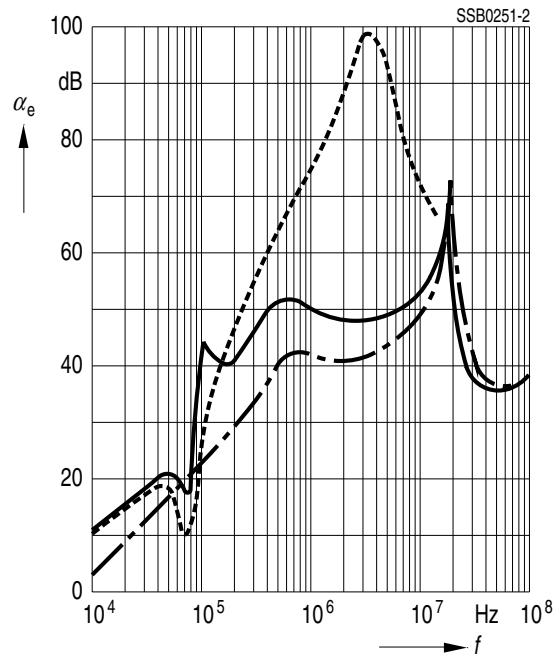

Herausgegeben von EPCOS AG

Marketing Kommunikation, Postfach 80 17 09, 81617 München, DEUTSCHLAND

© EPCOS AG 2000. Alle Rechte vorbehalten. Vervielfältigung, Veröffentlichung, Verbreitung und Verwertung dieser Broschüre und ihres Inhalts ohne ausdrückliche Genehmigung der EPCOS AG nicht gestattet.

Mit den Angaben in dieser Broschüre werden die Bauelemente spezifiziert, keine Eigenschaften zugesichert. Bestellungen unterliegen den vom ZVEI empfohlenen Allgemeinen Lieferbedingungen für Erzeugnisse und Leistungen der Elektroindustrie, soweit nichts anderes vereinbart wird.

Diese Broschüre ersetzt die vorige Ausgabe.

Fragen über Technik, Preise und Liefermöglichkeiten richten Sie bitte an den Ihnen nächstgelegenen Vertrieb der EPCOS AG oder an unsere Vertriebsgesellschaften im Ausland.

Bauelemente können aufgrund technischer Erfordernisse Gefahrstoffe enthalten. Auskünfte darüber bitten wir unter Angabe des betreffenden Typs ebenfalls über die zuständige Vertriebsgesellschaft einzuholen.

Published by EPCOS AG

Marketing Communications, P.O. Box 80 17 09, 81617 Munich, GERMANY

© EPCOS AG 2000. All Rights Reserved. Reproduction, publication and dissemination of this brochure and the information contained therein without EPCOS' prior express consent is prohibited.

The information contained in this brochure describes the type of component and shall not be considered as guaranteed characteristics. Purchase orders are subject to the General Conditions for the Supply of Products and Services of the Electrical and Electronics Industry recommended by the ZVEI (German Electrical and Electronic Manufacturers' Association), unless otherwise agreed.

This brochure replaces the previous edition.

For questions on technology, prices and delivery please contact the Sales Offices of EPCOS AG or the international Representatives.

Due to technical requirements components may contain dangerous substances. For information on the type in question please also contact one of our Sales Offices.