

1-phase filters FN 680

Two-stage performance EMI filter



- Rated currents from 1 to 10A
- Very high differential and common-mode attenuation
- Good low frequency attenuation

Approvals



Technical specifications

Maximum continuous operating voltage:	250VAC, 50/60Hz
Operating frequency:	dc to 400Hz
Rated currents:	1 to 10A @ 40°C max.
High potential test voltage:	P → E 2000VAC for 2 sec P → N 760VAC for 2 sec
Temperature range (operation and storage):	-25°C to +100°C (25/100/21)
Flammability corresponding to:	UL 94V-2 or better
Design corresponding to:	UL 1283, CSA 22.2 No. 8 1986, IEC/EN 60939
MTBF @ 40°C/230V (Mil-HB-217F):	1,400,000 hours

Typical electrical schematic

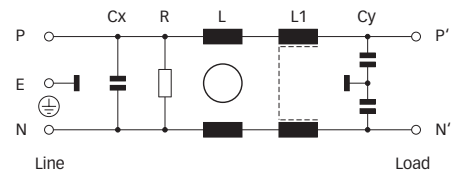

Features and benefits

- FN 680 filters are designed for easy and fast chassis mounting.
- FN 680 filters offer a perfect combination of performance/size ratio.
- FN 680 two-stage filters provide a very high differential and common-mode attenuation performance, based on chokes with high saturation resistance and excellent thermal behavior.
- FN 680 two-stage filters are designed for very high noise suppression and low frequency attenuation.
- Faston terminal connection with additional spade solder possibility or wire connection.
- Custom-specific versions on request.

Typical applications

- Electrical and electronic equipment
- Consumer goods
- Power supplies
- Building automation
- Elevators and cranes
- Office automation equipment
- Datacom equipment

Filter selection table

Filter*	Rated current @ 40°C (25°C) [A]	Leakage current** @ 230VAC/50Hz [µA]	Inductance		Capacitance		Resistance R [kΩ]	Input/Output connections		Weight	
			L [mH]	L1 [mH]	Cx [nF]	Cy [nF]		-06	-07	[g]	[g]
FN 680-1-..	1 (1.2)	410	22.5	1.2	220	4.7	1000	-06	-07	120	130
FN 680-2.5-..	2.5 (3)	410	16	0.27	220	4.7	1000	-06	-07	230	245
FN 682-4-..	4 (4.8)	1900	8	0.08	1000	22	330	-06	-07	250	255
FN 682-6.5-..	6.5 (7.8)	1900	4.1	0.055	470	22	470	-06	-07	590	600
FN 682-10-..	10 (12)	1900	4	0.04	470	22	470	-06	-07	950	970

* To compile a complete part number, please replace the .. with the required I/O connection style (e.g. FN 680-1-06, FN 682-10-07).

** Maximum leakage under normal operating conditions. Note: if the neutral line is interrupted, worst case leakage could reach twice this level.

Typical filter attenuation

Per CISPR 17; A = 50Ω/50Ω sym; B = 50Ω/50Ω asym; C = 0.1Ω/100Ω sym; D = 100Ω/0.1Ω sym

1A types

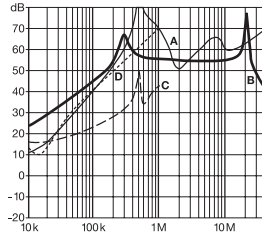

2.5A types

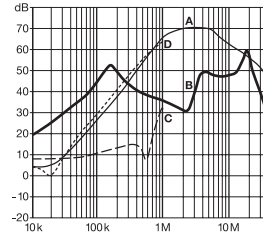

4A types

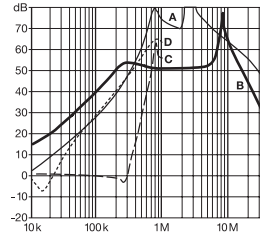

6.5 and 10A types

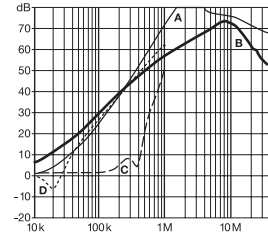

Mechanical data

Connection style -06, 1A types

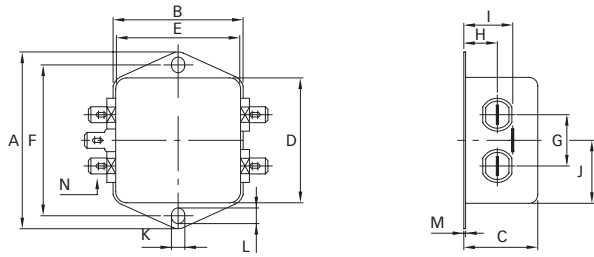

Connection style -07, 1A types (same dimensions as style -06)

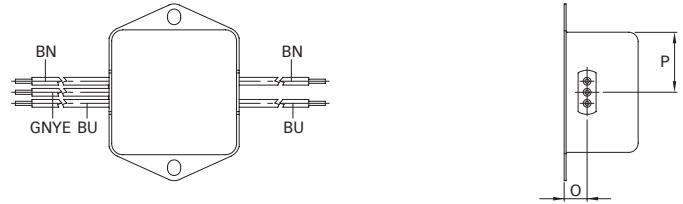

Connection style -06, 2.5 and 4A types

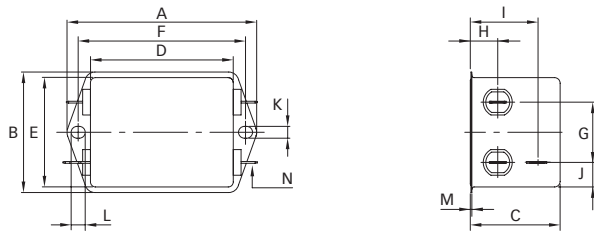

Connection style -07, 2.5 and 4A types

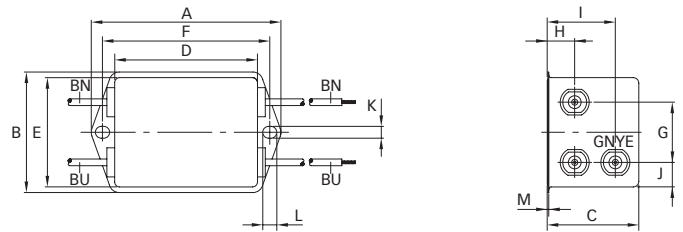

Connection style -06, 6.5 and 10A types

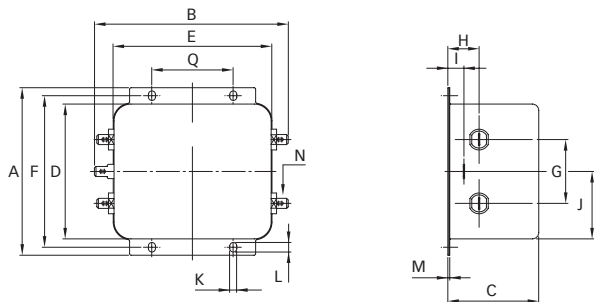

Connection style -07, 6.5 and 10A types

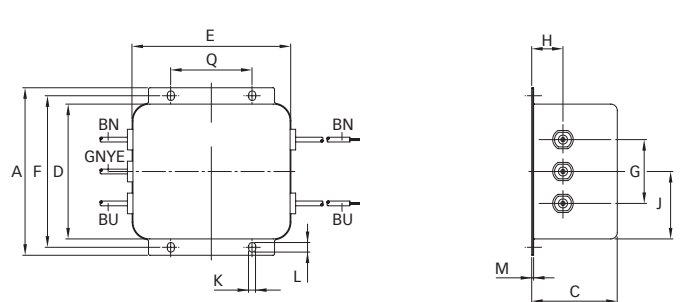

Dimensions

	1A	2.5A	4A	6.5A	10A	Tolerances
A	71.5	85	85	105	105	±0.5
B	52.6	54	54	126 ±1	126 ±1	±0.5
C	29.3 ±0.5	40.3	40.3	38	57.6	±1
D	50.5	64.8	64.8	84.5	84.5	±1
E	50.5	49.8	49.8	98.5	98.5	±1
F	61	75	75	95	95	±0.2
G	21	27	27	40	40	±0.5
H	14.3	12.6	12.6	9.5	9.5	±0.5
I	20.3	29.8	29.8	19	19	±0.5
J	25.25	11.4	11.4	42.25	42.25	±0.5
K	5.3	5.3	5.3	4.4	4.4	
L	6.3	6.3	6.3	6	6	
M	0.7	0.7	0.7			
N	6.3 x 0.8	6.3 x 0.8	6.3 x 0.8	6.3 x 0.8	6.3 x 0.8	

Connection style -07

O	8.3					±0.1
P	25.3					±0.5
AWG type wire	AWG 20	AWG 18	AWG 16	AWG 16	AWG 14	
Wire length	140	140	140	140	140	+5

All dimensions in mm; 1 inch = 25.4mm
Tolerances according: ISO 2768 / EN 22768

Your local partner: To find your local partner within Schaffner's global network, please go to www.schaffner.com