

3-phase filters FN 351

General purpose EMC filter for three-phase applications



- EMC solution for industrial inverters and motor drives
- Rated currents from 8 to 280A
- Selectable voltage level of 440V and 520V
- High differential and common-mode attenuation
- Compliant with IEC 60950

Approvals



Technical specifications

Maximum continuous operating voltage:	3x 440/250VAC (FN 351) 3x 520/300VAC (FN 351H)
Operating frequency:	dc to 60Hz
Rated currents:	8 to 280A @ 40°C
High potential test voltage:	P → E 2600VDC for 2 sec (FN 351) P → P 1900VDC for 2 sec (FN 351) P → E 2750VDC for 2 sec (FN 351H) P → P 2250VDC for 2 sec (FN 351H)
Protection category:	IP20
Overload capability:	4x rated current at switch on, 1.5x rated current for 1 minute, once per hour
Temperature range (operation and storage):	-25°C to +85°C (25/085/21) (FN 351) -25°C to +100°C (25/100/21) (FN 351H)
Flammability corresponding to:	UL 94V-2 or better
Design corresponding to:	UL 1283, CSA 22.2 No. 8 1986, IEC/EN 60939
MTBF @ 40°C/400V (Mil-HB-217F):	135,000 hours

Typical electrical schematic

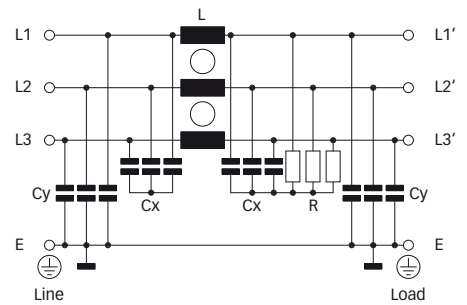

Features and benefits

- Broad range of power ratings for fast and convenient filter selection.
- Available as 440VAC (FN 351) and 520VAC (FN 351H) versions for network-specific applications.
- FN 351 filters provide a broadband common and differential-mode attenuation performance, which remains available also when high interference levels are present.
- Solid, touch-safe filter terminals contribute to overall equipment safety and make the filters compliant with IEC 60950.
- Introduced as one of the very first motor drive EMC filters in the market, FN 351 has been widely imitated and has successfully proven its function over more than 10 years.

Typical applications

- Three-phase motor drives
- Inverters and converters
- Industrial automation equipment
- UPS
- SMPS
- General purpose three-phase filtering

Filter selection table

Filter*	Rated current @ 40°C (25°C)	Typical drive power rating**	Leakage current*** @ 400VAC/50Hz	Power loss @ 25°C/50Hz	Input/Output connections	Weight [kg]
	[A]	[kW]	[mA]	[W]		
FN 351-8-29	8 (9.2)	3	1.9	7	-29	0.8
FN 351-16-29	16 (18.5)	5.5	1.9	8	-29	1.3
FN 351-25-33	25 (28.9)	11	28.0	8	-33	1.4
FN 351-36-33	36 (41.6)	15	28.0	9	-33	1.5
FN 351-50-..	50 (57.7)	22	29.5	11	-33 -34	1.6
FN 351-64-..	64 (73.9)	30	29.5	15	-33 -34	1.7
FN 351-80-34	80 (92.3)	37	31.8	23	-34	5.6
FN 351-110-35	110 (127)	55	31.8	25	-35	5.8
FN 351-180-36	180 (208)	90	29.6	49	-36	13.0
FN 351-280-37	280 (323)	132	35.7	70	-37	28.0
FN 351H-8-29	8 (9.2)	4	2.3	7	-29	1.1
FN 351H-16-29	16 (18.5)	7.5	2.3	8	-29	1.3
FN 351H-25-33	25 (28.9)	15	32.7	8	-33	1.4
FN 351H-36-33	36 (41.6)	18.5	32.7	9	-33	1.5
FN 351H-50-..	50 (57.7)	30	32.7	11	-33 -34	1.6
FN 351H-64-33	64 (73.9)	37	32.7	15	-33	1.7
FN 351H-80-34	80 (92.3)	45	38.0	23	-34	5.6
FN 351H-110-35	110 (127)	75	38.0	25	-35	5.8
FN 351H-180-36	180 (208)	110	35.6	49	-36	13.0
FN 351H-280-37	280 (323)	160	42.9	70	-37	28.0

* To compile a complete part number, please replace the .. with the required I/O connection style.

** Calculated at rated current, 400VAC (FN 351)/480VAC (FN 351H) and cos phi = 0.8. The exact value depends upon the efficiency of the drive, the motor and the entire application.

*** Maximum leakage under normal operating conditions (FN 351 at 400V, FN 351H at 480V). Note: if two phases are interrupted, worst case leakage could reach 6 times higher levels.

Typical filter attenuation

Per CISPR 17; A = 50Ω/50Ω sym; B = 50Ω/50Ω asym; C = 0.1Ω/100Ω sym; D = 100Ω/0.1Ω sym

8A types

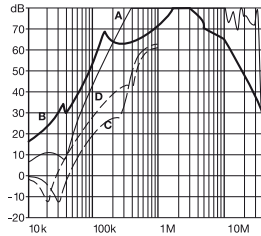

16A types

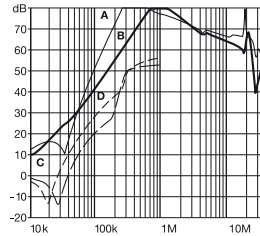

25A types

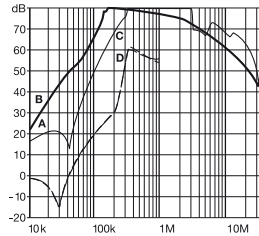

36 and 50A types

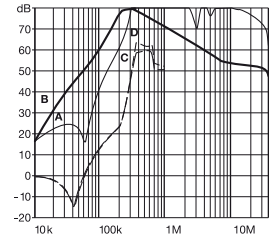

64A types

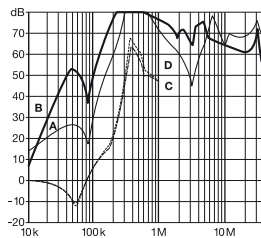

80 and 110A types

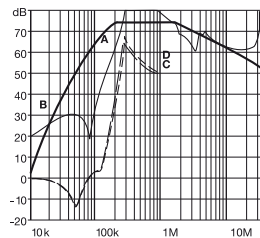

180A types

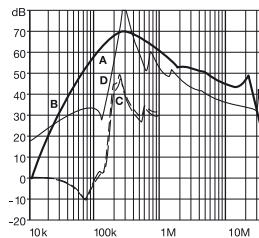

280A types

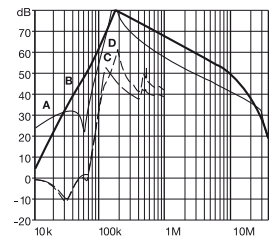

Mechanical data

8 and 16A types

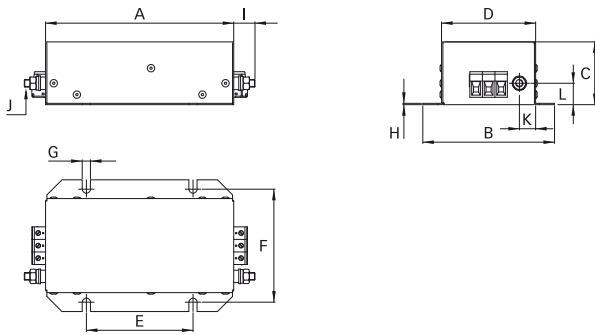

25 to 64A types

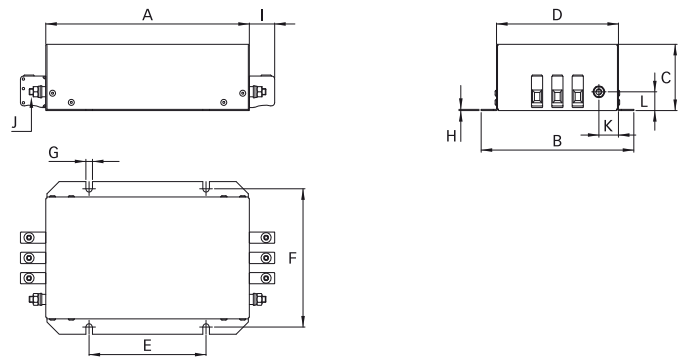

80 and 110A types

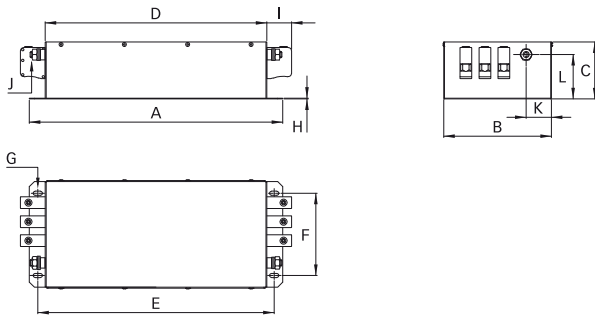

180 and 280A types

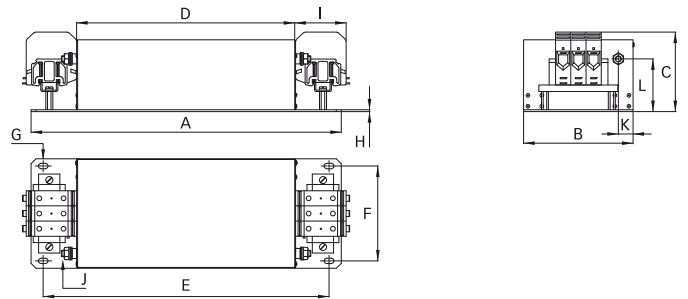

Dimensions

	8A	8A (-H)	16A	25A	36A	50A (-33)	50A (-34)	64A (-33)	64A (-34)	80A	110A	180A	280A
A	180	200	200	200	200	200	200	200	200	400	400	510	700
B	115	150	150	150	150	150	150	150	150	170	170	180	260
C	60	65	65	65	65	65	80	65	80	90	90	130	155
D	85	120	120	120	120	120	120	120	120	350	350	360	530
E	115	115	115	115	115	115	115	115	115	373	373	470	660
F	100	136	136	136	136	136	136	136	136	130	130	156	220
G	6.5	6.5	6.5	6.5	6.5	6.5	6.5	6.5	6.5	15 x 6.5	15 x 6.5	16 x 9	16 x 9
H	1	1	1	1	1	1	1	1	1	1	1	4	4
I	17	17	17	25	25	25	39	25	39	39	45	85	110
J	M6	M6	M6	M6	M6	M6	M6	M6	M6	M10	M10	M10	M10
K	13	19.25	19.25	19.25	19.25	19.25	18.75	19.25	18.75	40	40	25	30
L	17	17	17	18.4	18.4	18.4	17	18.4	17	70	70	85	100

All dimensions in mm; 1 inch = 25.4mm
Tolerances according: ISO 2768-m / EN 22768-m

Filter input/output connector cross sections

	-29	-33	-34	-35	-36	-37
Solid wire	6mm ²	16mm ²	35mm ²	50mm ²	95mm ²	150mm ²
Flex wire	4mm ²	10mm ²	25mm ²	50mm ²	95mm ²	150mm ²
AWG type wire	AWG 10	AWG 6	AWG 2	AWG 1/0	AWG 4/0	AWG 6/0
Recommended torque	0.6 - 0.8Nm	1.5 - 1.8Nm	4.0 - 4.5Nm	7 - 8Nm	17 - 20Nm	27 - 30Nm

Please visit www.schaffner.com to find more details on filter connectors.