

---

FN 2000 SERIES

*single-phase  
chassis-  
mounting filters*

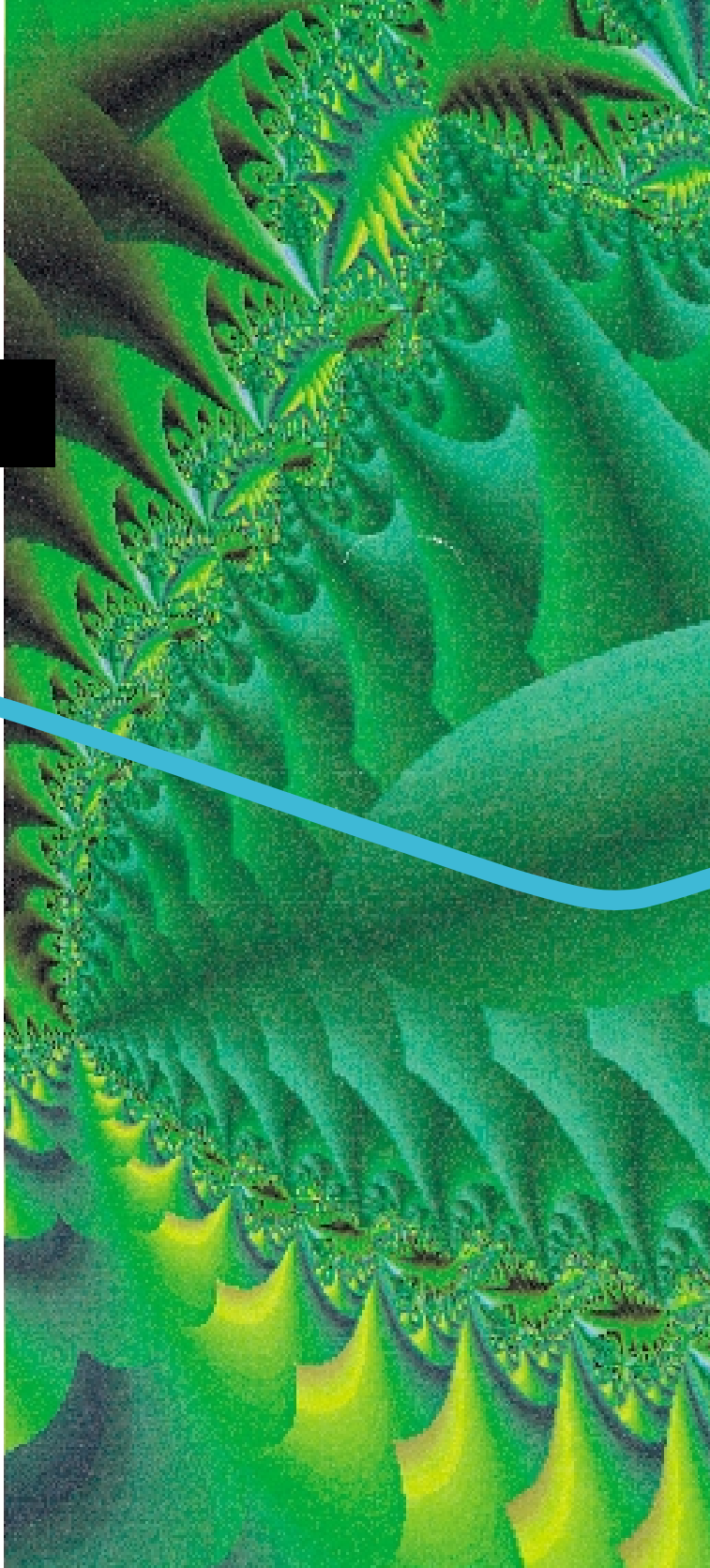

**SCHAFFNER**

Your number one name for EMC

# Schaffner's worldwide sales, distribution and production network

## HEADQUARTERS

*Schaffner EMV AG*  
Nordstrasse 11  
CH-4542 Luterbach  
**Switzerland**  
Tel: (032) 6816 626  
Fax: (032) 6816 641

## EUROLOGISTICS CENTER

*Schaffner*  
1A, avenue de Suisse  
F-68311 Illzach  
**France**  
Tel: (03) 89 31 04 00  
Fax: (03) 89 31 04 01

## FACTORIES

*Schaffner EMV AG*  
Nordstrasse 11  
CH-4542 Luterbach  
**Switzerland**  
Tel: (032) 6816 626  
Fax: (032) 6816 641

*Schaffner Ltd*  
National Technological Park  
Castletroy  
Limerick  
**Ireland**  
Tel: (061) 332233  
Fax: (061) 332584

*Schaffner EMC Co Ltd*  
67 Moo 4 Tambol Ban Klang  
Amphur Muang PO Box 14  
Lamphun 51000  
**Thailand**  
Tel: (053) 581 104  
Fax: (053) 581 019

## SALES SUBSIDIARIES

*Schaffner Beijing Liaison Office*  
Room 911, Bright China Chang An Building  
No. 7 Jianguomennei Dajie  
Beijing 100005  
**China**  
Tel: (10) 6510 1761  
Fax: (10) 6510 1763

*Schaffner SA*  
43 rue Michel Carré  
F-95103 Argenteuil  
**France**  
Tel: (01) 34 34 30 60  
Fax: (01) 39 47 02 28

*Rhone Alpes*  
F-38560 Champ sur Drac  
Tel: (04) 76 68 64 00  
Fax: (04) 76 68 63 70

*Rennes*  
F-35510 Cesson-Sévigné  
Tel: (02) 99 22 70 00  
Fax: (02) 99 22 70 07

*Schaffner EMV GmbH*  
Schoemperlenstrasse 12B  
D-76185 Karlsruhe  
**Germany**  
Tel: (0721) 56 910  
Fax: (0721) 56 9110

*Northern Germany*  
D-59581 Warstein  
Tel: (02902) 97 56 10  
Fax: (02902) 97 56 80

*Schaffner EMC Srl*  
Via Galileo Galilei, 47  
I-20092 Cinisello Balsamo (MI)  
**Italy**  
Tel: (02) 66 04 30 45  
Fax: (02) 61 23 943

*Schaffner EMC KK*  
2-31-6 Kamiuma  
Setagaya-Ku  
Tokyo 154-0011  
**Japan**  
Tel: (03) 3418 5822  
Fax: (03) 3418 3013

*Schaffner EMC Pte Ltd*  
1200 Depot Road 06-01  
Singapore 109675  
**Singapore**  
Tel: 377 3283  
Fax: 377 3281

*Schaffner EMC AB*  
Turebergstorg 1,6  
S-19186 Sollentuna  
**Sweden**  
Tel: (08) 921121  
Fax: (08) 929690

*Schaffner Altrac AG*  
Mühlehaldenstrasse 6  
CH-8953 Dietikon  
**Switzerland**  
Tel: (01) 744 61 11  
Fax: (01) 744 61 61

*Schaffner EMC Ltd*  
Ashville Way  
Molly Millar's Lane  
Wokingham  
Berks RG41 2PL  
**UK**  
Tel: (0118) 9770070  
Fax: (0118) 9792969

*Schaffner EMC Inc*  
9-B Fadem Road  
Springfield, NJ 07081  
**USA**  
Toll free: (800) 367 5566  
Tel: (973) 379 7778  
Fax: (973) 379 1151

*West Coast*  
Irvine, CA 92718  
Tel: (949) 457 9400  
Fax: (949) 457 9510

## DISTRIBUTORS

**Austria**  
*Eurodis Electronics GmbH* Tel: 1 610 620

**Belgium**  
*SEI Belgium* Tel: 456 0747

**Czech Republic**  
*Energo Praga Ltd.* Tel: 2 6111 2665

**Denmark**  
*Avnet Nortec A/S* Tel: 44 88 08 00

**Finland**  
*Electro Ferrum Oy* Tel: 19 326 616

**Netherlands**  
*SEI Benelux B.V.* Tel: 76 57 22 500

**Norway**  
*Avnet Nortec A/S* Tel: 66 77 36 00

**Poland**  
*Astat Sp.* Tel: 61 8488 871

**Spain**  
*Selco S.A.* Tel: 91 637 1011

**Sweden**  
*Avnet Nortec AB* Tel: 8 629 1400

**Turkey**  
*Artest Elektronik* Tel: 216 478 1757

**Australia**  
*Westek Industrial Products Pty Ltd.*  
Tel: 3 9369 8802

**Brasil**  
*Teknikao Ind e Com Ltda* Tel: 11 834 5544

**Hong Kong**  
*Denetron (HK) Ltd.* Tel: 2 707 9132

**India**  
*Vishal Agencies* Tel: 40 711 2079

**Israel**  
*RDT Components Ltd.* Tel: 3 645 0707

**Japan**  
*Nemic Lambda K.K.* Tel: 3 3447 4411  
*SSR Engineering Co. Ltd.* Tel: 3 3493 6613

*Unidux Inc* Tel: 422 32 4500

**Korea**  
*Power EMC TEK* Tel: 2 501 5852

**New Zealand**  
*MHS Technologies Ltd.* Tel: 4 567 7016

**Republic of South Africa**  
*Electronic Building Elements* Tel: 12 803 7680

**Taiwan**  
*Bandtek Int. Co. Ltd.* Tel: 2 2747 3733



## General-purpose filter

The FN 2010 family is designed to provide an economic solution for a wide variety of general-purpose filtering requirements. Available in 15 standard versions, with current ratings from 1 to 30A and a choice of three different connector styles, individual application requirements are easily and economically matched.

- current ratings from 1 to 30A
- general-purpose filtering performance
- three choices of connector style
- optional medical versions (B types)
- optional safety versions (A types)





See Mechanical Data on pages 12 - 13 for full details of housings and connections.

### Filter selection table

Choose the filter **FN xxxx-x** with the required current rating and features, and add **/??** to determine input/output (line/load) connection style. Example: FN 2010-10/06 is a 10A filter with fast-on connections.

### Approvals



| Filter         | Connections   |   |   | Current ratings<br>A at 40°C (25°) | Inductance<br>L<br>mH | Capacitance |          | Resistance<br>R<br>MΩ | Housing | Weight<br>g |
|----------------|---|---|---|------------------------------------|-----------------------|-------------|----------|-----------------------|---------|-------------|
|                |  |  |  |                                    |                       | Cx<br>μF    | Cy<br>nF |                       |         |             |
| FN 2010-1 /??  | /06   | /07   | -   | 1 (1.15)                           | 12                    | 0.1         | 4.7      | 1                     | F3      | 65          |
| FN 2010-3 /??  | /06   | /07   | -   | 3 (3.45)                           | 2.5                   | 0.1         | 4.7      | 1                     | F3      | 65          |
| FN 2010-6 /??  | /06   | /07   | -   | 6 (6.9)                            | 1                     | 0.1         | 4.7      | 1                     | F3      | 65          |
| FN 2010-10 /?? | /06   | /07   | -   | 10 (11.5)                          | 0.8                   | 0.1         | 4.7      | 1                     | F2      | 85          |
| FN 2010-12 /?? | /06   | /07   | -   | 12 (13.8)                          | 0.7                   | 0.1         | 4.7      | 1                     | F2      | 85          |
| FN 2010-16 /?? | /06   | /07   | -   | 16 (18.4)                          | 0.65                  | 0.1         | 4.7      | 1                     | H2      | 140         |
| FN 2010-20 /?? | /06   | -   | /08   | 20 (23)                            | 0.6                   | 0.1         | 4.7      | 1                     | K1      | 210         |
| FN 2010-30 /?? | -   | -   | /08   | 30 (34.5)                          | 0.67                  | 0.47        | 10       | 1                     | P       | 470         |

### Additional specifications and options

| Filter type                        | Maximum operating voltage |       | Operating frequency<br>Hz | Hipot test voltage |            | MTBF<br>Per Mil-HB-217F at 40°C 230V<br>hours | Maximum leakage<br>mA/phase |
|------------------------------------|---------------------------|-------|---------------------------|--------------------|------------|---|-----------------------------|
|                                    | VAC                       | Hz    |                           | PN→E<br>VAC        | P→N<br>VDC |   |                             |
| Standard types                     | 250                       | 50/60 | DC to 400                 | 2000               | 1700       | 800 000                                       | 0.4*                        |
| B medical types (no Y capacitors)  | 250                       | 50/60 | DC to 400                 | 2500               | 1700       | 800 000                                       | 0.002                       |
| A safety types (lower capacitance) | 250                       | 50/60 | DC to 400                 | 2500               | 1700       | 800 000                                       | 0.040                       |

\* 1mA for 30A version

## Insertion loss

Per CISPR 17; A = 50Ω/50Ω sym, B = 50Ω/50Ω asym, C = 0.1Ω/100Ω sym, D = 100Ω/0.1Ω sym

### 1A types

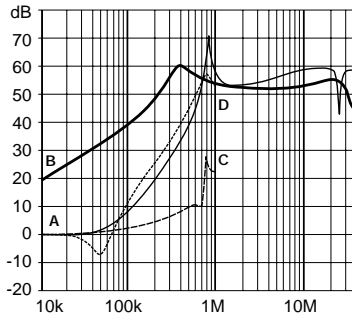

### 3A types

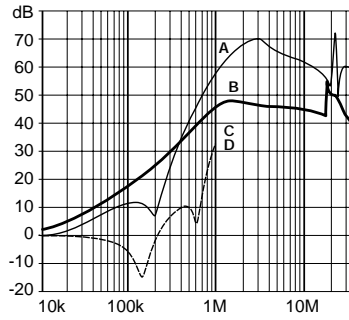

### 6A types

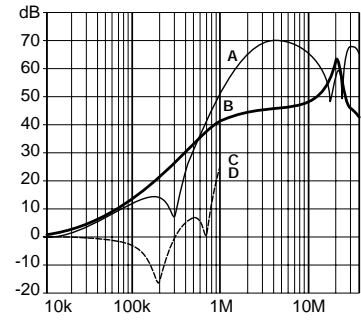

### 10A types (12A\*)

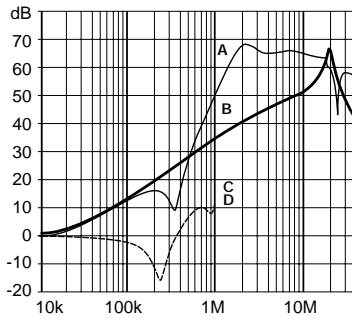

### 16A types

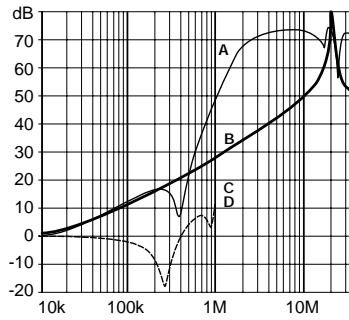

### 20A types

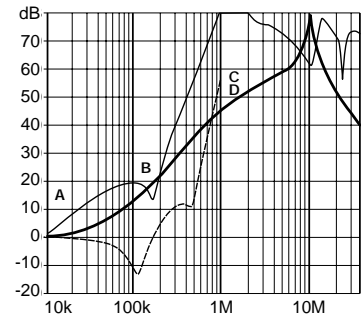

### 30A types

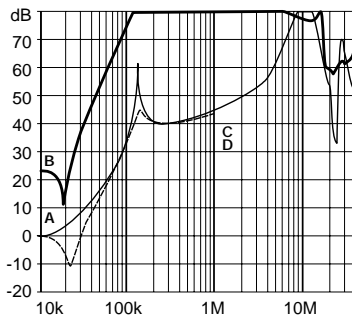

\* attenuation performance of the 12A version is similar to the 10A component.

## Electrical schematics

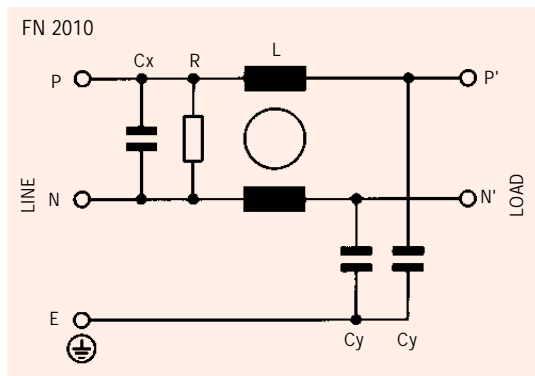

See tables for component values.

## General-purpose filter

## FN 2020

Similar to FN 2010, but with additional phase-to-neutral capacitance for improved differential mode performance, the FN 2020 family is designed to provide an economic solution for many general-purpose filtering requirements. Available in 15 standard versions, with current ratings from 1 to 30A, individual application requirements are easily and economically matched.

- current ratings from 1 to 30A
- high differential mode attenuation
- three choices of connector style
- optional medical versions (B types)
- optional safety versions (A types)





See Mechanical Data on pages 12 -13 for full details of housings and connections.

### Filter selection table

Choose the filter **FN xxxx-x** with the required current rating and features, and add **/??** to determine input/output (line/load) connection style. Example: FN 2020-10/06 is a 10A filter with fast-on connections.

### Approvals



| Filter         | Connections   |   |   | Current ratings<br>A at 40°C (25°) | Inductance<br>L<br>mH | Capacitance |          | Resistance<br>R<br>MΩ | Housing | Weight<br>g |
|----------------|---|---|---|------------------------------------|-----------------------|-------------|----------|-----------------------|---------|-------------|
|                |  |  |  |                                    |                       | Cx<br>μF    | Cy<br>nF |                       |         |             |
| FN 2020-1 /??  | /06   | /07   | -   | 1 (1.15)                           | 12                    | 0.15        | 4.7      | 1                     | F2      | 80          |
| FN 2020-3 /??  | /06   | /07   | -   | 3 (3.45)                           | 2.5                   | 0.15        | 4.7      | 1                     | F2      | 80          |
| FN 2020-6 /??  | /06   | /07   | -   | 6 (6.9)                            | 1                     | 0.15        | 4.7      | 1                     | F2      | 80          |
| FN 2020-10 /?? | /06   | /07   | -   | 10 (11.5)                          | 0.8                   | 0.15        | 4.7      | 1                     | F2      | 85          |
| FN 2020-12 /?? | /06   | /07   | -   | 12 (13.8)                          | 0.7                   | 0.15        | 4.7      | 1                     | F2      | 85          |
| FN 2020-16 /?? | /06   | /07   | -   | 16 (18.4)                          | 0.65                  | 0.15        | 4.7      | 1                     | H2      | 140         |
| FN 2020-20 /?? | /06   | -   | /08   | 20 (23)                            | 0.6                   | 0.15        | 4.7      | 1                     | K1      | 210         |
| FN 2020-30 /?? | -   | -   | /08   | 30 (34.5)                          | 0.67                  | 0.47        | 10       | 0.47                  | P       | 470         |

### Additional specifications and options

| Filter type                        | Maximum operating voltage |       | Operating frequency<br>Hz | Hipot test voltage |            | MTBF<br>Per Mil-HB-217F at 40°C 230V<br>hours | Maximum leakage<br>mA/phase |
|------------------------------------|---------------------------|-------|---------------------------|--------------------|------------|---|-----------------------------|
|                                    | VAC                       | Hz    |                           | PN→E<br>VAC        | P→N<br>VDC |   |                             |
| Standard types                     | 250                       | 50/60 | DC to 400                 | 2000               | 1700       | 600 000                                       | 0.4*                        |
| B medical types (no Y capacitors)  | 250                       | 50/60 | DC to 400                 | 2500               | 1700       | 600 000                                       | 0.002                       |
| A safety types (lower capacitance) | 250                       | 50/60 | DC to 400                 | 2500               | 1700       | 600 000                                       | 0.040                       |

\* 1mA for 30A version

## Insertion loss

Per CISPR 17; A = 50Ω/50Ω sym, B = 50Ω/50Ω asym, C = 0.1Ω/100Ω sym, D = 100Ω/0.1Ω sym

### 1A types

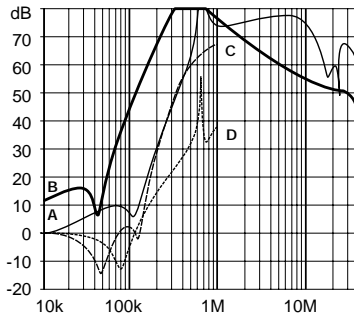

### 3A types

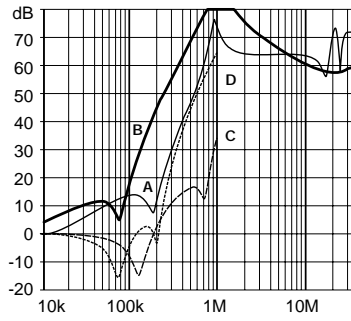

### 6A types

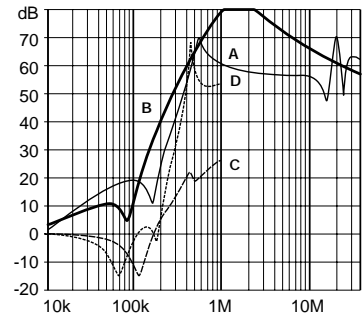

### 10A types (12A\*)

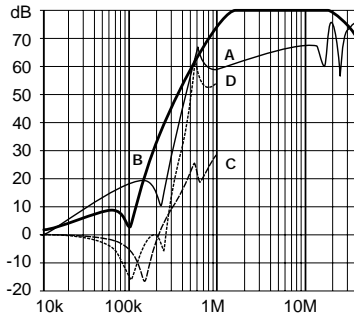

### 16A types

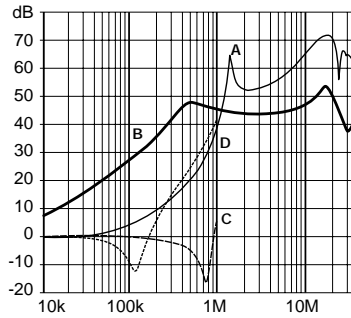

### 20A types

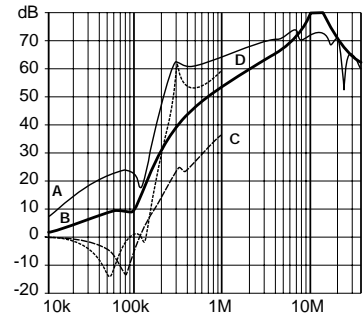

### 30A types

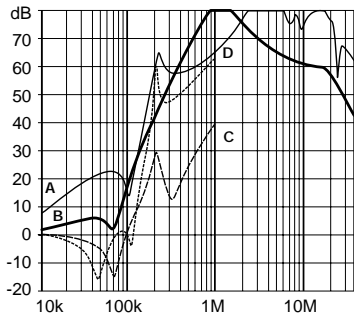

\*attenuation performance of the 12A version is similar to the 10A component.

## Electrical schematics

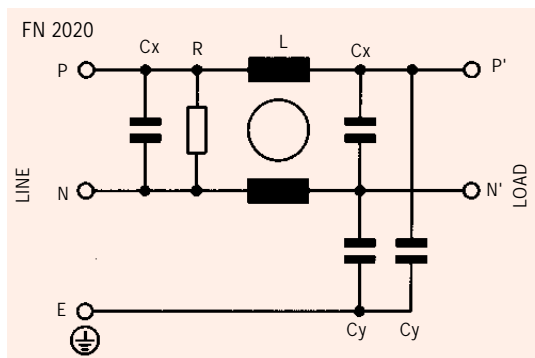

See tables for component values.

## Multi-stage general-purpose filter FN 2060

Similar to FN 2020, but with additional inductance stages for higher common mode attenuation, the FN 2060 family is designed to provide an economic solution for many general-purpose filtering requirements. Available in 16 standard versions, with current ratings from 1 to 30A, individual application requirements are easily and economically matched.

- current ratings from 1 to 30A
- high differential and common mode attenuation
- three choices of connector
- optional medical versions (B types)
- optional safety versions (A types)





See Mechanical Data on pages 12 - 13 for full details of housings and connections.

### Filter selection table

Choose the filter **FN xxxx-x** with the required current rating and features, and add **/??** to determine input/output (line/load) connection style. Example: FN 2060-10/08 is a 10A filter with screw feed-through connections.

### Approvals



| Filter         | Connections   |   |   | Current ratings<br>A at 40°C (25°) | Inductance<br>L<br>mH | Capacitance |          | Resistance<br>R<br>MΩ | Housing | Weight<br>g |
|----------------|---|---|---|------------------------------------|-----------------------|-------------|----------|-----------------------|---------|-------------|
|                |  |  |  |                                    |                       | Cx<br>μF    | Cy<br>nF |                       |         |             |
| FN 2060-1 /??  | /06   | /07   | -   | 1 (1.15)                           | 12                    | 0.22        | 4.7      | 1                     | H2      | 120         |
| FN 2060-3 /??  | /06   | /07   | -   | 3 (3.45)                           | 2.5                   | 0.22        | 4.7      | 1                     | H2      | 120         |
| FN 2060-6 /??  | /06   | /07   | -   | 6 (6.9)                            | 0.97                  | 0.22        | 4.7      | 1                     | H2      | 120         |
| FN 2060-10 /?? | /06   | /07   | -   | 10 (11.5)                          | 0.8                   | 0.47        | 4.7      | 0.47                  | K1      | 190         |
| FN 2060-12 /?? | /06   | /07   | -   | 12 (13.8)                          | 0.58                  | 0.47        | 4.7      | 0.47                  | K1      | 190         |
| FN 2060-16 /?? | /06   | /07   | /08   | 16 (18.4)                          | 0.65                  | 0.33        | 4.7      | 1                     | K2      | 260         |
| FN 2060-20 /?? | /06   | -   | /08   | 20 (23)                            | 0.6                   | 1           | 4.7      | 0.22                  | P       | 480         |
| FN 2060-30 /?? | -   | -   | /08   | 30 (34.5)                          | 0.6                   | 1           | 10       | 0.22                  | L2      | 950         |

### Additional specifications and options

| Filter type                        | Maximum operating voltage |       | Operating frequency<br>Hz | Hipot test voltage |            | MTBF<br>Per Mil-HB-217F at 40°C 230V<br>hours | Maximum leakage<br>mA/phase |
|------------------------------------|---------------------------|-------|---------------------------|--------------------|------------|---|-----------------------------|
|                                    | VAC                       | Hz    |                           | PN→E<br>VAC        | P→N<br>VDC |   |                             |
| Standard types                     | 250                       | 50/60 | DC to 400                 | 2000               | 1700       | 450 000                                       | 0.4*                        |
| B medical types (no Y capacitors)  | 250                       | 50/60 | DC to 400                 | 2500               | 1700       | 450 000                                       | 0.002                       |
| A safety types (lower capacitance) | 250                       | 50/60 | DC to 400                 | 2500               | 1700       | 450 000                                       | 0.040                       |

\* 1mA for 30A version



## Insertion loss

Per CISPR 17; A = 50Ω/50Ω sym, B = 50Ω/50Ω asym, C = 0.1Ω/100Ω sym, D = 100Ω/0.1Ω sym

### 1A types

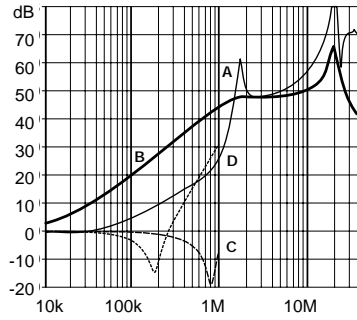

### 3A types

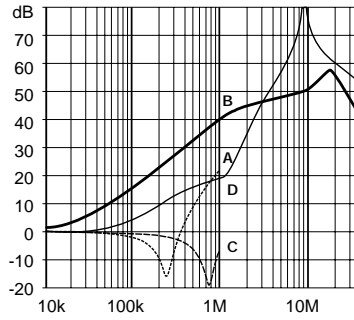

### 6A types

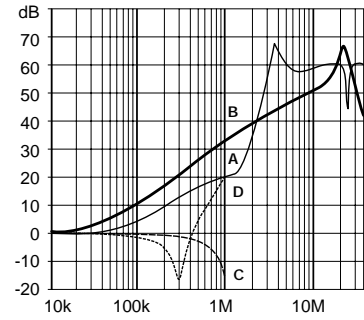

### 10A types (12A\*)

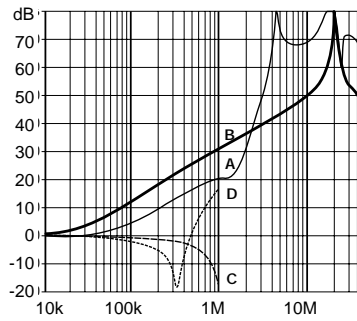

### 16A types

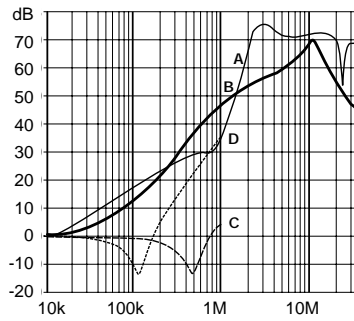

### 20A types

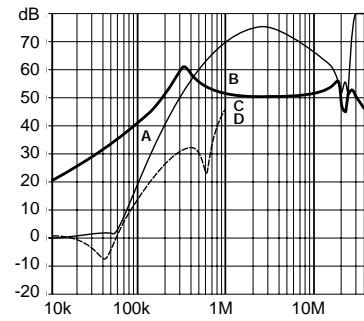

### 30A types

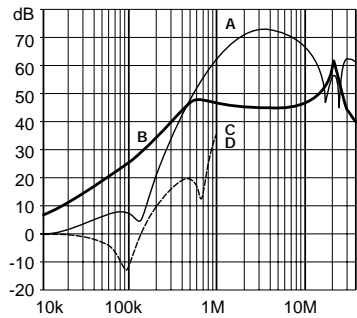

\* attenuation performance of the 12A version is similar to the 10A component.

## Electrical schematics

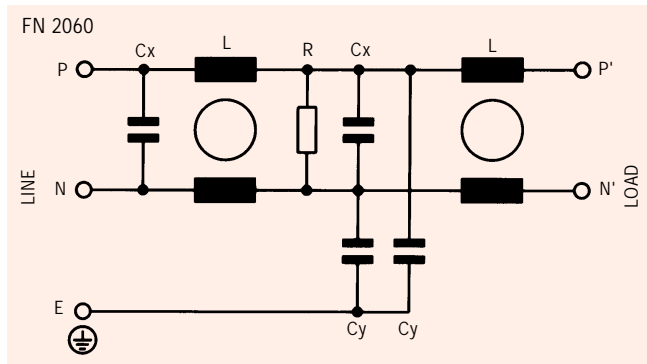

See tables for component values.

### Multi-stage performance filter

Similar to FN 2060, but with even higher inductance and capacitance values for excellent differential and common mode attenuation - especially at high frequencies - the FN 2070 family is designed to provide a cost-effective solution for broadband filtering requirements. Available in 13 standard versions, with current ratings from 1 to 16A, the filters are ideal for use with precision instrumentation, switched-mode power supplies and motor drives.

- current ratings from 1 to 16A
- very high differential and common mode attenuation
- good high-frequency attenuation
- three choices of connector
- optional medical versions (B types)
- optional safety versions (A types)





See Mechanical Data on pages 12 - 13 for full details of housings and connections.

#### Filter selection table

Choose the filter **FN xxxx-x** with the required current rating and features, and add **/??** to determine input/output (line/load) connection style. Example: FN 2070-10/06 is a 10A filter with fast-on connections.

#### Approvals



| Filter         | Connections   |   |   | Current ratings<br>A at 40°C (25°) | Inductance<br>L<br>mH | Capacitance |          | Resistance<br>R<br>MΩ | Housing | Weight<br>g |
|----------------|---|---|---|------------------------------------|-----------------------|-------------|----------|-----------------------|---------|-------------|
|                |  |  |  |                                    |                       | Cx<br>μF    | Cy<br>nF |                       |         |             |
| FN 2070-1 /??  | /06   | /07   | -   | 1 (1.15)                           | 22                    | 0.33        | 4.7      | 1                     | K1      | 190         |
| FN 2070-3 /??  | /06   | /07   | -   | 3 (3.45)                           | 9.8                   | 0.47        | 4.7      | 0.47                  | K2      | 250         |
| FN 2070-6 /??  | /06   | /07   | -   | 6 (6.9)                            | 7.8                   | 1           | 4.7      | 0.22                  | P       | 450         |
| FN 2070-10 /?? | /06   | /07   | -   | 10 (11.5)                          | 4.5                   | 1           | 4.7      | 0.22                  | Q       | 730         |
| FN 2070-12 /?? | /06   | /07   | -   | 12 (13.8)                          | 3.25                  | 1           | 4.7      | 0.22                  | Q       | 730         |
| FN 2070-16 /?? | /06   | /07   | /08   | 16 (18.4)                          | 2.8                   | 1           | 4.7      | 0.22                  | L2      | 1000        |

#### Additional specifications and options

| Filter type                        | Maximum operating voltage |       | Operating frequency<br>Hz | Hipot test voltage |            | MTBF<br>Per Mil-HB-217F at 40°C 230V<br>hours | Maximum leakage<br>mA/phase |
|------------------------------------|---------------------------|-------|---------------------------|--------------------|------------|---|-----------------------------|
|                                    | VAC                       | Hz    |                           | PN→E<br>VAC        | P→N<br>VDC |   |                             |
| Standard types                     | 250                       | 50/60 | DC to 400                 | 2000               | 1700       | 400 000                                       | 0.4                         |
| B medical types (no Y capacitors)  | 250                       | 50/60 | DC to 400                 | 2500               | 1700       | 400 000                                       | 0.002                       |
| A safety types (lower capacitance) | 250                       | 50/60 | DC to 400                 | 2500               | 1700       | 400 000                                       | 0.040                       |

## Insertion loss

Per CISPR 17; A = 50Ω/50Ω sym, B = 50Ω/50Ω asym, C = 0.1Ω/100Ω sym, D = 100Ω/0.1Ω sym

### 1A types

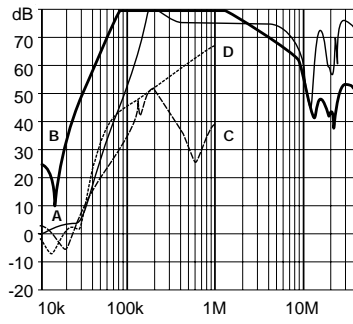

### 3A types

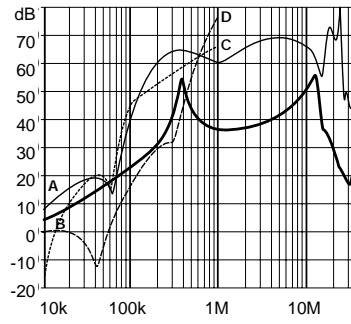

### 6A types

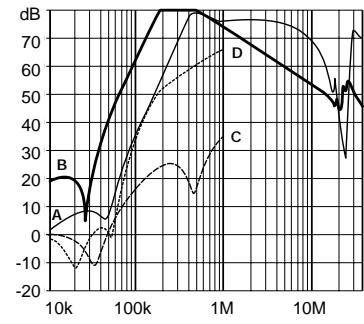

### 10A types (12A\*)

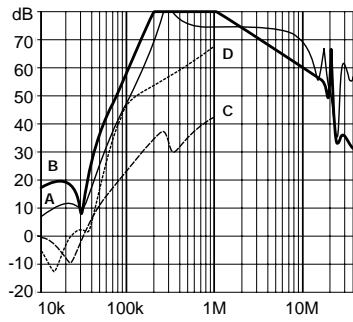

### 16A types

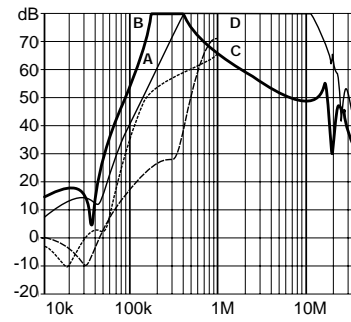

\* attenuation performance of the 12A version is similar to the 10A component.

## Electrical schematics

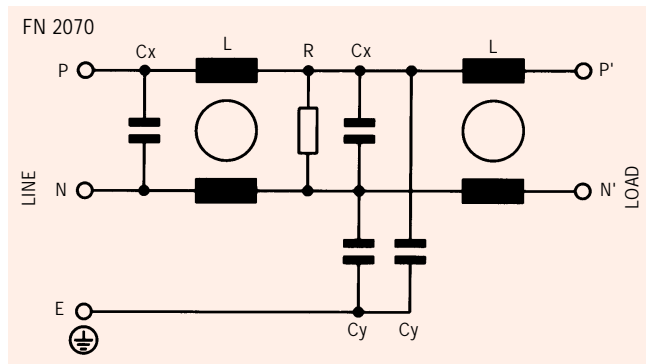

See tables for component values.

## Multi-stage high-performance filter FN 2080

Similar to FN 2070, but employing independent differential mode chokes rather than common mode chokes in the second stage, the FN 2080 family of filters provides excellent broadband attenuation, including low frequencies. Available in 13 standard versions, with current ratings from 1 to 16A, the filters are ideal for protecting against very high levels of interference, such as in noisy power supplies.

- current ratings from 1 to 16A
- very high differential and common mode attenuation
- good low-frequency attenuation
- three choices of connector
- optional medical versions (B types)
- optional safety versions (A types)



See Mechanical Data on pages 12 -13 for full details of housings and connections.

### Filter selection table

Choose the filter **FN xxxx-x** with the required current rating and features, and add **/??** to determine input/output (line/load) connection style. Example: FN 2080-10/06 is a 10A filter with fast-on connections.

### Approvals



| Filter         | Connections |     |     | Current ratings |        | Inductance |          | Capacitance |          | Resistance | Housing | Weight<br>g |
|----------------|-------------|-----|-----|-----------------|--------|------------|----------|-------------|----------|------------|---------|-------------|
|                |             |     |     | A at 40°C (25°) |        | L<br>mH    | L1<br>mH | Cx<br>μF    | Cy<br>nF | R<br>MΩ    |         |             |
| FN 2080-1 /??  | /06         | /07 | -   | 1               | (1.15) | 22         | 0.49     | 0.33        | 4.7      | 1          | K1      | 200         |
| FN 2080-3 /??  | /06         | /07 | -   | 3               | (3.45) | 9.8        | 0.16     | 0.47        | 4.7      | 0.47       | K2      | 270         |
| FN 2080-6 /??  | /06         | /07 | -   | 6               | (6.9)  | 7.8        | 0.11     | 1           | 4.7      | 0.22       | P       | 470         |
| FN 2080-10 /?? | /06         | /07 | -   | 10              | (11.5) | 4.5        | 0.06     | 1           | 4.7      | 0.22       | Q       | 750         |
| FN 2080-12 /?? | /06         | /07 | -   | 12              | (13.8) | 3.25       | 0.05     | 1           | 4.7      | 0.22       | Q       | 750         |
| FN 2080-16 /?? | /06         | /07 | /08 | 16              | (18.4) | 2.8        | 0.043    | 1           | 4.7      | 0.22       | L2      | 1020        |

### Additional specifications and options

| Filter type                        | Maximum operating voltage |       | Operating frequency<br>Hz | Hipot test voltage |            | MTBF<br>Per Mil-HB-217F at 40°C 230V<br>hours | Maximum leakage<br>mA/phase |
|------------------------------------|---------------------------|-------|---------------------------|--------------------|------------|---|-----------------------------|
|                                    | VAC                       | Hz    |                           | PN→E<br>VAC        | P→N<br>VDC |   |                             |
| Standard types                     | 250                       | 50/60 | DC to 400                 | 2000               | 1700       | 350 000                                       | 0.4                         |
| B medical types (no Y capacitors)  | 250                       | 50/60 | DC to 400                 | 2500               | 1700       | 350 000                                       | 0.002                       |
| A safety types (lower capacitance) | 250                       | 50/60 | DC to 400                 | 2500               | 1700       | 350 000                                       | 0.040                       |

## Insertion loss

Per CISPR 17; A = 50Ω/50Ω sym, B = 50Ω/50Ω asym, C = 0.1Ω/100Ω sym, D = 100Ω/0.1Ω sym

### 1A types

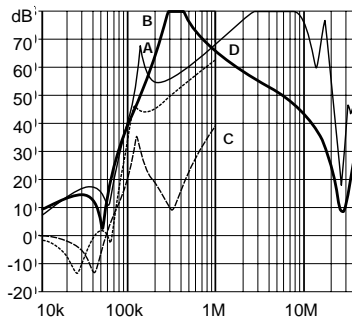

### 3A types

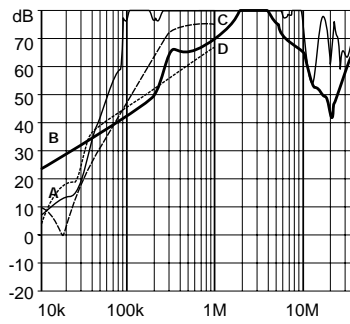

### 6A types

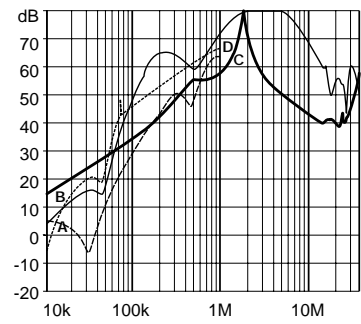

### 10A types (12A\*)

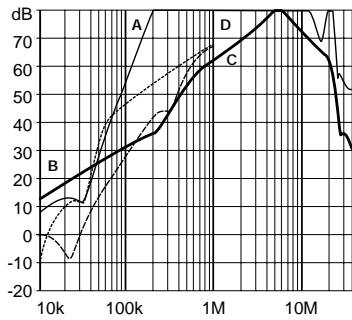

### 16A types

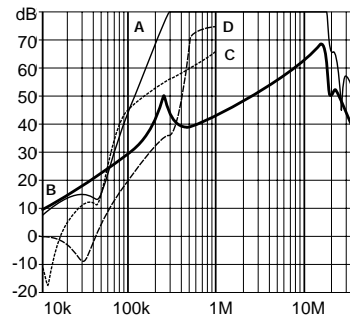

\* attenuation performance of the 12A version is similar to the 10A component.

## Electrical schematics

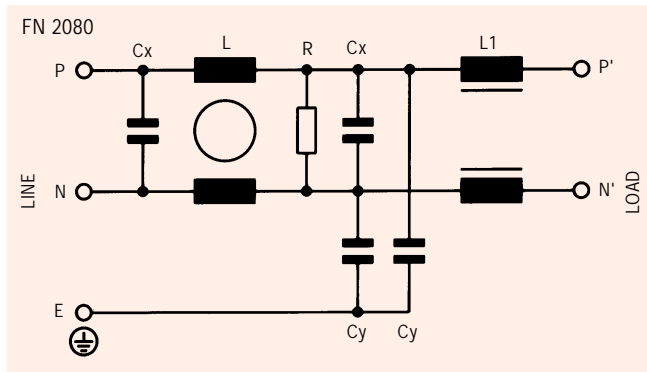

See tables for component values.

| Housing style | F2                    | F3   | H2                     | K1  | K2                     | Tol.*<br>± mm |
|---------------|-----------------------|------|------------------------|---|------------------------|---------------|
| <b>A</b>      | 64 ± 0.3              |      | 71                     | 85  |                        | ± 0.5         |
| <b>B</b>      | 35                    |      | 46.6                   | 54  |                        | ± 0.5         |
| <b>C</b>      | 29.3                  | 24.3 | 29.3                   | 30.3                                      | 40.3                   | ± 0.5         |
| <b>D</b>      | 43.5                  |      | 50.5                   | 64.8                                      |                        | ± 0.5         |
| <b>F</b>      | 54                    |      | 61                     | 75  |                        | ± 0.3         |
| <b>J</b>      | 21                    |      | 21                     | 27  |                        | ± 0.2         |
| <b>K</b>      | 8.3 <sup>§</sup> /9.3 |      | 10.8/8.3 <sup>§</sup>  | 12.3/8.3 <sup>§</sup>                     |                        | ± 0.5         |
| <b>L</b>      | 15.3                  |      | 19.3                   | 20.8/23.3                                 | 29.8                   | ± 0.5         |
| <b>M</b>      | 5.3                   |      | 5.3                    |   |                        | ± 0.1         |
| <b>N</b>      | 6.3                   |      | 6.3                    |   |                        | ± 0.1         |
| <b>P</b>      | 0.7                   |      | 0.7                    |   |                        | ± 0.1         |
| <b>S</b>      |                       |      | 20.1/30.5 <sup>§</sup> | 19.9/34.9 <sup>§</sup> /21.4 <sup>†</sup> | 11.4/34.9 <sup>§</sup> | ± 0.5         |

All dimensions in mm; 1 inch = 25.4mm.

§ with /07 connections

† with /08 connections

\* Measurements share this common tolerance unless otherwise stated.

## SIDE

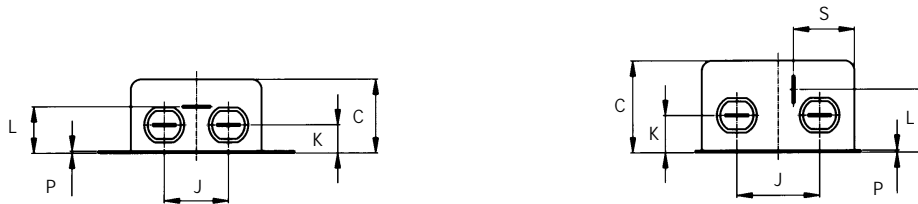

## TOP

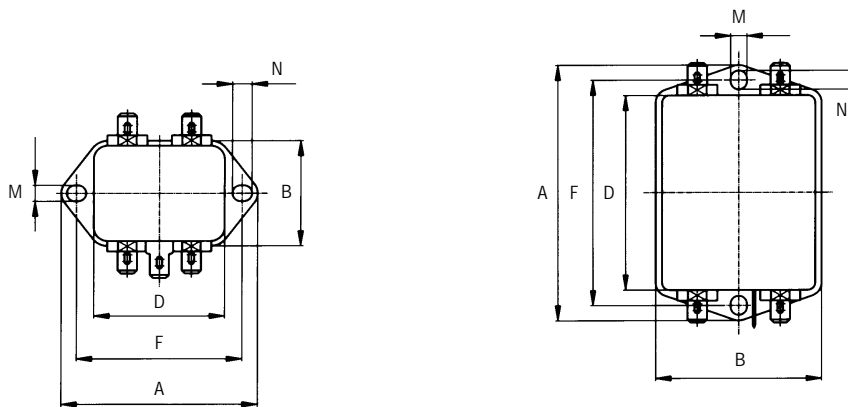

Housings F2 and F3

Housings H2, K1 and K2

# Mechanical Data

# I/O connections

| Housing style | P                     | Q     | L2                    | Tol.*<br>± mm |
|---------------|-----------------------|-------|-----------------------|---------------|
| A             | 113.5                 | 156   | 119 ± 0.5             | ± 1           |
| B             | 57.5                  |       | 85.5                  | ± 1           |
| C             | 45.4 ± 1.2            |       | 57.6                  | ± 1           |
| D             | 94                    | 130.5 | 98.5                  | ± 1           |
| F             | 103                   | 143   | 109                   | ± 0.3         |
| J             | 25                    |       | 40                    | ± 0.2         |
| K             | 12.4/8.4 <sup>§</sup> |       | 15.6/8.6 <sup>§</sup> | ± 0.5         |
| L             | 32.4                  |       |                       | ± 0.5         |
| M             | 4.4                   | 5.3   | 4.4                   | ± 0.1         |
| N             | 6                     |       | 7.4                   | ± 0.1         |
| P             | 0.9                   |       | 1.2                   | ± 0.1         |
| Q             |                       |       | 66                    | ± 0.3         |
| R             |                       |       | 51                    | ± 0.2         |
| S             | 15.5/38 <sup>§</sup>  |       |                       | ± 0.5         |

All dimensions in mm; 1 inch = 25.4mm.

§ with /07 connections

\* Measurements share this common tolerance unless otherwise stated.

These are the standard types of input and output connections available for Schaffner's range of filter families.

Schaffner can also produce filters with other popular output connectors, or user-specific interfaces, to custom order. Please call your local sales office to discuss requirements.

Dimensions in mm. 1 inch = 25.4mm

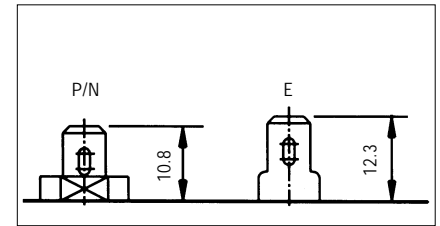

### Type /06

Industry-standard size fast-on which may also be used as a solder lug, 6.3 x 0.8mm.

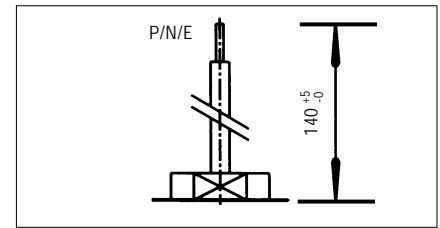

### Type /07

Insulated wire, stripped ready for soldering. Wire gauge varies according to filter.

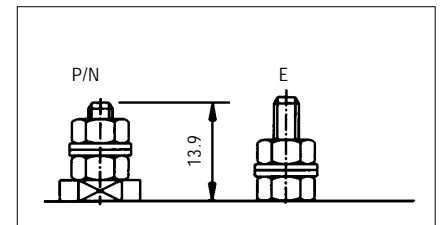

### Type /08

M4 screw

## SIDE

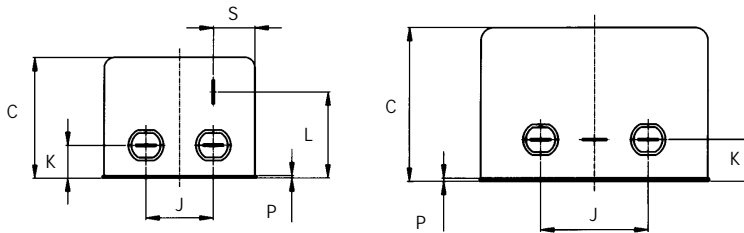

## TOP

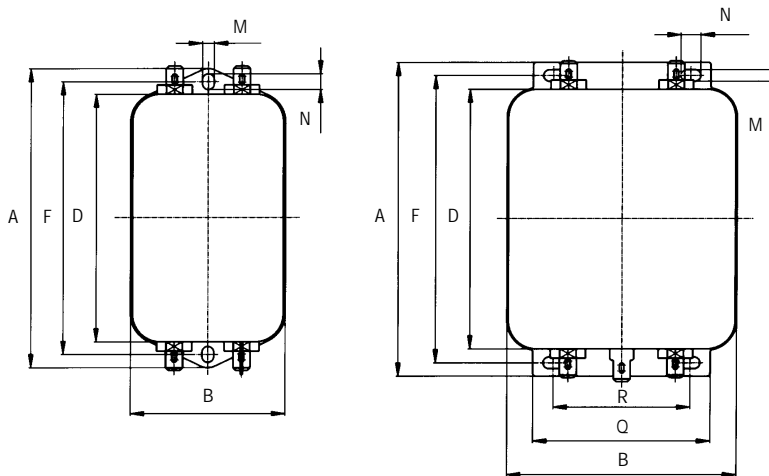

Housings P and Q

Housing L2

Cross reference list  
AWG to copper area in mm<sup>2</sup>

| Current ratings | AWG number | Cu mm <sup>2</sup> (approx) |
|-----------------|------------|-----------------------------|
| 1-3A            | 20         | 0.54                        |
| 6-10A           | 18         | 0.83                        |
| 12-16A          | 16         | 1.34                        |



# SCHAFFNER

Schaffner EMV AG CH-4542 Luterbach, Switzerland  
Tel: [+41] (32) 6816 626 Fax: [+41] (32) 6816 641 www.schaffner.com

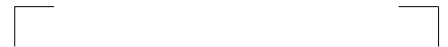

690-407E

Benteli Hallwag/January 1999

© 1995 Schaffner EMV. Specifications subject to change without notice. All trademarks recognised.



Schaffner is an ISO-registered company. Its products are designed and manufactured under the strict quality requirements of the ISO 9001 standard.

This document has been carefully checked. However, Schaffner does not assume any liability for errors or inaccuracies.