

tyco

Electronics

BCF Series

Very compact
3-Phase Filter Series
for universal application

*Sehr kompakter Dreiphasenfilter
für den universellen Einsatz*

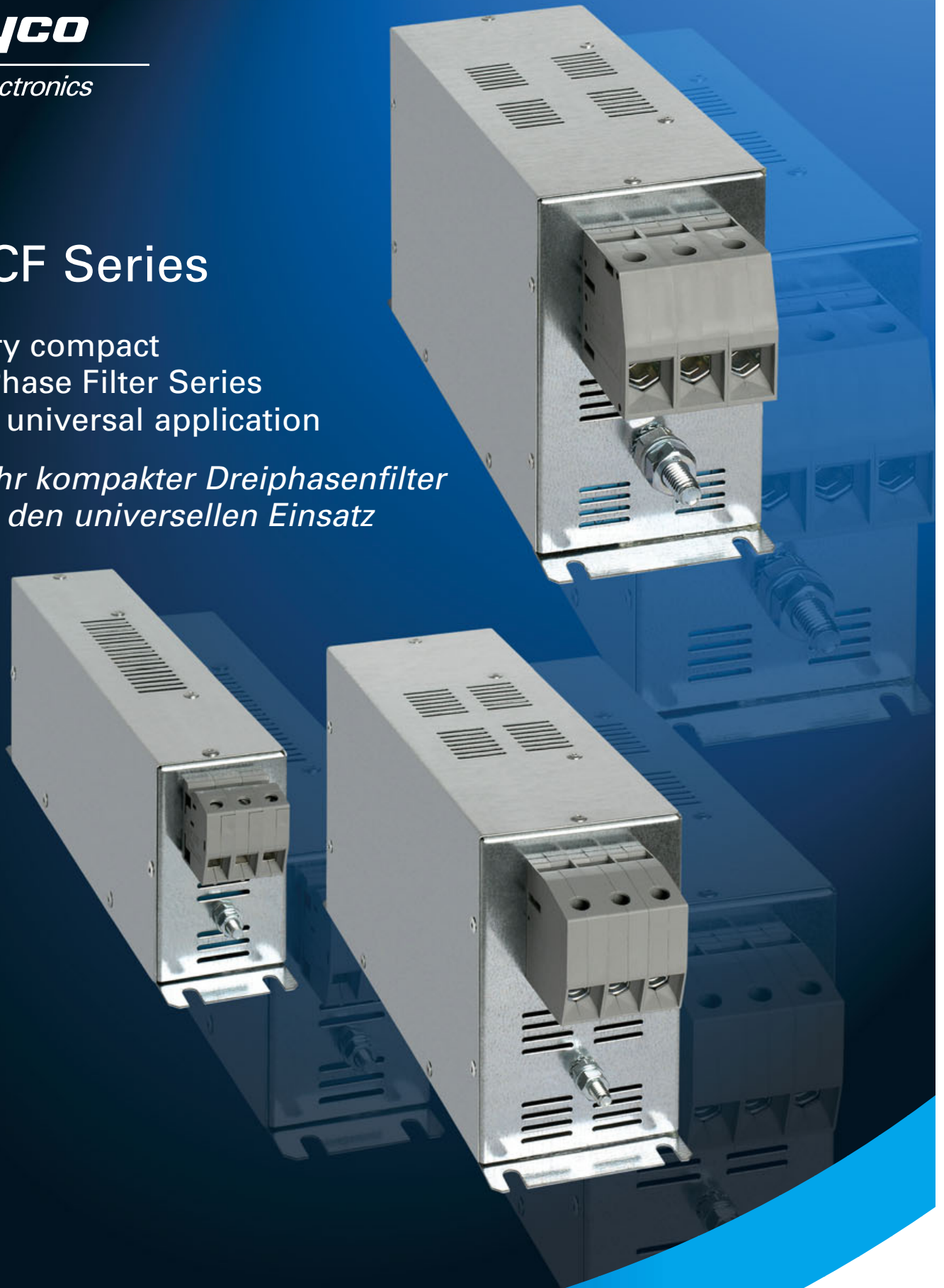

corcom

General Information / Allgemeine Informationen

- | | |
|--|--|
| ■ Very compact bookform filter | ■ <i>Sehr kompakter Buchform-Filter</i> |
| ■ Low weight design | ■ <i>Geringes Gewicht</i> |
| ■ Insulated, high quality safety terminals for in- and output | ■ <i>Isolierte, hoch qualitative Sicherheitsklemmen auf der Ein- und Ausgangsseite</i> |
| ■ For current rating up to 180 A | ■ <i>Für Stromstärken bis zu 180 A</i> |
| ■ Cost effective design | ■ <i>Kostenoptimiertes Design</i> |
| ■ Ideal for all kinds of industrial 3-phase applications requiring very high attenuation in the frequency range between 100 KHz and 30 MHz | ■ <i>Hervorragend geeignet für alle industriellen 3-Phasen-Anwendungen, die eine sehr hohe Einfügungsdämpfung im Frequenzbereich zwischen 100 KHz und 30 MHz benötigen</i> |
| ■ Very high common and differential mode performance over the whole frequency range | ■ <i>Sehr hohe asymmetrische und symmetrische Dämpfung über den gesamten Frequenzbereich</i> |

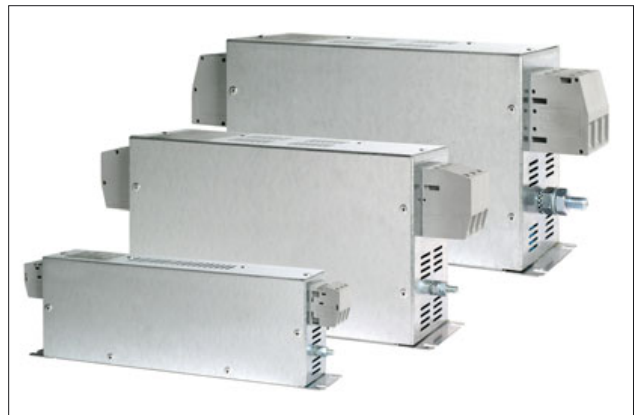

RoHS
Ready



Electrical Schematic / Elektrischer Schaltplan

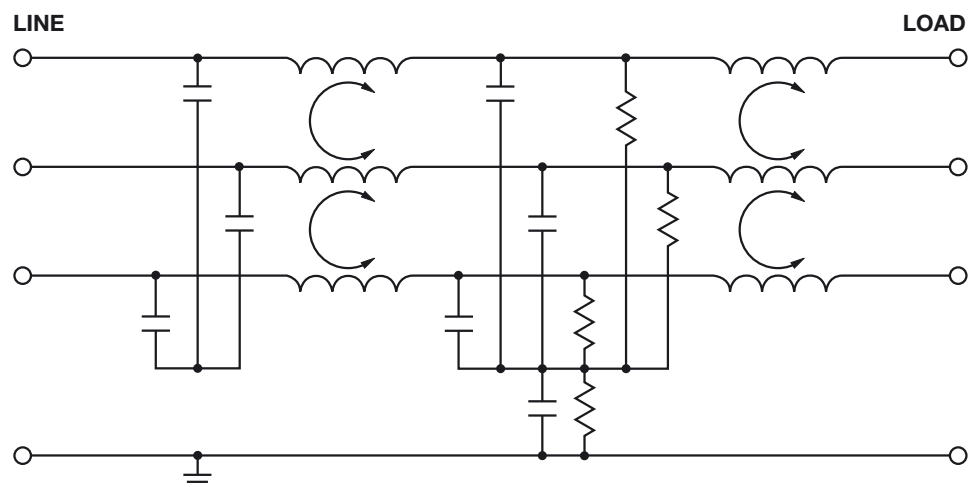

Electrical Specifications / Elektrische Eigenschaften

Maximum leakage current / Maximaler Ableitstrom:

@ 400 VAC 50 Hz: 30 mA under normal circumstances
(if 2 phases are interrupted, this leakage may rise to a significant higher level)

Hipot rating (one minute) / Prüfspannung (1 Minute):

line-to-ground 1850 VDC
line-to-line 1850 VDC

Operating frequency / Nennfrequenz:

DC to 60 Hz

Rated voltage (max.) / Nennspannung (max.):

480 VAC

Ordering Information / Bestellinformationen



Type	Order no.	Max. Current 50 °C / 40 °C	Inductance L	C _x	C _y
7BCF10	1609989-1	7 A / 8 A	2,44 mH	3,3 µF	2,0 µF
16BCF10	1609989-2	16 A / 18 A	2,32 mH	3,3 µF	2,0 µF
30BCF10	1609989-3	30 A / 33 A	1,61 mH	5,0 µF	2,1 µF
42BCF10	1609989-4	42 A / 46 A	1,14 mH	6,7 µF	2,2 µF
55BCF10	1609989-5	55 A / 61 A	1,80 mH	6,7 µF	2,2 µF
75BCF10	1609989-6	75 A / 83 A	1,08 mH	6,7 µF	2,2 µF
100BCF10	1609989-7	100 A / 110 A	0,82 mH	6,7 µF	2,2 µF
130BCF10	1609989-8	130 A / 143 A	0,56 mH	6,7 µF	2,2 µF
180BCF10	1609989-9	180 A / 198 A	0,72 mH	6,7 µF	2,2 µF

Mechanical Data / Mechanische Eigenschaften

Bottom view

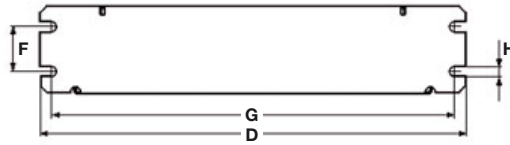

Side view

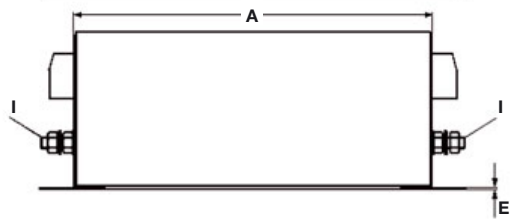

Front view

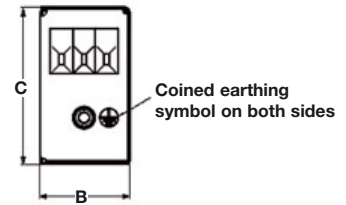

Top view



Type	A	B	C	D	E	F	G	H	GND (I)	Type of connection	Weight (kg)	Packing unit
7BCF10	160	40	70	190	0,8	20	180	4,5	M5	Terminal block 4 mm ²	0,7	1
16BCF10	220	45	70	250	0,8	25	235	5,4	M5	Terminal block 4 mm ²	1,1	1
30BCF10	240	50	85	270	0,8	30	255	5,4	M5	Terminal block 10 mm ²	1,5	1
42BCF10	280	50	85	310	0,8	30	295	5,4	M6	Terminal block 10 mm ²	1,7	1
55BCF10	220	85	90	250	1,0	60	235	5,4	M6	Terminal block 16 mm ²	2,4	1
75BCF10	240	80	135	270	1,0	60	255	6,5	M6	Terminal block 25 mm ²	3,2	1
100BCF10	240	90	150	270	1,0	65	255	6,5	M10	Terminal block 50 mm ²	4,2	1
130BCF10	240	90	150	270	1,0	65	255	6,5	M10	Terminal block 50 mm ²	4,4	1
180BCF10	350	120	170	380	1,0	102	365	6,5	M10	Terminal block 95 mm ²	6,2	1

All dimensions in mm

Typical Insertion Loss / Beispiel typischer Einfügungsdämpfung

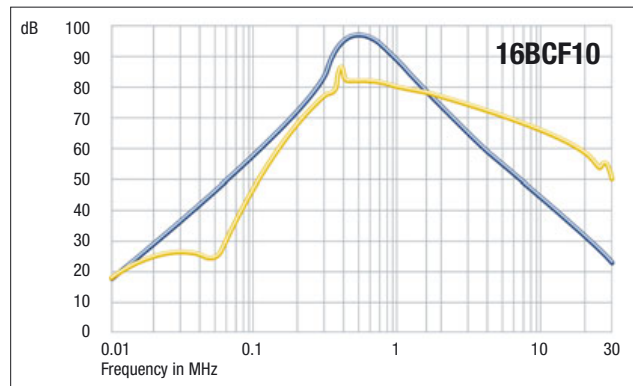
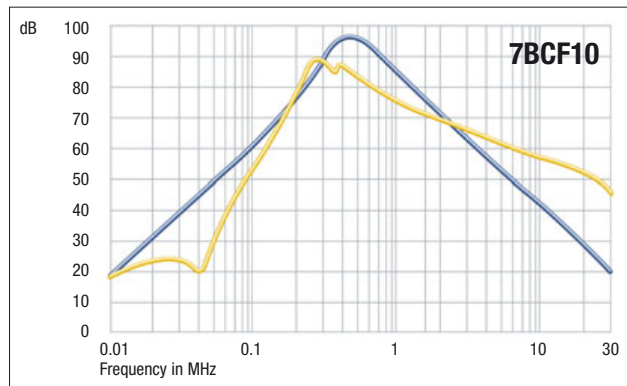

to be continued on next page/Fortsetzung auf folgender Seite

Typical Insertion Loss / Beispiel typischer Einfügungsdämpfung

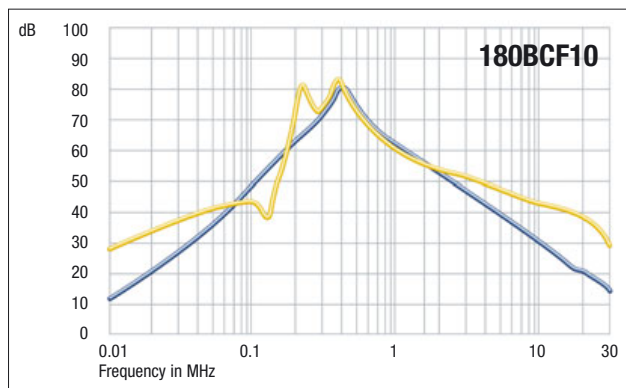
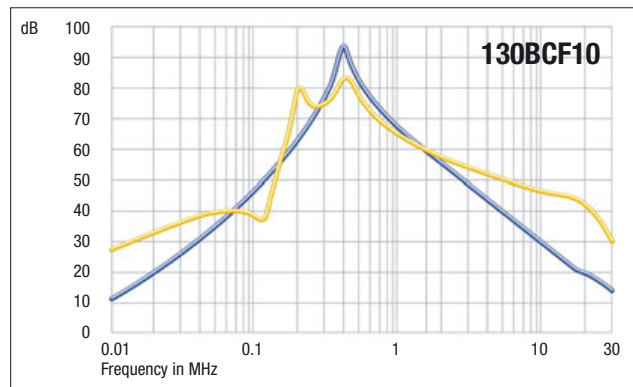
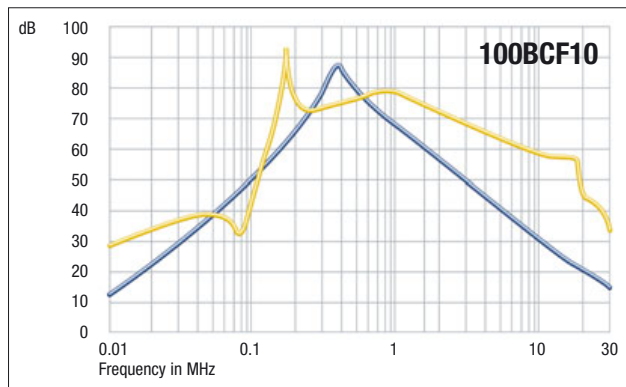
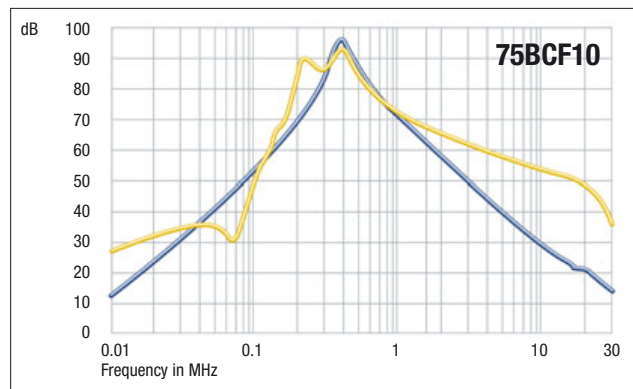
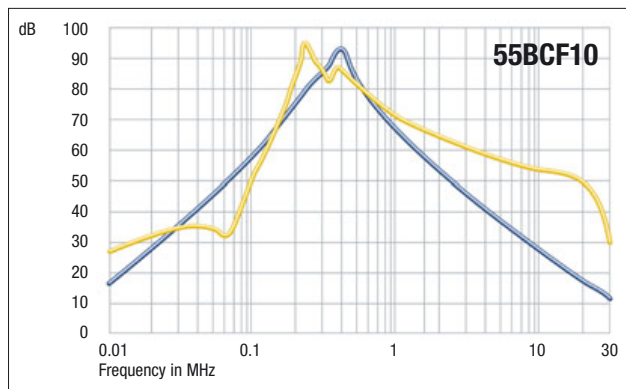
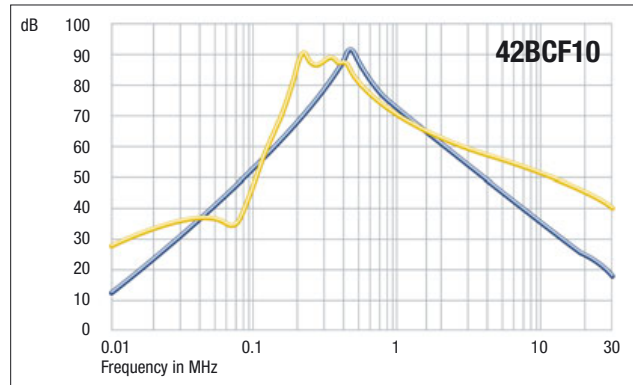
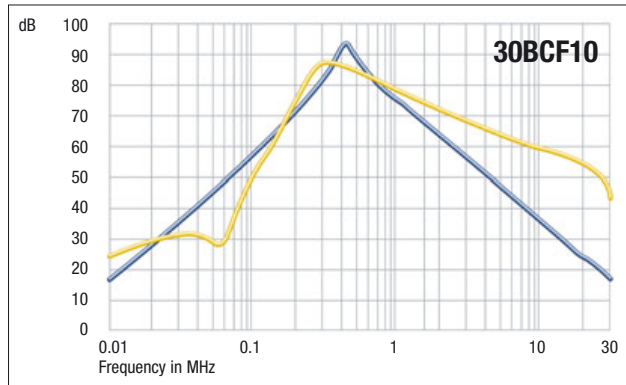

— sym.
— asym.

Measuring method: closed 50 Ω system

Austria – Vienna

Phone: +43-1-905-60-0
Fax: +43-1-905-60-1333

Product Information Center:

Phone: +43-1-905-60-1249
Fax: +43-1-905-60-1251

Belgium – Kessel-Lo

Phone: +32-16-352-300
Fax: +32-16-352-352

Bulgaria – Sofia

Phone: +359-2-971-2152
Fax: +359-2-971-2153

Czech Republic – Kurim

Phone: +420-5-41-162-111
Fax: +420-5-41-162-223

Product Information Center:

Phone: +420-5-41-162-113
Fax: +420-5-41-162-132

Denmark – Glostrup

Phone: +45-43-480-452
Fax: +45-43-441-414

Egypt – Cairo

Phone: +20-2-417-76-47
Fax: +20-2-419-23-34

Finland – Helsinki

Phone: +358-95-12-34-20
Fax: +358-95-12-34-250

France – Cergy-Pontoise Cedex

Phone: +33-1-3420-8888
Fax: +33-1-3420-8600

Product Information Center:

Phone: +33-1-3420-8686
Fax: +33-1-3420-8623

France Export Divisions –

Cergy-Pontoise Cedex
Phone: +33-1-3420-8866
Fax: +33-1-3420-8300

Germany – Bensheim**Tyco Electronics AMP GmbH**

Phone: +49-6251-133-0
Fax: +49-6251-133-1600

Product Information Center:

Phone: +49-6251-133-1999
Fax: +49-6251-133-1988

Germany – Langen**Tyco Electronics AMP GmbH**

Phone: +49-6103-709-0
Fax: +49-6103-709-1223

Germany – Niefern**Tyco Electronics pretema****GmbH & Co. KG**

Phone: +49-7233-69-0
Fax: +49-7233-69-100

Germany – Ottobrunn**Tyco Electronics Raychem GmbH**

Phone: +49-89-6089-0
Fax: +49-89-6096-345

Great Britain –

Stanmore Middlesex
Phone: +44-8706-080-208
Fax: +44-208-954-6234

Product Information Center:

Freephone GB: 0800-267-666
Phone: +44-208-420-8341
+44-208-420-8343
Fax: +44-208-420-8081

Greece – Athens

Phone: +30-210-9370-396/397
Fax: +30-210-9370-655

Hungary – Budapest

Phone: +36-1-289-1000
Fax: +36-1-289-1010

Product Information Center:

Phone: +36-1-289-1016
Fax: +36-1-289-1017

Ireland – Dublin

Phone: +353-1-820-3000
Fax: +353-1-820-9790

Israel – Yokneam

Phone: +972-4-959-0508
Fax: +972-4-959-0506

Italy – Collegno (Torino)

Phone: +39-011-4012-111
Fax: +39-011-4031116

Product Information Center:

Phone: +39-011-4012-360
Fax: +39-011-40287360

Lithuania – Vilnius

Phone: +370-5-2131-402
Fax: +370-5-2131-403

Netherlands – 's-Hertogenbosch

Phone: +31-73-6246-246
Fax: +31-73-6212-365

Product Information Center:

Phone: +31-73-6246-999
Fax: +31-73-6246-998

Norway – Nesbru

Phone: +47-66-77-88-86
Fax: +47-66-77-88-55

Poland – Warsaw

Phone: +48-22-4576-700
Fax: +48-22-4576-720

Product Information Center:

Phone: +48-22-4576-704
Fax: +48-22-4576-720

Romania – Bucharest

Phone: +40-21-311-3479 + 3596
Fax: +40-21-312-0574

Russia – Moscow

Phone: +7-095-926-55-06...09
Fax: +7-095-926-55-05

Russia – St. Petersburg

Phone: +7-812-718-8192
Fax: +7-812-718-8193

Slovenia – Ljubljana

Phone: +386-1561-3270
Fax: +386-1561-3240

South Africa – Port Elizabeth

Phone: +2741-503-4500
Fax: +2741-581-0440

Spain – Barcelona

Phone: +34-93-291-0330
Fax: +34-93-201-7879

Sweden – Upplands Väsby

Phone: +46-8-50-72-50-00
Fax: +46-8-50-72-50-01

Switzerland – Steinach

Phone: +41-71-447-0447
Fax: +41-71-447-0444

Turkey – Istanbul

Phone: +90-212-281-8181...3
+90-212-282-5130/5430
Fax: +90-212-281-8184

Ukraine – Kiev

Phone: +380-44-206-2265
Fax: +380-44-206-2264