



Gas Discharge Tubes

Tyco Electronics' GDTs (Gas Discharge Tubes) are placed in front of, and in parallel with, sensitive telecom equipment such as power lines, communication lines, signal lines and data transmission lines to help protect them from damage caused by transient surge voltages that may result from lightning strikes and equipment switching operations. These devices do not influence the signal in normal operation. However, in the event of an overvoltage surge, such as a lightning strike, the GDT switches to a low impedance state and diverts the energy away from the sensitive equipment.

Our GDTs offer a high level of surge protection, a broad voltage range, low capacitance, and many form factors including new surface mount devices, which makes them suitable for applications such as MDF (Main Distribution Frame) modules, high data-rate telecom applications (e.g. ADSL, VDSL), and surge protection on power lines. Their low capacitance also results in less signal distortion. When used in a coordinated circuit protection solution with PolySwitch devices, they can help equipment manufacturers meet stringent safety regulatory standards.



Benefits

- Helps provide overvoltage fault protection against damage caused by high energy surges
- Suitable for use in sensitive equipment due to impulse sparkover response
- Suitable for high-frequency applications
- Highly reliable performance
- **New surface-mount devices for automated manufacturing**

Features

- RoHS compliant
- Halogen free
(refers to: Br \leq 900ppm, Cl \leq 900ppm, Br+Cl \leq 1500ppm)
- Wide range of voltages (75V-600V)
- Wide range of form factors
(3mm, 5mm, 6mm, 7mm, 8mm diameter devices)
- Low capacitance and insertion loss
- Crowbar device with low arc voltage
- High accuracy spark-over voltages for high precision designs
- Devices tested per ITU K.12 recommendations
- Various lead configurations and surface-mount options
- Optional fail-short mechanism
- Non radioactive materials

Applications

- Telecommunications
 - MDF modules, xDSL equipment, RF systems, antenna, base stations
- Industrial and Consumer Electronics
 - Power supplies, surge protectors, alarm systems, irrigation systems

Table G1 Device Voltage Ratings for “R” Series Gas Discharge Tubes
Two Electrode Configuration for R Series GDTs

Part Number	DC Sparkover Voltage	Impulse Sparkover Voltage
	@ 100V/s ± 20% Tolerance	@ 1kV/μs
	75*	600
	90	600
	140	600
GTC23-XXXM-R01-2	150	600
GTC23-XXXM-R01-2	200	700
	230	700
	300	900
	350	1000
	400	1000

* DCSO 60-105

Part Number	DC Sparkover Voltage	Impulse Sparkover Voltage		DC Holdover Voltage	On-State Voltage
	@ 100V/s ± 20% Tolerance	@ 100V/μs	@ 1kV/μs	Per ITU K.12	Nominal (@1A) (V)
	75	450	550	<52	20
	90	450	550	<52	20
	140	500	600	<80	20
	150	500	600	<80	20
	200	600	700	<135	20
GTC25-XXXM-R02	230	600	700	<135	20
GTC26-XXXM-R05	250	600	700	<135	20
GTC28-XXXM-R05	260	700	800	<135	20
GTC28-XXXM-R10	300	800	900	<150	20
GTC28-XXXM-R20**	350	900	1000	<150	20
	400	900	1000	<150	20
	420	900	1000	<150	20
	470	1050	1150	<150	20
	500	1100	1200	<150	20
	550	1300	1400	<150	20
	600	1300	1400	<150	20

** GTC28-XXXM-R20 parts only up to 350V

Three Electrode Configuration for R series GDTs

Part Number	DC Sparkover Voltage (A-E) (B-E)	Impulse Sparkover Voltage (A-E) (B-E)		DC Holdover Voltage	On-State Voltage
	@ 100V/s ± 20% Tolerance	@ 100V/μs	@ 1kV/μs	Per ITU K.12	Nominal (@1A) (V)
	75	450	550	<52	20
	90	450	550	<52	20
	140	500	600	<80	20
	150	500	600	<80	20
	200	600	700	<135	20
GTC35-XXXM-R05	230	600	700	<135	20
GTC36-XXXM-R05	250	600	700	<135	20
GTC36-XXXM-R10	260	700	800	<135	20
GTC37-XXXM-R10	300	800	900	<150	20
GTC38-XXXM-R10	350	900	1000	<150	20
	400	900	1000	<150	20
	420	900	1000	<150	20
	470	1050	1150	<150	20
	500	1100	1200	<150	20
	550	1300	1400	<150	20
	600	1300	1400	<150	20

Table G2 Device Surge Rating, Capacitance, Insulation Resistance, and Agency Approval for "R" Series Gas Discharge Tubes

Two Electrode Configuration for R Series GDTs

Part Number	Impulse Discharge Current		Impulse Withstand Voltage	Capacitance	Insulation Resistance	UL Rating
	8x20µs 10 hits (5 hits each polarity)	8x20µs 300 hits (150 hits each polarity)	10x700µs 10 hits (5 times each polarity)	@ 1MHz	@ 100V _{DC} *	UL497B #E179610
GTCX23-XXXM-R01-2	1kA	100A	4kV	<0.5pF	1,000 (MΩ)	All Devices
GTCX23-XXXM-R01-2	1kA	100A	6kV [†]	<0.5pF	1,000 (MΩ)	All Devices

* Devices <=150V measured @ 50V_{DC}
 † Effective output impedance: 40ohms.

Part Number	Impulse Discharge Current	Impulse Life	AC Discharge Current (1sec duration; 10 hits)	Capacitance	Insulation Resistance	UL Rating
	8x20µs 10 hits	10x1000µs 300 hits	@ 50 Hz	@ 1MHz	@ 100V	UL497B #E179610
GTCX25-XXXM-R02	2.5kA	100A	2.5Arms	<1pF	10,000 (MΩ)	All Devices
GTCX26-XXXM-R05	5kA	100A	5Arms	<1pF	10,000 (MΩ)	All Devices
GTCX28-XXXM-R05	5kA	100A	5Arms	<1pF	10,000 (MΩ)	All Devices
GTCX28-XXXM-R10	10kA	100A	10Arms	<1pF [‡]	10,000 (MΩ)	All Devices
GTCX28-XXXM-R20	20kA	100A	20Arms	<1.5pF	10,000 (MΩ)	All Devices

‡ < 1.2pF for 75V and 90V devices.

Three Electrode Configuration for R series GDTs

Part Number	Impulse Discharge Current (A+B-E)	Impulse Life (A+B-E)	AC Discharge Current (1sec duration; 10 hits) (A+B-E)	Capacitance	Insulation Resistance	UL Rating
	8x20µs 10 hits	10x1000µs 300 hits	@ 50 Hz	@ 1MHz	@ 100V**	UL497B #E179610
GTCX35-XXXM-R05	5kA	100A	5Arms	<1pF	10,000 (MΩ)	All Devices
GTCX36-XXXM-R05	5kA	200A	5Arms	<1pF	10,000 (MΩ)	All Devices
GTCX36-XXXM-R10	10kA	200A	10Arms	<1pF	10,000 (MΩ)	All Devices
GTCX37-XXXM-R10	10kA	200A	10Arms	<1pF	10,000 (MΩ)	All Devices
GTCX38-XXXM-R10	10kA	200A	10Arms	<1pF	10,000 (MΩ)	All Devices

** Insulation resistance measured at 50V for devices less than 150V.
 Insulation resistance measured at 250V for devices more than 500V.

Figure G1-G2 Typical Circuits for "R" Series Gas Discharge Tubes

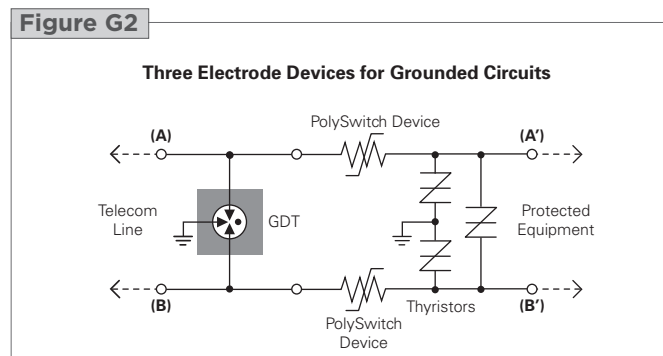
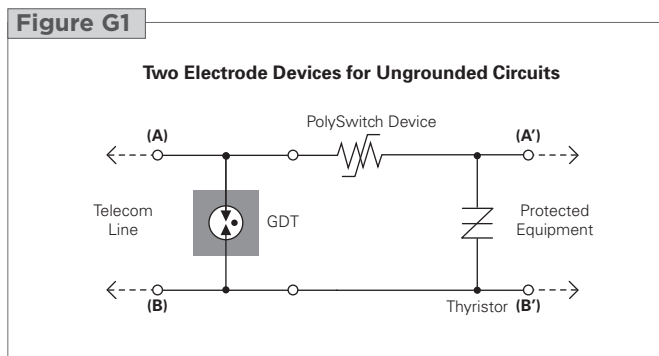
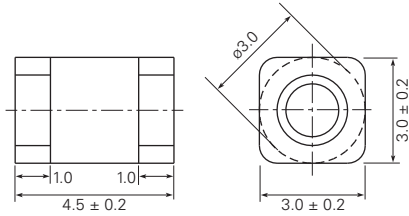

Figure G3-G10 Dimensions for "R" Series Gas Discharge Tubes

Figure G3 Two Electrode 3mm Product Dimensions

**Surface-mount
(GTCS23-XXXM-R01)**



**Pad Layout - Surface-mount Devices
(GTCS23-XXXM-R01)**

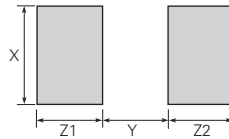

	X	Y	Z1	Z2
	Nom.	Nom.	Nom.	Nom.
mm	3.0	2.0	2.0	2.0
in*	(0.118)	(0.079)	(0.079)	(0.079)

* The dimensions in inches are rounded approximations.

**Chip GDT
(GTCC23-XXXM-R01)**

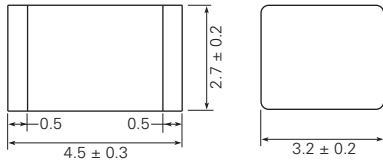

**Pad Layout - Chip GDT Devices
(GTCC23-XXXM-R01)**

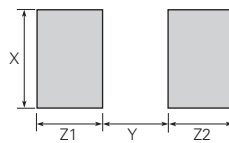

	X	Y	Z1	Z2
	Nom.	Nom.	Nom.	Nom.
mm	3.5	2.7	2.0	2.0
in*	(0.138)	(0.106)	(0.079)	(0.079)

* The dimensions in inches are rounded approximations.

Figure G4 Two Electrode 5mm Product Dimensions

**Axial Leads
(GTCA25-XXXM-R02)**

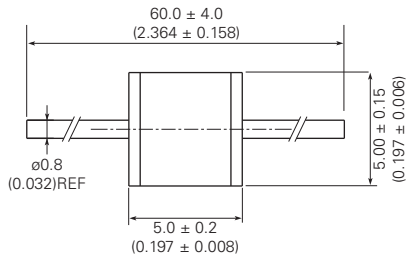

**No Leads
(GTCN25-XXXM-R02)†**

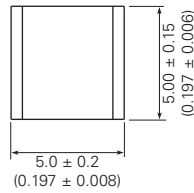

**Surface-mount
(GTCS25-XXXM-R02)**

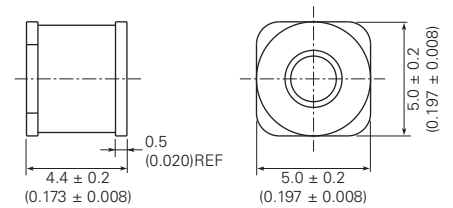

**Pad Layout - Surface-mount Devices
(GTCS25-XXXM-R02)**

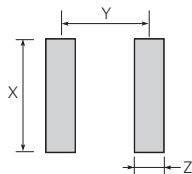

	X	Y	Z
	Nom.	Nom.	Nom.
mm	6.0	3.9	1.3
in*	(0.197)	(0.154)	(0.051)

* The dimensions in inches are rounded approximations.

† Parts with no leads are not solderable and are meant for insertion into magazine clips.

Figure G3-G10 Dimensions for "R" Series Gas Discharge Tubes

Cont'd

Figure G5 Two Electrode 6mm Product Dimensions

**Axial Leads
(GTCA26-XXXM-R05)**

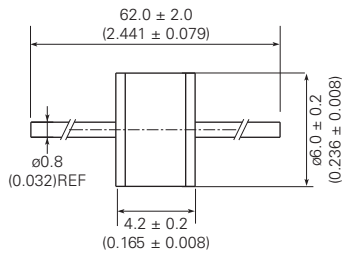

**No Leads
(GTCN26-XXXM-R05)†**

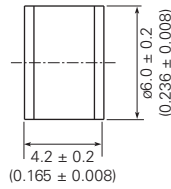

**Surface-mount
(GTCS26-XXXM-R05)**

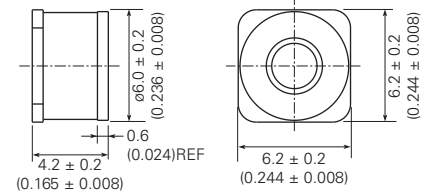

**Pad Layout - Surface-mount Devices
(GTCS26-XXXM-R05)**

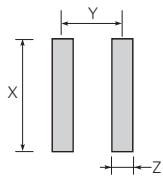

	X	Y	Z
	Nom.	Nom.	Nom.
mm	7.0	3.7	1.3
in*	(0.276)	(0.146)	(0.051)

* The dimensions in inches are rounded approximations.
† Parts with no leads are not solderable and are meant for insertion into magazine clips.

Figure G6 Two Electrode 8mm Product Dimensions

**Axial Leads
(GTCA28-XXXM-R05, R10 & R20)**

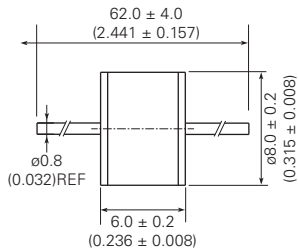

**No Leads
(GTCN28-XXXM-R05, R10 & R20)†**

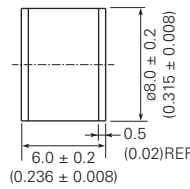

**Surface-mount
(GTCS28-XXXM-R05, R10 & R20)**

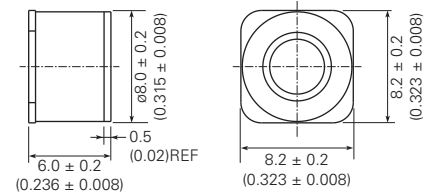

**Pad Layout - Surface-mount Devices
(GTCS28-XXXM-R05, R10 & R20)**

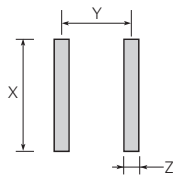

	X	Y	Z
	Nom.	Nom.	Nom.
mm	9.0	5.6	1.2
in*	(0.354)	(0.22)	(0.047)

* The dimensions in inches are rounded approximations.
† Parts with no leads are not solderable and are meant for insertion into magazine clips.

Figure G7 Three Electrode 5mm Product Dimensions

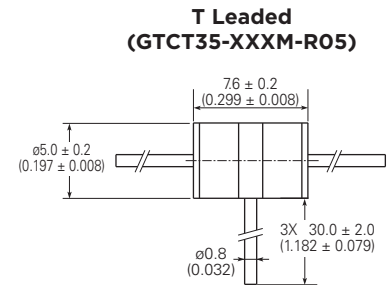
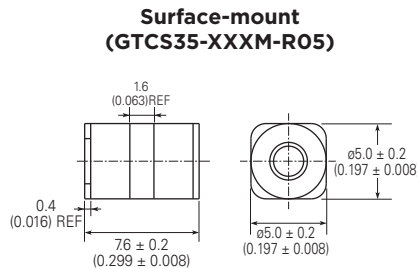
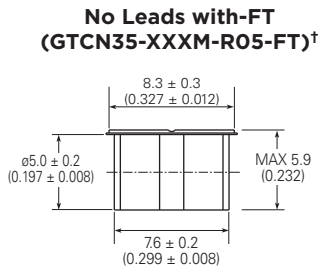
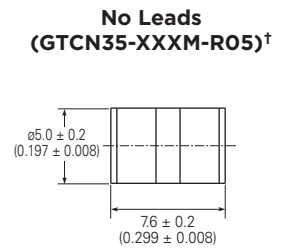
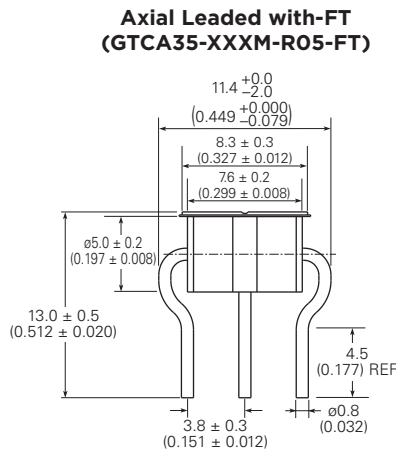
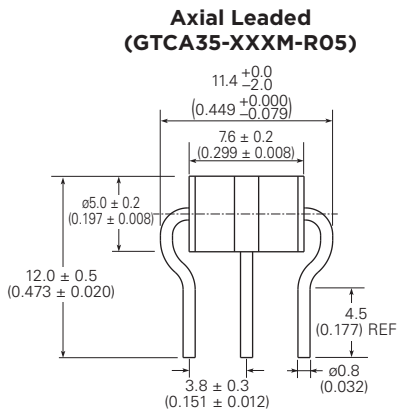

Pad Layout - Surface-mount Devices (GTCS35-XXXM-R05)

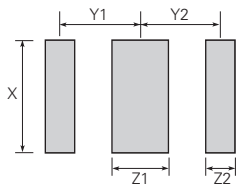

	X	Y1	Y2	Z1	Z2
	Nom.	Nom.	Nom.	Nom.	Nom.
mm	6.0	3.6	3.6	2.5	1.3
in*	(0.236)	(0.142)	(0.142)	(0.098)	(0.051)

* The dimensions in inches are rounded approximations.

† Parts with no leads are not solderable and are meant for insertion into magazine clips.

Figure G3-G10 Dimensions for "R" Series Gas Discharge Tubes

Cont'd

Figure G8 Three Electrode 6mm Product Dimensions

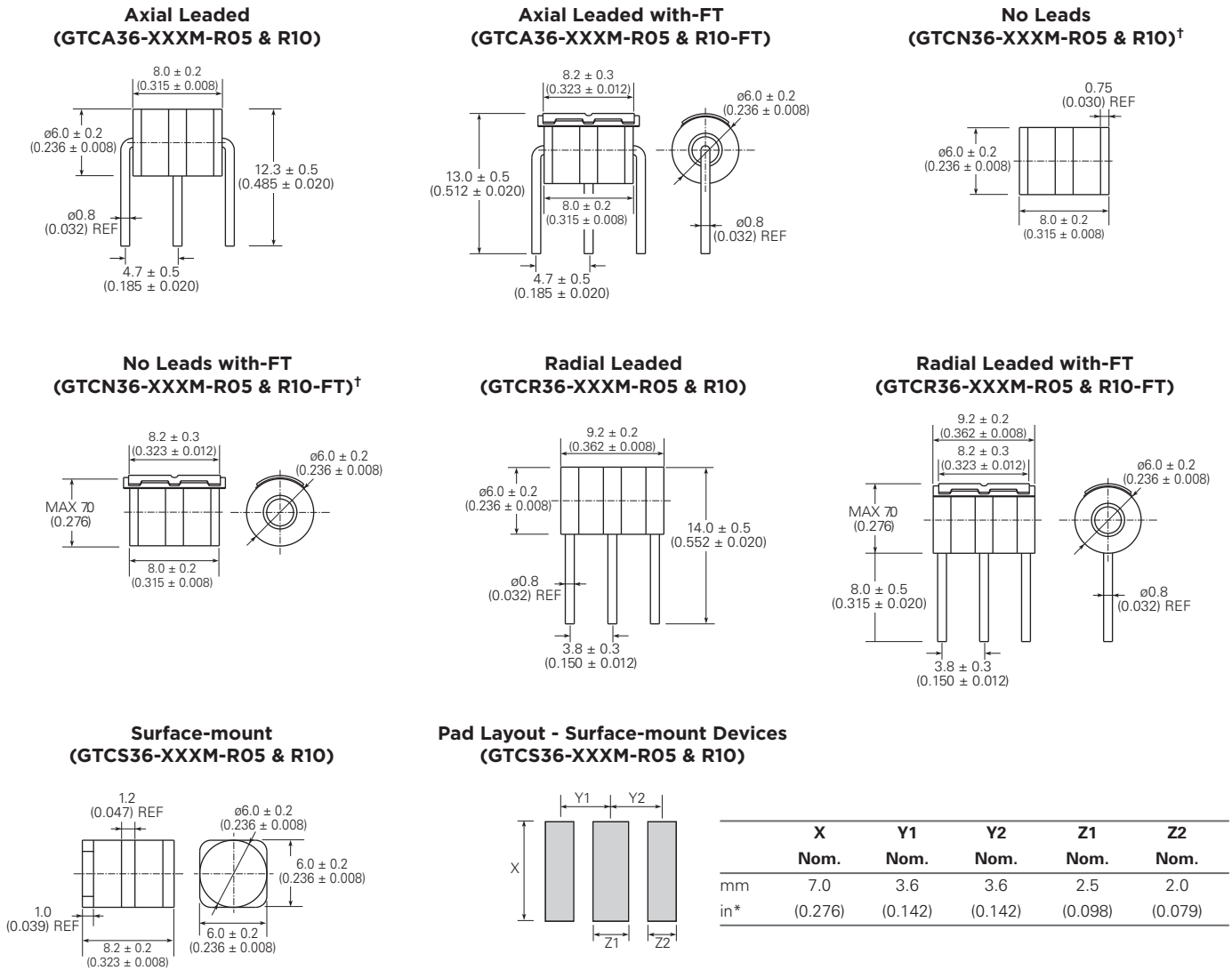

* The dimensions in inches are rounded approximations.
 † Parts with no leads are not solderable and are meant for insertion into magazine clips.

Figure G9 Three Electrode 7mm Product Dimensions

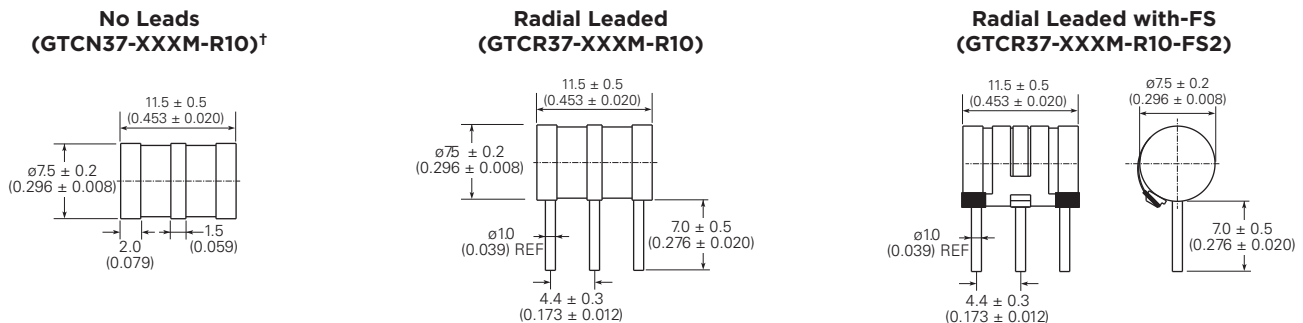

† Parts with no leads are not solderable and are meant for insertion into magazine clips.

Figure G10 Three Electrode 8mm Product Dimensions

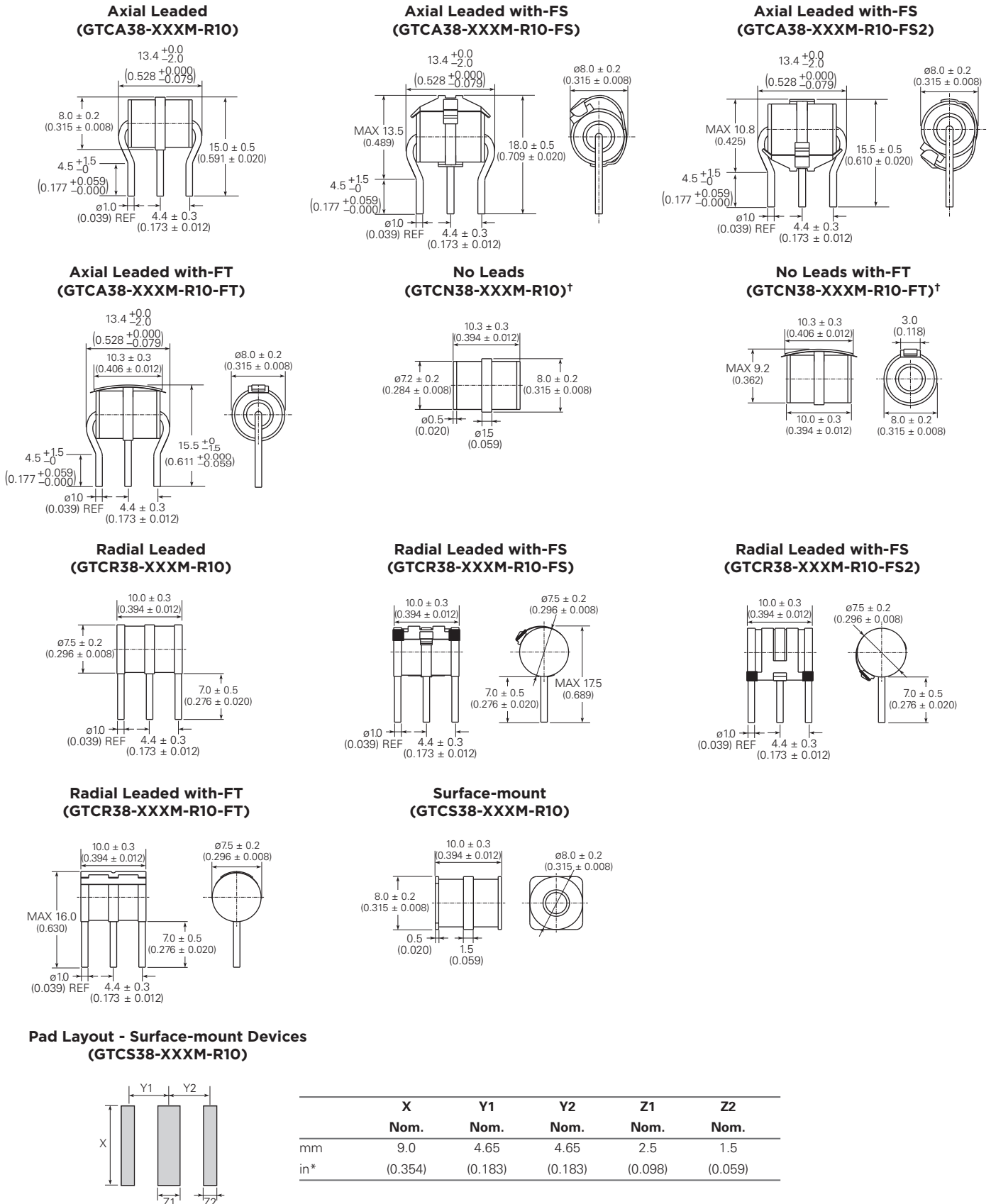

* The dimensions in inches are rounded approximations.
 † Parts with no leads are not solderable and are meant for insertion into magazine clips.

Fail-Short Mechanism for Gas Discharge Tubes

Fail-Short Mechanism (FS)

The FS fail-short mechanism is a short circuit spring mounted onto a solder pellet located at the center electrode of the gas tube. Under normal operating conditions, the pellet is positioned to make the spring float above the outer electrodes, as shown in Figure G11.

When a prolonged discharge event causes the gas tube temperature to reach the melting point of the solder, the pellet softens allowing the short circuit spring to contact with both outer electrodes. This process results in a permanent short-circuit between all three electrodes creating a low resistance path that conducts the fault current to ground without generating a significant amount of heat.

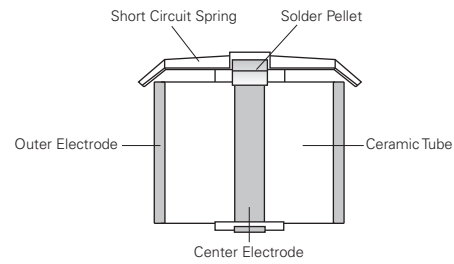

Figure G11

Fail-Short Mechanism (FT)

The FT fail-short mechanism is a short circuit spring with a piece of plastic foil spot welded onto the center electrode. Under normal operating conditions, the plastic foil makes the spring insulated from the two outer electrodes.

When a prolonged discharge event causes the gas tube temperature to reach the melting point of the plastic foil, the plastic foil melts allowing the short circuit spring to contact both outer electrodes. This process results in a permanent short-circuit between all three electrodes creating a low resistance path that conducts the fault current to ground without generating a significant amount of heat.

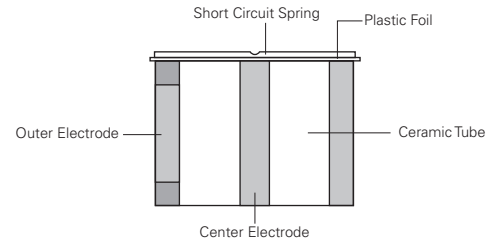

Figure G12

Operation and Storage Temperatures for Gas Discharge Tubes

Operation Temperature Range

Models without Fail-Short Mechanism : -40°C/+90°C

Models with Fail-Short Mechanism : -20°C/+65°C

Storage Temperature Range

Models without Fail-Short Mechanism : -40°C/+90°C

Models with Fail-Short Mechanism : -20°C/+65°C

Packaging Information for “R” Series Gas Discharge Tubes

Part Description	Parts in Bulk		Parts in Tape and Reel	
	Min Order Quantity	Box Quantity	Tape & Reel Min Order Quantity	Box Quantity
3mm 2Pole Surface-mount	-	-	2000	16000
5mm 2Pole No leads	5000	20000	-	-
5mm 2Pole, Leads	1000	5000	-	-
5mm 2Pole Surface-mount	5000	20000	1500	12000
6mm 2Pole No leads	2000	10000	-	-
6mm 2Pole, Leads	1000	5000	-	-
6mm 2Pole Surface-mount	2000	10000	750	6000
8mm 2pole No leads	2000	10000	-	-
8mm 2Pole, Leads	1000	5000	-	-
8mm 2Pole Surface-mount	2000	10000	400	2400
5mm 3Pole No leads	2500	10000	-	-
5mm 3Pole, Leads	1000	5000	-	-
5mm 3Pole Surface-mount	2500	10000	1000	8000
6mm 3Pole No leads	2500	10000	-	-
6mm 3Pole, Leads	1000	5000	-	-
6mm 3Pole Surface-mount	2500	10000	750	6000
7mm 3Pole, Leads	1000	5000	-	-
8mm 3Pole No leads	1000	10000	-	-
8mm 3Pole, Leads	1000	5000	-	-
8mm 3Pole Surface-mount	1000	10000	500	2500

Installation for Gas Discharge Tubes

Care should be taken when installing Gas Discharge Tubes equipped with Fail-Short Mechanisms into arrester magazines, printed circuit boards, etc. Too much downward pressure may force the short circuit spring through the thin insulation tube creating a shorted condition.

Solder Reflow Recommendations for Surface-mount GDT Devices

Surface-mount GDTs can be soldered using standard Pb-free reflow profile.

Part Numbering System for "R" Series Gas Discharge Tubes

Two Electrode GDT - Example Part Number for R Series Devices

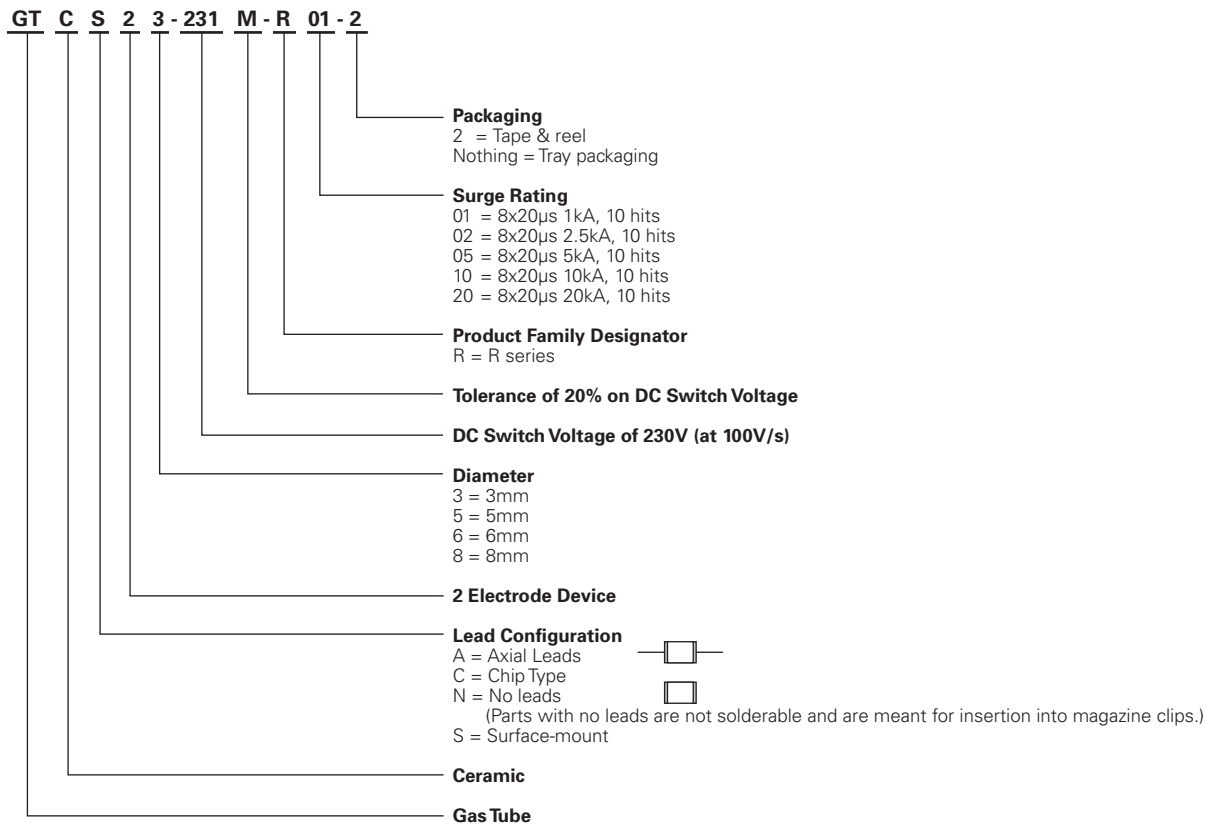

NOTE: GTCS23-XXXM-R01 and GTCC23-XXXM-R01 parts available only in surface-mount and tape and reel packaging

Part Numbering System for "R" Series Gas Discharge Tubes

Cont'd

Three Electrode GDT - Example Part Number for R Series Devices

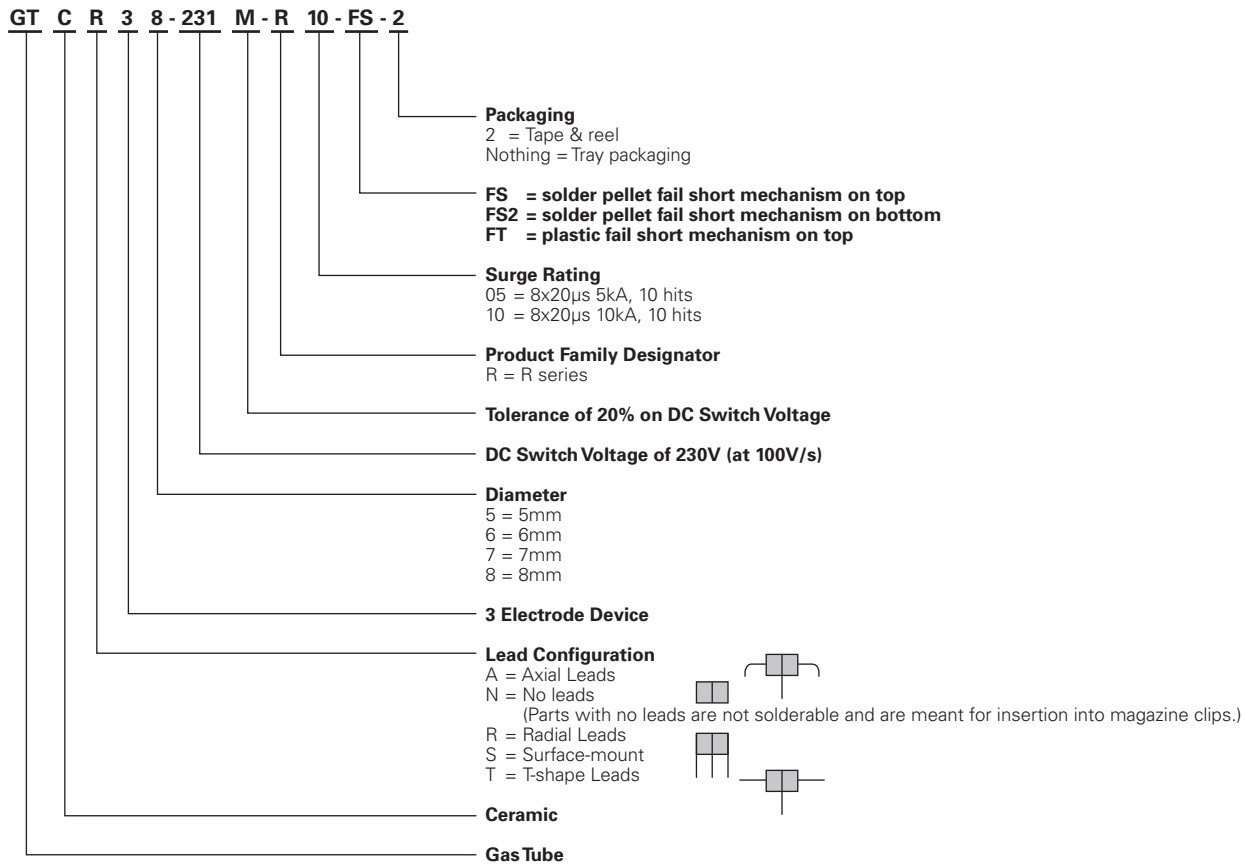

8

Marking Reference Guide - Example

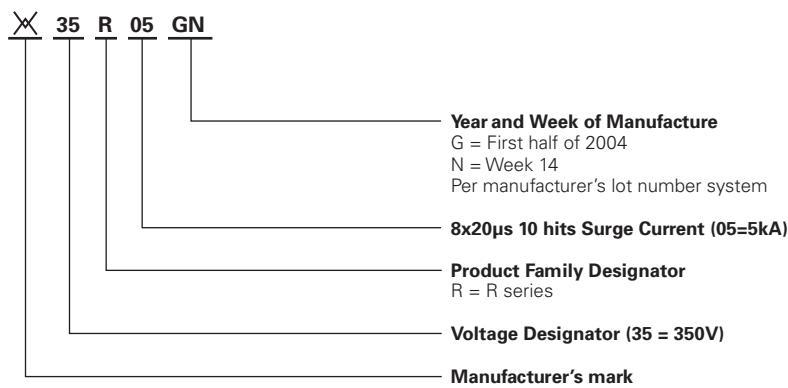

NOTES: GTCS23-XXXM-R01 and GTCC23-XXXM-R01 parts will have no marking.
 Devices with no leads (GTCNxx-xxxx-xx) are not able to be soldered as their electrodes are Nickel plated.
 They should be installed by insertion into a magazine clip.

Warning :

- Users should independently evaluate the suitability of and test each product selected for their own application.
- Operation beyond the maximum ratings or improper use may result in device damage and possible electrical arcing and flame.
- The devices are intended for protection against damage caused by occasional overvoltage fault conditions and should not be used when repeated fault conditions or prolonged trip events are anticipated.
- Device performance can be impacted negatively if devices are handled in a manner inconsistent with recommended electronic, thermal, and mechanical procedures for electronic components.

