



## Features

- Balanced Mini-TRIGARD™
- 5 mm diameter, 7.5 mm long
- UL Recognized 
- RoHS compliant\* versions available

## Applications

- Telecommunications
- Industrial electronics
- Commercial electronics
- Consumer electronics
- Automotive, aircraft, military electronics

# 2036 Series - Miniature 3-Pole Gas Discharge Tube

### Characteristics

Test Methods per ITU-T (CCITT) K.12, IEEE C62.31

Characteristic	Model No.					
	2036-07	2036-09	2036-15	2036-20	2036-23	2036-25
DC Sparkover $\pm 20\%$ @ 100 V/s	75 V	90 V	150 V	200 V	230 V	250 V
Impulse Sparkover	250 V	250 V	350 V	425 V	450 V	475 V
	100 V/ $\mu$ s	525 V	550 V	500 V	575 V	600 V
1000 V/ $\mu$ s						

Characteristic	Model No.					
	2036-30	2036-35	2036-40	2036-42	2036-47	2036-60
DC Sparkover $\pm 20\%$ @ 100 V/s	300 V	350 V	400 V	420 V	470 V	600 V
Impulse Sparkover	500 V	600 V	650 V	675 V	750 V	850 V
	100 V/ $\mu$ s	650 V	750 V	825 V	850 V	950 V
1000 V/ $\mu$ s						

Impulse Transverse Delay .....	100 V/ $\mu$ s .....	< 75 ns
Insulation Resistance .....	100 V (50 V for Model 2036-07 & 2036-09) .....	> $10^{10} \Omega$
Glow Voltage .....	10 mA .....	~ 70 V
Arc Voltage .....	1 A .....	~ 10 V
Glow-Arc Transition Current .....		< 0.5 A
Capacitance .....	1 MHz .....	< 2 pF
DC Holdover Voltage <sup>1</sup> .....	135 V, (52 V for Model 2036-07 & 2036-09, .....	< 150 ms
Impulse Discharge Current .....	20000 A, 8/20 $\mu$ s <sup>2</sup> .....	1 operation minimum
	10000 A, 8/20 $\mu$ s .....	> 10 operations
	200 A, 10/1000 $\mu$ s .....	> 300 operations
	200 A, 10/700 $\mu$ s .....	> 500 operations
Alternating Discharge Current .....	20 Arms, 1 s <sup>2</sup> .....	> 1 operation minimum
	10 Arms, 1 s .....	> 10 operations
Operating Temperature .....		-55 to +85 °C

Optional Switch-Grade Fail-Short device available.

### Notes:

- **UL recognized component, UL File E153537.**
- Model number marking on tube: xxx V.
- The rated discharge current for Mini-TRIGARD™ Gas Discharge Tubes is the total current equally divided between each line to ground.
- Sparkover limits after life  $\pm 25\%$ , IR  $> 10^{10} \Omega$  (-25 %, +30 % for Model 2036-07, 2036-09 and 2036-60).
- Operating characteristics per RUS PE-80 and Telcordia GR 1361 available, contact factory.
- Line to Line voltage is approximately 1.8 to 2 times the stated Line to Ground breakdown voltage.
- At delivery AQL 0.65 Level II, DIN ISO 2859.

<sup>1</sup> Network applied.

<sup>2</sup> DC Sparkover may exceed  $\pm 25\%$  after discharge, but will continue to protect without venting.

# 2036 Series - Miniature 3-Pole Gas Discharge Tube

**BOURNS®**

## Product Dimensions

**2036-XX-A**

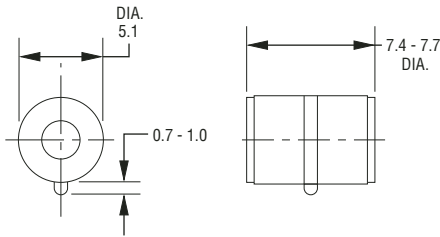

**2036-XX-B2 — 0.8 mm dia. lead wire**  
**2036-XX-C2 — 1.0 mm dia. lead wire\***

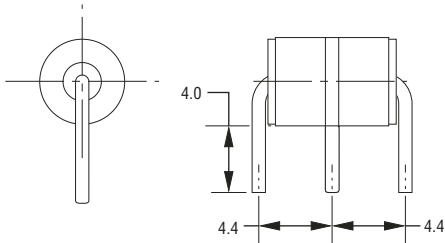

**2036-XX-B3 — 0.8 mm dia. lead wire**  
**2036-XX-C3 — 1.0 mm dia. lead wire\***

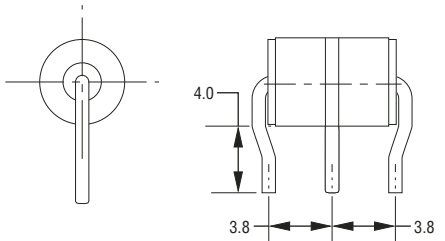

**2036-XX-B9 — 0.8 mm dia. lead wire**  
**2036-XX-C9 — 1.0 mm dia. lead wire\***

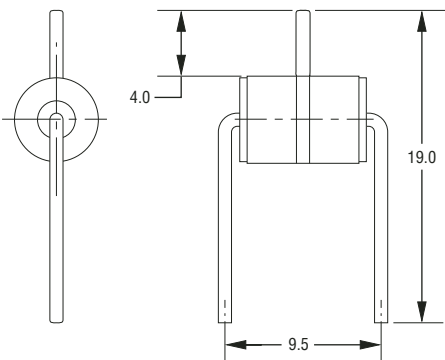

**2036-XX-B — 0.8 mm dia. lead wire**  
**2036-XX-C — 1.0 mm dia. lead wire\***

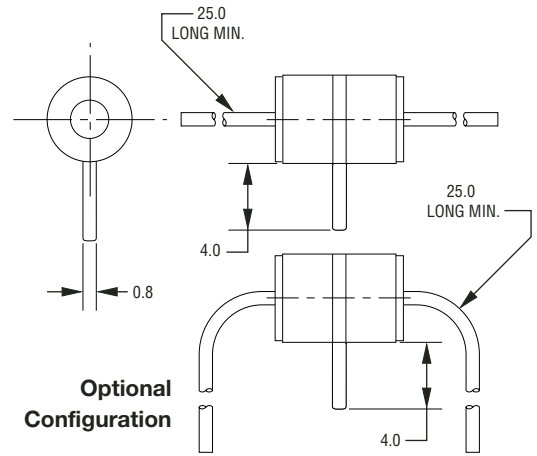

**2036-XX-B8 — 0.8 mm dia. lead wire**  
**2036-XX-C8 — 1.0 mm dia. lead wire\***

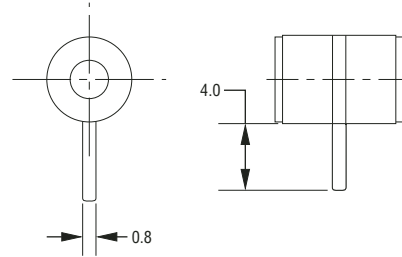

**FAIL-SHORT CONFIGURATION**  
**2036-XX-B2F SHOWN**

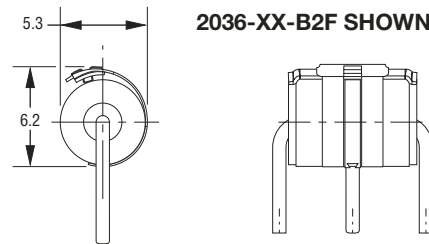

**CENTER ELECTRODE LEAD: C-CONFIGURATION**

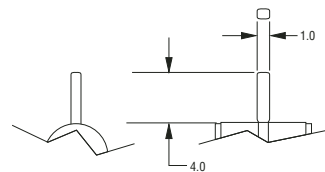

DIMENSIONS = MILLIMETERS

\*Center Electrode Lead: See Center Lead C-Configuration detail. Specifications are subject to change without notice. Customers should verify actual device performance in their specific applications.

# 2036 Series - Miniature 3-Pole Gas Discharge Tube

**BOURNS®**

## Switch-Grade Fail-Short Device Shorting Curve 2036-XX-XF

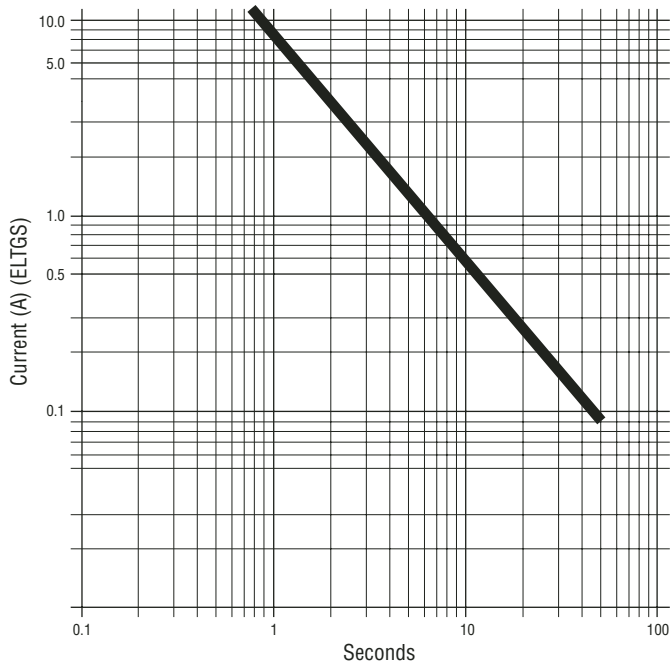

ELTGS = Each Line to Ground Simultaneously

NOTE: When using a GDT failsafe device, it is imperative that all components associated and connected to the GDT with failsafe be tested in their respective completely integrated environment (finished product) to assure proper operation.

## How To Order

**2036 - xx - x - nn - F LF**

Model Number \_\_\_\_\_  
 Designator \_\_\_\_\_

Voltage (Divided by 10) \_\_\_\_\_  
 07 = 75 V      30 = 300 V  
 09 = 90 V      35 = 350 V  
 15 = 150 V     40 = 400 V  
 20 = 200 V     42 = 420 V  
 23 = 230 V     47 = 470 V  
 25 = 250 V     60 = 600 V

Leads \_\_\_\_\_  
 A = None  
 B = 0.8 mm  
 C = 1 mm

Lead Shape \_\_\_\_\_  
 (See Product Dimension Drawings)

Fail-Short Option \_\_\_\_\_  
 Blank = Standard Product  
 F = With Fail-Short Mechanism

Lead Free Option \_\_\_\_\_  
 Blank = Standard Product  
 LF = Lead Free/RoHS Compliant Product

## Packaging Specifications

Model 2036-xx-nn ships standard bulk pack, 100 pcs./tray.