



Features

- Balanced Mini-TRIGARD™
- 5 mm diameter, 7.5 mm long
- UL Recognized ®
- RoHS compliant* versions available

Applications

- Telecommunications
- Industrial electronics
- Commercial electronics
- Consumer electronics
- Automotive, aircraft, military electronics

2036 Series - Miniature 3-Pole Gas Discharge Tube

Characteristics

Test Methods per ITU-T (CCITT) K.12, IEEE C62.31

Characteristic	Model No.					
	2036-07	2036-09	2036-15	2036-20	2036-23	2036-25
DC Sparkover $\pm 20\%$ @ 100 V/s	75 V	90 V	150 V	200 V	230 V	250V
Impulse Sparkover	250 V	250 V	350 V	425 V	450 V	475 V
1000 V/ μ s	525 V	550 V	500 V	575 V	600 V	625 V

Characteristic	Model No.					
	2036-30	2036-35	2036-40	2036-42	2036-47	2036-60
DC Sparkover $\pm 20\%$ @ 100 V/s	300 V	350 V	400 V	420 V	470 V	600 V
Impulse Sparkover	500 V	600 V	650 V	675 V	750 V	850 V
1000 V/ μ s	650 V	750 V	825 V	850 V	950 V	1100 V

Impulse Transverse Delay.....100 V/ μ s	< 75 ns	
Insulation Resistance100 V (50 V for Model 2036-07 & 2036-09)	> $10^{10} \Omega$	
Glow Voltage10 mA	~ 70 V	
Arc Voltage1 A	~ 10 V	
Glow-Arc Transition Current.....	< 0.5 A	
Capacitance1 MHz	< 2 pF	
DC Holdover Voltage ¹135 V, (52 V for Model 2036-07 & 2036-09,	< 150 ms	
	80 V for Model 2036-15)	
Impulse Discharge Current.....20000 A, 8/20 μ s ²	1 operation minimum	
	10000 A, 8/20 μ s	> 10 operations
	2000 A, 10/350 μ s	1 operation
	200 A, 10/1000 μ s	> 300 operations
	200 A, 10/700 μ s	> 500 operations
Alternating Discharge Current20 Arms, 1 s ²	1 operation minimum	
	10 Arms, 1 s	> 10 operations
Operating Temperature.....	-55 to +85 °C	
Climatic Category (IEC 60068-1).....	40/90/21	

Optional Switch-Grade Fail-Short device available.

Notes:

- **UL recognized component, UL File E153537.**
- No model number marking on tube; date code and voltage only: month year digits, xxxV (e.g. 0209 400V).
- The rated discharge current for Mini-TRIGARD™ Gas Discharge Tubes is the total current equally divided between each line to ground.
- Sparkover limits after life $\pm 25\%$, IR $> 10^9 \Omega$ (-25 %, +30 % for Model 2036-07, 2036-09 and 2036-60).
- Operating characteristics per RUS PE-80 and Telcordia GR 1361 available, contact factory.
- Line to Line voltage is approximately 1.8 to 2 times the stated Line to Ground breakdown voltage.
- At delivery AQL 0.65 Level II, DIN ISO 2859.

¹ Network applied.

² DC Sparkover may exceed $\pm 25\%$ after discharge, but will continue to protect without venting.

*RoHS Directive 2002/95/EC Jan 27, 2003 including Annex.

Specifications are subject to change without notice.

Customers should verify actual device performance in their specific applications.

2036 Series - Miniature 3-Pole Gas Discharge Tube

BOURNS®

Product Dimensions

2036-XX-A

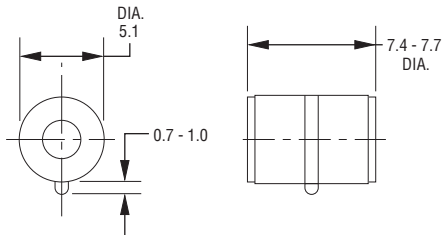

2036-XX-B2 — 0.8 mm dia. lead wire
2036-XX-C2 — 1.0 mm dia. lead wire*

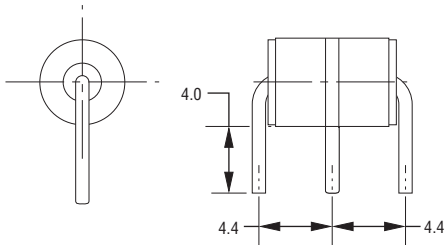

2036-XX-B3 — 0.8 mm dia. lead wire
2036-XX-C3 — 1.0 mm dia. lead wire*

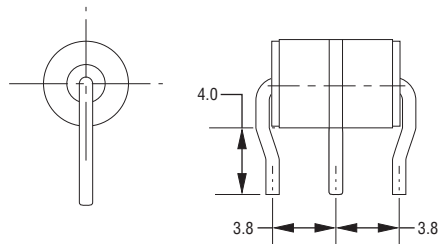

2036-XX-B9 — 0.8 mm dia. lead wire
2036-XX-C9 — 1.0 mm dia. lead wire*

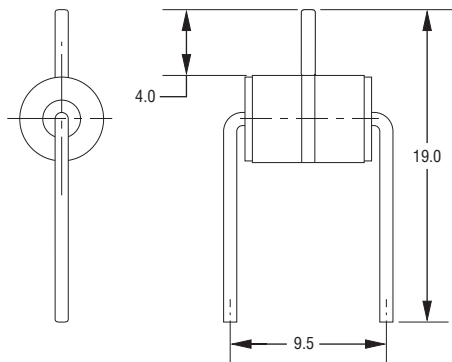

DIMENSIONS = MILLIMETERS

2036-XX-B — 0.8 mm dia. lead wire 2036-XX-C — 1.0 mm dia. lead wire*

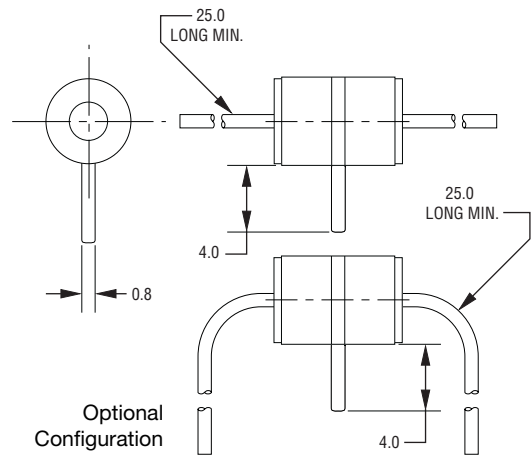

2036-XX-B8 — 0.8 mm dia. lead wire
2036-XX-C8 — 1.0 mm dia. lead wire*

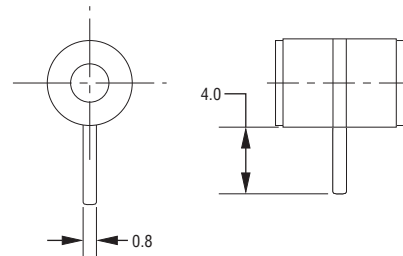

FAIL-SHORT CONFIGURATION 2036-XX-B2F SHOWN

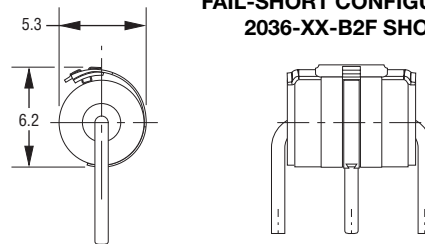

CENTER ELECTRODE LEAD: C-CONFIGURATION

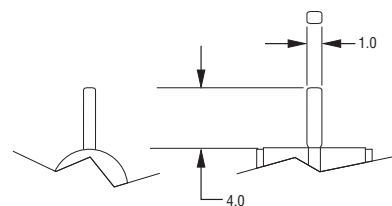

*Center Electrode Lead: See Center Lead C-Configuration detail.
 Specifications are subject to change without notice.
 Customers should verify actual device performance in their specific applications.

2036 Series - Miniature 3-Pole Gas Discharge Tube

BOURNS®

Switch-Grade Fail-Short Device Shorting Curve 2036-XX-XF

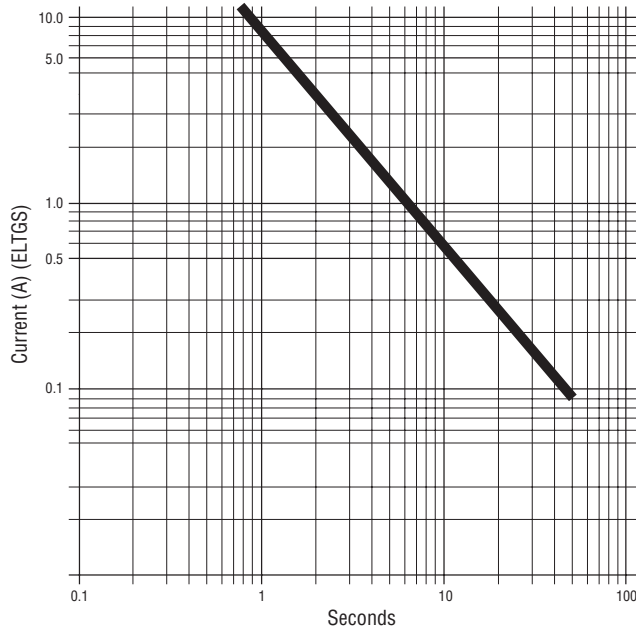

ELTGS = Each Line to Ground Simultaneously

NOTE: When using a GDT failsafe device, it is imperative that all components associated and connected to the GDT with failsafe be tested in their respective completely integrated environment (finished product) to assure proper operation.

How to Order

2036 - xx - x - nn - F LF

Model Number Designator _____

Voltage (Divided by 10) _____

07 = 75 V	30 = 300 V
09 = 90 V	35 = 350 V
15 = 150 V	40 = 400 V
20 = 200 V	42 = 420 V
23 = 230 V	47 = 470 V
25 = 250 V	60 = 600 V

Leads _____

- A = None
- B = 0.8 mm
- C = 1 mm

Lead Shape _____

(See Product Dimension Drawings)

Fail-Short Option _____

- Blank = Standard Product
- F = With Fail-Short Mechanism

Lead Free Option _____

- Blank = Standard Product
- LF = Lead Free/RoHS Compliant Product

Packaging Specifications

Model 2036-xx-nn ships standard bulk pack, 100 pcs./tray.

REV. 01/11

Specifications are subject to change without notice.
Customers should verify actual device performance in their specific applications.