

RoHS  **239 Series, 5 x 20 mm, Slo-Blo® Fuse**



Description

5x20mm time-Lag glass body cartridge fuse designed to UL specification.





Features

- Designed to UL/CSA/ ANCE 248 Standard
- Available in cartridge and axial lead format
- RoHS compliant and lead-free

Applications

Used as supplementary protection in appliance or utilization equipment to provide individual protection for components or internal circuits.

Agency Approvals

Agency	Agency File Number	Ampere Range
	Cartridge Certificates: NBK290502-E10480 G NBK280602-E10480 C NBK290502-E10480 I	1A – 3.5A 4A & 5A 7A
	Leaded Certificates: NBK290502-E10480 H NBK280602-E10480 D NBK290502-E10480 J	1A – 3.15A 4A & 5A 7A
	Certificates: SU05001 – 2004A SU05001 – 2014A	200mA – 3.15A 4A – 7A
	Listed File: E10480 Guide: JDYX	80mA – 7A
	File: 029862 Certificates Class: LR1422-01	200mA – 3.15A 4A – 7A
		80mA – 7A

Electrical Characteristics for Series

% of Ampere Rating	Ampere Ratings	Opening Time
100%	All Ratings	4 hours, Minimum
135%		1 hour, Maximum
200%		5 seconds., Min; 2 min., Max

Electrical Characteristic Specification by Item

Amp Code	Amp Rating (A)	Voltage Rating (V)	Interrupting Rating	Nominal Cold Resistance (Ohms)	Nominal Melting I ² t (A ² sec)	Agency Approvals				
						UL	SF	PSE	CCC	CE
.080	0.08	250	35A @ 125 VAC	28.1750	0.02500	x				x
.100	0.1	250		17.3425	0.05500	x				x
.125	0.125	250		11.6000	0.08500	x				x
.150	0.15	250	35A @ 125 VAC 10000A @ 125 VAC	8.1000	0.13000	x				x
.200	0.2	250		3.8725	0.16500	x	x		x	x
.250	0.25	250		3.0700	0.34000	x	x		x	x
.300	0.3	250		2.3000	0.61500	x	x		x	x
.400	0.4	250		1.4750	1.49000	x	x		x	x
.500	0.5	250		0.9090	1.98500	x	x		x	x
.600	0.6	250		0.6990	2.41500	x	x		x	x
.700	0.7	250		0.5375	4.12000	x	x		x	x
.750	0.75	250		0.4710	5.42500	x	x		x	x
.800	0.8	250		0.4155	7.56500	x	x		x	x
001.	1	250		0.2965	11.29500	x	x	x	x	x
1.25	1.25	250		0.1980	19.52500	x	x	x	x	x
01.6	1.6	250	0.1205	30.43000	x	x	x	x	x	
002.	2	250	0.0943	50.58500	x	x	x	x	x	
02.5	2.5	250	0.0583	79.70500	x	x	x	x	x	
003.	3	250	0.04877	129.51000	x	x	x	x	x	
3.15	3.15	250	0.0414	128.05000	x	x	x	x	x	
03.2	3.2	250	0.0385	128.05000	x		x		x	
03.5	3.5	250	0.0370	128.05000	x		x		x	
004.	4	125	10000A @ 125 VAC 100A @ 250 VAC	0.0312	270.703	x	x	x	x	x
005.	5	125		0.0199	302.836	x	x	x	x	x
007.	7	125		0.0114	305.758	x	x	x	x	x

Temperature Derating Curve

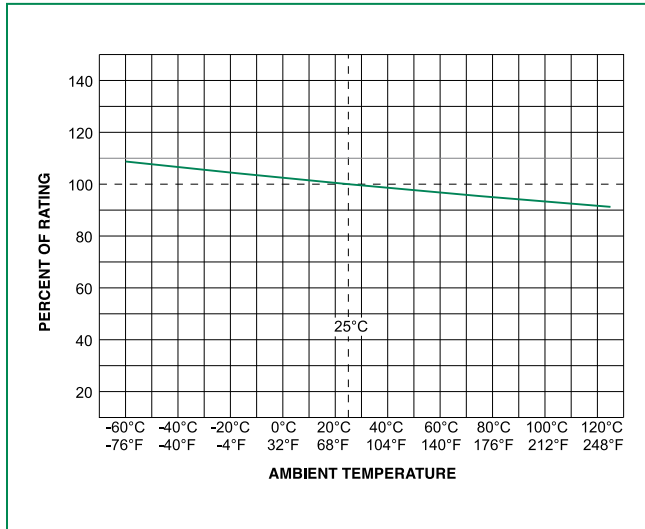

Average Time Current Curves

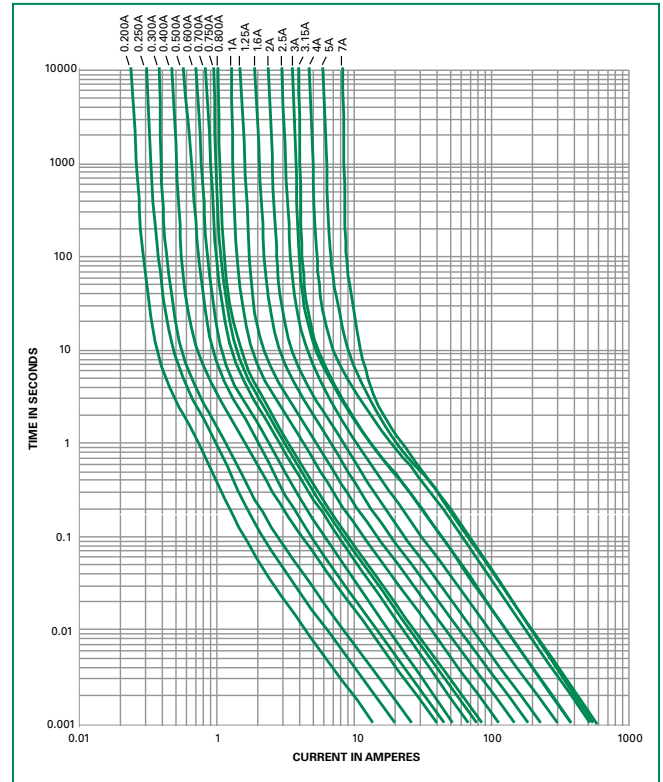

Soldering Parameters - Wave Soldering

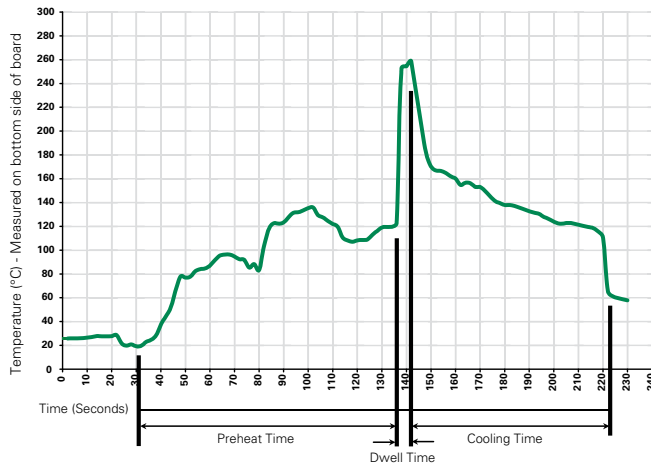

Recommended Process Parameters:

Wave Parameter	Lead-Free Recommendation
Preheat: (Depends on Flux Activation Temperature) (Typical Industry Recommendation)	
Temperature Minimum:	100° C
Temperature Maximum:	150° C
Preheat Time:	60-180 seconds
Solder Pot Temperature:	260° C Maximum
Solder Dwell Time:	2-5 seconds

Recommended Hand-Solder Parameters:

Solder Iron Temperature: 350° C +/- 5° C
Heating Time: 5 seconds max.

Note: These devices are not recommended for IR or Convection Reflow process.

Product Characteristics

Materials	Body: Glass Cap: Nickel-plated brass Leads: Tin-plated Copper
Terminal Strength	MIL-STD-202G, Method 211A, Test Condition A
Solderability	Reference IEC 60127 Second Edition 2003-01 Annex A
Product Marking	Cap 1: Brand logo, current and voltage rating Cap 2: Series and agency approval markings

Operating Temperature	-55°C to +125°C
Thermal Shock	MIL-STD-202G, Method 107G, Test Condition B: (5 cycles -65°C to +125°C)
Vibration	MIL-STD-202G, Method 201A
Humidity	MIL-STD-202G, Method 103B, Test Condition A. high RH (95%) and elevated temp (40°C) for 240 hours
Salt Spray	MIL-STD-202G, Method 101D, Test Condition B

Dimensions

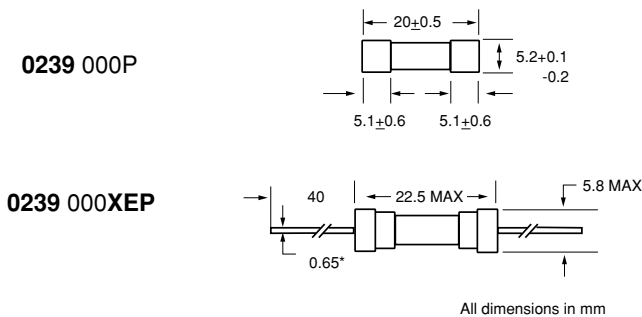

Notes:
* Ratings above 6.3A
have 0.8 mm dia lead

Part Numbering System

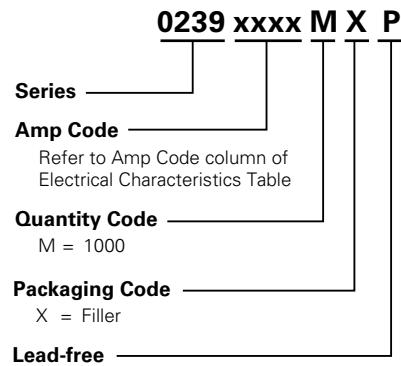

Packaging

Packaging Option	Packaging Specification	Quantity	Quantity & Packaging Code	Taping Width
239 Series				
Bulk	N/A	1000	MXE	N/A
Bulk	N/A	1000	MXB	N/A
Reel and Tape	EIA 296-E	1000	MRET1	T1=52mm (2.062)