

## R-Rated Fuses For Motor Circuit Protection Medium Voltage

## JCK, JCK-A, JCK-B, JCH, JCL, JCL-A, JCL-B, JCG, JCR-A, & JCR-B



- R-Rated medium voltage fuses are back-up current limiting fuses used in conjunction with medium voltage motors and motor controllers.
- The JCK-A, JCL-A, & JCR-A are supplied with Cutler-Hammer Ampgard Hookeye.
- This single hookeye is on one end of the fuse and aids in the insertion and removal of the fuse.
- Current limiting fuses may be designated as R-Rated if they meet the following requirements:
  1. The fuse will safely interrupt all currents between its minimum and maximum interrupting ratings.
  2. The fuse will melt in a range of 15 to 35 seconds at a value of 100 times the "R" number (ANSI C37.46).
- Bussmann R-Rated current limiting fuses are designed for use with medium voltage starters to provide short-circuit protection for the motor and motor controller.
- These fuses offer a high level of fault current interruption in a self-contained, non-venting package which can be mounted indoors or in an enclosure.
- Open fuse indication on all fuses.

**Catalog Symbol:** JCK, JCK-A, JCK-B, JCH, JCL, JCL-A, JCL-B, JCG, JCR-A, & JCR-B

### R-Rated Medium Voltage Current Limiting

2400V AC — JCK, JCK-A, JCK-B, JCH

4800V AC — JCL, JCL-A, JCL-B, JCG

7200V AC — JCR-A, JCR-B

**Max. Design Voltage** 2540V AC — JCK, JCK-A, JCK-B, JCH  
5080V AC — JCL, JCL-A, JCL-B, JCG  
8300V AC — JCR-A, JCR-B

**UL Recognized:** 2540V AC — JCK, JCK-A  
5080V AC — JCL, JCL-A  
(2R-24R)

UL Recognized (GUIDE #MSSS2, FILE # E96676)

# R-Rated Fuses

## For Motor Circuit Protection

### Medium Voltage

# JCK, JCK-A, JCK-B, JCH, JCL, JCL-A, JCL-B, JCG, JCR-A, & JCR-B

#### Specifications

Buss Catalog No.	Amperage	Maximum Design Voltage	Dimensions (Inches)			Construction	Max. Int. Cap.		Min. Int. Cap.
			A	B	C		Amps (Asym.)	Amps (Sym.)	Amps (Sym.)
<b>2400V; R-Rated; Indoor/Enclosure (See Figure 1)</b>									
JCK-2R	70 2R	2540V	11.24	3.0	3.0	Single	80,000	50,000	165
JCK-3R	100 3R	2540V	11.24	3.0	3.0	Single	80,000	50,000	220
JCK-4R	130 4R	2540V	11.24	3.0	3.0	Single	80,000	50,000	320
JCK-5R	150 5R	2540V	11.24	3.0	3.0	Single	80,000	50,000	410
JCK-6R	170 6R	2540V	11.24	3.0	3.0	Single	80,000	50,000	480
JCK-9R	200 9R	2540V	11.24	3.0	3.0	Single	80,000	50,000	720
JCK-12R	230 12R	2540V	11.24	3.0	3.0	Single	80,000	50,000	970
JCK-18R	390 18R	2540V	11.24	3.0	3.0	Double	80,000	50,000	1,430
JCK-24R	450 24R	2540V	11.24	3.0	3.0	Double	80,000	50,000	1,880
<b>2400V; R-Rated; Indoor/Enclosure; With Cutler-Hammer Ampgard Hookeye (See Figure 1)</b>									
JCK-A-2R	70 2R	2540V	11.24	3.0	3.0	Single	80,000	50,000	165
JCK-A-3R	100 3R	2540V	11.24	3.0	3.0	Single	80,000	50,000	220
JCK-A-4R	130 4R	2540V	11.24	3.0	3.0	Single	80,000	50,000	320
JCK-A-5R	150 5R	27540V	11.24	3.0	3.0	Single	80,000	50,000	410
JCK-A-6R	170 6R	2540V	11.24	3.0	3.0	Single	80,000	50,000	480
JCK-A-9R	200 9R	2540V	11.24	3.0	3.0	Single	80,000	50,000	720
JCK-A-12R	230 12R	2540V	11.24	3.0	3.0	Single	80,000	50,000	970
JCK-A-18R	390 18R	2540V	11.24	3.0	3.0	Double	80,000	50,000	1,430
JCK-A-24R	450 24R	2540V	11.24	3.0	3.0	Double	80,000	50,000	1,880
<b>2400V; R-Rated; Indoor/Enclosure; Bolt-On (See Figure 2)</b>									
JCK-B-30	25	2540V	14.18	12.81	-	Single	80,000	50,000	100
JCK-B-2R	70 2R	2540V	14.18	12.81	-	Single	80,000	50,000	180
JCK-B-3R	100 3R	2540V	14.18	12.81	-	Single	80,000	50,000	270
JCK-B-4R	130 4R	2540V	14.18	12.81	-	Single	80,000	50,000	360
JCK-B-5R	150 5R	2540V	14.18	12.81	-	Single	80,000	50,000	450
JCK-B-6R	170 6R	2540V	14.18	12.81	-	Single	80,000	50,000	540
JCK-B-9R	200 9R	2540V	14.18	12.81	-	Single	80,000	50,000	740
JCK-B-12R	230 12R	2540V	14.18	12.81	-	Single	80,000	50,000	1,080
JCK-B-18R	390 18R	2540V	14.18	12.81	3.56	Double	80,000	50,000	1,500
JCK-B-24R	450 24R	2540V	14.18	12.81	3.56	Double	80,000	50,000	2,200
<b>2400V; R-Rated; Indoor; Hermetically Sealed, Class 1, Group D, Div. 2, Hazardous Locations; For Use with Ampgard Motor Starters (See Figure 1)</b>									
JCH-30	25	2540V	11.56	3.0	4.12	Single	80,000	50,000	100
JCH-2R	70 2R	2540V	11.56	3.0	4.12	Single	80,000	50,000	180
JCH-3R	100 3R	2540V	11.56	3.0	4.12	Single	80,000	50,000	270
JCH-4R	130 4R	2540V	11.56	3.0	4.12	Single	80,000	50,000	360
JCH-5R	150 5R	2540V	11.56	3.0	4.12	Single	80,000	50,000	450
JCH-6R	170 6R	2540V	11.56	3.0	4.12	Single	80,000	50,000	540
JCH-9R	200 9R	2540V	11.56	3.0	4.12	Single	80,000	50,000	740
JCH-12R	230 12R	2540V	11.56	3.0	4.12	Single	80,000	50,000	1,080
JCH-18R	390 18R	2540V	11.56	3.0	7.68	Double	80,000	50,000	1,500
JCH-24R	450 24R	2540V	11.56	3.0	7.68	Double	80,000	50,000	2,200
<b>4800V; R-Rated; Indoor/Enclosure (See Figure 1)</b>									
JCL-2R	70 2R	5080V	15.76	3.0	3.0	Single	80,000	50,000	165
JCL-3R	100 3R	5080V	15.76	3.0	3.0	Single	80,000	50,000	220
JCL-4R	130 4R	5080V	15.76	3.0	3.0	Single	80,000	50,000	320
JCL-5R	150 5R	5080V	15.76	3.0	3.0	Single	80,000	50,000	410
JCL-6R	170 6R	5080V	15.76	3.0	3.0	Single	80,000	50,000	480
JCL-9R	200 9R	5080V	15.76	3.0	3.0	Single	80,000	50,000	720
JCL-12R	230 12R	5080V	15.76	3.0	3.0	Single	80,000	50,000	970
JCL-18R	390 18R	5080V	15.76	3.0	3.0	Double	80,000	50,000	1,430
JCL-24R	450 24R	5080V	15.76	3.0	3.0	Double	80,000	50,000	1,880

# R-Rated Fuses

## For Motor Circuit Protection

### Medium Voltage

# JCK, JCK-A, JCK-B, JCH, JCL, JCL-A, JCL-B, JCG, JCR-A, & JCR-B

#### Specifications

Buss Catalog No.	Amperage	Maximum Design Voltage	Dimensions (Inches)			Construction	Max. Int. Cap.		Min. Int. Cap.
			A	B	C		Amps (Asym.)	Amps (Sym.)	Amps (Sym.)
<b>4800V; R-Rated; Indoor/Enclosure; With Cutler-Hammer Ampgard Hookeye (See Figure 1)</b>									
JCL-A-2R	70 2R	5080V	15.76	3.0	3.0	Single	80,000	50,000	165
JCL-A-3R	100 3R	5080V	15.76	3.0	3.0	Single	80,000	50,000	220
JCL-A-4R	130 4R	5080V	15.76	3.0	3.0	Single	80,000	50,000	320
JCL-A-5R	150 5R	5080V	15.76	3.0	3.0	Single	80,000	50,000	410
JCL-A-6R	170 6R	5080V	15.76	3.0	3.0	Single	80,000	50,000	480
JCL-A-9R	200 9R	5080V	15.76	3.0	3.0	Single	80,000	50,000	720
JCL-A-12R	230 12R	5080V	15.76	3.0	3.0	Single	80,000	50,000	970
JCL-A-18R	390 18R	5080V	15.76	3.0	3.0	Double	80,000	50,000	1,430
JCL-A-24R	450 24R	5080V	15.76	3.0	3.0	Double	80,000	50,000	1,880
JCL-A-36R	650 36R	5080V	16.0	4.0	-	Double	100,000	63,000	3,200
<b>4800V; R-Rated; Indoor/Enclosure; Bolt-On (See Figure 2)</b>									
JCL-B-30	30	5080V	19.25	17.88	-	Single	80,000	50,000	100
JCL-B-2R	70 2R	5080V	19.25	17.88	-	Single	80,000	50,000	180
JCL-B-3R	100 3R	5080V	19.25	17.88	-	Single	80,000	50,000	270
JCL-B-4R	130 4R	5080V	19.25	17.88	-	Single	80,000	50,000	360
JCL-B-5R	150 5R	5080V	19.25	17.88	-	Single	80,000	50,000	450
JCL-B-6R	170 6R	5080V	19.25	17.88	-	Single	80,000	50,000	540
JCL-B-9R	200 9R	5080V	19.25	17.88	-	Single	80,000	50,000	740
JCL-B-12R	230 12R	5080V	19.25	17.88	-	Single	80,000	50,000	1,080
JCL-B-18R	390 18R	5080V	19.25	17.88	3.31	Double	80,000	50,000	1,500
JCL-B-24R	450 24R	5080V	19.25	17.88	3.31	Double	80,000	50,000	2,200
<b>4800V; R-Rated; Indoor; Hermetically Sealed, Class 1, Group D, Div. 2, Hazardous Locations; For Use with Ampgard Motor Starters (See Figure 1)</b>									
JCG-30	30	5080V	16.6	3.0	4.12	Single	80,000	50,000	95
JCG-2R	70 2R	5080V	16.6	3.0	4.12	Single	80,000	50,000	180
JCG-3R	100 3R	5080V	16.6	3.0	4.12	Single	80,000	50,000	270
JCG-4R	130 4R	5080V	16.6	3.0	4.12	Single	80,000	50,000	350
JCG-5R	150 5R	5080V	16.6	3.0	4.12	Single	80,000	50,000	450
JCG-6R	170 6R	5080V	16.6	3.0	4.12	Single	80,000	50,000	540
JCG-9R	200 9R	5080V	16.6	3.0	4.12	Single	80,000	50,000	700
JCG-12R	230 12R	5080V	16.6	3.0	4.12	Single	80,000	50,000	1,000
JCG-18R	390 18R	5080V	15.85	3.0	6.31	Double	80,000	50,000	1,450
JCG-24R	450 24R	5080V	15.85	3.0	6.31	Double	80,000	50,000	2,000
<b>7200V; R-Rated; Indoor/Enclosure; With Ampgard Hookeye (See Figure 1)</b>									
JCR-A-2R	70 2R	8300V	15.85	3.0	4.12	Single	80,000	50,000	200
JCR-A-3R	100 3R	8300V	15.85	3.0	4.12	Single	80,000	50,000	320
JCR-A-4R	130 4R	8300V	15.85	3.0	4.12	Single	80,000	50,000	405
JCR-A-5R	150 5R	8300V	15.85	3.0	4.12	Single	80,000	50,000	550
JCR-A-6R	170 6R	8300V	15.85	3.0	4.12	Single	80,000	50,000	670
JCR-A-9R	200 9R	7200V	15.85	3.0	4.12	Single	80,000	50,000	1,300
JCR-A-12R	230 12R	7200V	15.85	3.0	4.12	Single	80,000	50,000	1,500
JCR-A-18R	390 18R	7200V	15.85	3.0	7.43	Double	80,000	50,000	2,000
JCR-A-24R	450 24R	7200V	15.85	3.0	7.43	Double	80,000	50,000	2,600
<b>7200V; R-Rated; Indoor/Enclosure; Bolt-On (See Figure 2)</b>									
JCR-B-2R	70 2R	8300V	19.25	17.88	-	Single	80,000	50,000	200
JCR-B-3R	100 3R	8300V	19.25	17.88	-	Single	80,000	50,000	320
JCR-B-4R	130 4R	8300V	19.25	17.88	-	Single	80,000	50,000	405
JCR-B-5R	150 5R	8300V	19.25	17.88	-	Single	80,000	50,000	550
JCR-B-6R	170 6R	8300V	19.25	17.88	-	Single	80,000	50,000	670
JCR-B-9R	200 9R	7200V	19.25	17.88	-	Single	80,000	50,000	1,300
JCR-B-12R	230 12R	7200V	19.25	17.88	-	Single	80,000	50,000	1,500
JCR-B-18R	390 18R	7200V	19.25	17.88	3.31	Double	80,000	50,000	2,000
JCR-B-24R	450 24R	7200V	19.25	17.88	3.31	Double	80,000	50,000	2,600

# R-Rated Fuses

## For Motor Circuit Protection

### Medium Voltage

# JCK, JCK-A, JCK-B, JCH, JCL, JCL-A, JCL-B, JCG, JCR-A, & JCR-B

#### Dimensional Data

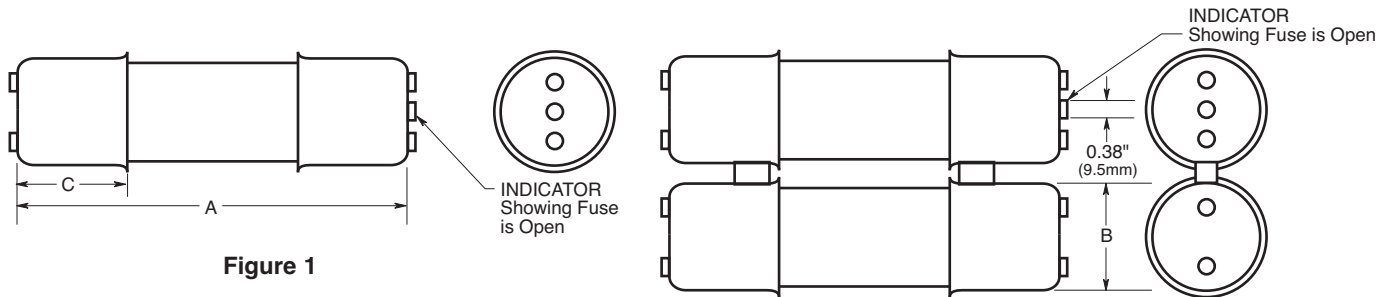
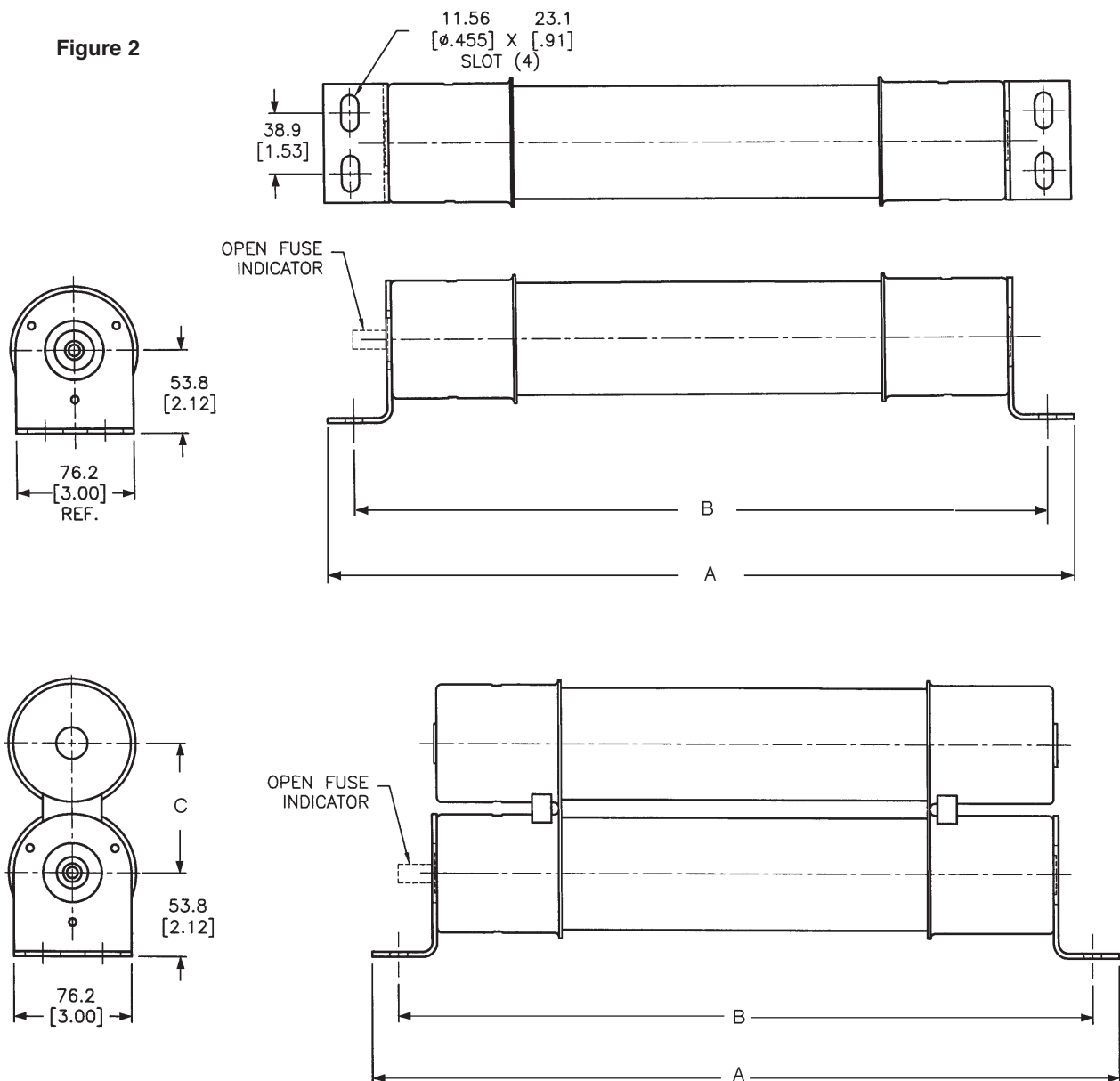

Figure 1

Figure 2



# R-Rated Fuses For Motor Circuit Protection Medium Voltage

# JCK, JCK-A, JCK-B, JCH, JCL, JCL-A, JCL-B, JCG, JCR-A, & JCR-B

## JCK, JCK-A, JCL, JCL-A

Time-Current Characteristic Curves—Minimum Melt

167-A

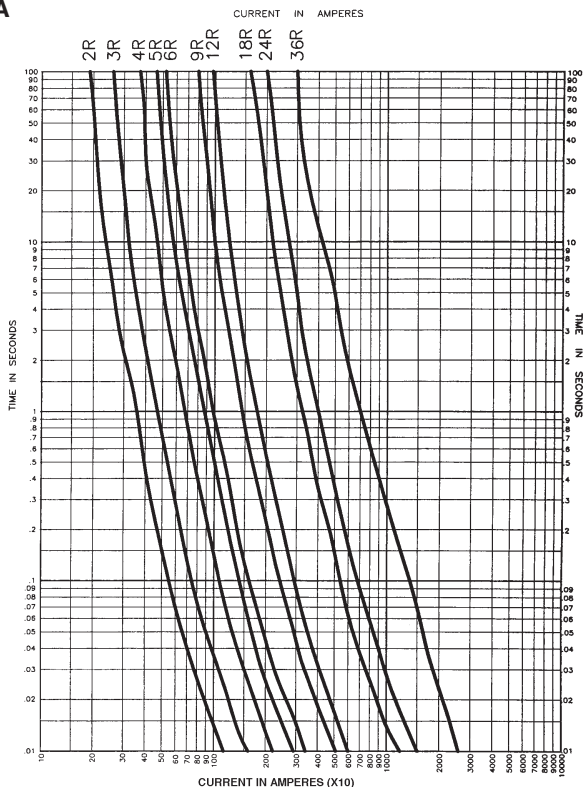

Total Clearing Curves

168-A

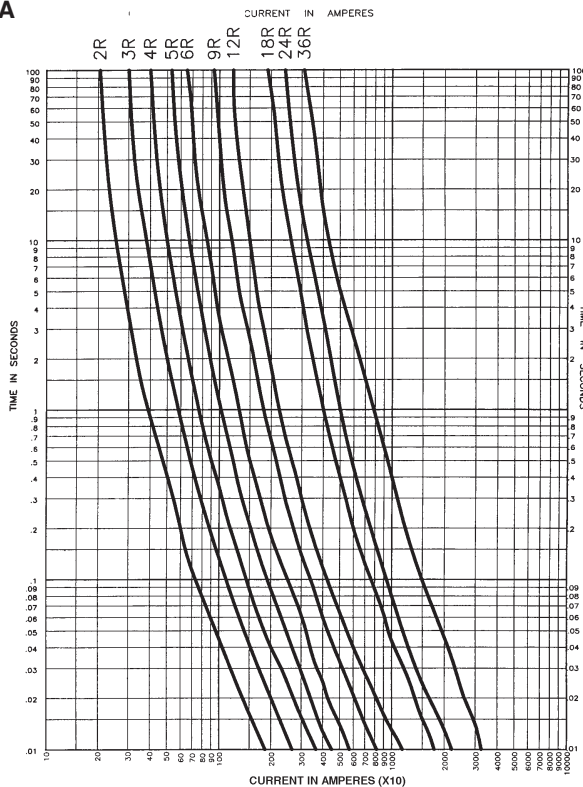

Current Limitation Curves

184-A

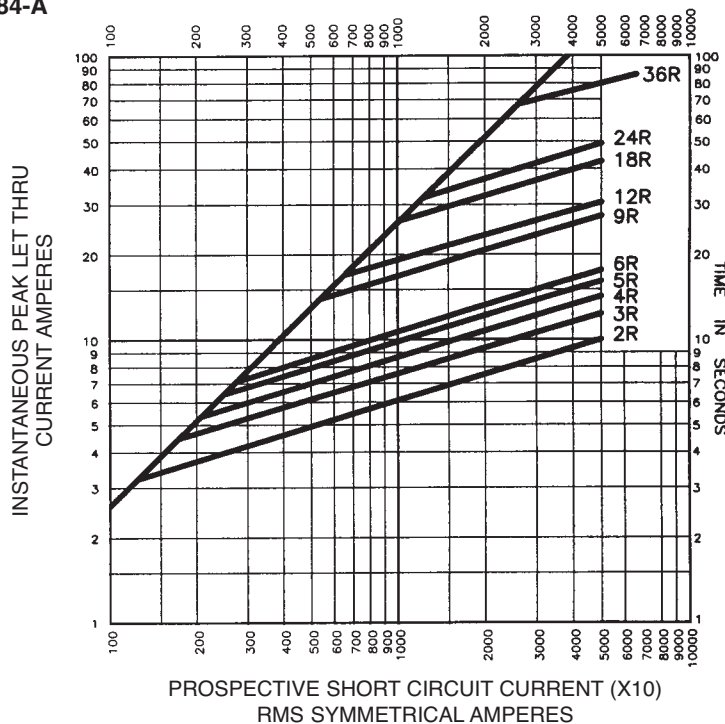

# R-Rated Fuses For Motor Circuit Protection Medium Voltage

# JCK, JCK-A, JCK-B, JCH, JCL, JCL-A, JCL-B, JCG, JCR-A, & JCR-B

## JCK-B, JCH

Time-Current Curve: Minimum Melt

50999-1

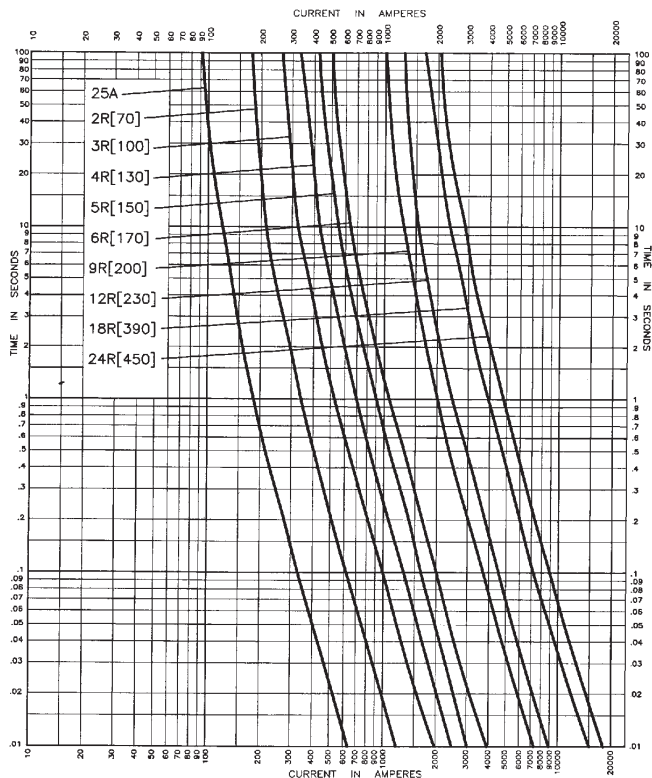

Time-Current Curve: Total Clearing

50999-2

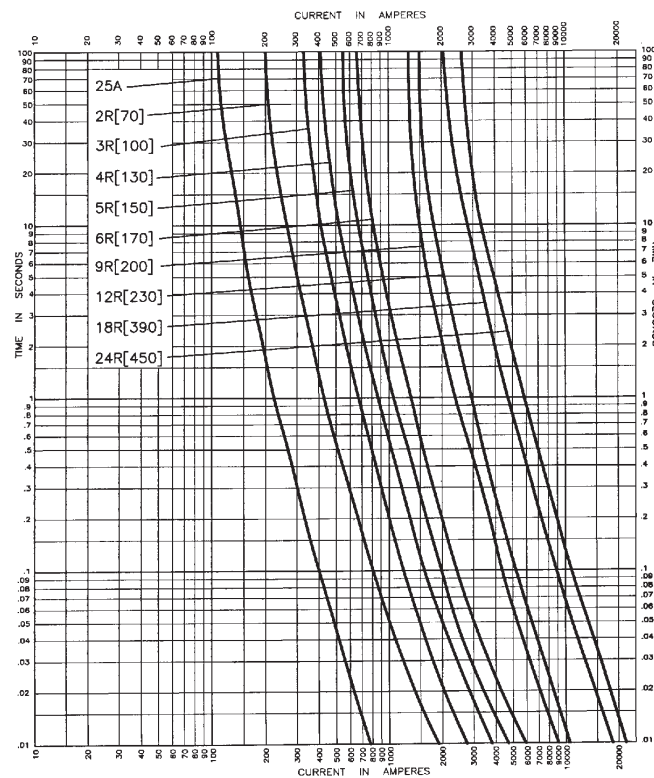

## Peak Let-Through Curves

50999-3

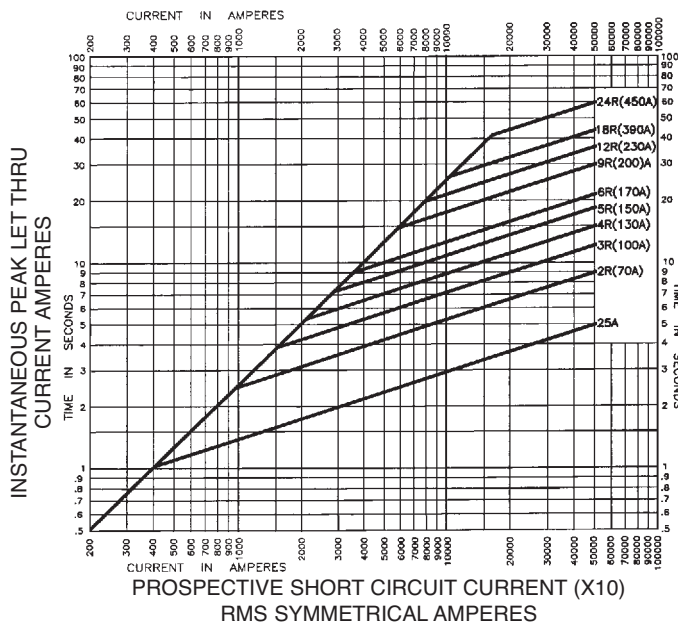

# R-Rated Fuses For Motor Circuit Protection Medium Voltage

# JCK, JCK-A, JCK-B, JCH, JCL, JCL-A, JCL-B, JCG, JCR-A, & JCR-B

## JCL-B, JCG

Time-Current Curve: Minimum Melt

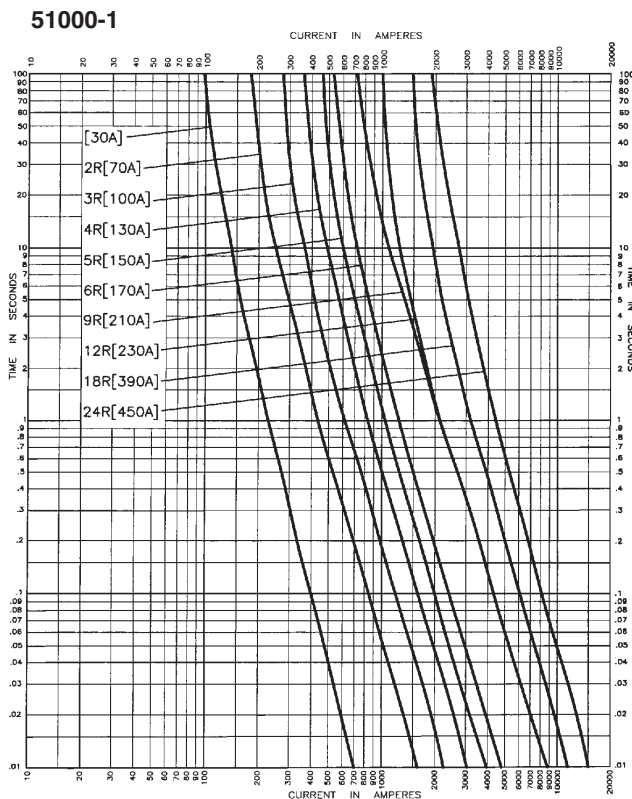

Time-Current Curve: Total Clearing

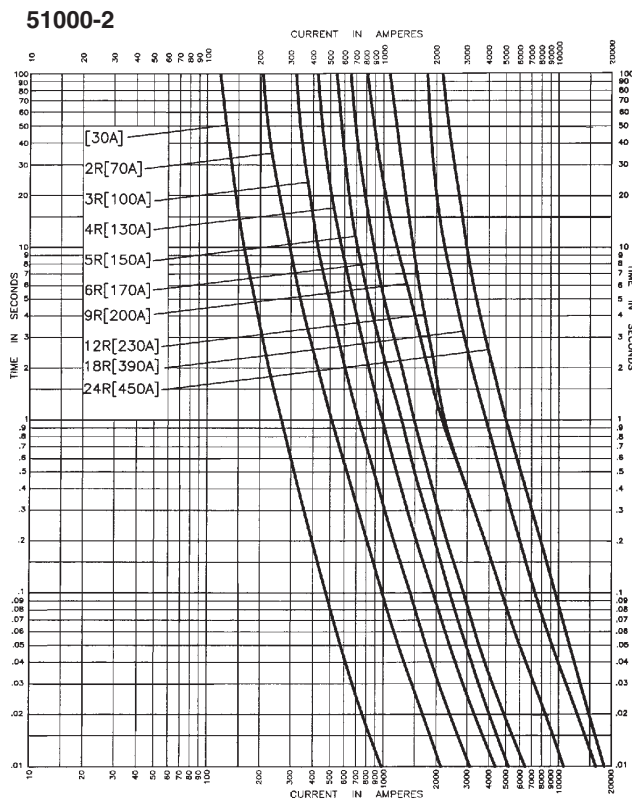

### Peak Let-Through Curves

51000-3

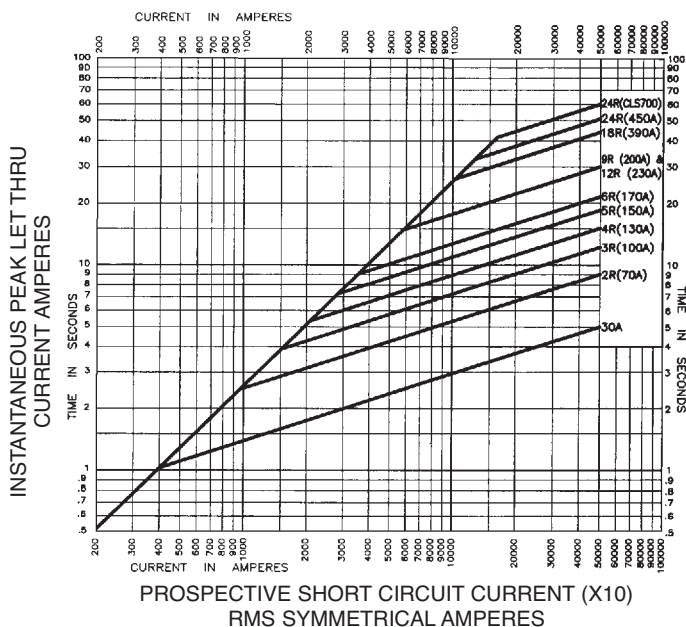

# R-Rated Fuses For Motor Circuit Protection Medium Voltage

# JCK, JCK-A, JCK-B, JCH, JCL, JCL-A, JCL-B, JCG, JCR-A, & JCR-B

## JCR, JCR-B

Time-Current Curve: Minimum Melt

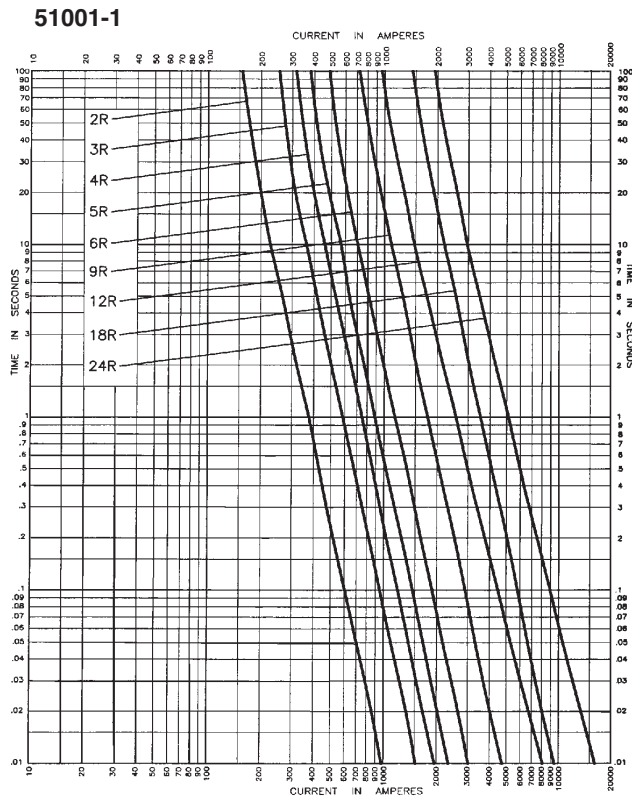

Time-Current Curve: Total Clearing

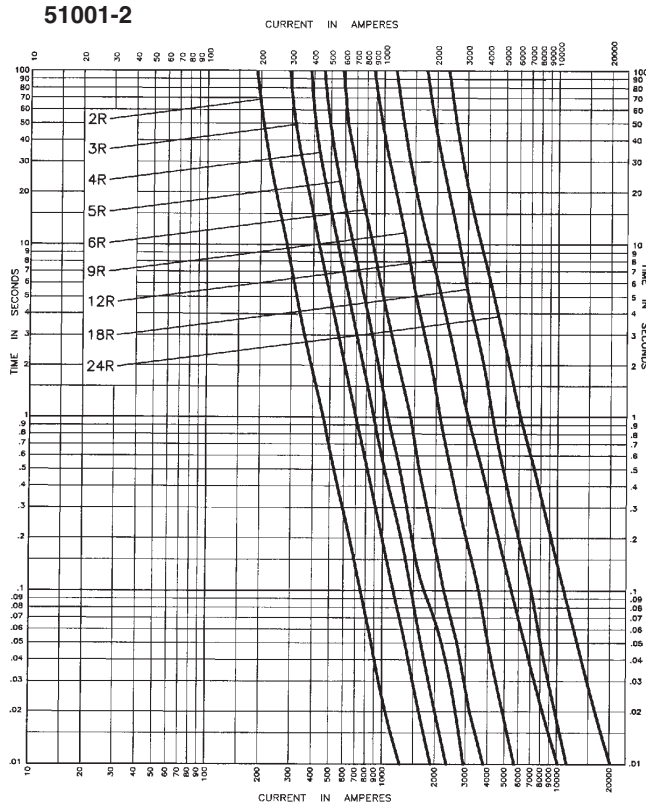

## Peak Let-Through Curves

51001-3

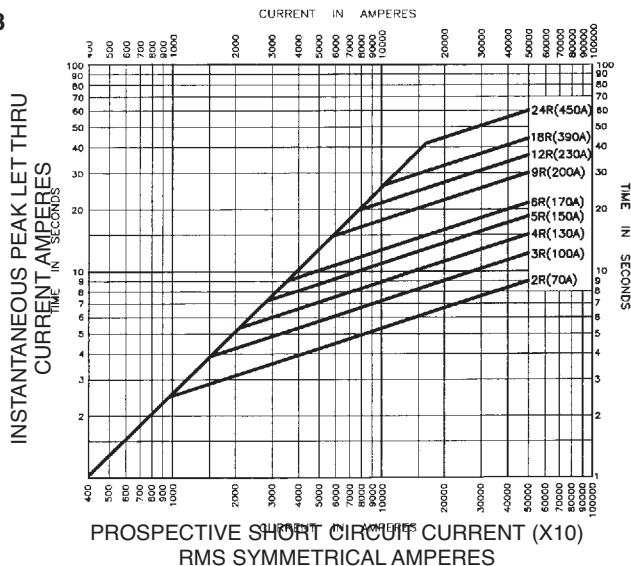

The only controlled copy of this Data Sheet is the electronic read-only version located on the Bussmann Network Drive. All other copies of this Data Sheet are by definition uncontrolled. This bulletin is intended to clearly present comprehensive product data and provide technical information that will help the end user with design applications. Bussmann reserves the right, without notice, to change design or construction of any products and to discontinue or limit distribution of any products. Bussmann also reserves the right to change or update, without notice, any technical information contained in this bulletin. Once a product has been selected, it should be tested by the user in all possible applications.