

NH Low Voltage Industrial Fuse links		Voltage	Page
Size: C00 (000)	Class: gG/gL	500Vac	1-2
Size: 00	Class: gG/gL	500Vac	3-4
Size: 1	Class: gG/gL	500Vac	5-6
Size: 2	Class: gG/gL	500Vac	7-8
Size: 3	Class: gG/gL	500Vac	9-10
Size: 4a	Class: gG/gL	500Vac	11-12
Size: 00	Class: gG/gL	690Vac	13-14
Size: 1	Class: gG/gL	690Vac	15-16
Size: 2	Class: gG/gL	690Vac	17-18
Size: 3	Class: gG/gL	690Vac	19-20
Size: C00 (000)	Class: aM	500Vac	21-22
Size: 00	Class: aM	500Vac	23-24
Size: 1	Class: aM	500Vac	25-26
Size: 2	Class: aM	500Vac	27-28
Size: 3	Class: aM	500Vac	29-30
Cut-off Characteristics gG/gL		500Vac	31
Cut-off Characteristics aM		500Vac	32
Dimensional Data for NH Fuses			33
NH Neutral Links			34
<b>Fuse Bases for NH Fuse Links</b>			
Polyester 1 Pole Fuse Bases for NH Fuse Links			35
Dimensional Data 1 Pole Fuse Bases for NH Fuses			36-37
Fuse Base Terminal Types			38
Steatite 1 Pole Fuse Bases for NH Fuses			39
Dimensional Data 1 Pole Fuse Bases for NH Fuses			40
3 Pole Fuse Bases for NH Fuses			41
Dimensional Data 3 Pole Fuse Bases for NH Fuses			42
<b>Fuse Bases &amp; Fusegear Accessories</b>			
Fuse Extraction Handle			43
Fuse Base Partition Barriers			44
<b>Fuse Bases &amp; Fusegear for NH Fuses</b>			
3 Pole Fuse Rail for NH Fuses			45
Dimensional Drawings Fuse Switch Disconnectors			46
Dimensional Drawings Fuse Rails for NH Fuses			47
Horizontal Fuse Switch - Disconnectors			48
Dimensional Drawings Horizontal Fuse Switch Disconnectors			49-53
Dimensional Drawings Fuse Bases for NH Fuses			54
Fixing Holes & Cut-outs Fuse Bases for NH Fuses			55
Dimensional Drawings Fuse Bases for NH Fuses			56
Vertical Fuse Switch - Disconnectors			57
Dimensional Sketches Vertical Fuse Switch - Disconnectors			58-60

SIZE: C00(000) CLASS: gG/gL

500Vac



DIMENSIONAL DATA ON PAGE 33

- General Industrial applications
- Full range breaking capacity
- Rated at 500Vac to IEC 60269-2-1 (VDE 0636)
- VDE Licence Mark
- Other voltage ratings available, contact Bussmann for further information

### 1 FUSE LINK SELECTION TABLE

Rated Current	Part Number	Watts loss (W)	Breaking Capacity	Weight	Packaging
6	6NHC00G	1.1	120kA @ 500V ac 50kA @ 250V dc	0.130 kg	3 pcs per Carton
10	10NHC00G	1.3			
16	16NHC00G	2.0			
20	20NHC00G	2.2			
25	25NHC00G	3.1			
32	32NHC00G	3.5			
35	35NHC00G	3.8			
40	40NHC00G	4.0			
50	50NHC00G	5.3			
63	63NHC00G	6.1			
80	80NHC00G	6.9			
100	100NHC00G	7.2			

### 2 FUSEHOLDER SELECTION TABLE FOR C00 (000) FUSE LINKS

No.Poles	Part Number	Material	Max Rated Current	Max Watts Loss of Fuse Link	Weight	Packaging
1	SB00	Fibreglass	160A	12W	0.130 kg	3 per box
2	SBS00	Steatite	160A	12W	0.280 kg	1 per box
3	TB00	Fibreglass	160A	12W	0.500 kg	1 per box

### 3 FUSE SWITCH-DISCONNECTOR SELECTION TABLE FOR C00 (000) FUSE LINKS

No.Poles	Part Number	Max Rated Current of Fuse Links	Rated Voltage	Max Watts Loss of Fuse Link	Weight	Packaging
1	LBS00/1	160A	690V ac	12W	0.720 kg	1 per Box
3	LBS00/3					

Electrical Characteristics

SIZE: C00(000) CLASS: gG/gL 500Vac

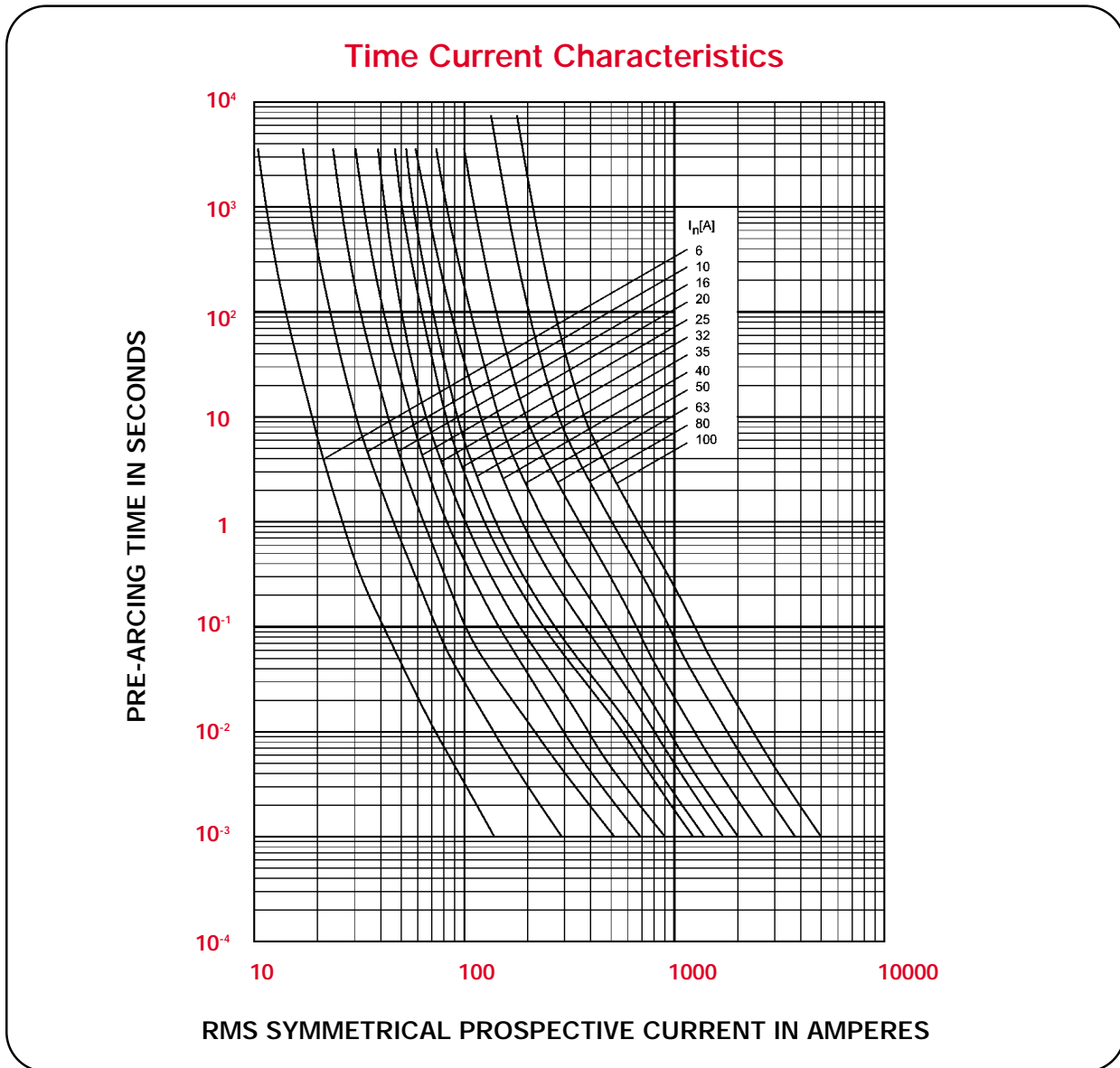

**I<sup>2</sup>t** CHARACTERISTICS

Bussmann Part Number	Rated Current RMS-Amps	I <sup>2</sup> t (A <sup>2</sup> S)		
		Pre Arcing at 500Vac	20 x I <sub>n</sub> at 500Vac	I <sub>1</sub> 120kA at 500Vac
6NHC00G	6	20	140	350
10NHC00G	10	110	500	1100
16NHC00G	16	230	1100	2200
20NHC00G	20	650	1900	4100
25NHC00G	25	1200	3000	6300
32NHC00G	32	2000	5000	10500
35NHC00G	35	3500	6000	12000
40NHC00G	40	4500	8000	18000
50NHC00G	50	4850	14000	25000
63NHC00G	63	6100	29000	42000
80NHC00G	80	7000	39000	80000
100NHC00G	100	14000	55000	130000

SIZE: 00 CLASS: gG/gL

500Vac



DIMENSIONAL DATA ON PAGE 33

- General Industrial applications
- Full range breaking capacity
- Rated at 500Vac
- Approved to IEC 60269-2-1 (VDE 0636)
- Other voltage ratings available, contact Bussmann for further information

### 1 FUSE LINK SELECTION TABLE

Rated Current	Part Number	Watts loss (W)	Breaking Capacity	Weight	Packaging
125	125NH00G	9.1	120kA @ 500V ac 50kA @ 250V dc	0.130 kg	3 pcs per Carton
160	160NH00G	11.2			

### 2 FUSEHOLDER SELECTION TABLE FOR SIZE 00 FUSE LINKS

No.Poles	Part Number	Material	Max Rated Current	Max Watts Loss of Fuse Link	Weight	Packaging
1	SB00	Fibreglass	160A	12W	0.130 kg	3 per box
1	SBS00	Steatite	160A	12W	0.280 kg	1 per box
3	TB00	Fibreglass	160A	12W	0.500 kg	1 per box

### 3 FUSE SWITCH-DISCONNECTOR SELECTION TABLE FOR SIZE 00 FUSE LINKS

No.Poles	Part Number	Max Rated Current of Fuse Links	Rated Voltage	Max Watts Loss of Fuse Link	Weight	Packaging
1	LBS00/1	160A	690V ac	12W	0.720 kg	1 per Box
3	LBS00/3					

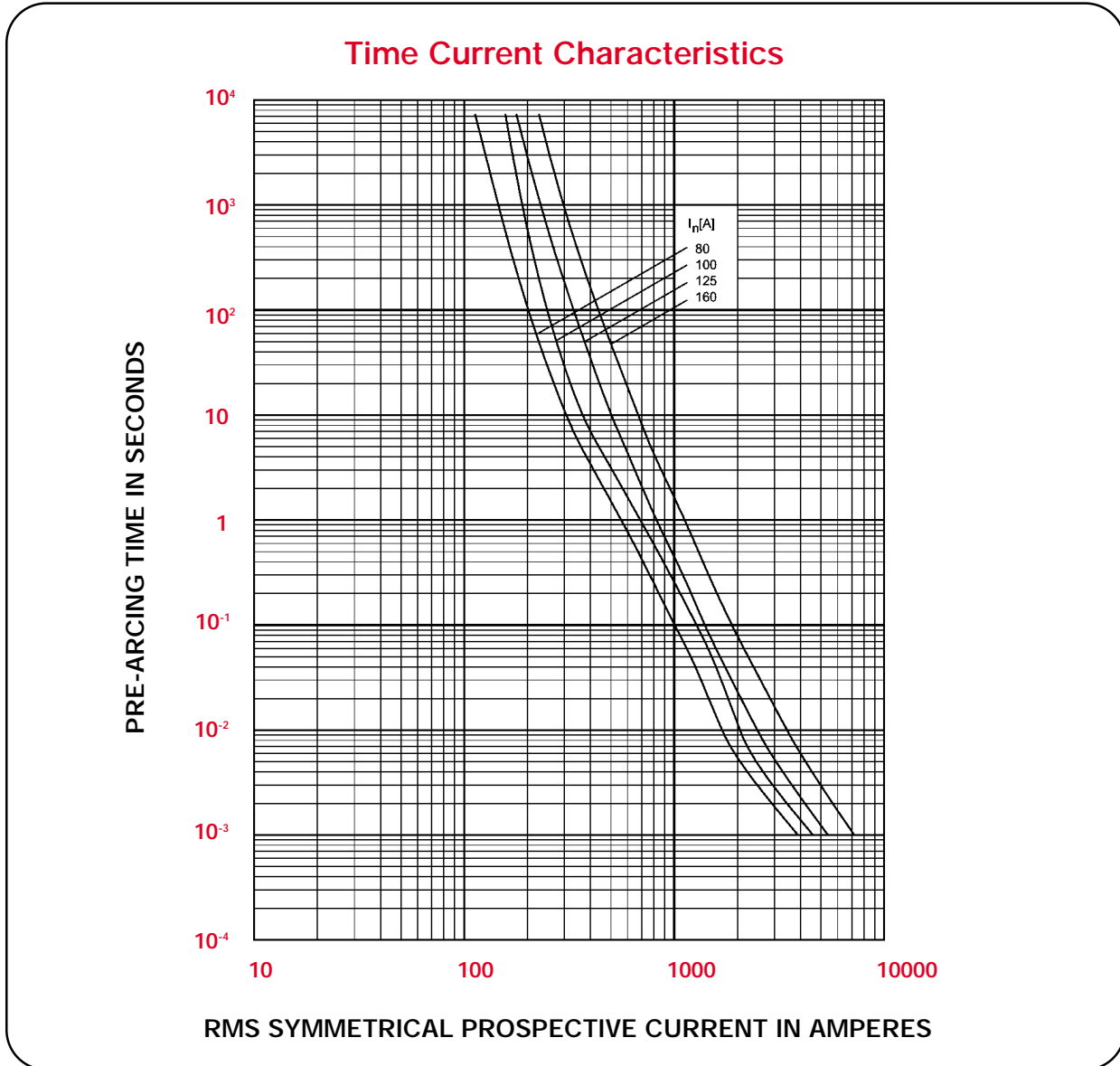

**I<sup>2</sup>t** CHARACTERISTICS

Bussmann Part Number	Rated Current RMS-Amps	I <sup>2</sup> t (A <sup>2</sup> S)		
		Pre Arcing at 500Vac	20 x I <sub>n</sub> at 500Vac	I <sub>1</sub> 120kA at 500Vac
125NH00G	125	31000	88000	190000
160NH00G	160	40000	140000	230000

SIZE: 1 CLASS: gG/gL

500Vac



DIMENSIONAL DATA ON PAGE 33

- General Industrial applications
- Full range breaking capacity
- Rated at 500Vac to IEC 60269-2-1 (VDE 0636)
- VDE Licence Mark
- Reduced body size for ratings <160A
- Other voltage ratings available, contact Bussmann for further information

1 FUSE LINK SELECTION TABLE

Rated Current	Part Number	Watts loss (W)	Breaking Capacity	Weight	Packaging
6	6NH1G	1.5	120kA @ 500V ac 50kA @ 250V dc	0.220 kg	3 pcs per Carton
10	10NH1G	1.8			
16	16NH1G	2.9			
20	20NH1G	3.0			
25	25NH1G	4.3			
32	32NH1G	4.8			
35	35NH1G	4.9			
40	40NH1G	5.6			
50	50NH1G	6.8			
63	63NH1G	7.9			
80	80NH1G	8.2			
100	100NH1G	9.9			
125	125NH1G	11.7			
160	160NH1G	13.8			
200	200NH1G	15.2			
224	224NH1G	17.6		0.430 kg	
225	225NH1G	17.6			
250	250NH1G	20.4			

2 FUSEHOLDER SELECTION TABLE FOR SIZE 01 (1S) & 1 FUSE LINKS

No.Poles	Part Number	Material	Max Rated Current	Max Watts Loss of Fuse Link	Weight	Packaging
1	SB1	Fibreglass	250A	32W	0.360 kg	3 per box
2	SBS1	Steatite	250A	32W	0.700 kg	1 per box
3	TB1	Fibreglass	250A	32W	1.200 kg	1 per box

3 FUSE SWITCH-DISCONNECTOR SELECTION TABLE FOR SIZE 01 (1S) & 1 FUSE LINKS

No.Poles	Part Number	Max Rated Current of Fuse Links	Rated Voltage	Max Watts Loss of Fuse Link	Weight	Packaging
1	LBS1/1	250A	690V ac	32W	2.500 kg	1 per Box
3	LBS1/3					

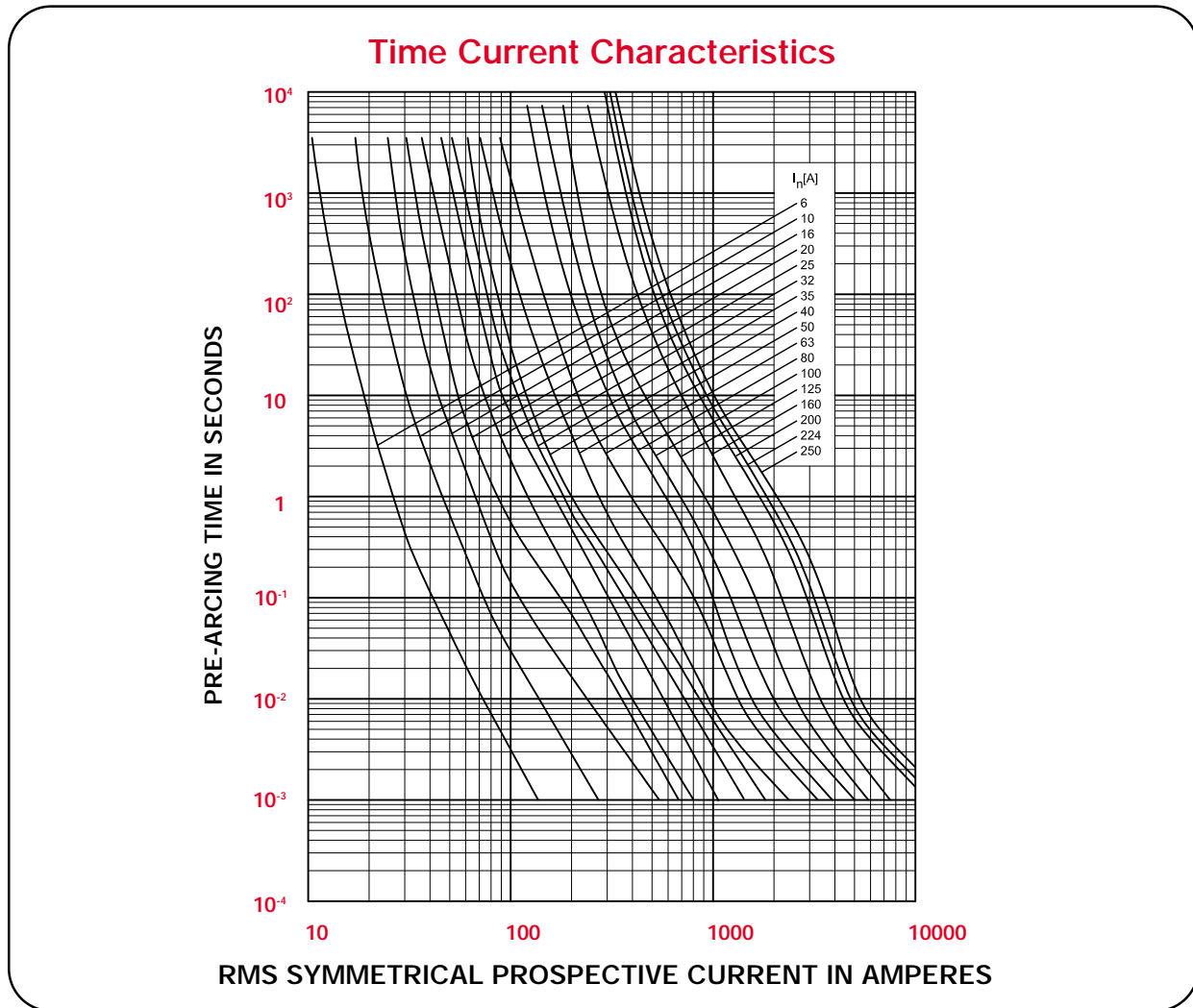

**I<sub>t</sub>** CHARACTERISTICS

Bussmann Part Number	Rated Current RMS-Amps	I <sup>2</sup> t (A <sup>2</sup> S)		
		Pre Arcing at 500Vac	20 x I <sub>n</sub> at 500Vac	I <sub>1</sub> 120kA at 500Vac
6NH1G	6	20	140	350
10NH1G	10	140	500	1100
16NH1G	16	330	1100	2200
20NH1G	20	820	1900	4100
25NH1G	25	1350	3000	6300
32NH1G	32	2000	5000	10500
35NH1G	35	2700	6000	12000
40NH1G	40	4500	8000	18000
50NH1G	50	5000	14000	25000
63NH1G	63	9000	29000	42000
80NH1G	80	13000	39000	80000
100NH1G	100	21000	55000	130000
125NH1G	125	26000	88000	190000
160NH1G	160	55000	120000	230000
200NH1G	200	95000	210000	390000
224NH1G	224	120000	270000	460000
250NH1G	250	140000	390000	580000

SIZE: 2 CLASS: gG/gI

500Vac



DIMENSIONAL DATA ON PAGE 33

- General Industrial applications
- Full range breaking capacity
- Rated at 500Vac: 250Vdc
- Approved to IEC 60269 (VDE 0636)
- Reduced body size for ratings <250A
- Other voltage ratings available, contact Bussmann for further information

### 1 FUSE LINK SELECTION TABLE

Rated Current	Part Number	Watts loss (W)	Breaking Capacity	Weight	Packaging
35	35NH2G	4.0	120kA @ 500V ac 50kA @ 250V dc	0.440 kg	3 pcs per Carton
40	40NH2G	4.6			
50	50NH2G	5.7			
63	63NH2G	6.8			
80	80NH2G	7.2			
100	100NH2G	8.5			
125	125NH2G	11.4			
160	160NH2G	13.0			
200	200NH2G	15.9			
224	224NH2G	20.0			
250	250NH2G	20.5			
315	315NH2G	26.0		0.590 kg	
350	350NH2G	29.0			
400	400NH2G	32.0			

### 2 FUSEHOLDER SELECTION TABLE FOR SIZE 02 (2S) & 2 FUSE LINKS

No.Poles	Part Number	Material	Max Rated Current	Max Watts Loss of Fuse Link	Weight	Packaging
1	SB2	Fibreglass	400A	45W	0.420 kg	3 per box
1	SBS2	Steatite	400A	45W	0.810 kg	1 per box
3	TB2	Fibreglass	400A	45W	1.400 kg	1 per box

### 3 FUSE SWITCH-DISCONNECTOR SELECTION TABLE FOR SIZE 02 (2S) & 2 FUSE LINKS

No.Poles	Part Number	Max Rated Current of Fuse Links	Rated Voltage	Max Watts Loss of Fuse Link	Weight	Packaging
3	LBS2/3	400A	690V ac	45W	3.100 kg	1 per Box



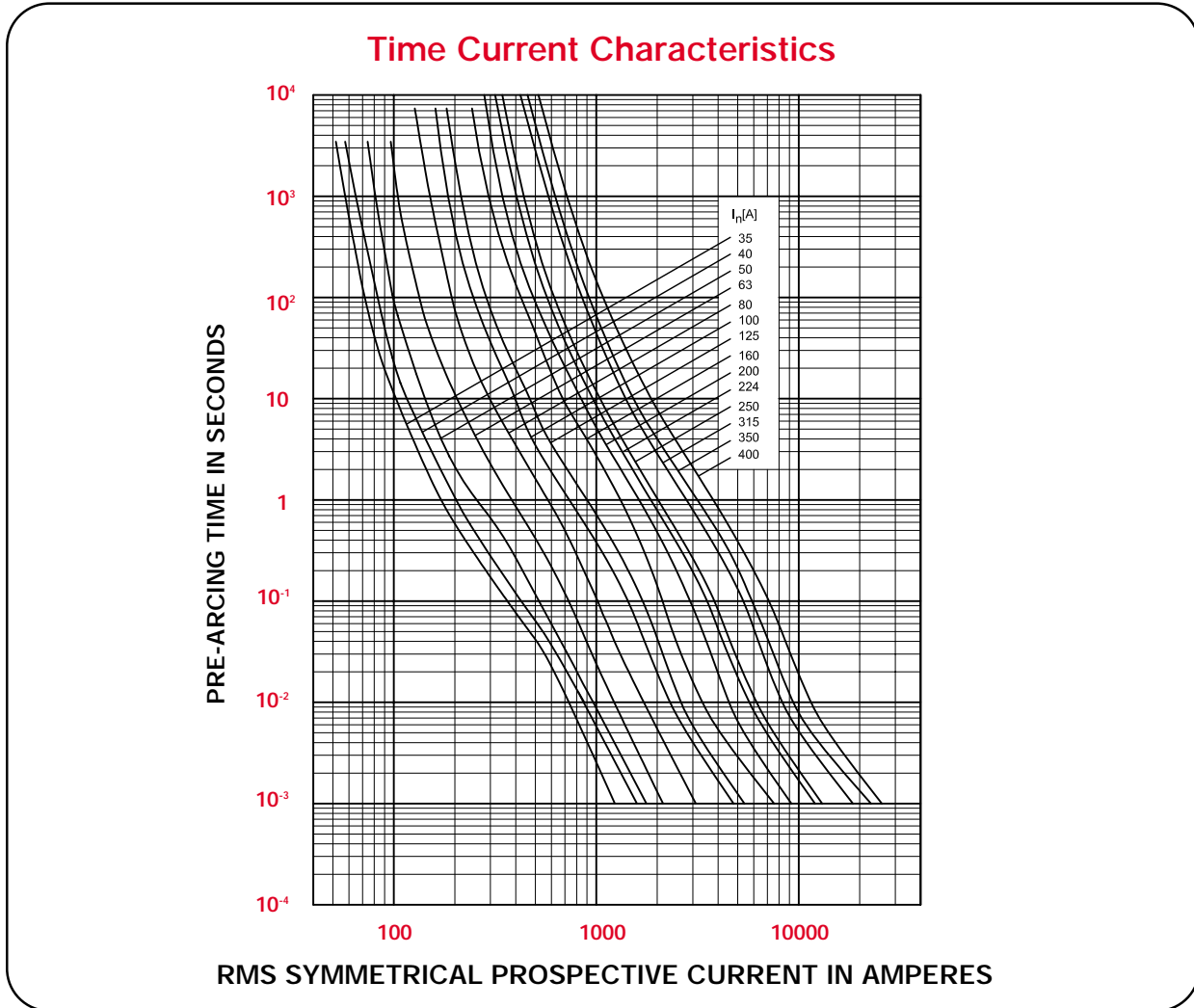

**I<sup>2</sup>t** CHARACTERISTICS

Bussmann Part Number	Rated Current RMS-Amps	I <sup>2</sup> t (A <sup>2</sup> S)		
		Pre Arcing at 500Vac	20 x I <sub>n</sub> at 500Vac	I <sub>1</sub> 120kA at 500Vac
35NH2G	35	2700	6000	12000
40NH2G	40	4000	8000	18000
50NH2G	50	4500	14000	25000
63NH2G	63	7100	29000	42000
80NH2G	80	11000	39000	80000
100NH2G	100	17000	55000	130000
125NH2G	125	24000	88000	190000
160NH2G	160	50000	140000	230000
200NH2G	200	95000	210000	390000
224NH2G	224	120000	270000	460000
250NH2G	250	140000	390000	580000
315NH2G	315	290000	800000	1150000
350NH2G	350	400000	1050000	1350000
400NH2G	400	600000	1500000	2000000

SIZE: 3 CLASS: gG/gL

500Vac



DIMENSIONAL DATA ON PAGE 33

- General Industrial applications
- Full range breaking capacity
- Rated at 500Vac: 250Vdc
- Approved to IEC 60269 (VDE 0636)
- Reduced body size for ratings <400A
- Other voltage ratings available, contact Bussmann for further information

### 1 FUSE LINK SELECTION TABLE

Rated Current	Part Number	Watts loss (W)	Breaking Capacity	Weight	Packaging
100	100NH3G	10.2	120kA @ 500V ac 50kA @ 250V dc	0.610 kg	3 pcs per Carton
125	125NH3G	11.9			
160	160NH3G	15.7			
200	200NH3G	20.1			
224	224NH3G	20.7			
250	250NH3G	24.5			
315	315NH3G	31.3			
350	350NH3G	34.8			
400	400NH3G	38.4			
500	500NH3G	38.0		1.080 kg	
630	630NH3G	48.0			

### 2 FUSEHOLDER SELECTION TABLE FOR SIZE 03 (3S) & 3 FUSE LINKS

No.Poles	Part Number	Material	Max Rated Current	Max Watts Loss of Fuse Link	Weight	Packaging
1	SBS3	Steatite	630A	60W	0.870 kg	1 per box

### 3 FUSE SWITCH-DISCONNECTOR SELECTION TABLE FOR SIZE 03 (3S) & 3 FUSE LINKS

No.Poles	Part Number	Max Rated Current of Fuse Links	Rated Voltage	Max Watts Loss of Fuse Link	Weight	Packaging
1	LBS3/1	630A	690V ac	60W	4.800 kg	1 per Box
3	LBS3/3					

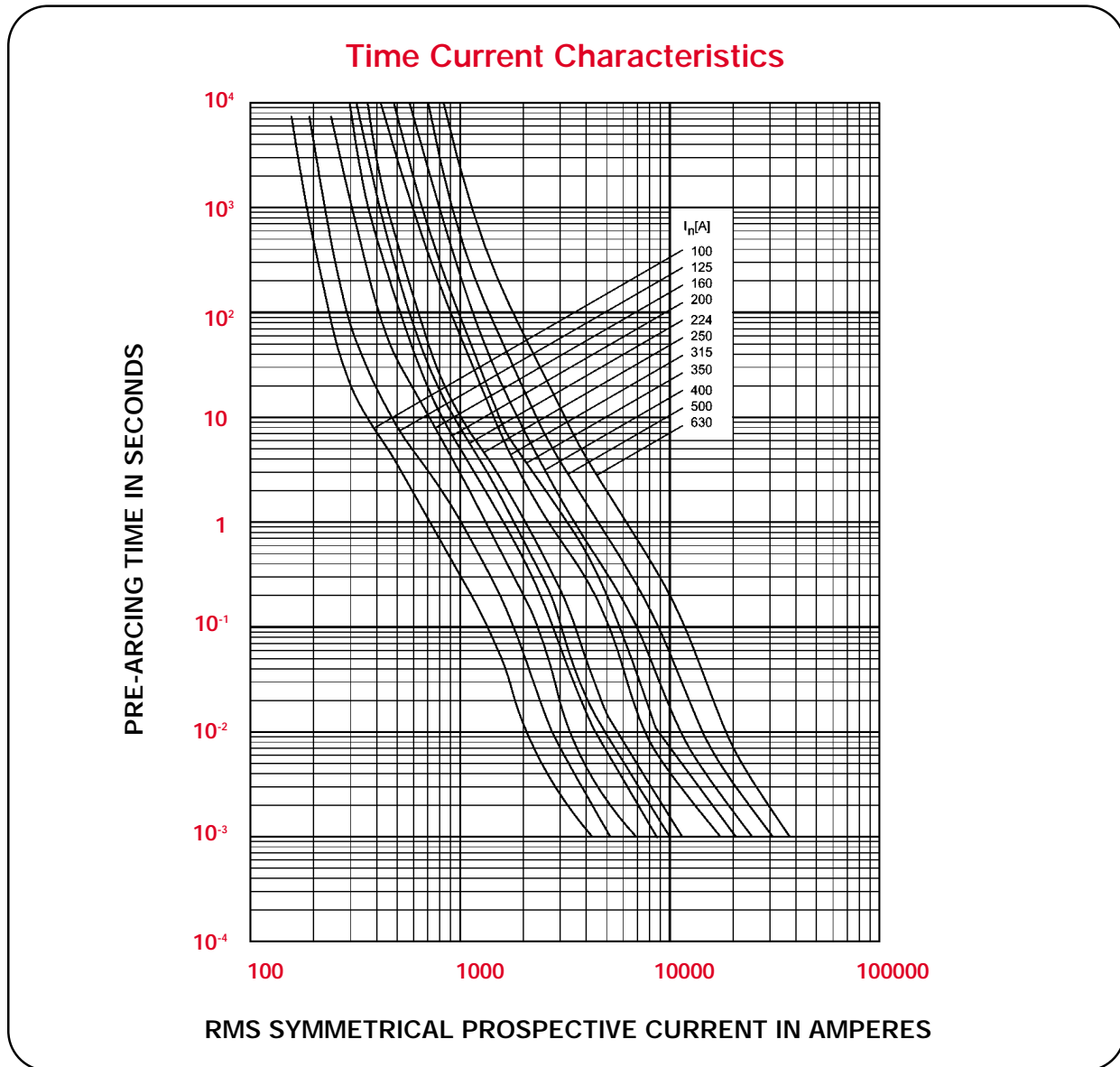

**I<sub>t</sub>** CHARACTERISTICS

Bussmann Part Number	Rated Current RMS-Amps	I <sub>t</sub> (A <sup>2</sup> S)		
		Pre Arcing at 500Vac	20 x I <sub>n</sub> at 500Vac	I <sub>1</sub> 120kA at 500Vac
100NH3G	100	20000	55000	130000
125NH3G	125	40000	88000	190000
160NH3G	160	49000	140000	230000
200NH3G	200	82000	210000	390000
224NH3G	224	120000	270000	460000
250NH3G	250	140000	390000	580000
315NH3G	315	290000	800000	1150000
350NH3G	350	400000	1050000	1350000
400NH3G	400	600000	1500000	2000000
500NH3G	500	770000	2050000	2800000
630NH3G	630	940000	3800000	4300000

SIZE: 4a CLASS: gG/gL

500Vac



**DIMENSIONAL DATA ON PAGE 33**

- General Industrial applications
- Full range breaking capacity
- Rated at 500Vac: 250Vdc
- Approved to IEC 60269 (VDE 0636)
- Other voltage ratings available, contact Bussmann for further information

### 1 FUSE LINK SELECTION TABLE

Rated Current	Part Number	Watts loss (W)	Breaking Capacity	Weight	Packaging
800	800NH4AG	64.0	120kA @ 500V ac 50kA @ 250V dc	2.000 kg	3 pcs per Carton
1000	1000NH4AG	75.0			
1250	1250NH4AG	90.0			
1600	1600NH4AG	130.0			

### 2 FUSE SWITCH-DISCONNECTOR SELECTION TABLE FOR SIZE 4a FUSE LINKS

No.Poles	Part Number	Max Rated Current of Fuse Links	Rated Voltage	Max Watts Loss of Fuse Link	Weight	Packaging
1	LBS4/1	1250A	690V ac	110W	5.600 kg	1 per Box
3	LBS4/3					

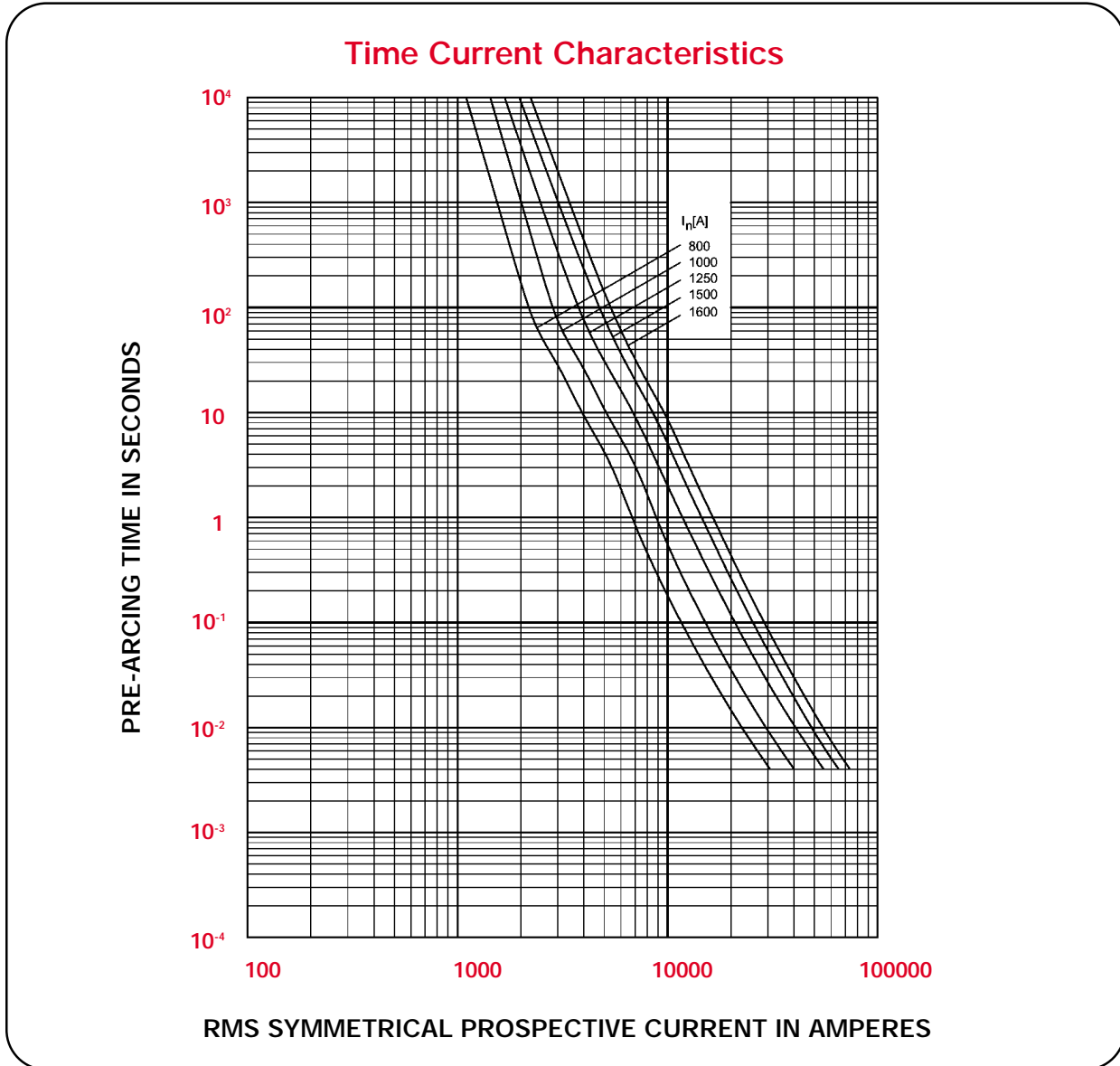

**I<sup>2</sup>t** CHARACTERISTICS

Bussmann Part Number	Rated Current RMS-Amps	I <sup>2</sup> t (A <sup>2</sup> S)		
		Pre Arcing at 500Vac	20 x I <sub>n</sub> at 500Vac	I <sub>1</sub> 120kA at 500Vac
800NH4AG	800	3500000	15000000	18000000
1000NH4AG	1000	6000000	30000000	34000000
1250NH4AG	1250	14000000	58000000	65000000

SIZE: 00 CLASS: gG/gL

690Vac



DIMENSIONAL DATA ON PAGE 33

- General Industrial applications
- Full range breaking capacity
- Rated at 690Vac to IEC 60269-2-1 (VDE 0636)
- Contact Bussmann for further information

## 1 FUSE LINK SELECTION TABLE

Rated Current	Part Number	Watts loss (W)	Breaking Capacity	Weight	Packaging
10	10NH00G - 690	1.5	120kA @ 690Vac 50kA @ 250Vdc	0.150 kg	3 pcs per Carton
16	16NH00G - 690	1.9			
20	20NH00G - 690	2.8			
25	25NH00G - 690	3.5			
32	32NH00G - 690	4.2			
40	40NH00G - 690	5.2			
50	50NH00G - 690	6.0			
63	63NH00G - 690	6.2			
80	80NH00G - 690	6.8			
100	100NH00G - 690	7.2			

## 2 FUSEHOLDER SELECTION TABLE FOR C00 (000) FUSE LINKS

No.Poles	Part Number	Material	Max Rated Current	Max Watts Loss of Fuse Link	Weight	Packaging
1	SB00	Fibreglass	160A	12W	0.130 kg	3 per box
2	SBS00	Steatite	160A	12W	0.280 kg	1 per box
3	TB00	Fibreglass	160A	12W	0.500 kg	1 per box

## 3 FUSE SWITCH-DISCONNECTOR SELECTION TABLE FOR C00 (000) FUSE LINKS

No.Poles	Part Number	Max Rated Current of Fuse Links	Rated Voltage	Max Watts Loss of Fuse Link	Weight	Packaging
1	LBS00/1	160A	690V ac	12W	0.720 kg	1 per Box
3	LBS00/3					

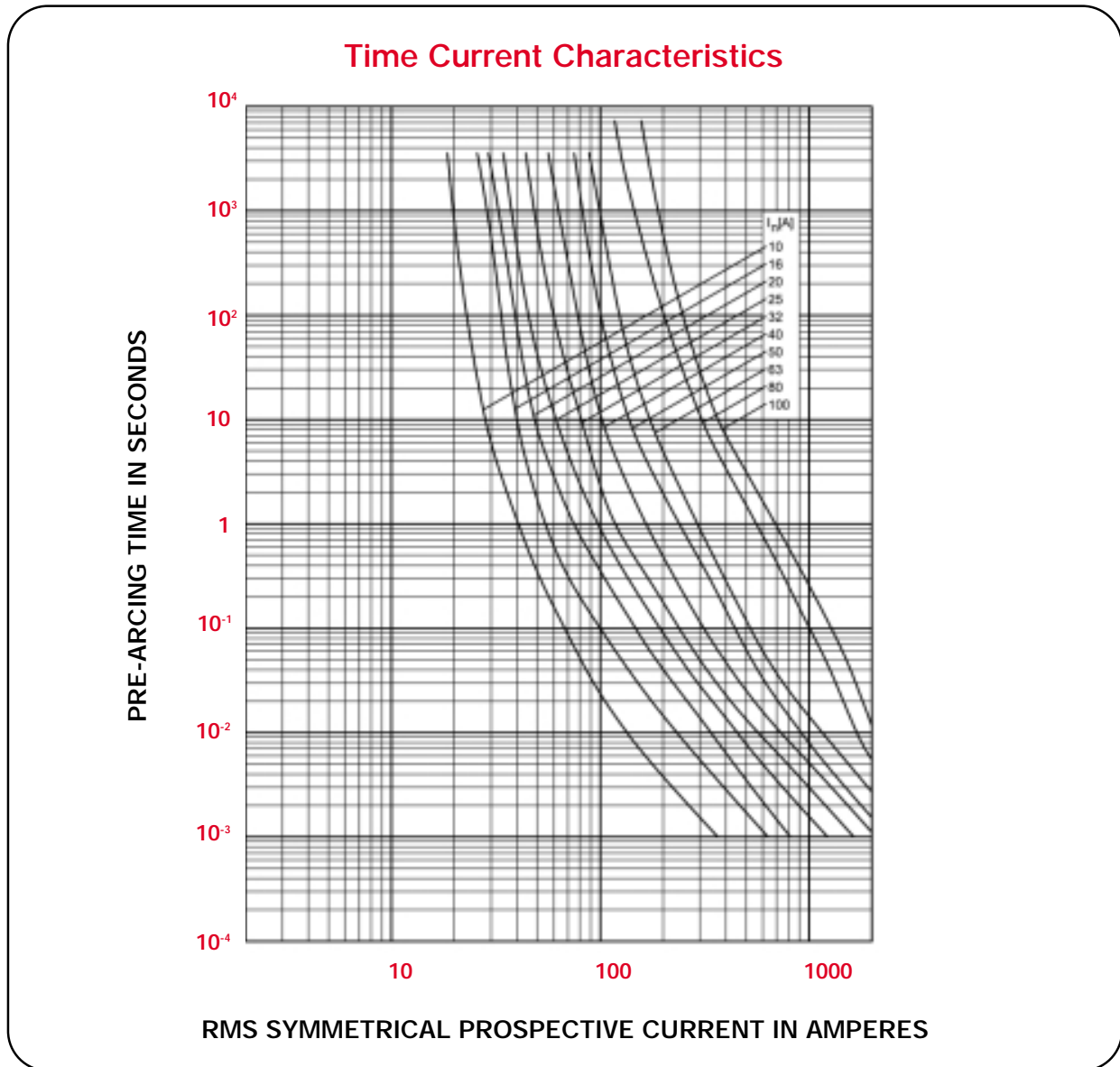

**I<sup>2</sup>t** CHARACTERISTICS

Bussmann Part Number	Rated Current RMS-Amps	I <sup>2</sup> t (A <sup>2</sup> S)		
		Pre Arcing at 690Vac	20 x I <sub>r</sub> at 690Vac	I <sub>1</sub> 120kA at 690Vac
10NH00G-690	10	170	500	1200
16NH00G-690	16	440	1700	2800
20NH00G-690	20	800	2600	5100
25NH00G-690	25	1400	4800	9000
32NH00G-690	32	2500	7300	11000
40NH00G-690	40	4500	13000	21000
50NH00G-690	50	4850	18000	27000
63NH00G-690	63	6100	31000	54000
80NH00G-690	80	7000	60000	110000
100NH00G-690	100	14000	95000	180000

SIZE: 1 CLASS: gG/gI

690Vac



DIMENSIONAL DATA ON PAGE 33

- General Industrial applications
- Full range breaking capacity
- Rated at 690Vac to IEC 60269-2-1 (VDE 0636)
- Reduced body size for ratings <100A
- Contact Bussmann for further information

### 1 FUSE LINK SELECTION TABLE

Rated Current	Part Number	Watts loss (W)	Breaking Capacity	Weight	Packaging
32	32NH1G - 690	4.8	120kA @ 690Vac 50kA @ 250Vdc	0.220 kg	3 pcs per Carton
40	40NH1G - 690	5.6			
50	50NH1G - 690	6.8			
63	63NH1G - 690	7.9			
80	80NH1G - 690	8.2			
100	100NH1G - 690	9.9			
125	125NH1G - 690	10.6		0.430 kg	
160	160NH1G - 690	12.0			
200	200NH1G - 690	15.2			
224	224NH1G - 690	17.6			
225	225NH1G - 690	17.6			
250	250NH1G - 690	20.4			

### 2 FUSEHOLDER SELECTION TABLE FOR SIZE 01 (1S) & 1 FUSE LINKS

No.Poles	Part Number	Material	Max Rated Current	Max Watts Loss of Fuse Link	Weight	Packaging
1	SB1	Fibreglass	250A	32W	0.360 kg	3 per box
2	SBS1	Steatite	250A	32W	0.700 kg	1 per box
3	TB1	Fibreglass	250A	32W	1.200 kg	1 per box

### 3 FUSE SWITCH-DISCONNECTOR SELECTION TABLE FOR SIZE 01 (1S) & 1 FUSE LINKS

No.Poles	Part Number	Max Rated Current of Fuse Links	Rated Voltage	Max Watts Loss of Fuse Link	Weight	Packaging
1	LBS1/1	250A	690V ac	32W	2.500 kg	1 per Box
3	LBS1/3					



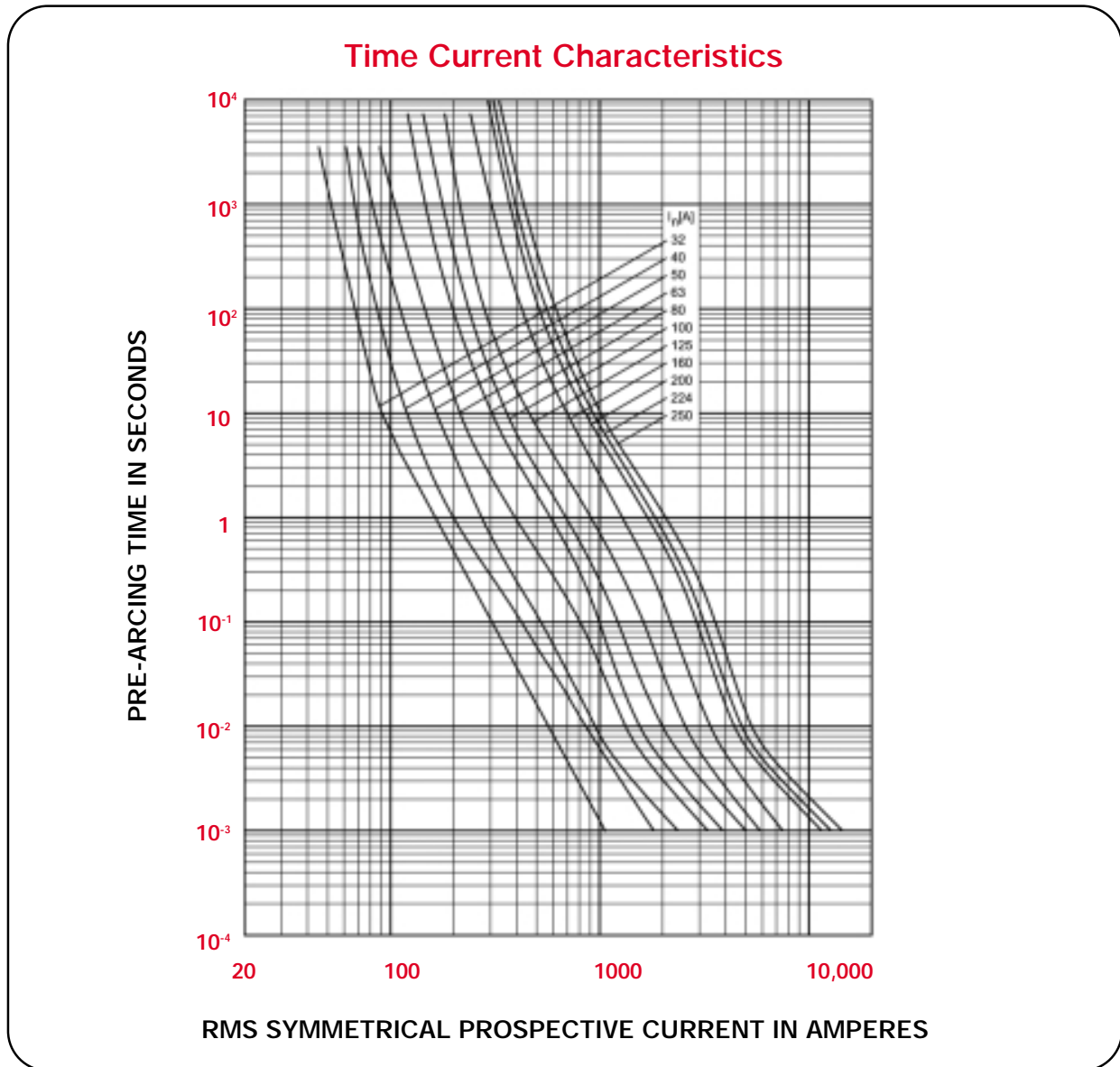

**I<sup>2</sup>t** CHARACTERISTICS

Bussmann Part Number	Rated Current RMS-Amps	I <sup>2</sup> t (A <sup>2</sup> S)		
		Pre Arcing at 690Vac	20 x I <sub>n</sub> at 690Vac	I <sub>1</sub> 120kA at 690Vac
32NH1G-690	32	2600	5500	11000
40NH1G-690	40	4500	9500	20000
50NH1G-690	50	5800	16000	30000
63NH1G-690	63	9500	32000	45000
80NH1G-690	80	14000	43000	95000
100NH1G-690	100	22000	70000	160000
125NH1G-690	125	38000	110000	220000
160NH1G-690	160	65000	170000	330000
200NH1G-690	200	110000	280000	540000
224NH1G-690	224	160000	340000	630000
250NH1G-690	250	190000	400000	750000

SIZE: 2 CLASS: gG/gL

690Vac



DIMENSIONAL DATA ON PAGE 33

- General Industrial applications
- Full range breaking capacity
- Rated at 690Vac to IEC 60269-2-1 (VDE 0636)
- Contact Bussmann for further information

### 1 FUSE LINK SELECTION TABLE

Rated Current	Part Number	Watts loss (W)	Breaking Capacity	Weight	Packaging
100	100NH2G - 690	8.5	120kA @ 690Vac 50kA @ 250Vdc	0.590 kg	3 pcs per Carton
125	125NH2G - 690	10.5			
160	160NH2G - 690	13.5			
200	200NH2G - 690	18.0			
224	224NH2G - 690	20.5			
250	250NH2G - 690	23.0			
315	315NH2G - 690	26.0			
350	350NH2G - 690	29.0			
400	400NH2G - 690	32.0			

### 2 FUSEHOLDER SELECTION TABLE FOR SIZE 02 (2S) & 2 FUSE LINKS

No.Poles	Part Number	Material	Max Rated Current	Max Watts Loss of Fuse Link	Weight	Packaging
1	SB2	Fibreglass	400A	45W	0.420 kg	3 per box
1	SBS2	Steatite	400A	45W	0.810 kg	1 per box
3	TB2	Fibreglass	400A	45W	1.400 kg	1 per box

### 3 FUSE SWITCH-DISCONNECTOR SELECTION TABLE FOR SIZE 02 (2S) & 2 FUSE LINKS

No.Poles	Part Number	Max Rated Current of Fuse Links	Rated Voltage	Max Watts Loss of Fuse Link	Weight	Packaging
3	LBS2/3	400A	690V ac	45W	3.100 kg	1 per Box

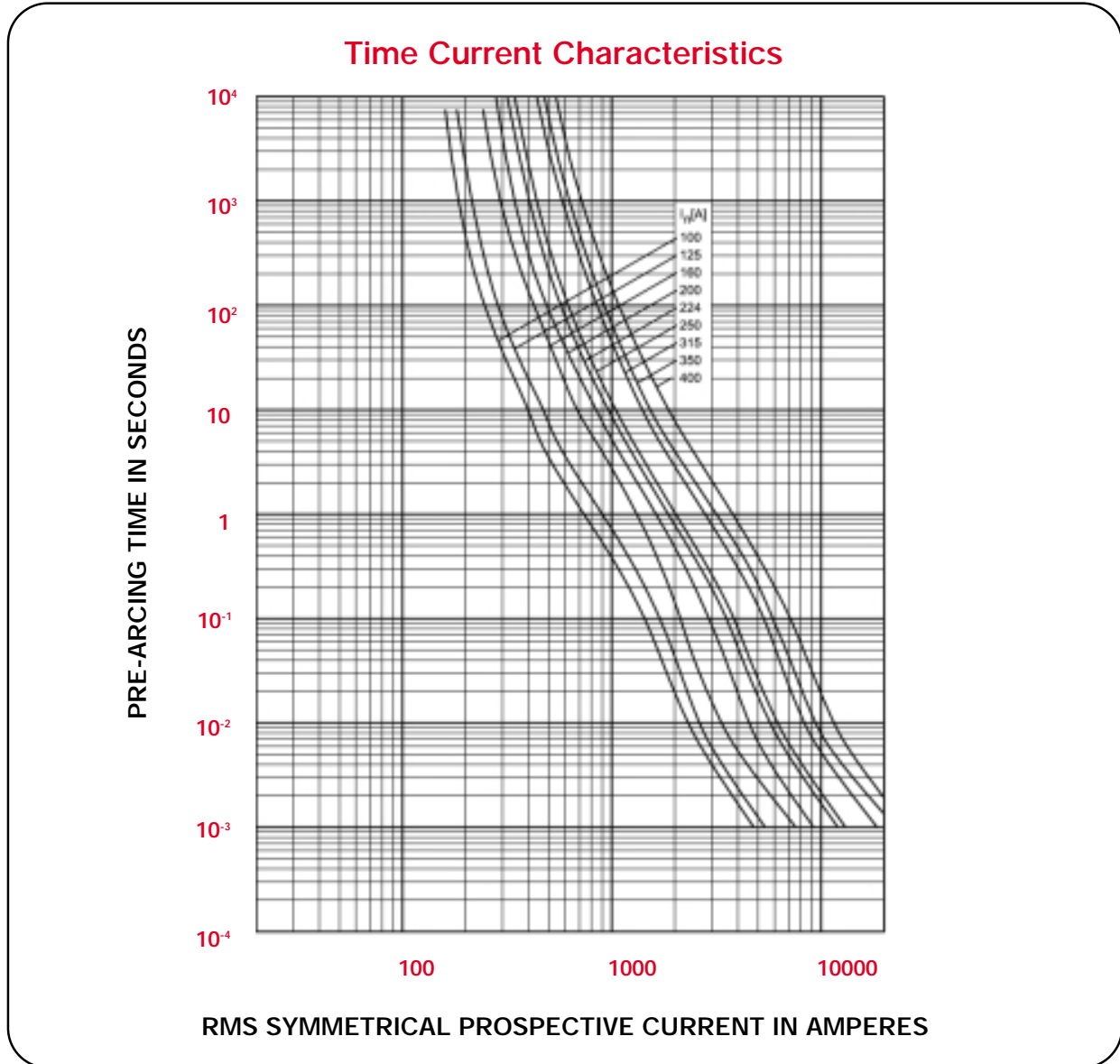

**I<sup>2</sup>t CHARACTERISTICS**

Bussmann Part Number	Rated Current RMS-Amps	I <sup>2</sup> t (A <sup>2</sup> S)		
		Pre Arcing at 690Vac	20 x I <sub>n</sub> at 690Vac	I <sub>1</sub> 120kA at 690Vac
100NH2G-690	100	29000	100000	180000
125NH2G-690	125	39000	120000	270000
160NH2G-690	160	66000	210000	320000
200NH2G-690	200	110000	300000	420000
224NH2G-690	224	170000	450000	630000
250NH2G-690	250	190000	550000	830000
315NH2G-690	315	310000	1250000	1400000
350NH2G-690	350	480000	1400000	1800000
400NH2G-690	400	590000	1700000	2300000

SIZE: 3 CLASS: gG/gL

690Vac



DIMENSIONAL DATA ON PAGE 33

- General Industrial applications
- Full range breaking capacity
- Rated at 690Vac to IEC 60269-2-1 (VDE 0636)
- Contact Bussmann for further information

### 1 FUSE LINK SELECTION TABLE

Rated Current	Part Number	Watts loss (W)	Breaking Capacity	Weight	Packaging
315	315NH3G - 690	27.0	120kA @ 690Vac 50kA @ 250Vdc	1.080 kg	3 pcs per Carton
350	350NH3G - 690	30.0			
400	400NH3G - 690	32.4			
500	500NH3G - 690	38.0			
630	630NH3G - 690	-			

### 2 FUSEHOLDER SELECTION TABLE FOR SIZE 03 (3S) & 3 FUSE LINKS

No.Poles	Part Number	Material	Max Rated Current	Max Watts Loss of Fuse Link	Weight	Packaging
1	SBS3	Steatite	630A	60W	0.870 kg	1 per box

### 3 FUSE SWITCH-DISCONNECTOR SELECTION TABLE FOR SIZE 03 (3S) & 3 FUSE LINKS

No.Poles	Part Number	Max Rated Current of Fuse Links	Rated Voltage	Max Watts Loss of Fuse Link	Weight	Packaging
1	LBS3/1	630A	690V ac	60W	4.800 kg	1 per Box
3	LBS3/3					

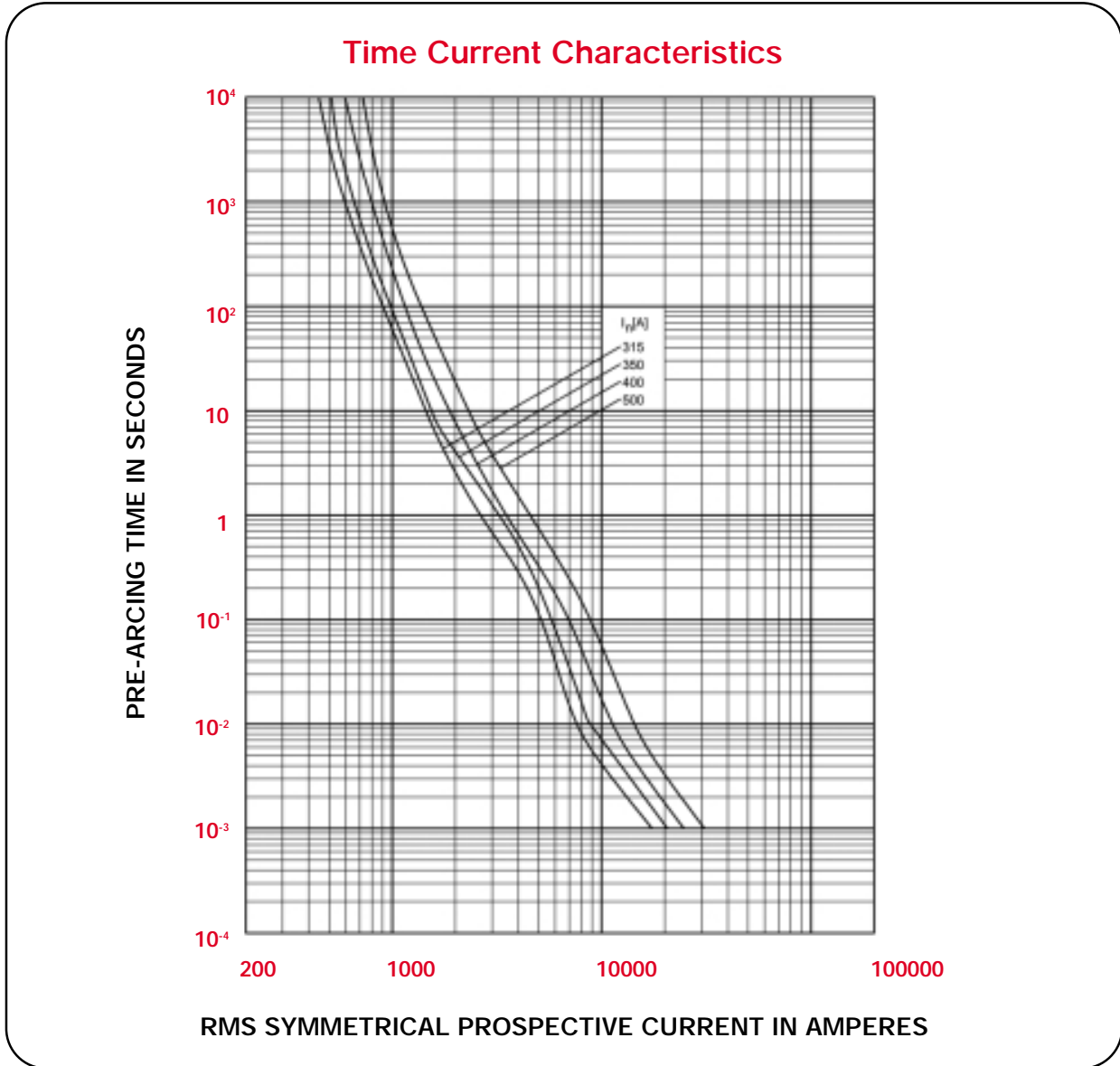

**I<sup>2</sup>t** CHARACTERISTICS

Bussmann Part Number	Rated Current RMS-Amps	I <sup>2</sup> t (A <sup>2</sup> S)		
		Pre Arcing at 690Vac	20 x I <sub>n</sub> at 690Vac	I <sub>1</sub> 120kA at 690Vac
315NH3G-690	315	350000	1300000	1600000
350NH3G-690	350	470000	1600000	2200000
400NH3G-690	400	590000	2300000	2800000
500NH3G-690	500	990000	3000000	3900000
630NH3G-690	630	-	-	-

SIZE: C00 (000) CLASS: aM

500Vac



DIMENSIONAL DATA ON PAGE 33

- For the protection of motor circuits
- Partial range breaking capacity
- Rated at 500Vac to IEC 60269-2-1 (VDE 0636)
- VDE Licence Mark
- Other voltage ratings available, contact Bussmann for further information

### 1 FUSE LINK SELECTION TABLE

Rated Current	Part Number	Watts loss (W)	Breaking Capacity	Weight	Packaging
4	4NHC00M	0.4	120kA @ 500V ac	0.130 kg	3 pcs per Carton
6	6NHC00M	0.5			
8	8NHC00M	0.6			
10	10NHC00M	0.6			
12	12NHC00M	0.7			
16	16NHC00M	0.9			
20	20NHC00M	1.1			
25	25NHC00M	1.4			
32	32NHC00M	1.8			
40	40NHC00M	2.4			
50	50NHC00M	3.1			

### 2 FUSEHOLDER SELECTION TABLE FOR SIZE C00 (000) FUSE LINKS

No.Poles	Part Number	Material	Max Rated Current	Max Watts Loss of Fuse Link	Weight	Packaging
1	SB00	Fibreglass	160A	12W	0.130 kg	3 per box
1	SBS00	Steatite	160A	12W	0.280 kg	1 per box
3	TB00	Fibreglass	160A	12W	0.500 kg	1 per box

### 3 FUSE SWITCH-DISCONNECTOR SELECTION TABLE FOR SIZE C00 (000) FUSE LINKS

No.Poles	Part Number	Max Rated Current of Fuse Links	Rated Voltage	Max Watts Loss of Fuse Link	Weight	Packaging
1	LBS00/1	160A	690A ac	12W	0.720 kg	1 per Box
3	LBS00/3					

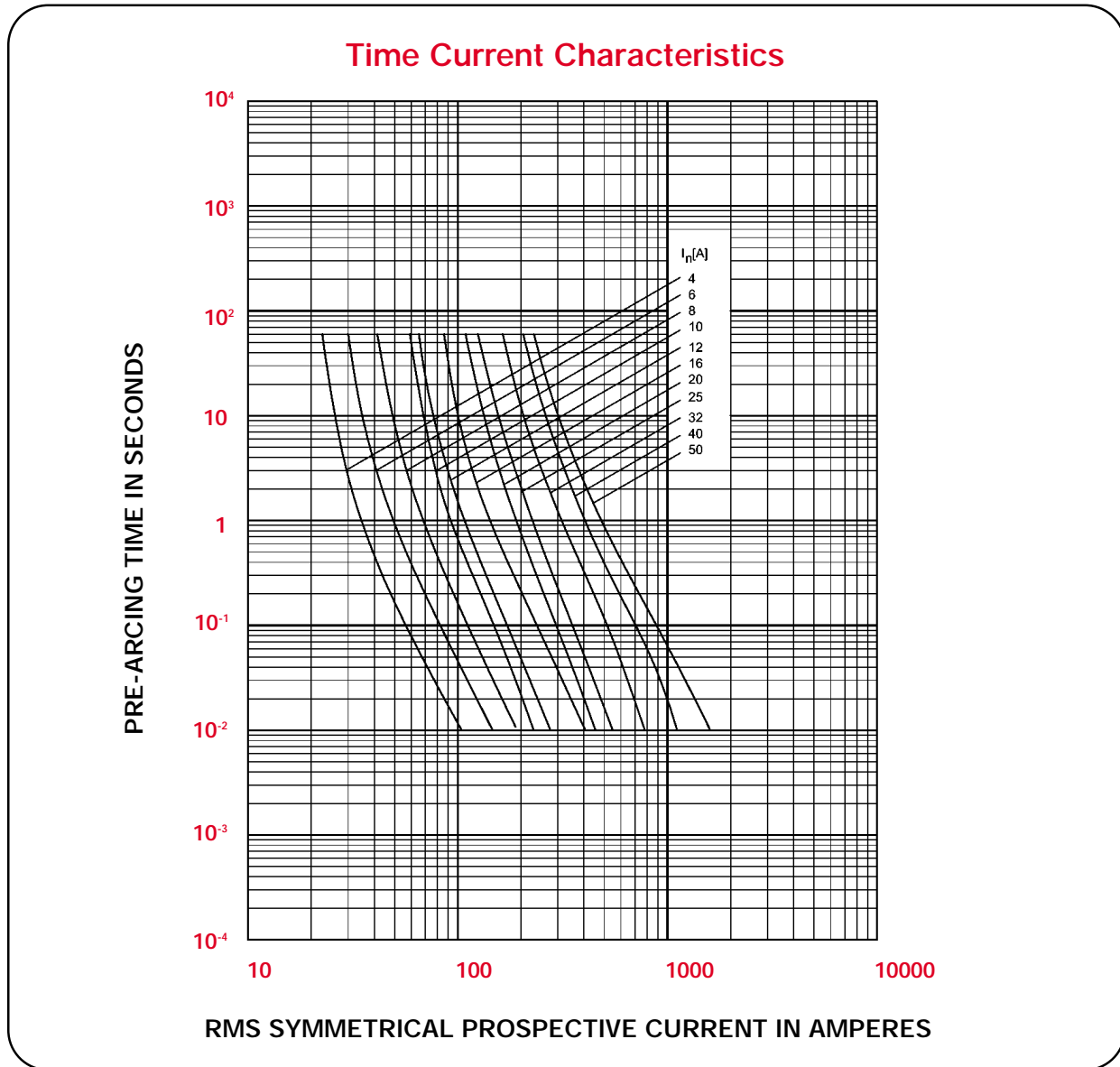

**I<sup>2</sup>t** CHARACTERISTICS

Bussmann Part Number	Rated Current RMS-Amps	I <sup>2</sup> t (A <sup>2</sup> S)		
		Pre Arcing at 500Vac	20 x I <sub>n</sub> at 500Vac	I <sub>1</sub> 120kA at 500Vac
4NHC00M	4	31	80	330
6NHC00M	6	64	210	820
8NHC00M	8	93	390	1500
10NHC00M	10	290	1100	3700
12NHC00M	12	290	1600	4900
16NHC00M	16	700	2100	6900
20NHC00M	20	860	2700	8300
25NHC00M	25	1300	3700	11000
32NHC00M	32	3000	8000	21000
40NHC00M	40	6000	12000	32000
50NHC00M	50	10000	20000	47000

SIZE: 00 CLASS: aM

500Vac



DIMENSIONAL DATA ON PAGE 33

- For the protection of motor circuits
- Partial range breaking capacity
- Rated at 500Vac to IEC 60269-2-1 (VDE 0636)
- VDE Licence Mark
- Other voltage ratings available, contact Bussmann for further information

### 1 FUSE LINK SELECTION TABLE

Rated Current	Part Number	Watts loss (W)	Breaking Capacity	Weight	Packaging
63	63NH00M	4.6	120kA @ 500V ac	0.130 kg	3 pcs per Carton
80	80NH00M	6.8			
100	100NH00M	7.5			

### 2 FUSEHOLDER SELECTION TABLE FOR SIZE 00 FUSE LINKS

No.Poles	Part Number	Material	Max Rated Current	Max Watts Loss of Fuse Link	Weight	Packaging
1	SB00	Fibreglass	160A	12W	0.130 kg	3 per box
1	SBS00	Steatite	160A	12W	0.280 kg	1 per box
3	TB00	Fibreglass	160A	12W	0.500 kg	1 per box

### 3 FUSE SWITCH-DISCONNECTOR SELECTION TABLE FOR SIZE 00 FUSE LINKS

No.Poles	Part Number	Max Rated Current of Fuse Links	Rated Voltage	Max Watts Loss of Fuse Link	Weight	Packaging
1	LBS00/1	160A	690V ac	12W	0.720 kg	1 per Box
3	LBS00/3					



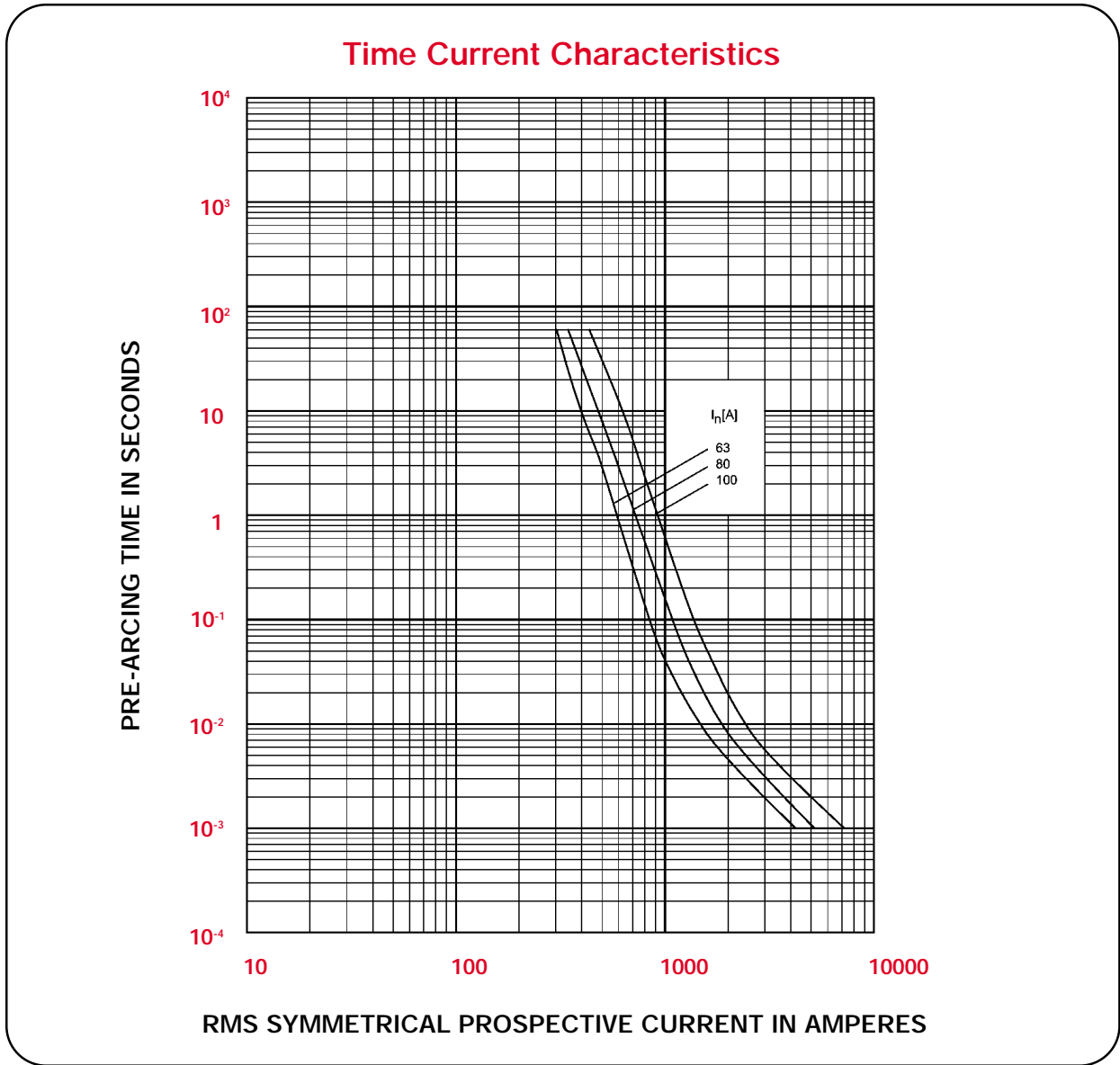

**I<sup>2</sup>t** CHARACTERISTICS

Bussmann Part Number	Rated Current RMS-Amps	I <sup>2</sup> t (A <sup>2</sup> S)		
		Pre Arcing at 500Vac	20 x I <sub>n</sub> at 500Vac	I <sub>1</sub> 120kA at 500Vac
63NH00M	63	1700	35000	75000
80NH00M	80	3400	50000	110000
100NH00M	100	16800	100000	190000

SIZE: 1 CLASS: aM

500Vac



DIMENSIONAL DATA ON PAGE 33

- For the protection of motor circuits
- Partial range breaking capacity
- Rated at 500Vac to IEC 60269-2-1 (VDE 0636)
- VDE Licence Mark
- Reduced body size for ratings <160A
- Other voltage ratings available, contact Bussmann for further information

## 1 FUSE LINK SELECTION TABLE

Rated Current	Part Number	Watts loss (W)	Breaking Capacity	Weight	Packaging
40	40NH1M	3.3	120kA @ 500V ac 50kA @ 250V dc	0.220 kg	3 pcs per Carton
50	50NH1M	4.2			
63	63NH1M	5.4			
80	80NH1M	7.1			
100	100NH1M	7.4			
125	125NH1M	8.3			
160	160NH1M	11.7			
200	200NH1M	17.0			
250	250NH1M	19.5			

## 2 FUSEHOLDER SELECTION TABLE FOR SIZE 01 (1S) & 1 FUSE LINKS

No.Poles	Part Number	Material	Max Rated Current	Max Watts Loss of Fuselink	Weight	Packaging
1	SB1	Fibreglass	160A	32W	0.360 kg	3 per box
1	SBS1	Steatite	160A	32W	0.700 kg	1 per box
3	TB1	Fibreglass	160A	32W	1.200 kg	1 per box

## 3 FUSE SWITCH-DISCONNECTOR SELECTION TABLE FOR SIZE 01 (1S) & 1 FUSE LINKS

No.Poles	Part Number	Max Rated Current of Fuse Links	Rated Voltage	Max Watts Loss of Fuselink	Weight	Packaging
1	LBS1/1	250A	690A ac	32W	2.500 kg	1 per Box
3	LBS1/3					

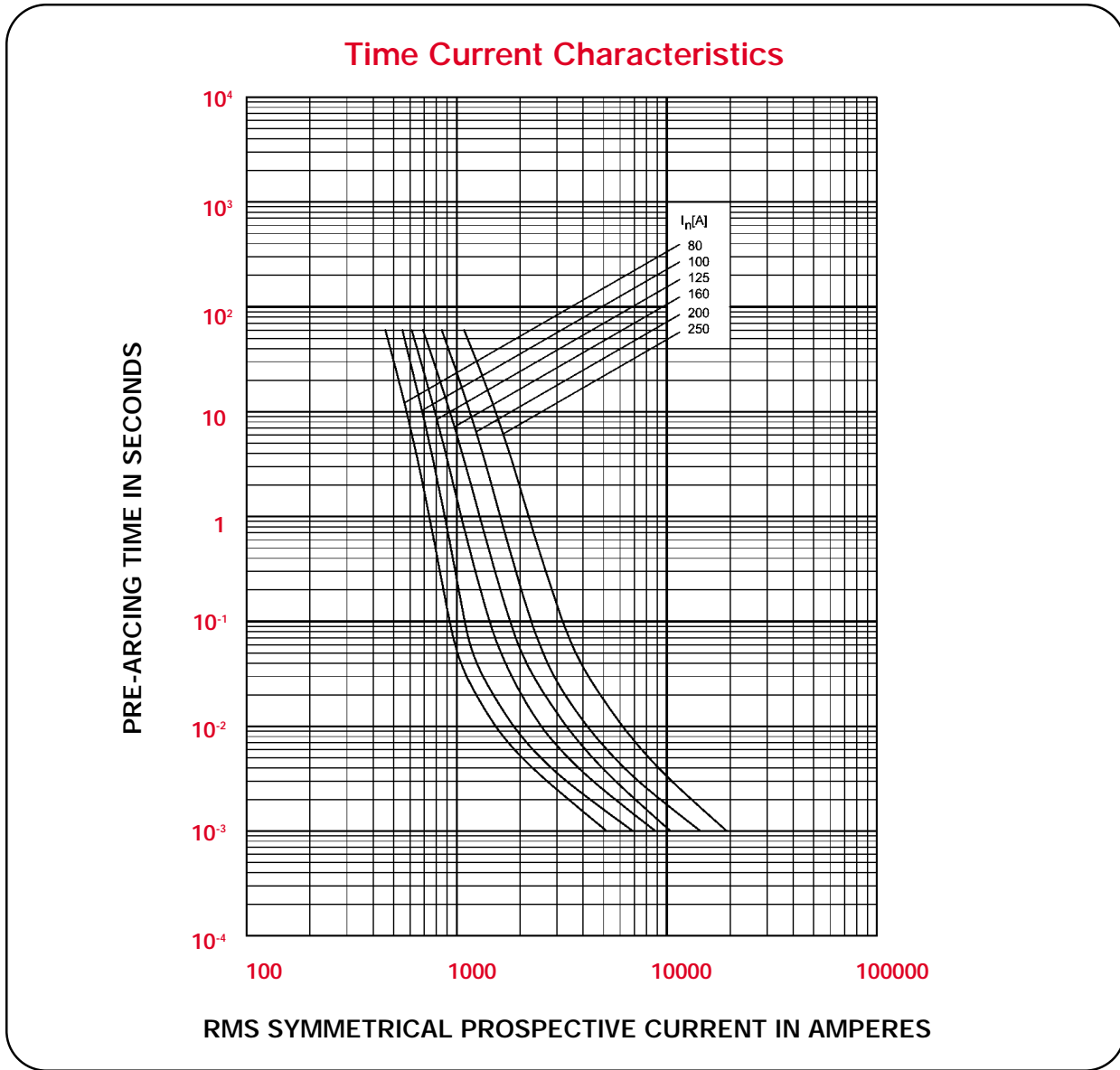

**I<sup>2</sup>t** CHARACTERISTICS

Bussmann Part Number	Rated Current RMS-Amps	I <sup>2</sup> t (A <sup>2</sup> S)		
		Pre Arcing at 500Vac	20 x I <sub>n</sub> at 500Vac	I <sub>1</sub> 120kA at 500Vac
40NH1M	40	1200	12000	32000
50NH1M	50	1850	20000	47000
63NH1M	63	2100	35000	75000
80NH1M	80	3200	50000	110000
100NH1M	100	7000	100000	190000
125NH1M	125	11100	120000	220000
160NH1M	160	20800	190000	310000
200NH1M	200	29000	300000	500000
250NH1M	250	56000	510000	850000

SIZE: 2 CLASS: aM

500Vac



**DIMENSIONAL DATA ON PAGE 33**

- For the protection of motor circuits
- Partial range breaking capacity
- Rated at 500Vac to IEC 60269-2-1 (VDE 0636)
- VDE Licence Marked
- Reduced body size for ratings <250A
- Other voltage ratings available, contact Bussmann for further information

### 1 FUSE LINK SELECTION TABLE

Rated Current	Part Number	Watts loss (W)	Breaking Capacity	Weight	Packaging
125	125NH2M	8.6	120kA @ 500V ac 50kA @ 250V dc	0.440 kg	3 pcs per Carton
160	160NH2M	12.5			
200	200NH2M	16.0			
250	250NH2M	18.5			
315	315NH2M	28.0			
400	400NH2M	34.0			

### 2 FUSEHOLDER SELECTION TABLE FOR SIZE 02 (2S) & 2 FUSE LINKS

No.Poles	Part Number	Material	Max Rated Current	Max Watts Loss of Fuse Link	Weight	Packaging
1	SB2	Fibreglass	400A	45W	0.420 kg	3 per box
1	SBS2	Steatite	400A	45W	0.810 kg	1 per box
3	TB2	Fibreglass	400A	45W	1.400 kg	1 per box

### 3 FUSE SWITCH-DISCONNECTOR SELECTION TABLE FOR SIZE 02 (2S) & 2 FUSE LINKS

No.Poles	Part Number	Max Rated Current of Fuse Links	Rated Voltage	Max Watts Loss of Fuse Link	Weight	Packaging
3	LBS2/3	400A	690V ac	45W	3.100 kg	1 per Box

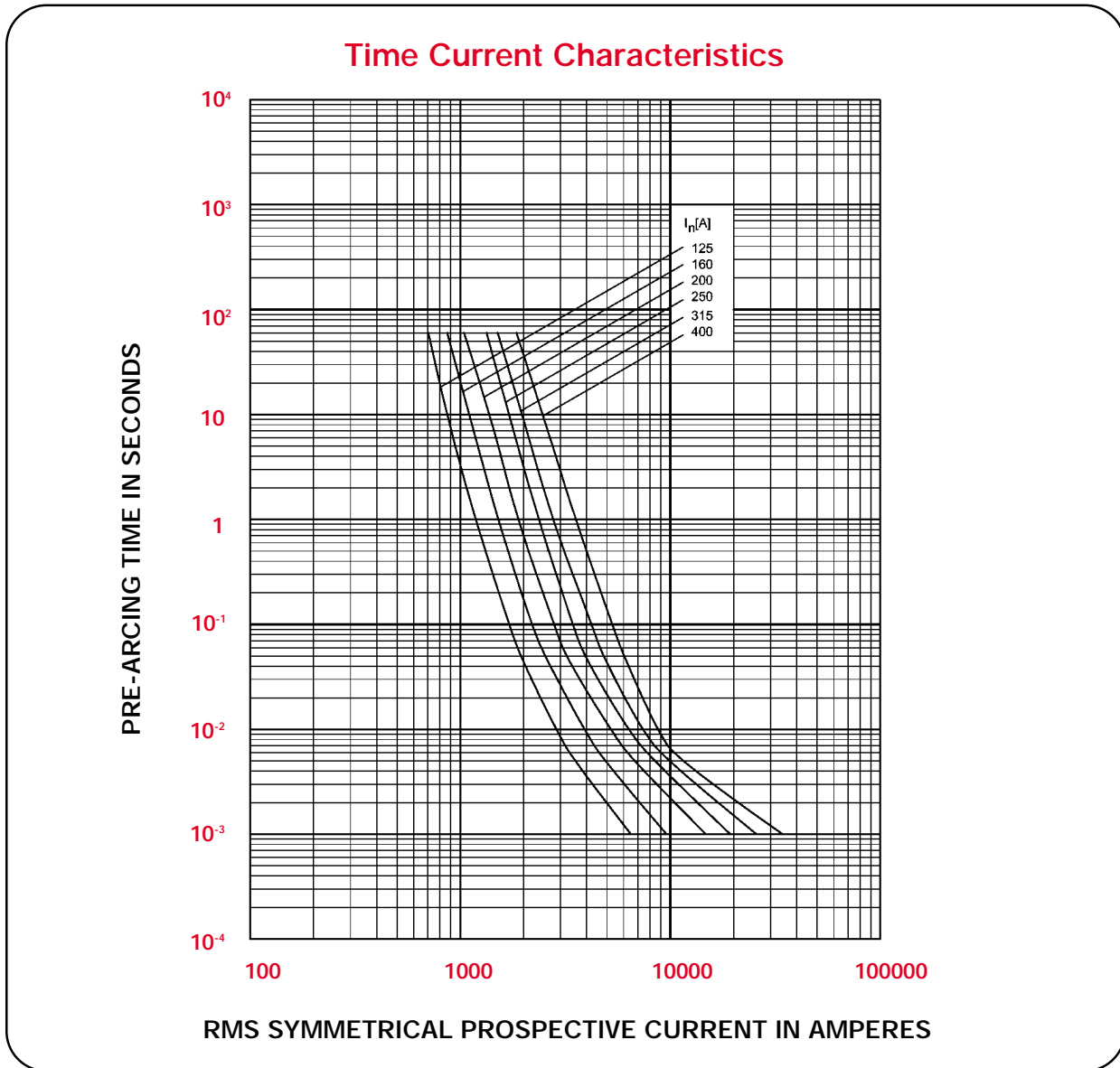

**I<sub>t</sub>** CHARACTERISTICS

Bussmann Part Number	Rated Current RMS-Amps	I <sub>t</sub> (A <sup>2</sup> S)		
		Pre Arcing at 500Vac	20 x I <sub>n</sub> at 500Vac	I <sub>1</sub> 120kA at 500Vac
125NH2M	125	12700	120000	220000
160NH2M	160	19800	190000	310000
200NH2M	200	29000	300000	500000
250NH2M	250	56000	510000	850000
315NH2M	315	83000	690000	1100000
400NH2M	400	160000	1200000	1900000

SIZE: 3 CLASS: aM

500Vac



### DIMENSIONAL DATA ON PAGE 33

- For the protection of motor circuits
- Partial range breaking capacity
- Rated at 500Vac to IEC 60269-2-1 (VDE 0636)
- VDE 0636 Licence Mark
- Reduced body size for ratings <400A
- Other voltage ratings available, contact Bussmann for further information

#### 1 FUSE LINK SELECTION TABLE

Rated Current	Part Number	Watts loss (W)	Breaking Capacity	Weight	Packaging
315	315NH3M	26.2	120kA @ 500V ac 50kA @ 250V dc	0.610 kg	3 pcs per Carton
400	400NH3M	33.2			
500	500NH3M	40.0			
630	630NH3M	48.0			

#### 2 FUSEHOLDER SELECTION TABLE FOR SIZE 03 (3S) & 3 FUSE LINKS

No.Poles	Part Number	Material	Max Rated Current	Max Watts Loss of Fuse Link	Weight	Packaging
1	SBS3	Steatite	630A	60W	0.870 kg	1 per box

#### 3 FUSE SWITCH-DISCONNECTOR SELECTION TABLE FOR SIZE 03 (3S) & 3 FUSE LINKS

No.Poles	Part Number	Max Rated Current of Fuse Links	Rated Voltage	Max Watts Loss of Fuse Link	Weight	Packaging
1	LBS3/1	630A	690V ac	60W	4.800 kg	1 per Box
3	LBS3/3					

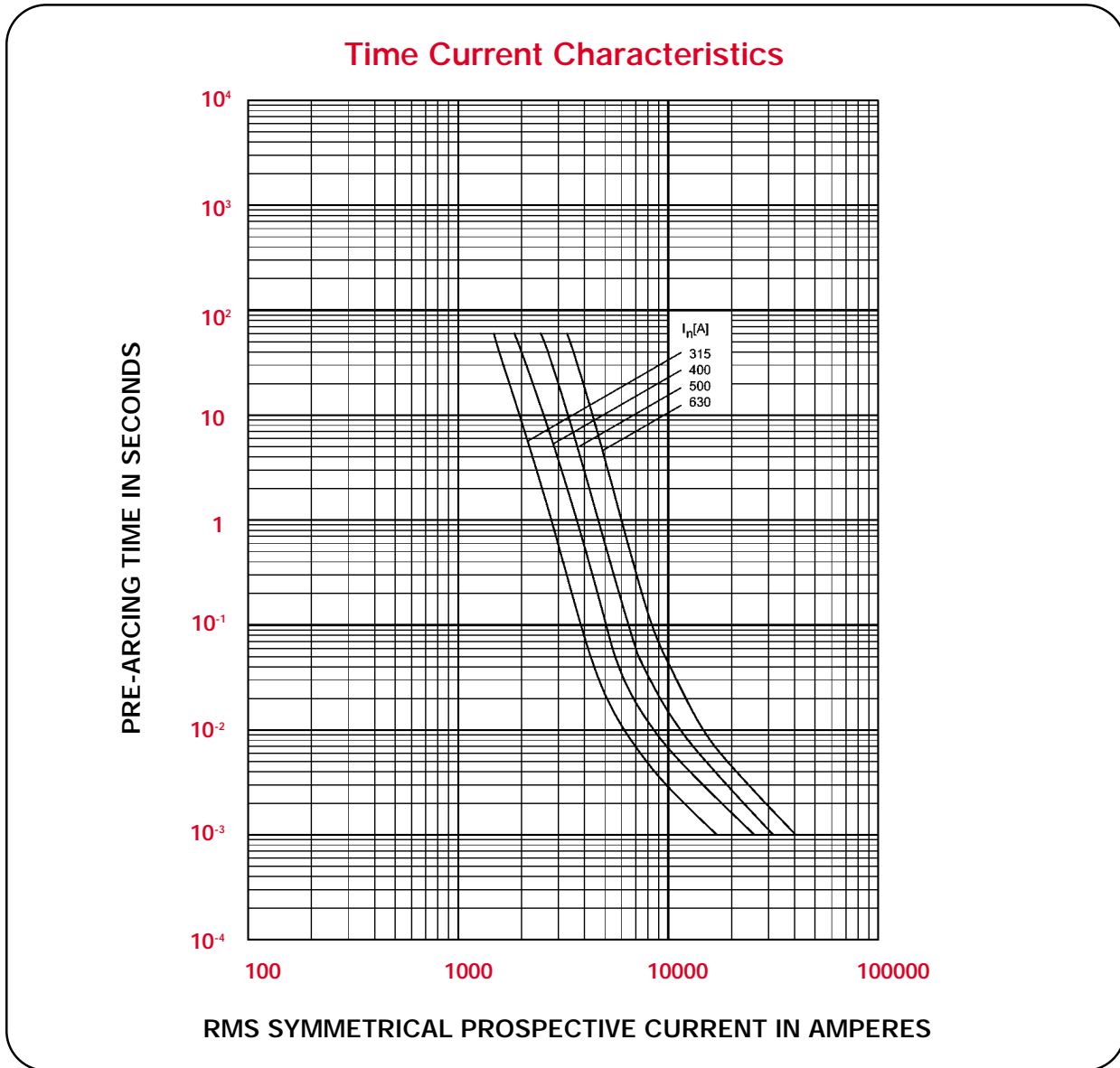

**I<sup>2</sup>t** CHARACTERISTICS

Bussmann Part Number	Rated Current RMS-Amps	I <sup>2</sup> t (A <sup>2</sup> S)		
		Pre Arcing at 500Vac	20 x I <sub>n</sub> at 500Vac	I <sub>1</sub> 120kA at 500Vac
315NH3M	315	83000	690000	1100000
400NH3M	400	160000	1200000	1900000
500NH3M	500	200000	1900000	2100000
630NH3M	630	370000	3200000	4100000

Cut-off Characteristics gG/gL 500Vac

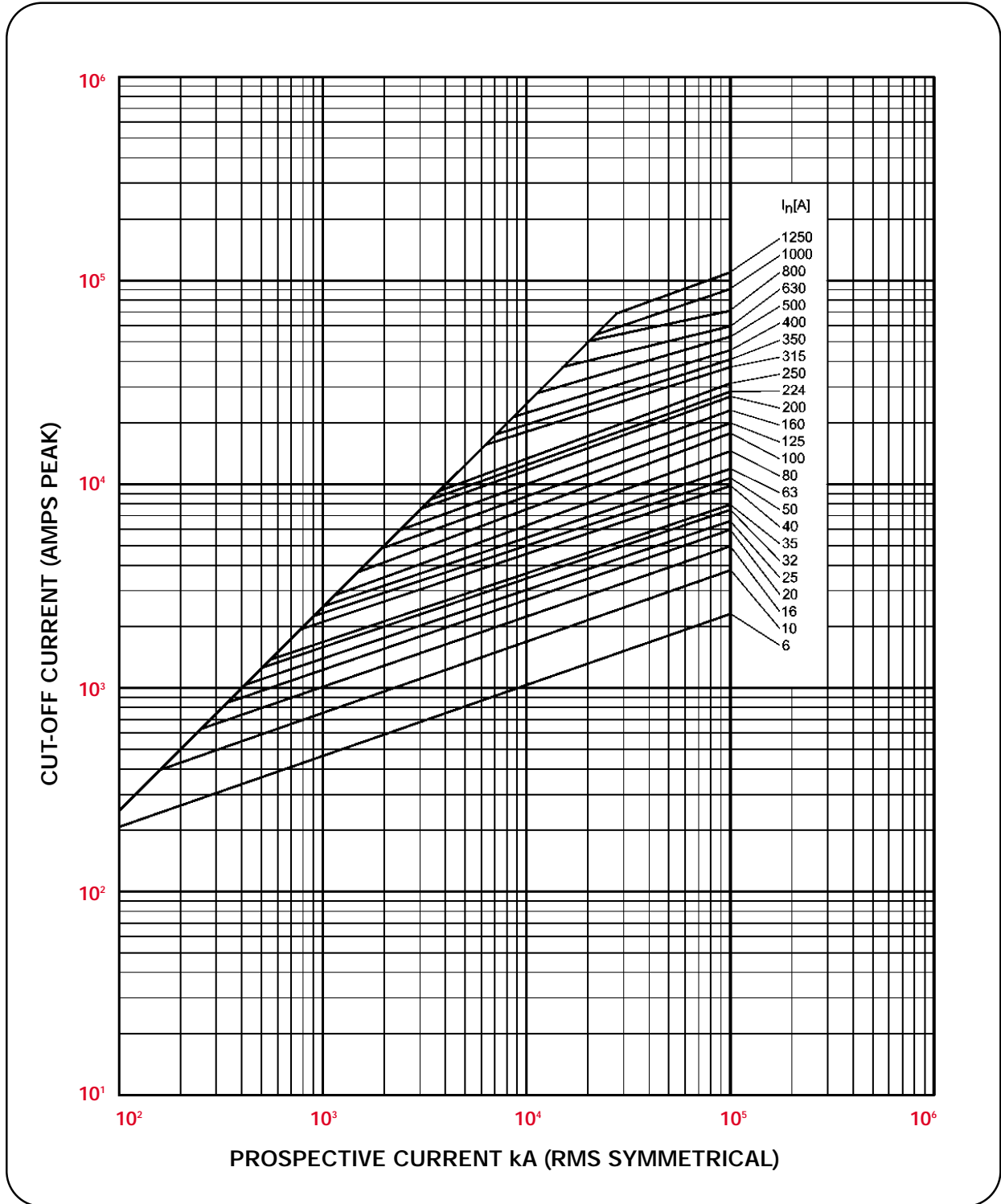



Cut-off Characteristics aM 500Vac

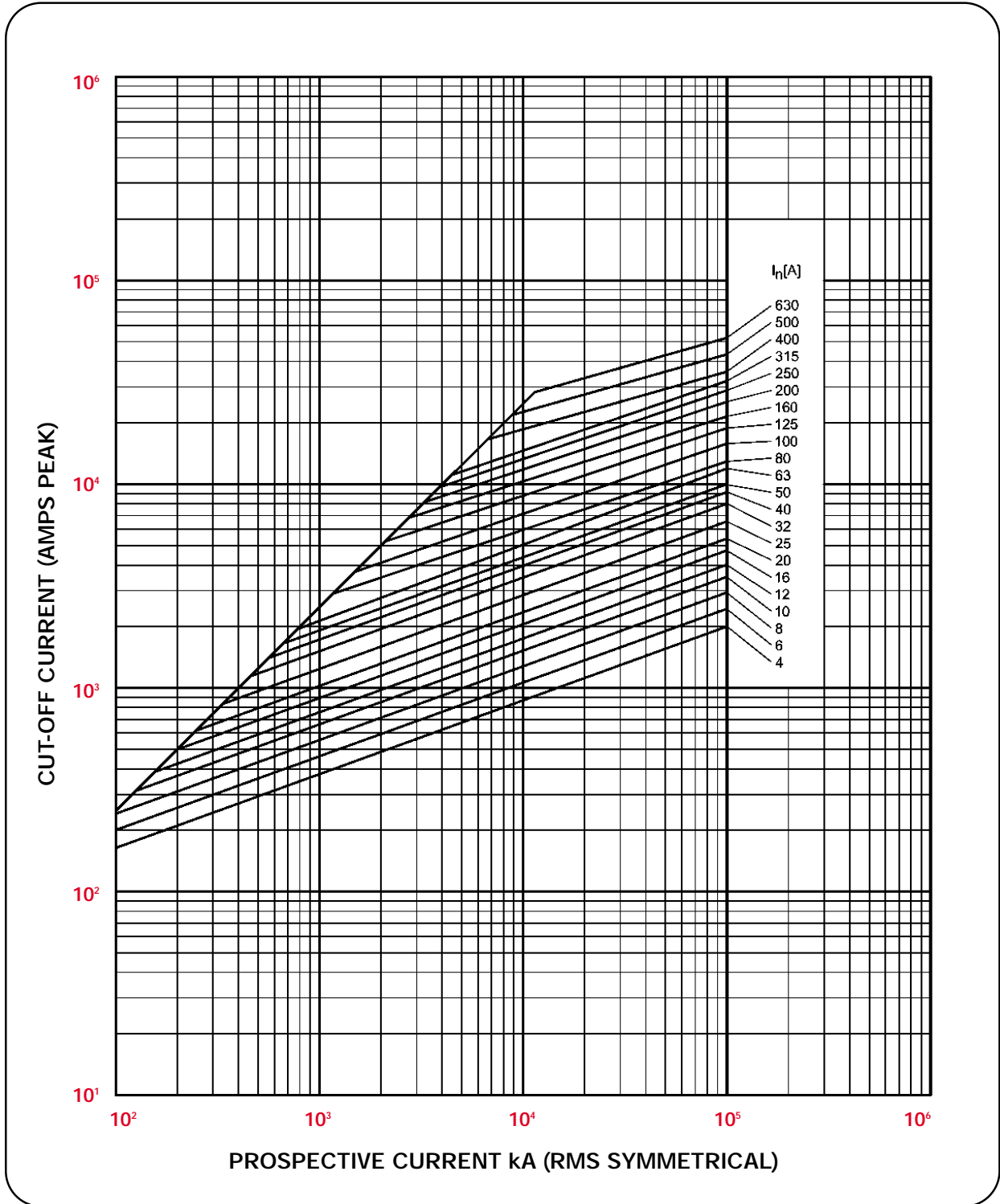

## Dimensional Data for NH Fuses

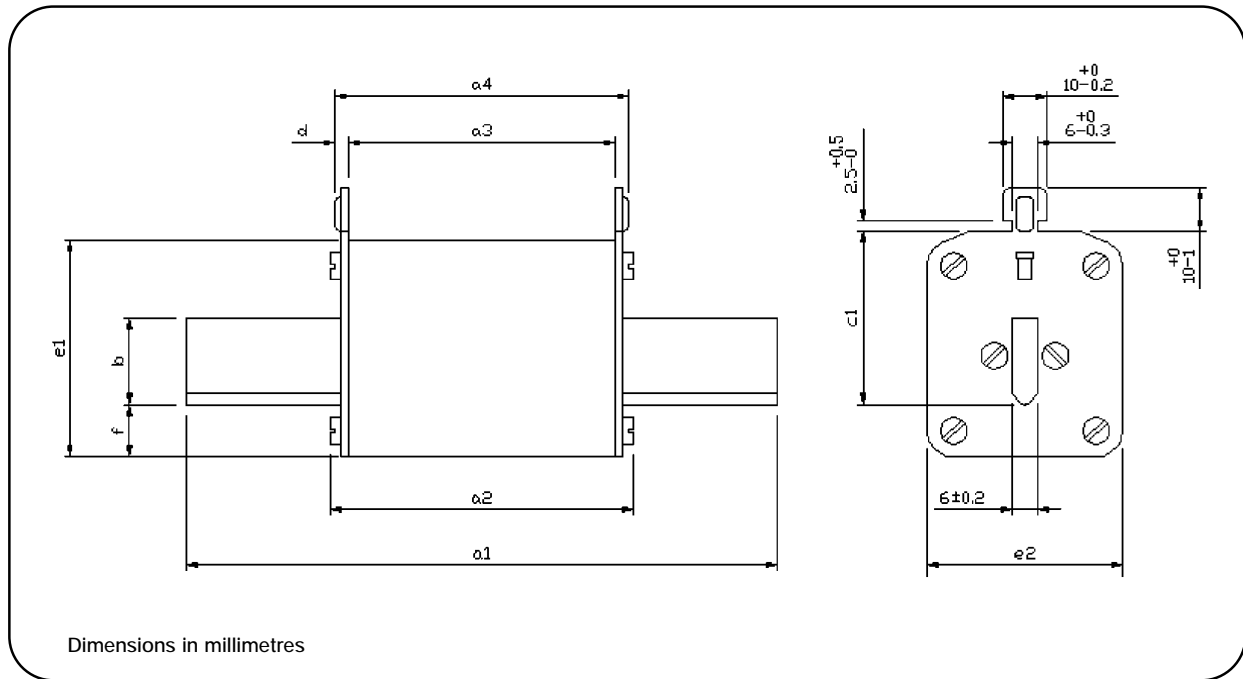

Fuse Size	$I_n$ (A)	a1	a2	a3	a4	b (min)	c1	D	e1	e2	f
C00	63	78.5	53	45.5	49	15	35	1.7	39.5	20.5	7
00	160	78.5	53	45.5	49	15	35	1.7	38	29	7
01	160	135	69	62	67	15	40	2.5	45	29	12
1	250	135	69	61	67	20	40	3	50	44.5	12
02	250	150	69	61	67	20	48	3	50	44.5	12
2	400	150	70	61	67	25	48	3	58	50	12
03	400	150	70	61	68	25	60	3	58	50	12
3	630	150	73	61	68	32	60	3	73	71	15
4a	1000	200	84	84	90	50	85	3	102	87	30
4a	1600	200	84	84	90	50	85	3	110	95	30

## NH Neutral Links

- For use with NH Fuse Switch-disconnectors and NH Fuse Bases
- Available in sizes 00 to Size 4
- Nickel plated copper

### 1 FUSE LINKS SELECTION TABLE

Rated Current	Part Number	Size	Weight	Packaging
160	SL00	00	0.090 kg	3 pcs per carton
250	SL1	1	0.170 kg	
400	SL2	2	0.230 kg	
630	SL3	3	0.290 kg	
1000	SL4	4	0.351 kg	

### Dimensions of the disconnecting knives



Dimensions in millimetres

### 2 DIMENSIONAL DATA (Millimetres)

Part Number	A	B	C	D
SL00	16	35	45	78.5
SL1	20	40	50	135
SL2	25	48	58	150
SL3	32	60	70	150
SL4	40	60	70	150

## 1 Pole Fuse Bases for NH Fuses

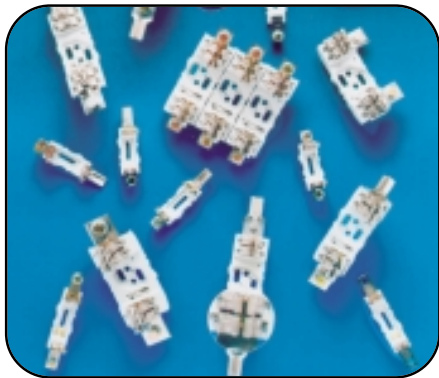

FOR TERMINATION TYPES SEE PAGE 38

- For use with size C00 to Size 2 fuse links
- Fibreglass reinforced Polyester material
- Rated at 690Vac
- Approved to IEC 60269 (VDE 0636)
- Comprehensive range of accessories are available

**1 FUSE BASE TECHNICAL DATA**

Part Number	SB00	SB1	SB2
Size of Fuse links Accommodated	C00 (000)	01 (1S) & 1	02 (2S) & 2
Rated Current	160A	250A	400A
Maximum power loss of fuse links	12W	32W	45W
Rated Voltage	690V ac		
Degree of Protection	IP 00		
Resistance to Climatic conditions	Tropical		
Weight	0.130 kg	0.360 kg	0.420 kg
Packing	3 pieces per box		

Type	Versions of terminals												
	=	MM	MP	SV	MV	VV	SW	MW	WW	L-	LS	LM	LW
SB00	X	X	X	X	X	X							
SB1	X	X					X	X	X				
SB2	X	X					X	X	X	X	X	X	X

X - means version which can be ordered      MP - means version MM with the clamp P mounted on one side

## Dimensional Data

## 1 Pole Fuse Bases for NH Fuses

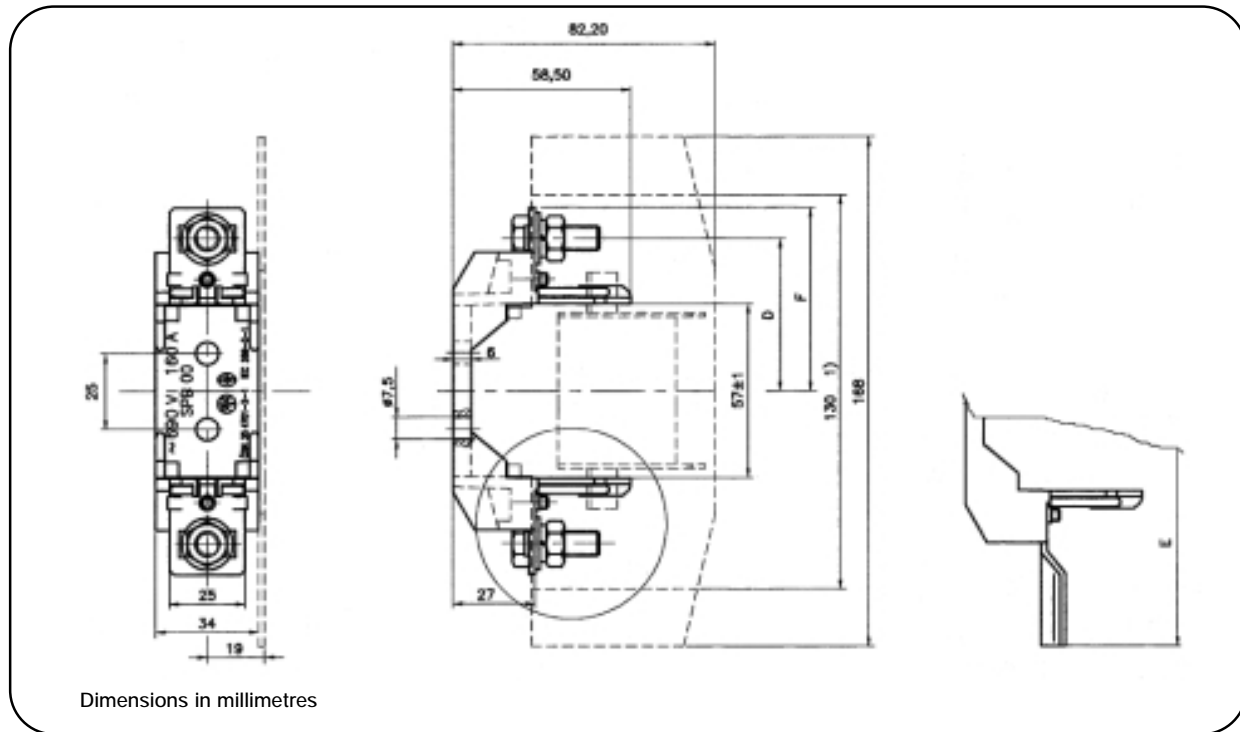

Bussmann Part Number	D	E	F
SB00	50 + 0,75		
SB00-MM		-	60,2
SB00-SV	50 + 0,75	-/80,5	60,2/-
SB00-MV	50 + 0,75	-/80,5	60,2/-
SB00-VV		80,5	-
SB00-MP	50 + 0,75	-	60,2

all dimensions in millimetres



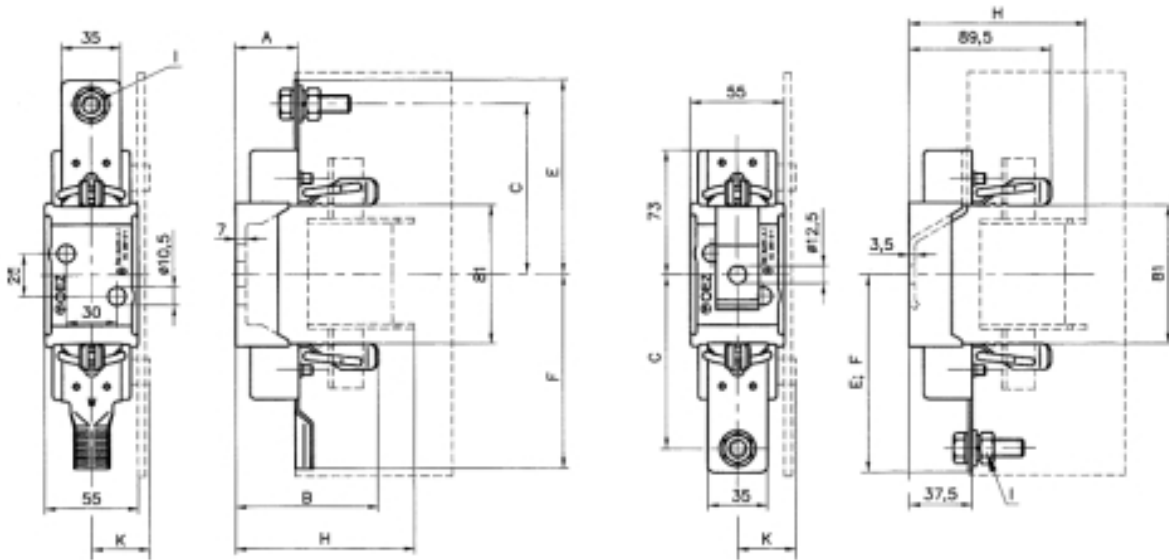

Dimensions of the fuse bases SPB1 and SB2



Dimensions in millimetres

Bussmann Part Number	A	B	C	E	F	H	I	K
SB1	37	83.5	87.5	100.5	-	108	M10	31
SB1-MM	37	83.5	87.5	100.5	-	108	M10	31
SB1-WW	37	83.5	-	-	110.5	108	-	31
SB1-SW	37	83.5	87.5	100.5	110.5	108	M10/-	31
SB1-MW	37	83.5	87.5	100.5	110.5	108	M10/-	31
SB2	37.5	89.5	100	114	-	116	M10	36
SB2-MM	37.5	89.5	100	114	-	116	M10	36
SB2-WW	37.5	89.5	-	-	114	116	-	36
SB2-SW	37.5	89.5	100	114	114	116	M10/-	36
SB2-MW	37.5	89.5	100	114	114	116	M10/-	36
SB2-LM	-	-	100	114	-	116	M10	38
SB2-LW	-	-	-	-	114	116	-	38

all dimensions in millimetres

	Marking	Description of terminals
	NO SUFFIX STANDARD TERMINATION	Flat screw terminal: size 00 equipped with screw M8 and pad sizes 1, 2 and 3 - equipped with screw M10 and pad
	M	Flat screw terminal with pressed nut from bottom side and screw, size 00 M8; sizes 1, 2 and 3 M10
	P	Terminal with clamp for solid and stranded conductors 1 to 50 mm <sup>2</sup> . Cu and solid conductors 2,5 to 50 mm <sup>2</sup> Al. Two conductors are possible for SB00, SBS00, TB00
	V	"V-" shaped terminal for clamps type 4836N, 4836N-S and 5836 for size of fuse bases 00
	W	"V-" shaped terminal for clamps type 4835N-240 and 5837 for size of fuse bases 1 and 2

## 1 Pole Fuse Bases for NH Fuses

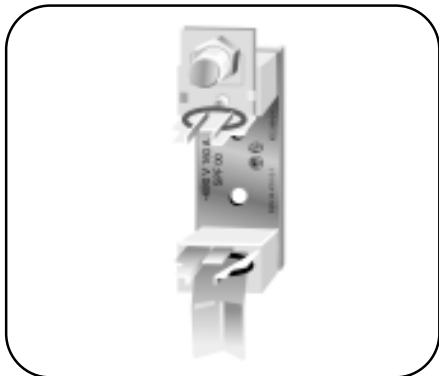

FOR TERMINATION TYPES SEE PAGE 38

- For use with size C00 to Size 3 fuse links
- Steatite material
- Rated at 690Vac
- Approved to IEC 60269 (VDE 0636)
- Comprehensive range of accessories are available

**1 FUSE BASE TECHNICAL DATA**

Part Number	SBS00	SBS1	SBS2	SBS3
Size of Fuse links Accommodated	C00 (000)	01 (1S) & 1	02 (2S) & 2	03 (3S) & 3
Rated Current	160A	250A	400A	630A
Maximum power loss of fuse links	12W	32W	45W	60W
Rated Voltage	690V ac			
Degree of Protection	IP 00			
Resistance to Climatic conditions	Normal and Tropical			
Weight	0.280 kg	0.700 kg	0.810 kg	0.870 kg
Packing	3 pieces per box			



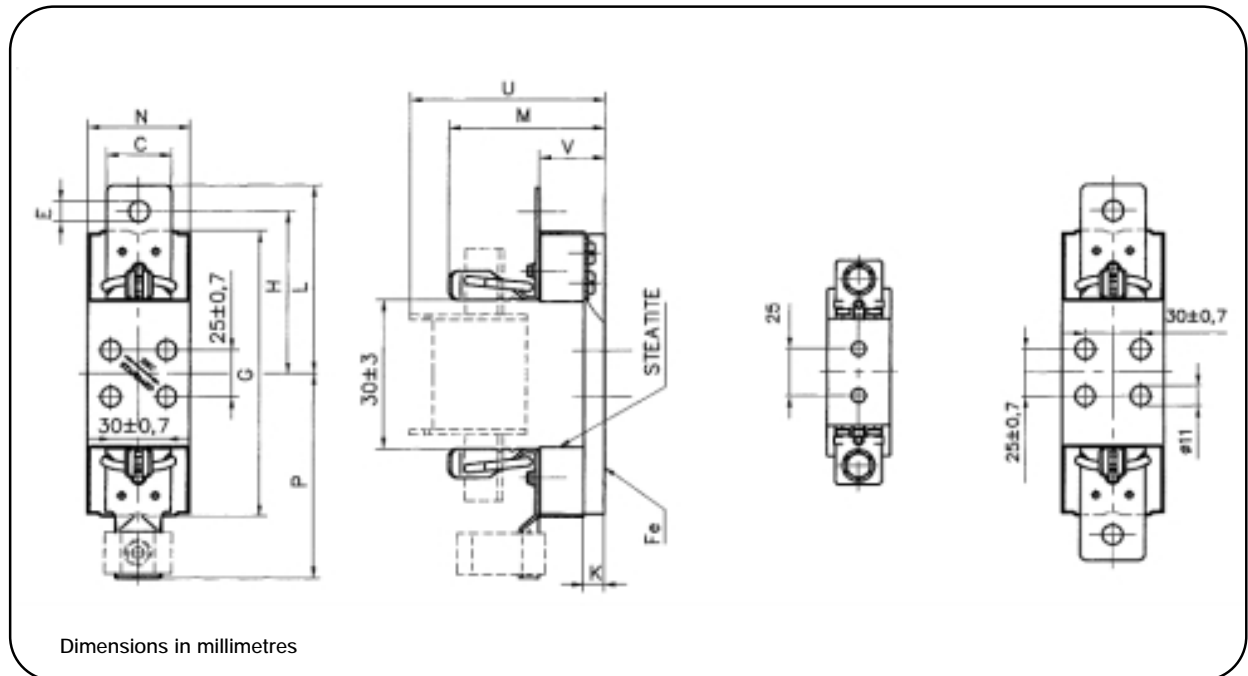

Bussmann Part Number	C	E	G	H	K	L	M	N	P	U	V
SBS00	25	M8	90	50	5,5	60,2	58,5	34	-	84	25
SBS00-MV	25/-	M8/-	90	50/-	5,5	60,2/-	58,5	34	-/80,5	84	25
SBS00-VV	-	-	90	-	5,5	-	58,5	34	80,5	84	25
SBS-1	35	M10	153	87,5	11	100	84	55	-	108	35
SBS1-MM	35	M10	153	87,5	11	100	84	55	-	108	35
SBS1-WW	-	-	153	-	11	-	84	55	110	108	35
SBS1-SW	35/-	M10/-	153	87,5/-	11	100/-	84	55	-/110	108	35
SBS1-MW	35/-	M10/-	153	87,5/-	11	100/-	84	55	-/110	108	35
SBS2	35	M10	153	100	11	114	90	55	-	116	35
SBS2-MM	35	M10	153	100	11	114	90	55	-	116	35
SBS2-WW	-	-	153	-	11	-	90	55	114	116	35
SBS2-SW	35/-	M10/-	153	100/-	11	114/-	90	55	-/114	116	35
SBS2-MW	35/-	M10/-	153	100/-	11	114/-	90	55	-/114	116	35
SBS3	40	M10	153	105	11	119	92	55	-	122	35
SBS3-MM	40	M10	153	105	11	119	92	55	-	122	35

all dimensions in millimetres

### 3 Pole Fuse Bases for NH Fuses

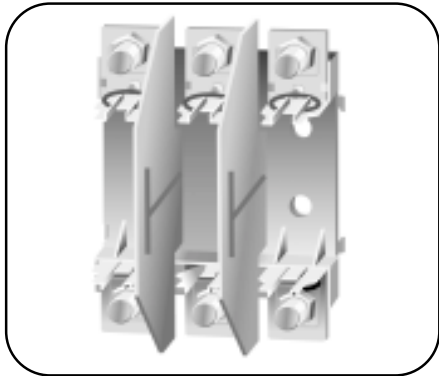

FOR TERMINATION TYPES SEE PAGE 38

- For use with size C00 to Size 2 fuse links
- Fibreglass reinforced Polyester material
- Rated at 690Vac to IEC 60269 (VDE 0636)
- 3 Pole Fuse bases for Size 3 & 4 fuse links are available.
- Contact Bussmann for further information

**1 FUSE BASE TECHNICAL DATA**

Part Number	TB00	TB1	TB2
Size of Fuse links Accommodated	C00 (000)	01 (1S) & 1	02 (2S) & 2
Rated Current	160A	250A	400A
Maximum power loss of fuse links	12W	32W	45W
Rated Voltage	690V ac		
Degree of Protection	IP 00		
Resistance to Climatic conditions	Tropical		
Weight	0.500 kg	1.200 kg	1.400 kg
Packing	1 piece per box		

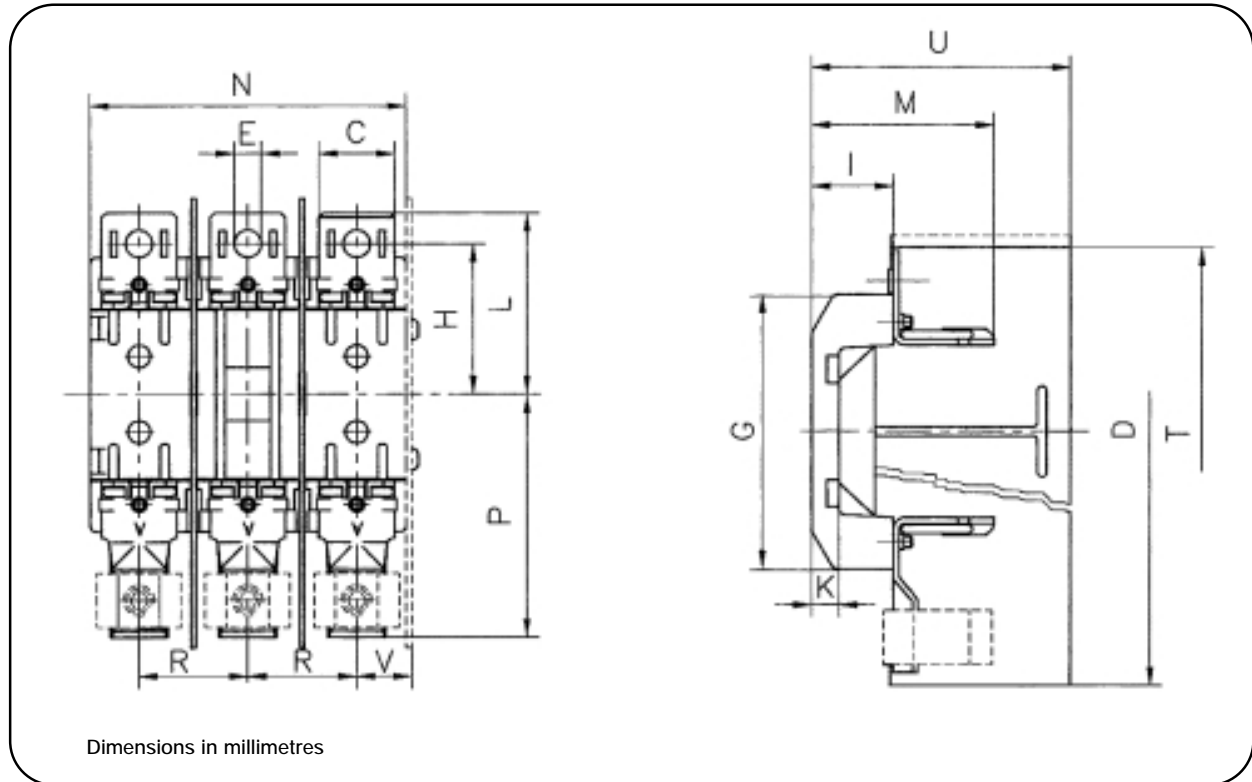

Bussmann Part Number	C	D	E	G	H	I	K	L	M	N	P	R	T	U	V
TB00	25	-	M8	104	50	25	9	60	58,5	105	-	36	130	86	19
TB00-SV	25/-	168	M8/-	104	50/-	25	9	60/-	58,5	105	-/80,5	36	-	86	19
TB00-VV	-	168	-	104	-	25	9	-	58,5	105	80,5	36	-	86	19
TB1	35	-	M10	146	87,5	35	7	100	84	159	-	56	205	108	31
TB1-MM	35	-	M10	146	87,5	35	7	100	84	159	-	56	205	108	31
TB1-WW	-	-	-	146	-	35	7	-	84	159	110	56	-	108	31
TB1-SW	35/-	230	M10/-	146	87,5/-	35	7	100/-	84	159	-/110	56	-	108	31
TB1-MW	35/-	230	M10/-	146	87,5/-	35	7	100/-	84	159	-/110	56	-	108	31
TB2	35	230	M10	146	100	35	7	114	90	179	-	66	230	116	36
TB2-MM	35	-	M10	146	100	35	7	114	90	179	-	66	230	116	36
TB2-WW	-	-	-	146	-	35	7	-	90	179	114	66	-	116	36
TB2-SW	35/-	230	M10/-	146	100/-	35	7	114/-	90	179	-/114	66	-	116	36
TB2-MW	35/-	230	M10/-	146	100/-	35	7	114/-	90	179	-/114	66	-	116	36

all dimensions in millimetres

## Fuse Extraction Handle

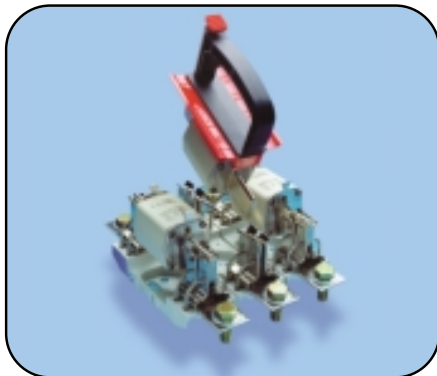

- For use with size C00 to Size 3 fuse links
- Rated at 690Vac

**1 FUSE EXTRACTION HANDLE TECHNICAL DATA**

Part Number	FEH	FEH-IB	FEH-S
	Basic Handle	With Insulated Barriers	Sleeved
Size of Fuse links to be used with	C00, 00, 0, 01, 1, 02, 2, 03, 3		
Insulating Voltage	690Vac		
Resistance to Climatic Conditions	Normal and Tropical		
Weight	0.220 kg	0.520 kg	0.520 kg
Packaging	1 piece per carton		

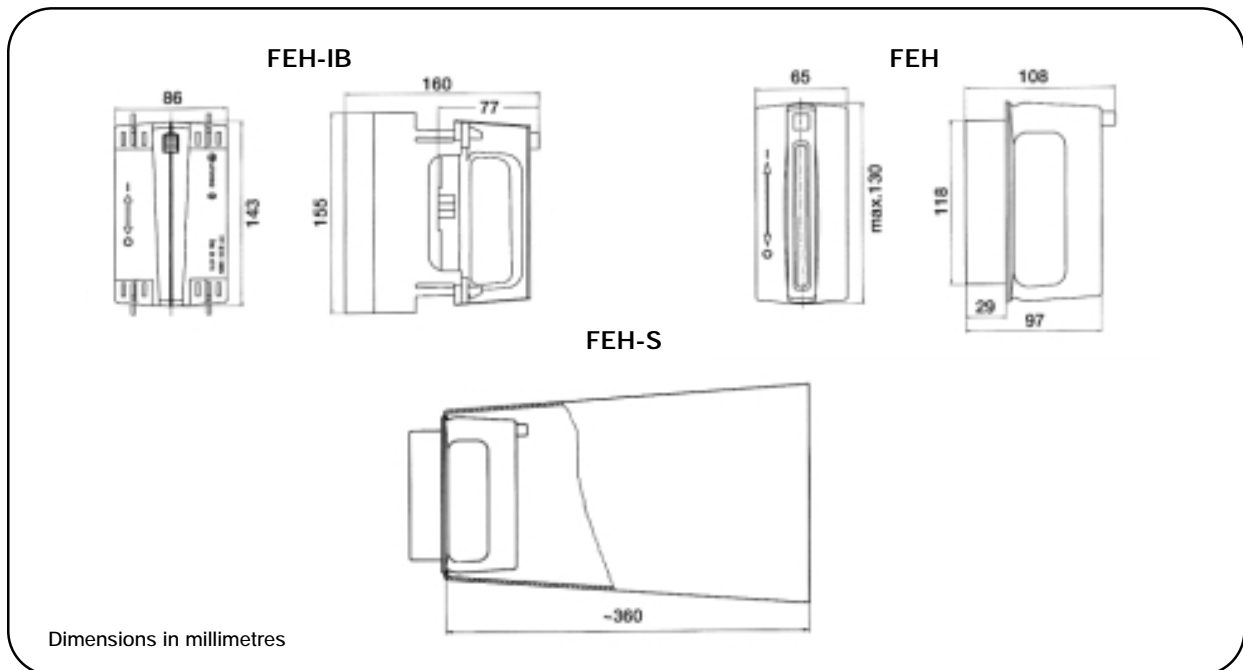

END BARRIERS

- Material: fibreglass
- Resistant to tropical climate
- End barriers weight
- All 3 pole fuses bases come with partition barriers for either side of the middle phase

1 FUSE BASE TECHNICAL DATA

End Partition Part Number	Fuse Base	Weight (kg)
EPB00	for TB00	0,022 kg
EPB1	for TB1	0,056 kg
EPB2	for TB2	0,068 kg

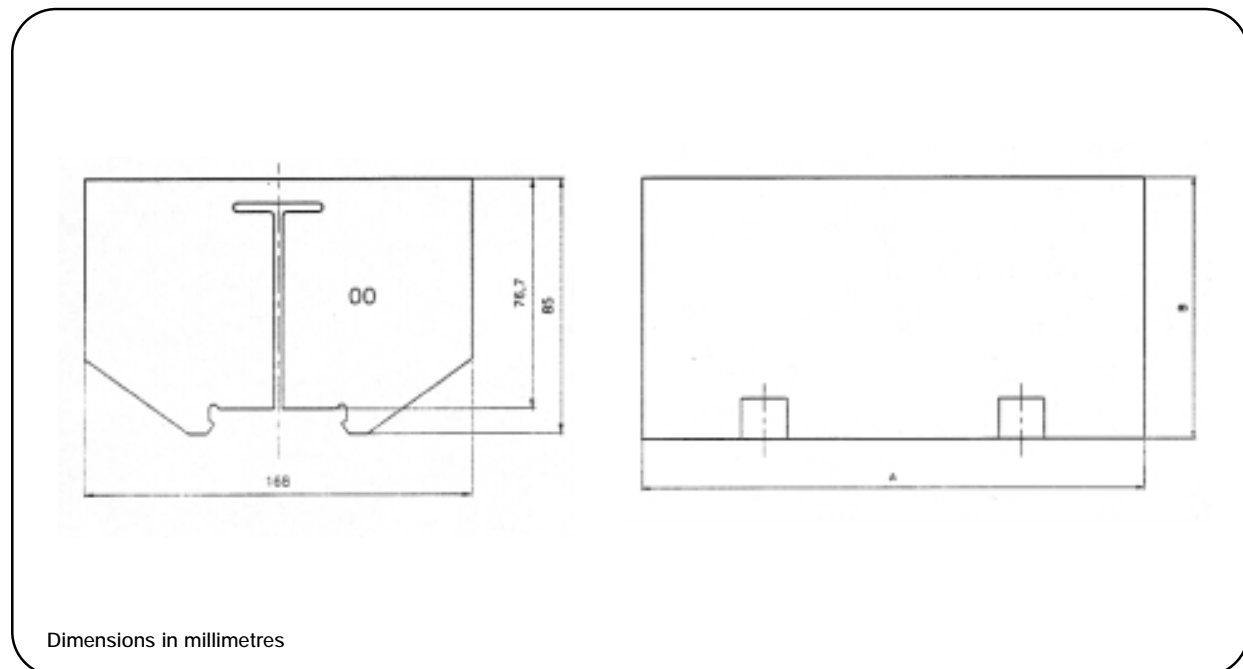

### 3 Pole Fuse Rail for NH Fuses

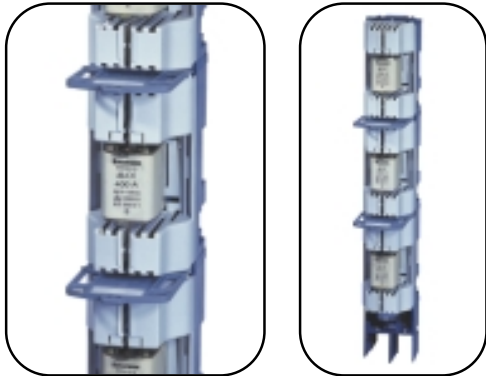

DIMENSIONAL DATA ON PAGES 46 & 47

- For use with size C00 to Size 3 fuse links
- Fully shrouded 3 pole contacts
- Rated at 690Vac
- Comprehensive range of accessories
- Contact Bussmann for part number information

**1 FUSE RAIL TECHNICAL DATA**

Part Number	BFR00 Series	BFR1 Series	BFR2 Series	BFR3 Series
Size of Fuse links Accommodated	C00 (000)	01 (1S) & 1	02 (2S) & 2	03 (3S) & 3
Rated Current	160A	250A	400A	630A
Maximum power loss of fuse links	12W	32W	45W	60W
Rated Voltage	690V ac			

Dimensional Sketches

3 Pole Fuse Rail

- Contact Bussmann for further information

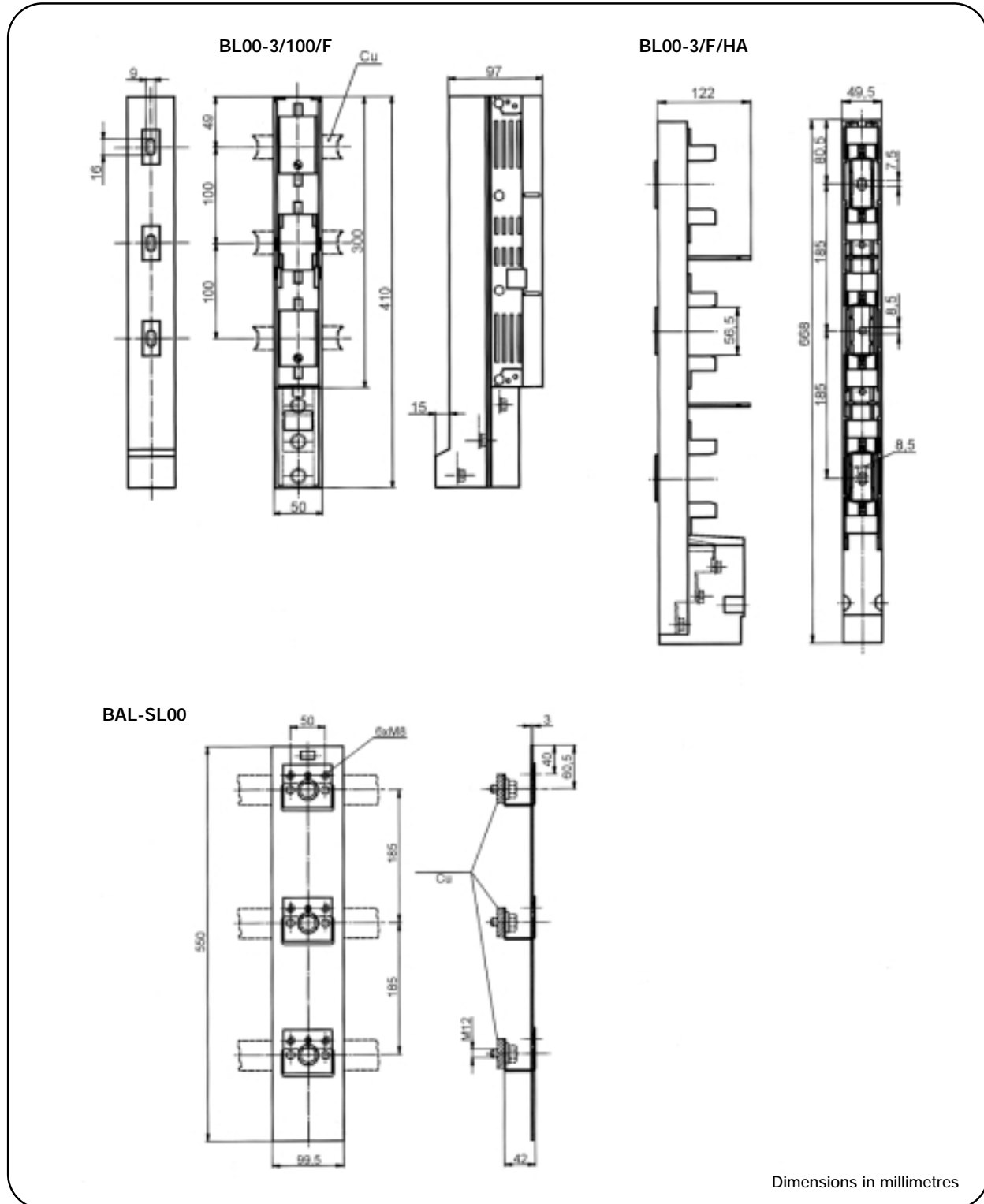





## Horizontal Fuse Switch - Disconnectors



DIMENSIONAL DATA ON PAGES 49 & 56

- For use with size C00 to Size 3 fuse links
- Rated at 690Vac
- Comprehensive range of accessories

**1** FUSE BASE TECHNICAL DATA

Part Number	LBS00	LBS1	LBS2	LBS3	LBS4a
Size of Fuse links Accommodated	C00 (000)	01 (1S) & 1	02 (2S) & 2	03 (3S) & 3	4a
Number of Poles Available	1,2,3,& 4	1,2,3,& 4	3	1,2,3,& 4	1 & 3
Maximum power loss of fuse links	12W	23W	34W	48W	110W
Rated Current	160A	250A	400A	630A	1250A
Rated Voltage	690V ac				
Conditional Short-circuit Current	50 kA				
Utilisation Category	AC22B	AC22B	AC22B	-	AC21
Rated Making Capacity @ 690Vac	480A	750A	1200A	1500A	1875A
Mechanical Durability (cycles)	1700	1400	800	800	1000
Weight	0.720 kg	2.500 kg	3.100 kg	4.800 kg	16.800 kg
Degree of Protection	IP 20				
Permissible Ambient Temperature	-25°C to +55°C				
Altitude Limit (metres)	Up to 2000m				Up to 3000m
Overvoltage Category	AC III	AC III	AC III	AC III	AC III
Seismic Withstand Capability	3g / 8 to 50Hz				-

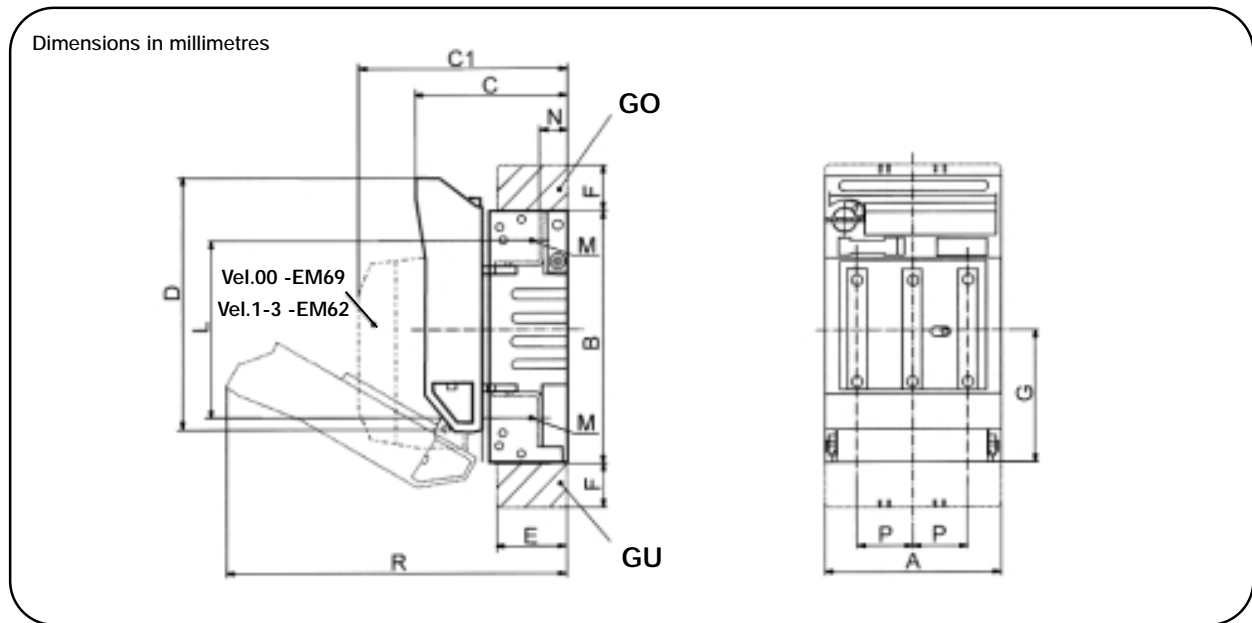

Type	A mm	B mm	C mm	C1 mm	D mm	E mm	F mm	G mm	R mm	L mm	N mm	M mm	P mm
LBS00	105,5	149	90	132	151	43	25	79	196	120	17	M8	33
LBS1	184	230	120	158	216	64	44	110	295	177	24	M10	58
LBS2	210	256	135	171	241	79	70	128	335	205	24	M10	66
LBS3	254	270	145	185	241	93,5	93,5	138	348	219,5	30,5	M10	82

all dimensions in millimetres

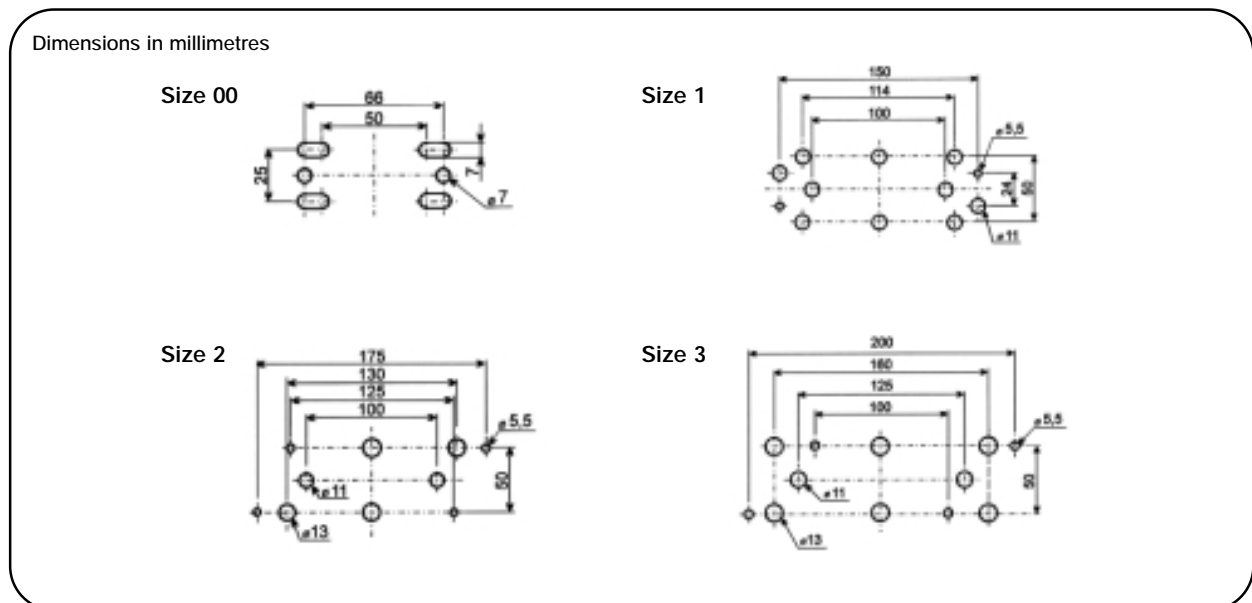

Fuse switch-disconnector LBS00 with adapter for busbar systems

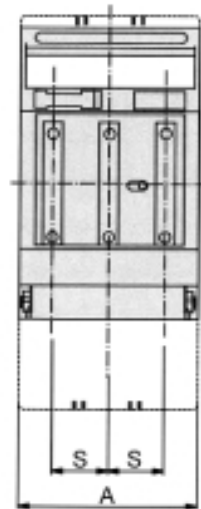
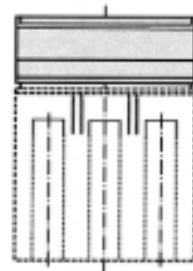
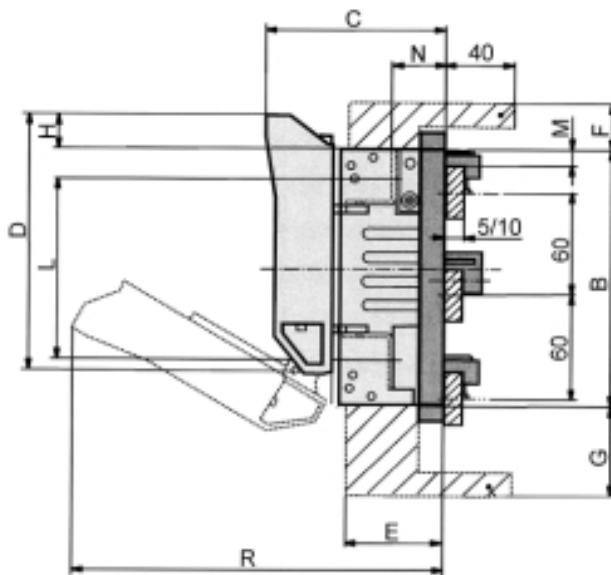

Dimensions in millimetres

Type	A mm	B mm	C mm	C1 mm	D mm	E mm	F mm	G mm	H mm	L mm	N mm	M mm	R mm	S mm
LBS00+AL06030/..	105,5	149	102	135	151	58	27,5	53	21	120	10	32	215	33
LBS1+AL16030/..	184	230	138	173	220	79	44	44	17	177	50	39,5	312	58

all dimensions in millimetres

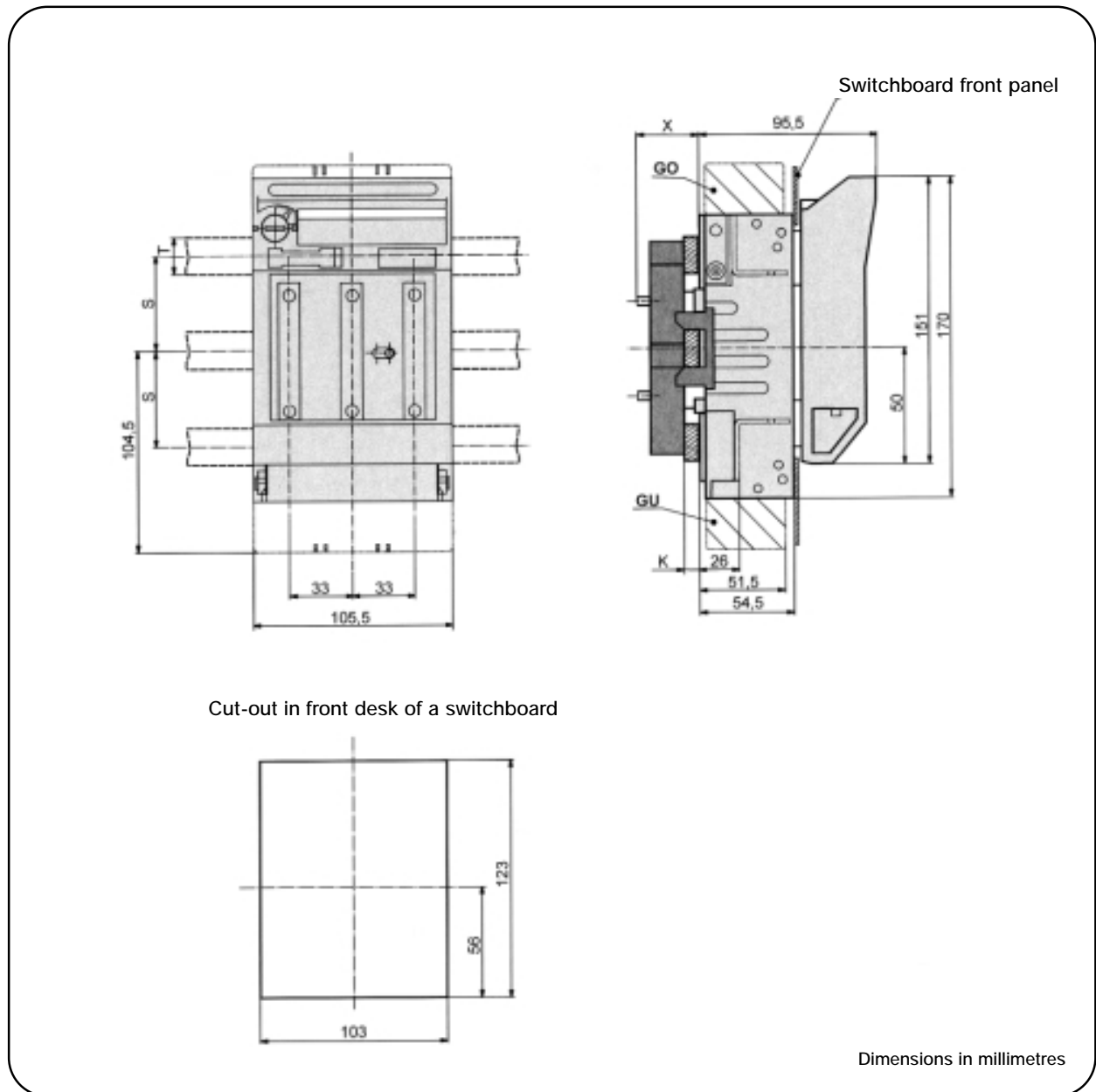

Type	S mm	T mm	K mm	X mm
LBS00-3/9/4012/..	40	12	5-10	26
LBS00-3/9/5020/..	50	20	5-15	33
LBS00-3/9/6030/..	60	30	5-10	26

Dimensions in millimetres

### LBS00 1 Pole and 2 Pole

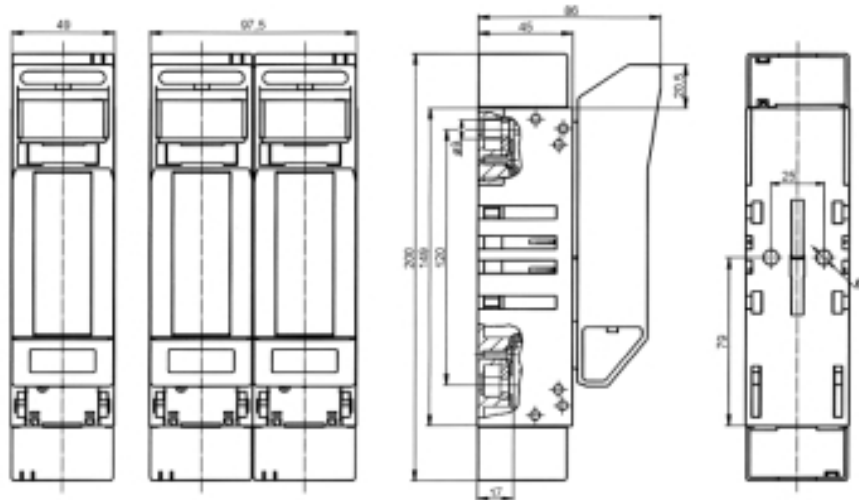

### LBS00 3 Pole

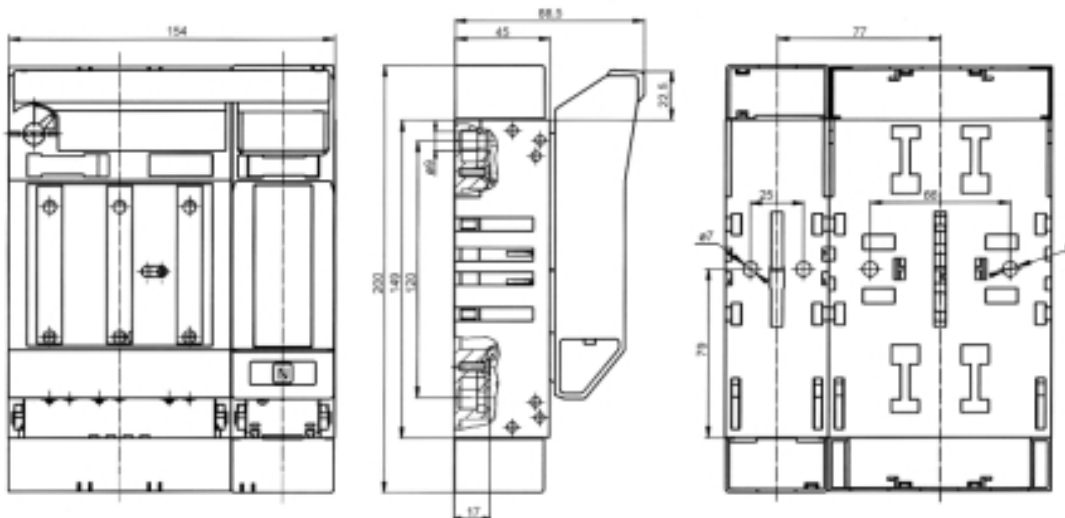

Number of poles		A mm	B mm	C mm	D mm	E mm	F mm	G mm	H mm	I mm	K mm	L mm	M mm	N mm	O mm	P mm	R mm	S mm	T mm	U mm	V mm	W mm	X mm	
1	LBS1-1/9/U	69	-	-	-	119	-	-	-	-	-	-	-	-	-	-	-	-	-	-	-	-	-	-
2	LBS1-2/9/U	138	230	317	68	123,5	102,5	102,5	25	30	10,5	10,5	177	25	69	-	-	-	-	-	-	-	-	-
4	LBS1-4/9/U	252,5	-	-	-	123,5	-	-	-	-	-	-	-	-	150	100	114	25	50	11	5,5	126	11	-
1	LBS3-1/9/U	91	-	-	-	147	-	-	-	-	-	-	-	-	-	-	-	-	-	-	-	-	-	-
2	LBS3-1/9/U	182	270	431	96	151,5	122,5	122,5	25	30	10,5	10,5	220,5	30,5	91	-	-	-	-	-	-	-	-	-
4	LBS3-1/9/U	347	-	-	-	153,5	-	-	-	-	-	-	-	-	200	125	160	25	50	13	5,5	173,5	11	

Fuse switch-disconnector LBS4a

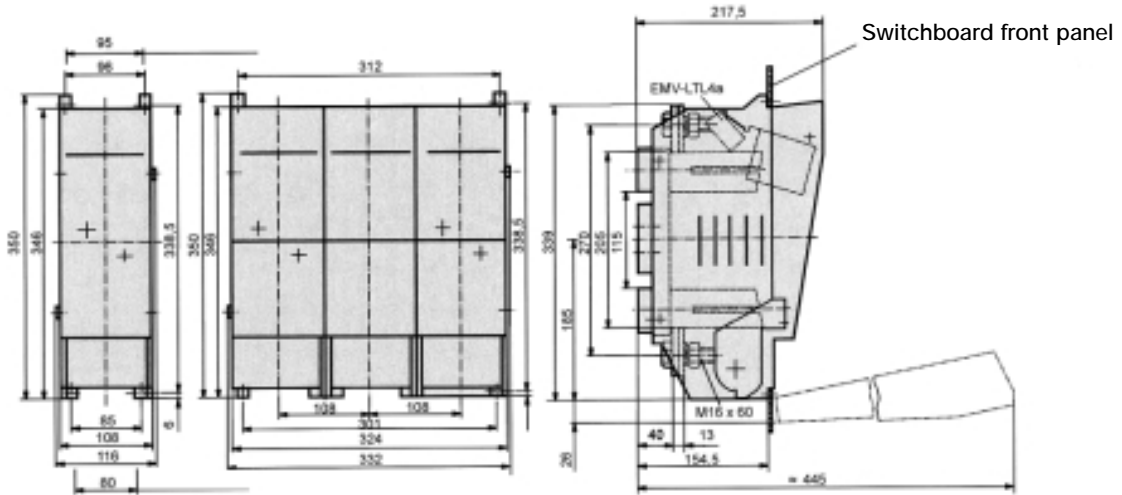

Fixing holes

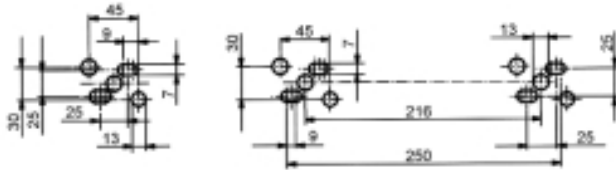

LBS4a-3x and LBS4a-3x3 have the same dimensions

Panel apertures

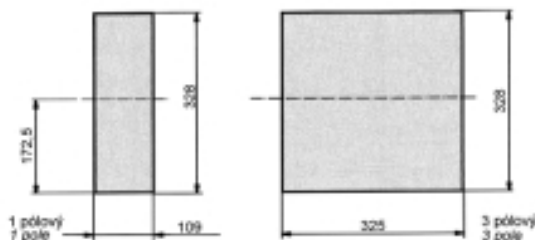

Terminals

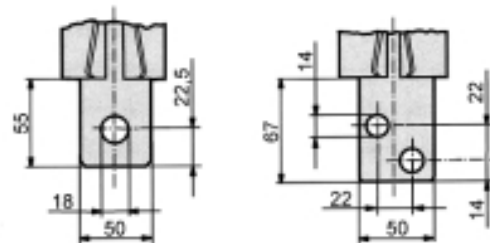

Dimensions in millimetres

## Dimensional Sketches

## Fuse Bases for NH Fuse Links

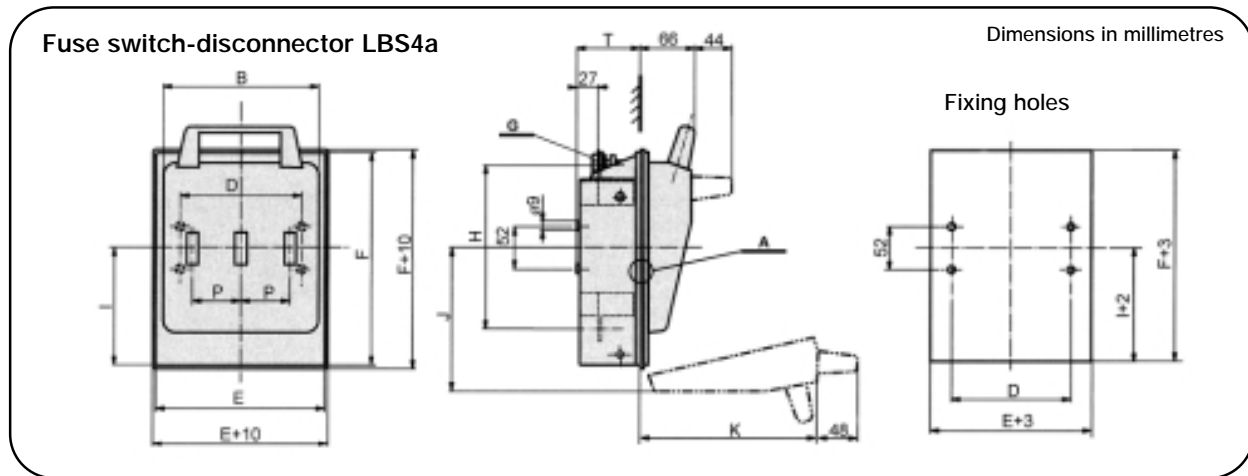

Type	Rated Current	mm	B mm	D mm	E mm	F mm	H mm	I mm	J mm	K mm	M mm	N mm	P mm	TG mm
LBS4a	250 A	194	150	200	260	186	175	M10	220	142	126	60	82	M10
LBS4a	400 A	254	174	260	290	214	195	M12	254	162	135	60	86	M12
LBS4a	630 A	254	174	260	290	224	195	M12	254	162	135	60	93	M12

all dimensions in millimetres

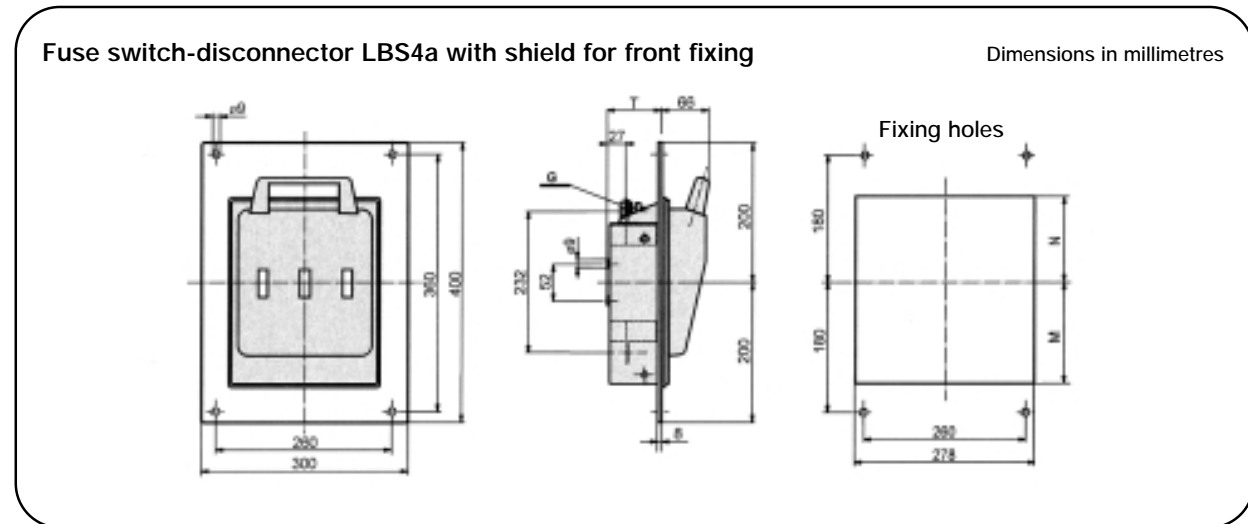

### Fuse switch-disconnector LBS4a with auxiliary switch DS

Size	1ST4	2ST4	3ST4
A	128	159	159

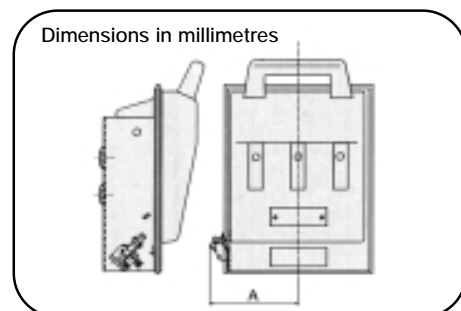

Dimensions in millimetres

Size 00

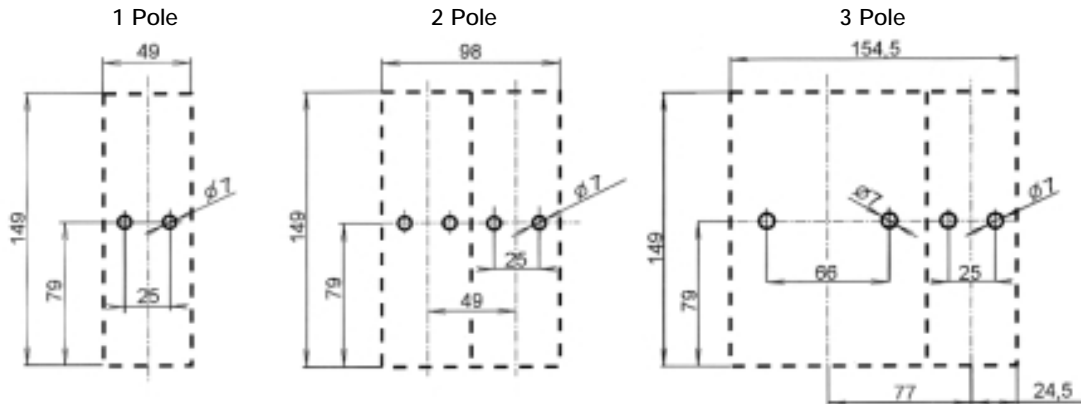

Size 1

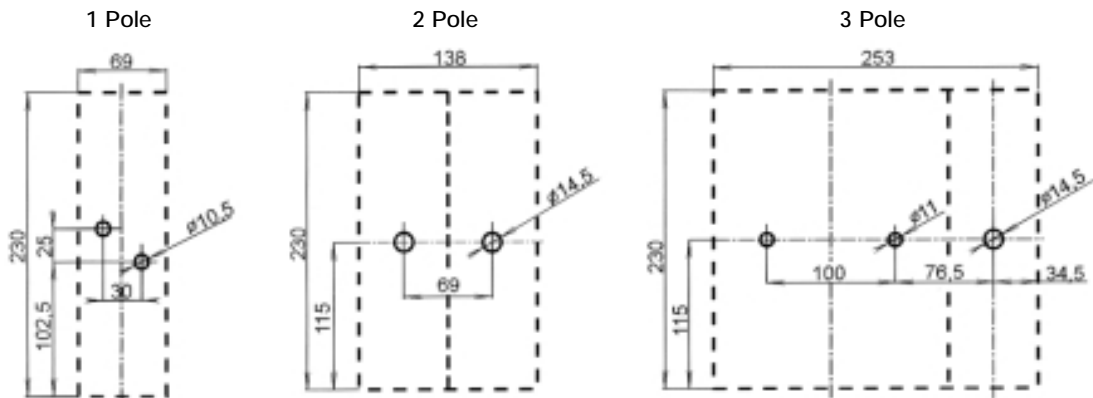

Size 3

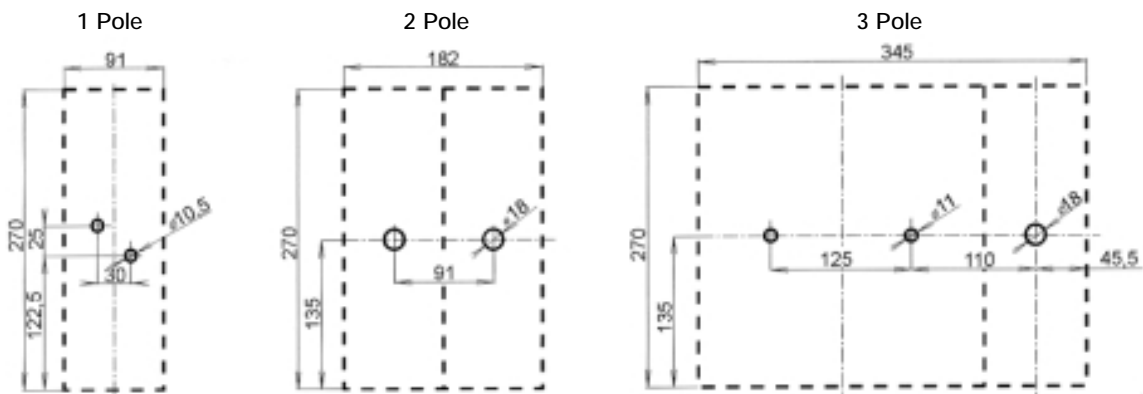



Fuse switch-disconnector LBS2 with adapter for busbar systems

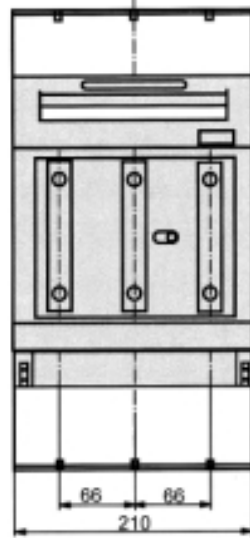
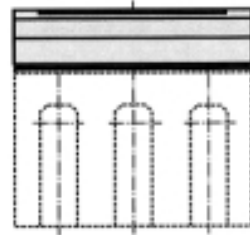
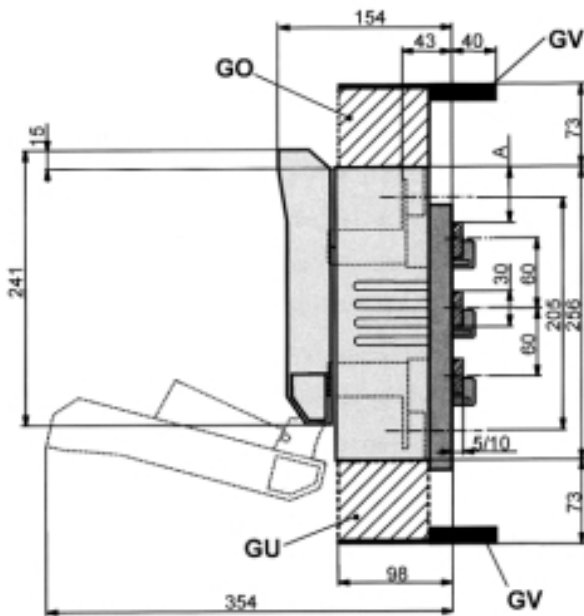

Dimensions in millimetres

Type	A
Cable outlet at the bottom	60
Cable outlet at the top	48

## Vertical Fuse Switch - Disconnectors



- For use with size C00 to Size 3 fuse links
- Rated at 690Vac
- Fully Shrouded
- Comprehensive range of accessories
- Contact Bussmann for further information

### 1 FUSE SWITCH-DISCONNECTOR TECHNICAL DATA

Part Number	BLOO Series	BFD1 Series	BFD2 Series	BFD3 Series
Size of Fuse links Accommodated	C00 & 00	01 (1S) & 1	02 (2S) & 2	03 (3S) & 3
Number of Poles Available	3 Pole ONLY			
Maximum power loss of fuse links	12W	23W	34W	48W
Rated Current	160A	250A	400A	630A
Rated Voltage	690V ac			
Conditional Short-circuit Current	50 kA			
Utilisation Category	AC22B	AC22B	AC22B	AC22B
Mechanical Durability (cycles)	1700	1400	800	800
Weight	1.400 kg	5.500 kg	5.500 kg	6.000 kg
Degree of Protection	IP 20			
Permissible Ambient Temperature	-25°C to +55°C			
Altitude Limit (metres)	Up to 2000m			
Overvoltage Category	AC III	AC III	AC III	AC III
Seismic Withstand Capability	1.5g / 8 to 50Hz			

Dimensional Sketches

**Vertical Fuse Switch - Disconnectors**

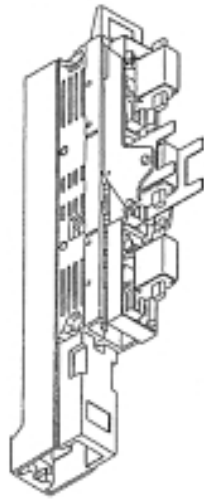

Visible circuit disconnection by disconnector is indicated by parked position

Dimensions in millimetres

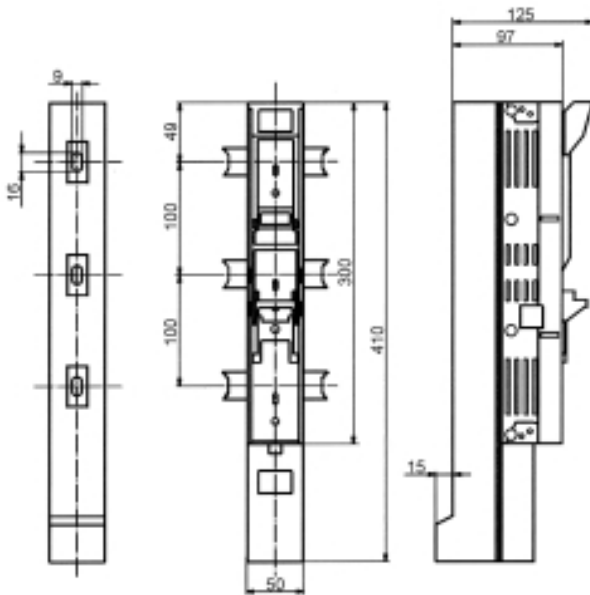

Standard delivery:  
- switch-disconnector is equipped with terminal screws M8 F00/3 on the cable outlet

Dimensions in millimetres

Type	$I_n$ A	Control	Outgoing Terminals
VLB00 Series	160	3-pole	terminal screws M8F00/3

BFD1..., BFD3..., BFD3...

1 POLE SWITCHABLE

3 POLE SWITCHABLE

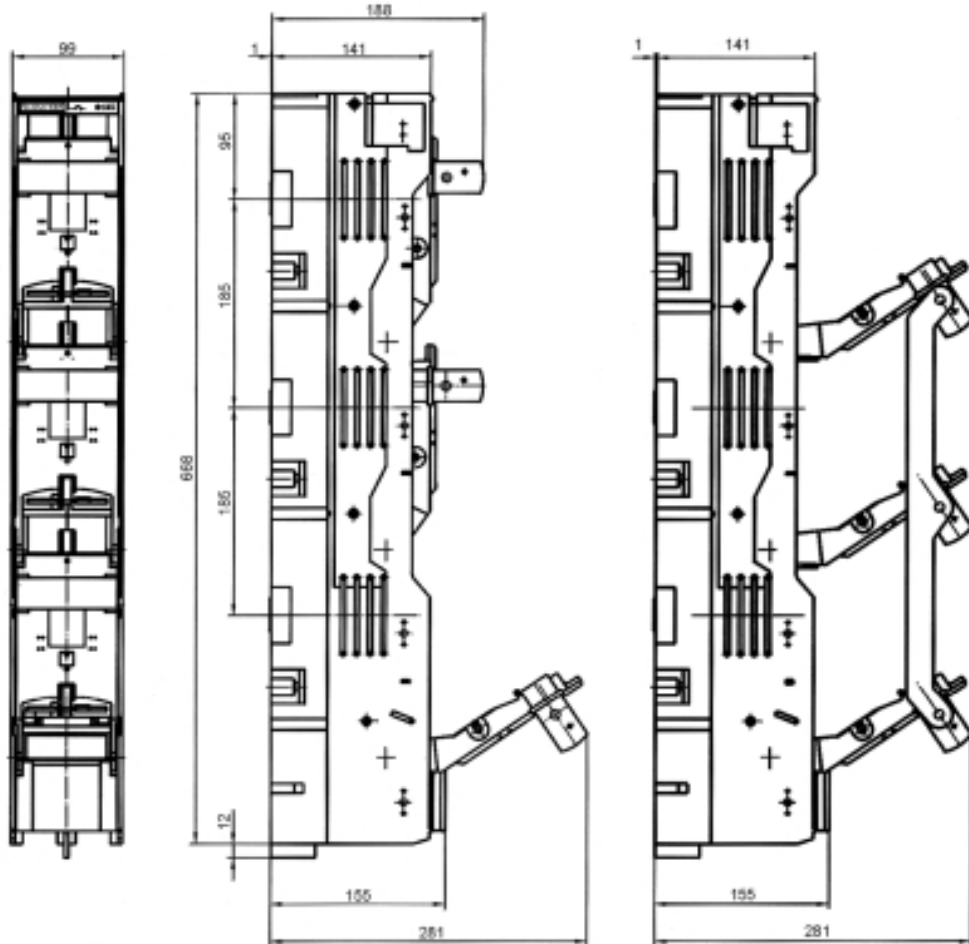

Dimensions in millimetres

**VLB00 SERIES**  
3 pole switchable

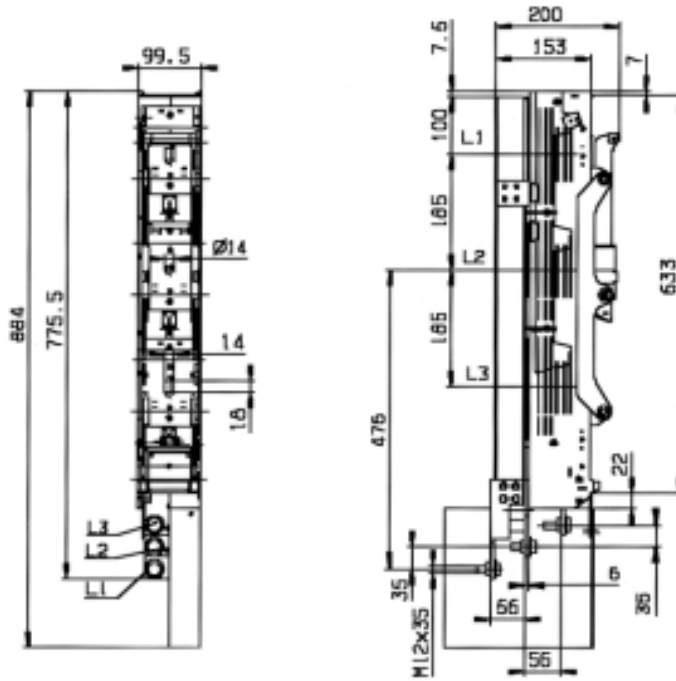

**VLB00 SERIES**  
1 pole switchable

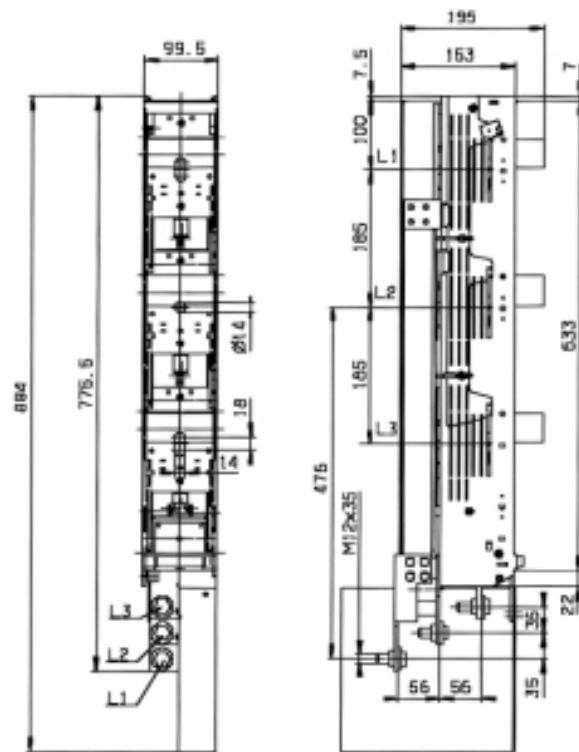

Mounting Width

Dimensions in millimetres

Part Number	Page	Part Number	Page	Part Number	Page	Part Number	Page
1000NH4AG	11	224NH2G-690	17	50NH1G	5	SB00-SV	36
100NH00G-690	13	224NH3G	9	50NH1G-690	15	SB00-VV	36
100NH00M	23	225NH1G	5	50NH1M	25	SB1	37
100NH1G	5	250NH1G	5	50NH2G	7	SB1-MM	37
100NH1G-690	15	250NH1G-690	15	50NHCOOG	1	SB1-MW	37
100NH1M	25	250NH1M	25	50NHCOOM	21	SB1-SW	37
100NH2G	7	250NH2G	7	630NH3G	9	SB1-WW	37
100NH2G-690	17	250NH2G-690	17	630NH3G-690	19	SB2	37
100NH3G	9	250NH2M	27	630NH3M	29	SB2-LM	37
100NHCOOG	1	250NH3G	9	63NH00G-690	13	SB2-LW	37
10NH00G-690	13	25NH00G-690	13	63NH00M	23	SB2-MM	37
10NH1G	5	25NH1G	5	63NH1G	5	SB2-MW	37
10NHCOOG	1	25NHCOOG	1	63NH1G-690	15	SB2-SW	37
10NHCOOM	21	25NHCOOM	21	63NH1M	25	SB2-WW	37
1250NH4AG	11	315NH2G	7	63NH2G	7	SBS00	39
125NH00G	3	315NH2G-690	17	63NHCOOG	1	SBS00-MV	40
125NH1G	5	315NH2M	27	6NH1G	5	SBS00-VV	40
125NH1G-690	15	315NH3G	9	6NHCOOG	1	SBS1	39
125NH1M	25	315NH3G-690	19	6NHCOOM	21	SBS1-MM	40
125NH2G	7	315NH3M	29	800NH4AG	11	SBS1-MW	40
125NH2G-690	17	32NH00G-690	13	80NH00G-690	13	SBS1-SW	40
125NH2M	27	32NH1G	5	80NH00M	23	SBS1-WW	40
125NH3G	9	32NH1G-690	15	80NH1G	5	SBS2	39
12NHCOOM	21	32NHCOOG	1	80NH1G-690	15	SBS2-MM	40
1600NH4AG	11	32NHCOOM	21	80NH1M	25	SBS2-MW	40
160NH00G	3	350NH2G	7	80NH2G	7	SBS2-SW	40
160NH1G	5	350NH2G-690	17	80NHCOOG	1	SBS2-WW	40
160NH1G-690	15	350NH3G	9	8NHCOOM	21	SBS3	39
160NH1M	25	350NH3G-690	19	BFD1 Series	57	SBS3-MM	40
160NH2G	7	35NH1G	5	BFD2 Series	57	SLOO	34
160NH2G-690	17	35NH2G	7	BFD3 Series	45	SL1	34
160NH2M	27	35NHCOOG	1	BFR1 Series	45	SL2	34
160NH3G	9	400NH2G	7	BFR2 Series	45	SL3	34
16NH00G-690	13	400NH2G-690	17	BFR3 Series	45	SL4	34
16NH1G	5	400NH2M	27	BL00 Series	57	TB00	41
16NHCOOG	1	400NH3G	9	EPB00	44	TB00-SV	42
16NHCOOM	21	400NH3G-690	19	EPB1	44	TB00-VV	42
200NH1G	5	400NH3M	29	EPB2	44	TB1	41
200NH1G-690	15	40NH00G-690	13	FEH	43	TB1-MM	42
200NH1M	25	40NH1G	5	FEH-IB	43	TB1-MW	42
200NH2G	7	40NH1G-690	15	FEH-S	43	TB1-SW	42
200NH2G-690	17	40NH1M	25	LBS00	48	TB1-WW	42
200NH2M	27	40NH2G	7	LBS1	48	TB2	41
200NH3G	9	40NHCOOG	1	LBS2	48	TB2-MM	42
20NH00G-690	13	40NHCOOM	21	LBS3	48	TB2-MW	42
20NH1G	5	4NHCOOM	21	LBS4a	48	TB2-SW	42
20NHCOOG	1	500NH3G	9	SB00	36	TB2-WW	42
20NHCOOM	21	500NH3G-690	19	SB00-MM	36		
224NH1G	5	500NH3M	29	SB00-MP	36		
224NH2G	7	50NH00G-690	13	SB00-MV	36		

Table with 2 columns and 20 rows, containing performance data for NH Low Voltage Industrial Fuse links. The table is currently blank.

