

600V Class R Fuse Blocks

R600 Series

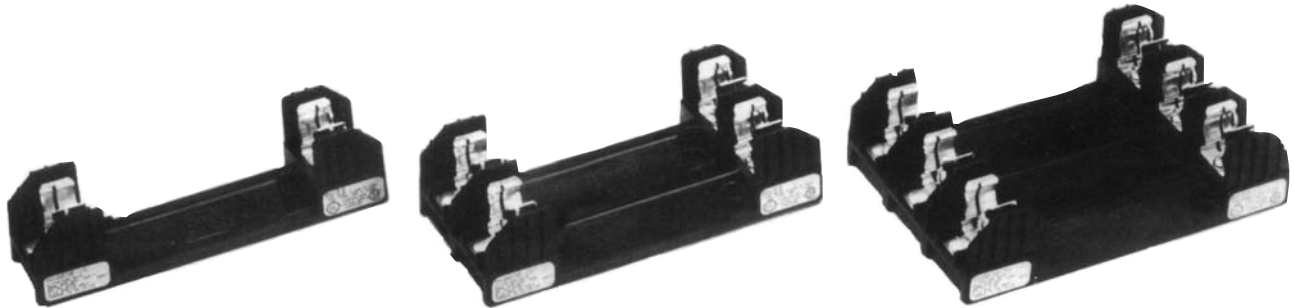

Catalog Symbol: R600 Series

Amp Rating: 1/2 to 600A

Voltage Rating: 600V

Agency Information:

UL Listed, UL 4248, Guide IZLT, File E14853

CSA Certified, C22.2 No. 39, Class 6225-01, File 47235

Withstand Rating (SCCR): 200kA RMS Sym.

For use with Class R fuses (LPS-RK, FRS-R, DLS-R and KTS-R)

UL Flammability: 94V0

Materials: Thermoplastic

Class R Fuseblocks (600V) Catalog Data (for LPS-RK, FRS-R, DLS-R and KTS-R Fuses)

Amps	Poles	Catalog Number	Terminal Type (Suffix No.)					Fig. No.	Wire Range
			Screw w/		Box Lug w/				
			—	Pres. Plate	—	Clip Cu Only	—		
1/2 to 30	1	R60030-1	SR	PR	CR	—	1	COR #6-14 Cu ONLY	
	2	R60030-2	SR	PR	CR	COR	2	CR #2-14 Cu, #2-12 Al	
	3	R60030-3	SR	PR	CR	COR	3	PR, SR #10-18 Cu ONLY	
31 to 60	1	R60060-1	—	—	CR	—	4	CR #2-14 Cu, #2-8 Al	
	2	R60060-2	—	—	CR	—	5		
	3	R60060-3	—	—	CR	—	6		
61 to 100	1	R60100-1	—	—	CR	—	7	CR, 1/0-8 Cu/Al	
	2	R60100-2	—	—	CR	—	8		
	3	R60100-3	—	—	CR	—	9		
101 to 200	1	R60200-1	—	—	CR	—	10	CR 250kcmil-6 Cu/Al	
	3	R60200-3	—	—	CR	—	11		
201 to 400	1	R60400-1	—	—	CR‡	—	12	CR 500kcmil-4 Cu/Al	
	3	R60400-3	—	—	CR‡	—	13		
401 to 600	1	R60600-1	—	—	CR	—	14	CR (2) 500kcmil-4/0 Cu/Al	
	3	R60600-3	—	—	CR‡	—	15		

†No UL, No CSA Certification.

‡UL Recognized, CSA Certification

Dimensional Data: See pages 2 and 3.

Dimensions – in
600V, 1/40 to 30A

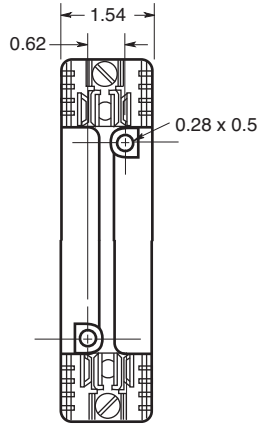
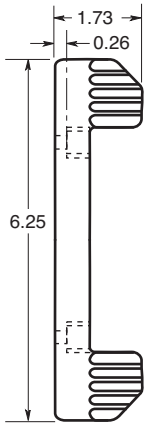

FIGURE 1.

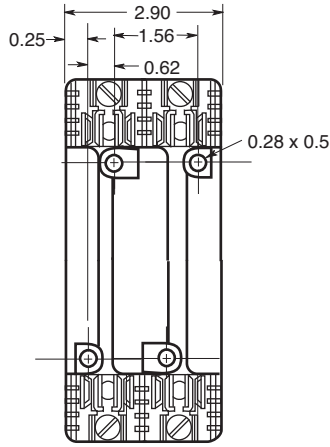

FIGURE 2.

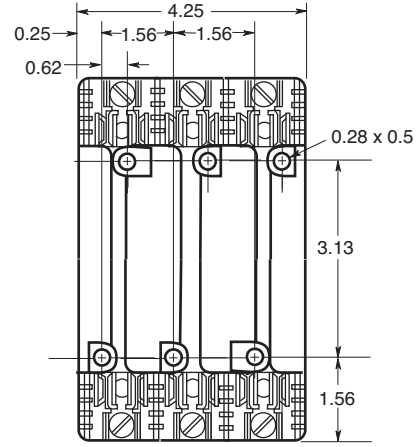

FIGURE 3.

600V, 31 to 60A

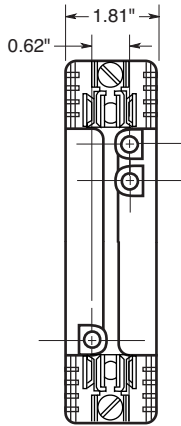
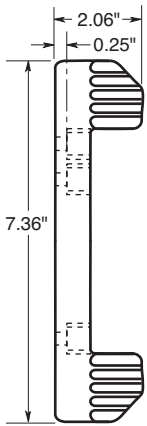

FIGURE 4.

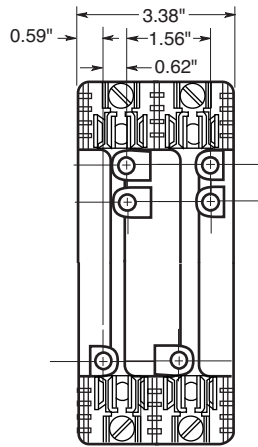

FIGURE 5.

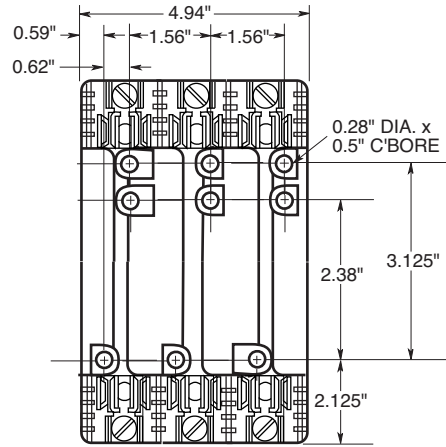

FIGURE 6.

600V, 61 to 100A

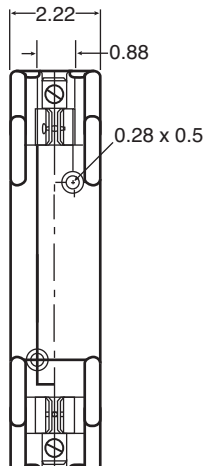
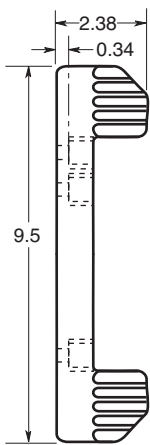

FIGURE 7.

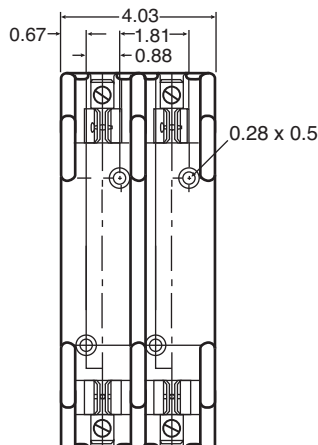

FIGURE 8.

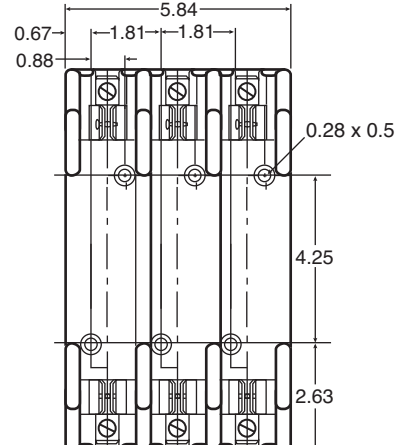

FIGURE 9.

600V, 101 to 200A

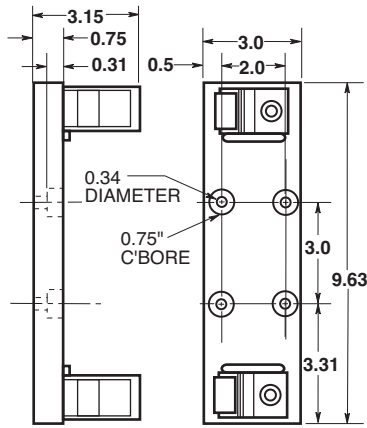

FIGURE 10.

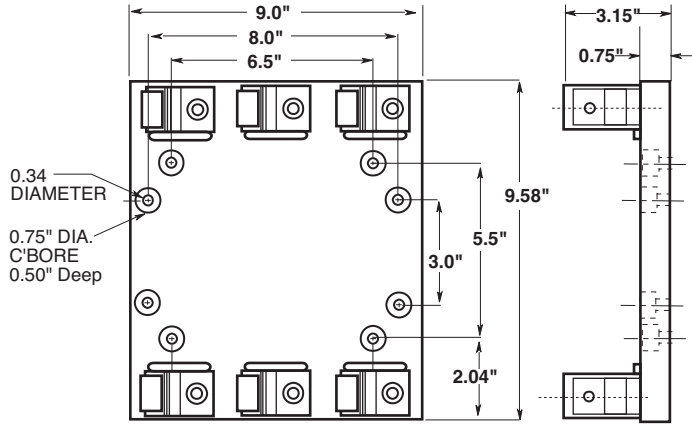

FIGURE 11.

600V, 201 to 400A

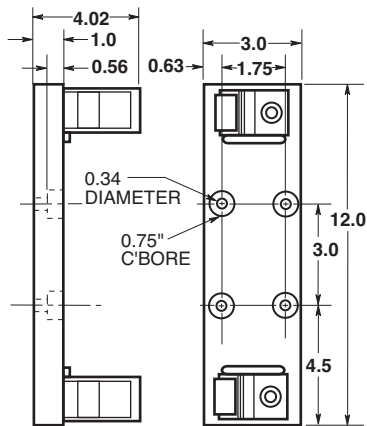

FIGURE 12.

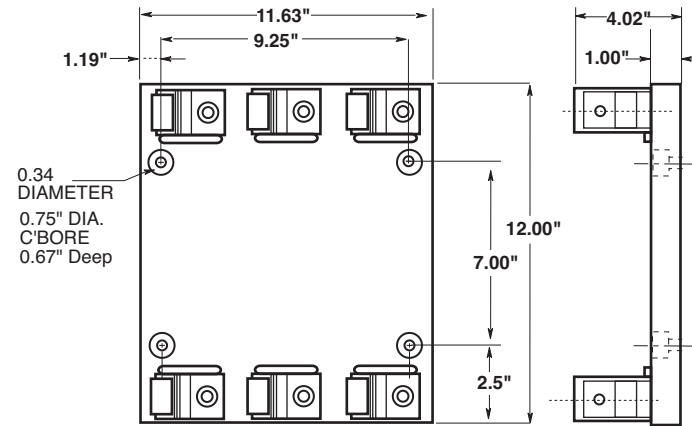

FIGURE 13.

600V, 401 to 600A

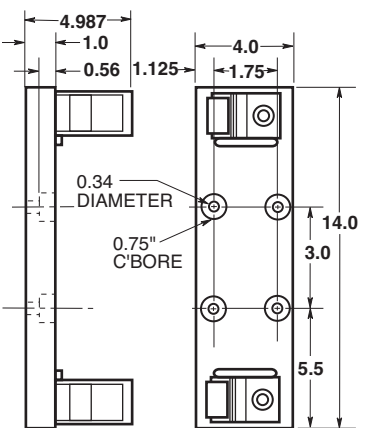

FIGURE 14.

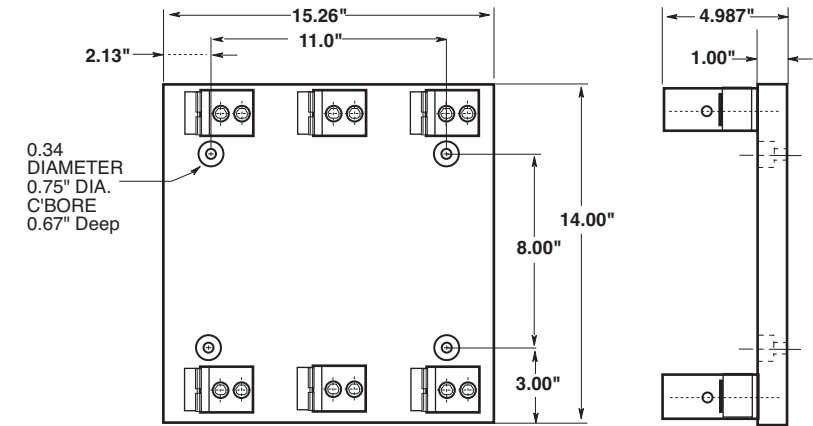

FIGURE 15.

The only controlled copy of this Data Sheet is the electronic read-only version located on the Cooper Bussmann Network Drive. All other copies of this document are by definition uncontrolled. This bulletin is intended to clearly present comprehensive product data and provide technical information that will help the end user with design applications. Cooper Bussmann reserves the right, without notice, to change design or construction of any products and to discontinue or limit distribution of any products. Cooper Bussmann also reserves the right to change or update, without notice, any technical information contained in this bulletin. Once a product has been selected, it should be tested by the user in all possible applications.