

Chip Type Adjustable (pre-set) Ceramic Capacitors

Series: **J**

Series J are miniature in size, thin type surface mounting devices and encased in a thermosetting plastic case.

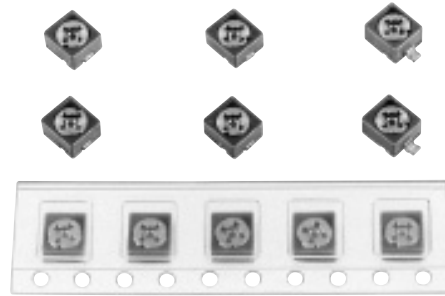

■ Features

- Miniature and thin type SMD: 4.0 x 4.5 x 2.7 mm
- Embossed carrier taping types are available for automatic insertion machines
- Easy reading of capacitance with colored-coded case

■ Recommended Applications

- Hybrid IC and micromodules
- Portable radios and cassette tape players
- VTR cameras
- Paging systems

■ Explanation of Part Numbers

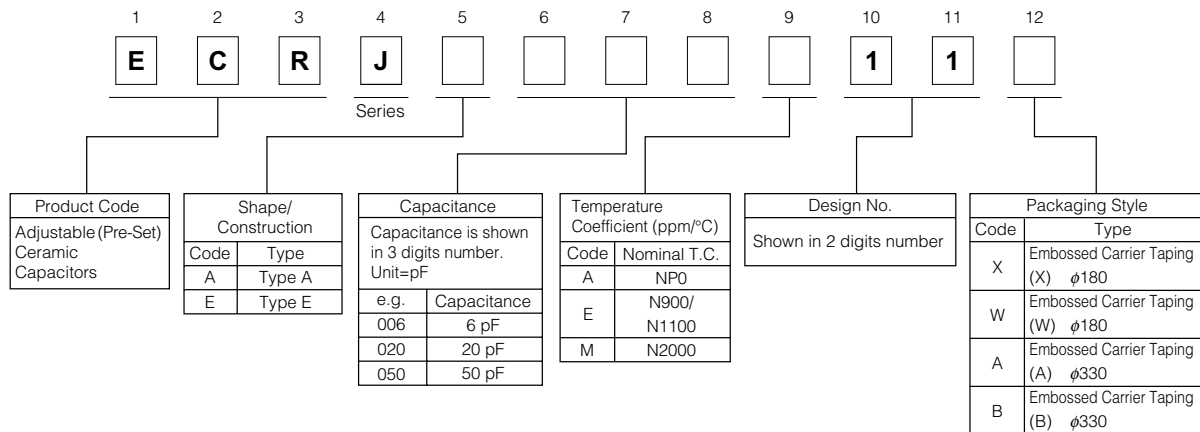

■ Ratings and Characteristics

Item	Ratings
Rated Voltage	100 VDC
Dielectric Withstanding Voltage	220 VDC
Insulation Resistance (at C max.)	10 ⁴ MΩ min. at 100 VDC and 1 minute electrification
Rotation Torque	1.47 to 9.81 mN · m
Operating Temperature Range	-25 to +85 °C

Part Number		Capacitance (pF)		Temperature Coefficient (ppm/°C)	Q (at 1 MHz, C max.)	Color
Type A	Type E	max.	min.			
ECRJA003A11□	ECRJE003A11□	3 ⁺⁵⁰ ₀ %	1.7 max.	NP0±200	300 min.(10 MHz)	White
ECRJA006A11□	ECRJE006A11□	6 ⁺⁵⁰ ₀ %	2.5 max.	NP0±200		Blue
ECRJA010A11□	ECRJE010A11□	10 ⁺⁵⁰ ₀ %	3.5 max.	NP0±300		White
ECRJA020E11□	ECRJE020E11□	20 ⁺⁵⁰ ₀ %	5.5 max.	N900±350	500 min. (10 MHz)	Red
ECRJA030E11□	ECRJE030E11□	30 ⁺⁵⁰ ₀ %	7.5 max.	N1100±450		Green
ECRJA050M11□	ECRJE050M11□	50 ⁺¹⁰⁰ ₀ %	15.0 max.	N2000±600	200 min.(1 MHz)	Orange

Design and specifications are each subject to change without notice. Ask factory for the current technical specifications before purchase and/or use. Should a safety concern arise regarding this product, please be sure to contact us immediately.

■ Dimensions in mm (not to scale)

Type	A	E
	ECRJA□□□□11□	ECRJE□□□□11□
Dimensions in mm		
Recommended Land Layout		

■ Typical Characteristics
Temperature Characteristics

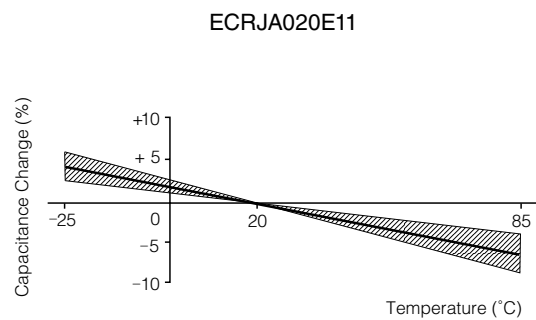
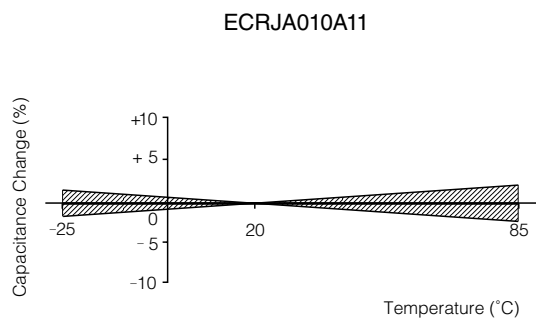

■ Packaging Methods

● Minimum Quantity/Packing Unit

Taped Type	Packaging Style	Part Number	Dia. of reel (mm)	Minimum Packing Quantity	Packaging Quantity in Carton
X	Embossed Carrier Taping	ECRJ□□□□□11X	φ180	700 pcs./reel	3500 pcs.
	Embossed Carrier Taping	ECRJ□□□□□11A	φ330	2500 pcs./reel	—
W	Embossed Carrier Taping	ECRJ□□□□□11W	φ180	700 pcs./reel	3500 pcs.
	Embossed Carrier Taping	ECRJ□□□□□11B	φ330	2500 pcs./reel	—

● Dimensions in mm (not to scale)

Carrier Tape

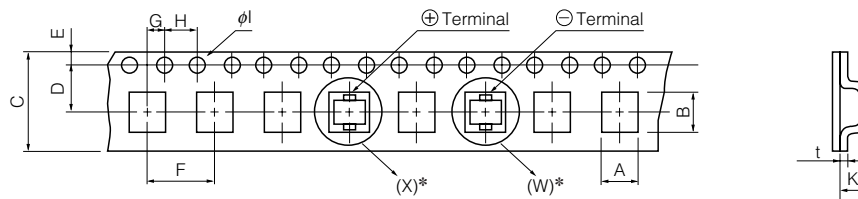

A	B	C	D	E	F	G	H	φl	K	t
4.5±0.2	5.4±0.2	12.0±0.3	5.5±0.1	1.75±0.10	8.0±0.1	2.0±0.1	4.0±0.1	1.5±0.1	3.2±0.2	0.30±0.05

* (X) and (W) denote the package types (polarity direction)

● Dimensions in mm (not to scale)

Reel

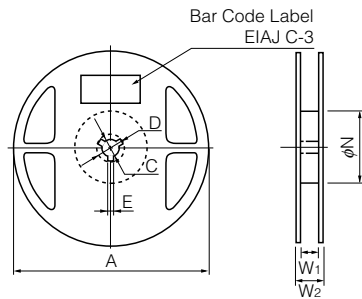

A	C	D	E	φN	W1	W2
180	13	21	2.0	60	13.0	15.4
330	13	22	2.5	80	13.0	19.0

Reusable Reel EIAJ ET-7200 : RRM12B

Recommended Soldering Conditions

Recommendations and precautions are described below.

Recommended soldering conditions for reflow

- Please contact us for additional information when used in conditions other than those specified.
 - The profile error may greatly differ depending on the measuring method.
 - The temperature varies according to the size of board or installation density.
- Therefore please check the temperature for every type of board that may be used.

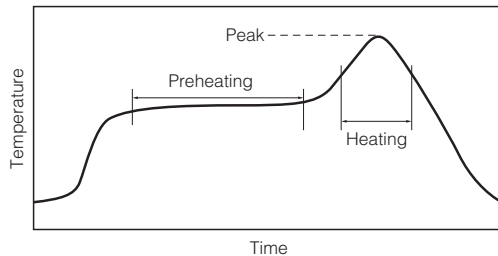

For lead-free soldering (Example : Sn/Ag/Cu)

	Temperature	Time
Preheating	150 °C to 180 °C	60 s to 120 s
Main heating	Above 230 °C	30 s to 40 s
Peak	max. 260 °C	max. 5 s

« Recommended soldering conditions for soldering iron »

When soldering with a soldering iron, or when correcting defective soldering on parts after PWB mounting, solder following these guidelines.

- If the Adjustable (pre-set) Ceramic Capacitor is soldered exceeding the temperature range, functions or characteristics of the capacitor may degrade due to heat stress.
- In addition, the tip must not directly touch the part other than on the terminals.
Otherwise, distortion due to thermal shock grows, and functions of the capacitor may degrade.
 - Solder tip temperature : 380 ± 10 °C
 - Soldering time : 3 s max.

Design Precautions

(1) When mounting Adjustable (pre-set) Ceramic Capacitor on PWB, set the capacitor in such a position and direction that it is free from the effects of PWB warping and deflection.

Mechanical stress due to PWB warping or deflection may cause the functions or characteristics of the capacitor to degrade.

- ① Position : Do not place a capacitor near PWB cuts or broken parts.
- ② Direction : Place the capacitors horizontal to the direction that the stress is applied.

Ex.)

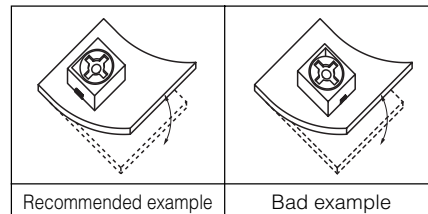

Mounting Precautions

(1) PWB mounting

- ① Select $\phi 3.8$ mm min. (3.8 mm if the contour is a square) for the outer diameter of the nozzle when mounting Adjustable (pre-set) Ceramic Capacitors. Air leakage may occur if the diameter is smaller than 3.8 mm.
- ② When mounting Adjustable (pre-set) Ceramic Capacitors on PWB, make sure that excessive pressure (3.92 N) or shock is not applied.
If the Adjustable (pre-set) Ceramic Capacitor is mounted with a force exceeding the specified pressure, functions of the capacitor may degrade.
- ③ Attach the product in close proximity to the PWB.
Functions or characteristics of the capacitor may degrade if stress is concentrated at the terminals, due to load and rotation torque caused during adjustment.

(2) Flux

- ① Use flux containing less than 0.1 wt% (converted into chlorine) of halogen type substances. Do not use strong acid flux.
If the halogen content is high, or strong acid flux is used the remaining flux after soldering may cause corrosion of terminals or reduction in insulation resistance.
- ② Amounts of Flux used during soldering.
If not enough Flux is used, insufficient fixing may occur. If the amount is too large, flux may get inside the product and may cause the characteristics or functions of the capacitor to degrade.