

Metallized Polyester Film Capacitors MKT Radial Potted Types

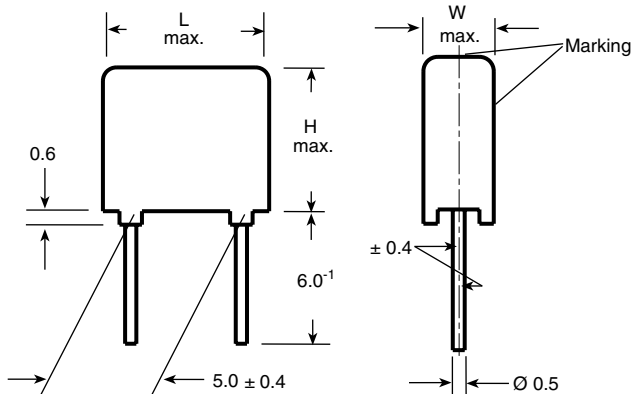

APPLICATIONS

Blocking, bypassing, filtering and timing, high frequency coupling and decoupling for fast digital and analog ICs, interference suppression in low voltage applications.

REFERENCE SPECIFICATIONS

IEC 60384-2

MARKING

Manufacturer's logo/type/C-value/rated/tolerance/date of manufacture

DIELECTRIC

Polyester film

ELECTRODES

Metallized

CONSTRUCTION

Extended metallized film

TEST VOLTAGE (ELECTRODE/ELECTRODE)

1.6 x U_R for 2 s

RATED VOLTAGES (U_R)

63 Vdc, 100 Vdc, 250 Vdc, 400 Vdc

PERMISSIBLE AC VOLTAGES (RMS) UP TO 60 Hz

40 Vac, 63 Vac, 160 Vac, 200 Vac

FEATURES

- Compliant to RoHS directive 2002/95/EC

ENCAPSULATION

Flame retardant plastic case (UL-class 94 V-0), epoxy resin sealed

CLIMATIC TESTING ACC. TO IEC 60068-1

55/100/56

CAPACITANCE RANGE (E12 SERIES)

1000 pF to 1.0 μ F

CAPACITANCE TOLERANCES

$\pm 20\%$ (M), $\pm 10\%$ (K), $\pm 5\%$ (J)

LEADS

Tinned wire

RATED TEMPERATURE

85 °C

OPERATING TEMPERATURE RANGE

- 55 °C to + 100 °C

PULL TEST ON LEADS

≥ 30 N in direction of leads according to IEC 60068-2-21

RELIABILITY

Operational life > 300 000 h

Failure rate < 2 FIT (40 °C/ 0.5 U_R)

DETAIL SPECIFICATION

For more detailed data and test requirements contact:

dc-film@vishay.com



RoHS
COMPLIANT

MKT 1817

Vishay Roederstein

Metallized Polyester Film Capacitors
MKT Radial Potted Types



COMPOSITION OF CATALOG NUMBER

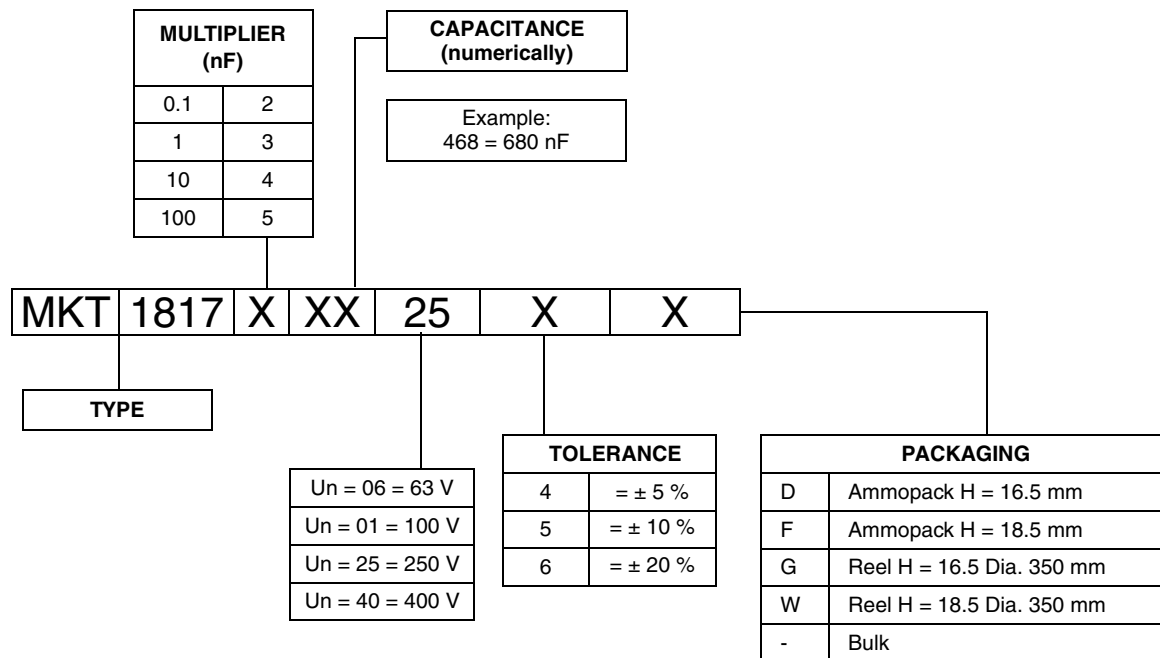

Note

• For detailed tape specifications refer to "Packaging information" www.vishay.com/doc?28139 or end of catalog

SPECIFIC REFERENCE DATA

DESCRIPTION		VALUE		
Tangent of loss angle:		at 1 kHz	at 10 kHz	at 100 kHz
$C \leq 0.1 \mu\text{F}$		$\leq 80 \times 10^{-4}$	$\leq 150 \times 10^{-4}$	$\leq 250 \times 10^{-4}$
$0.1 \mu\text{F} < C \leq 1.0 \mu\text{F}$		$\leq 80 \times 10^{-4}$	$\leq 150 \times 10^{-4}$	-
Pitch (mm)	Rated voltage pulse slope $(dU/dt)_R$ at			
	63 Vdc	100 Vdc	250 Vdc	400 Vdc
5	15	24	44	100
If the maximum pulse voltage is less than the rated voltage higher dU/dt values can be permitted.				
R between leads, for $C \leq 0.33 \mu\text{F}$ and $U_R \leq 100 \text{ V}$		$> 15\,000 \text{ M}\Omega$		
R between leads, for $C \leq 0.33 \mu\text{F}$ and $U_R > 100 \text{ V}$		$> 30\,000 \text{ M}\Omega$		
RC between leads, for $C > 0.33 \mu\text{F}$ and $U_R \leq 100 \text{ V}$		$> 5000 \text{ s}$		
RC between leads, for $C > 0.33 \mu\text{F}$ and $U_R > 100 \text{ V}$		$> 10\,000 \text{ s}$		
R between interconnecting leads and casing 100 V (foil method)		$> 30\,000 \text{ M}\Omega$		
Withstanding (DC) voltage (cut off current 10 mA); rise time 100 V/s		$1.6 \times U_{Rdc}$, 1 min		
Withstanding (DC) voltage between leads and case		$2.0 \times U_{Rdc}$, with minimum of 200 Vdc; 1 min		
Maximum application temperature		100 °C		

 Metallized Polyester Film Capacitors
 MKT Radial Potted Types

Vishay Roederstein

CAPACITANCE	CAPACITANCE CODE	VOLTAGE CODE 06 63 Vdc/40 Vac			VOLTAGE CODE 01 100 Vdc/63 Vac			VOLTAGE CODE 25 250 Vdc/160 Vac			VOLTAGE CODE 40 400 Vdc/200 Vac		
		w (mm)	h (mm)	l (mm)	w (mm)	h (mm)	l (mm)	w (mm)	h (mm)	l (mm)	w (mm)	h (mm)	l (mm)
1000 pF	-210	-	-	-	-	-	-	-	-	-	2.5	6.0	7.5
1500 pF	-215	-	-	-	-	-	-	-	-	-	2.5	6.0	7.5
2200 pF	-222	-	-	-	-	-	-	-	-	-	2.5	6.0	7.5
3300 pF	-233	-	-	-	-	-	-	2.5	6.0	7.5	3.0	6.5	7.5
4700 pF	-247	-	-	-	-	-	-	2.5	6.0	7.5	3.5	8.5	7.5
6800 pF	-268	-	-	-	-	-	-	2.5	6.0	7.5	3.5	8.5	7.5
0.01 μ F	-310	-	-	-	-	-	-	2.5	6.0	7.5	4.5	9.5	7.5
0.015 μ F	-315	-	-	-	-	-	-	2.5	6.0	7.5	4.5	9.5	7.5
0.022 μ F	-322	-	-	-	2.5	6.0	7.5	3.0	6.5	7.5	5.5	11.5	7.5
0.033 μ F	-333	-	-	-	2.5	6.0	7.5	3.5	8.5	7.5	-	-	-
0.047 μ F	-347	-	-	-	2.5	6.0	7.5	4.5	9.5	7.5	-	-	-
0.068 μ F	-368	-	-	-	2.5	6.0	7.5	4.5	9.5	7.5	-	-	-
0.10 μ F	-410	2.5	6.0	7.5	3.5	8.5	7.5	5.5	11.5	7.5	-	-	-
0.15 μ F	-415	3.5	8.5	7.5	4.5	9.5	7.5	-	-	-	-	-	-
0.22 μ F	-422	3.5	8.5	7.5	5.0	10.0	7.5	-	-	-	-	-	-
0.33 μ F	-433	4.5	9.5	7.5	5.5	11.5	7.5	-	-	-	-	-	-
0.47 μ F	-447	5.0	10.0	7.5	-	-	-	-	-	-	-	-	-
0.68 μ F	-468	5.0	10.5	7.5	-	-	-	-	-	-	-	-	-
1.0 μ F	-510	5.5	11.5	7.5	-	-	-	-	-	-	-	-	-

RECOMMENDED PACKAGING

PACKAGING CODE	TYPE OF PACKAGING	HEIGHT (H) (mm)	REEL DIAMETER (mm)	ORDERING CODE EXAMPLES	PITCH 5
D	Ammo	16.5	S ⁽¹⁾	MKT 1817-233-255-D	x
G	Ammo	18.5	S ⁽¹⁾	MKT 1817-233-255-G	x
F	Reel	16.5	350	MKT 1817-233-255-F	x
W	Reel	18.5	350	MKT 1817-233-255-W	x
-	Bulk	-	-	MKT 1817-233-255	x

Note⁽¹⁾ S = box size 55 mm x 210 mm x 340 mm (w x h x l)

MOUNTING

Normal use

The capacitors are designed for mounting on printed-circuit boards. The capacitors packed in bandoliers are designed for mounting on printed-circuit boards by means of automatic insertion machines.

For detailed tape specifications refer to "Packaging Information" www.vishay.com/doc?28139

Specific Method of Mounting to Withstand Vibration and Shock

In order to withstand vibration and shock tests, it must be ensured that the stand-off pips are in good contact with the printed-circuit board:

- For pitches ≤ 15 mm the capacitors shall be mechanically fixed by the leads
- For larger pitches the capacitors shall be mounted in the same way and the body clamped

Space Requirements on Printed-Circuit Board

The maximum length and width of film capacitors is shown in the drawing:

- Eccentricity as in drawing. The maximum eccentricity is smaller than or equal to the lead diameter of the product concerned
- Product height with seating plane as given by "IEC 60717" as reference: $h_{\max.} \leq h + 0.3$ mm

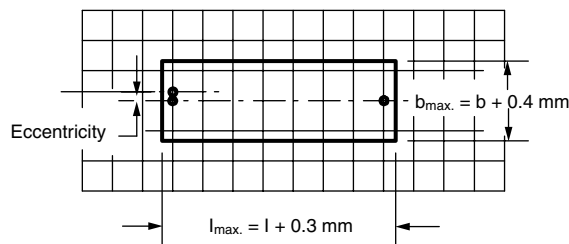

Ratings and Characteristics Reference Conditions

Unless otherwise specified, all electrical values apply to an ambient temperature of $23 \text{ }^{\circ}\text{C} \pm 1 \text{ }^{\circ}\text{C}$, an atmospheric pressure of 86 kPa to 106 kPa and a relative humidity of $50 \% \pm 2 \%$.

For reference testing, a conditioning period shall be applied over $96 \text{ h} \pm 4 \text{ h}$ by heating the products in a circulating air oven at the rated temperature and a relative humidity not exceeding 20 %.



Metallized Polyester Film Capacitors
MKT Radial Potted Types

Vishay Roederstein

Impedance as a function of frequency (typical curve)

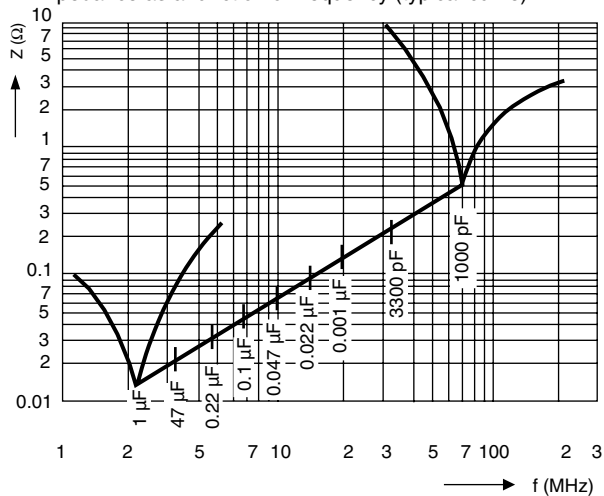

Max. RMS voltage as a function of frequency at $T_{amb} \leq 85^\circ\text{C}$

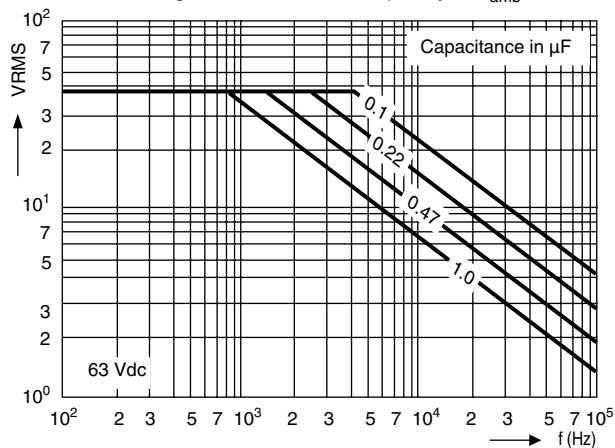

Max. RMS voltage as a function of frequency at $T_{amb} \leq 85^\circ\text{C}$

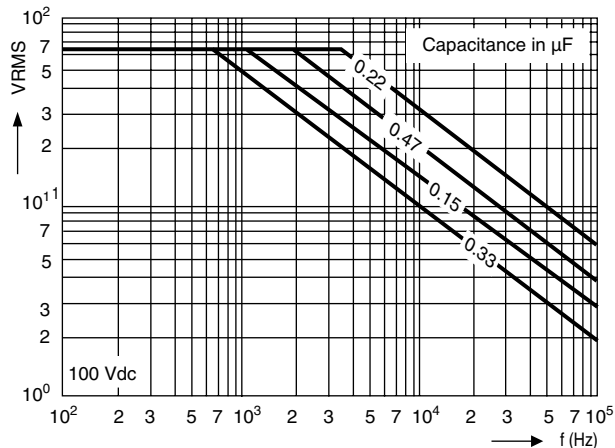

Max. RMS voltage as a function of frequency at $T_{amb} \leq 85^\circ\text{C}$

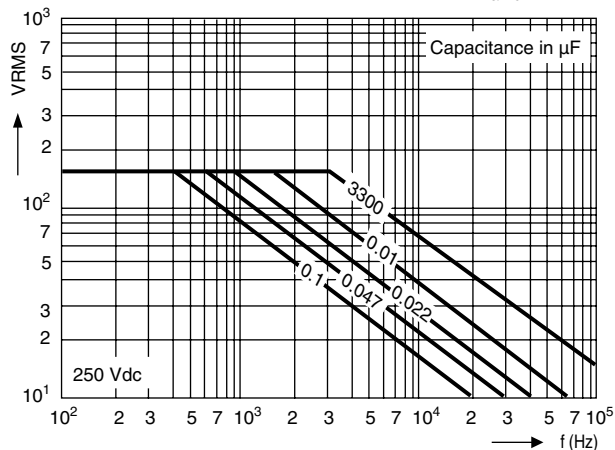

Max. RMS voltage as a function of frequency at $T_{amb} \leq 85^\circ\text{C}$

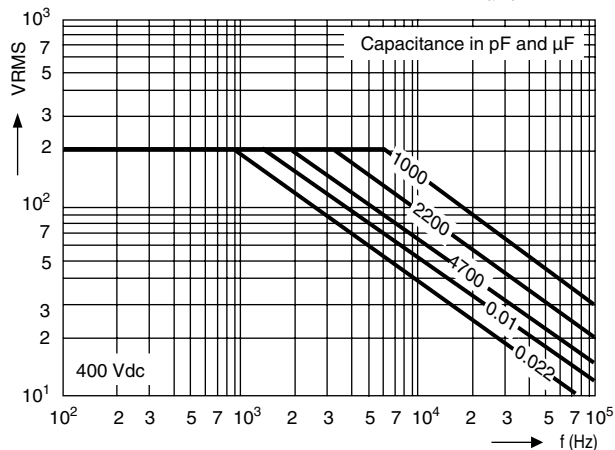



INSPECTION REQUIREMENTS

Sub-clause numbers of tests and performance requirements refer to the “Sectional Specification, Publication IEC 60384-2 and Specific Reference Data”.

Group C Inspection

SUB-CLAUSE NUMBER AND TEST	CONDITIONS	PERFORMANCE REQUIREMENTS
SUB-GROUP C1A PART OF SAMPLE OF SUB-GROUP C1		
4.1 Dimensions (detail)		As specified in chapters “General data” of this specification
4.3.1 Initial measurements	Capacitance Tangent of loss angle: For $C \leq 1 \mu\text{F}$ at 10 kHz for $C > 1 \mu\text{F}$ at 1 kHz	
4.3 Robustness of terminations	Method: 1A Solder bath: $280 \text{ }^\circ\text{C} \pm 5 \text{ }^\circ\text{C}$	No visible damage
4.4 Resistance to soldering heat (see note 3)	Duration: 10 s Isopropylalcohol at room temperature Method: 2	
4.14 Component solvent resistance	Immersion time: $5 \text{ min} \pm 0.5 \text{ min}$ Recovery time: Min. 1 h, max. 2 h	
4.4.2 Final measurements	Visual examination Capacitance Tangent of loss angle	No visible damage Legible marking $ \Delta C/C \leq 2 \%$ of the value measured initially Increase of $\tan \delta$: ≤ 0.003 for: $C \leq 1 \mu\text{F}$ or ≤ 0.002 for: $C > 1 \mu\text{F}$ Compared to values measured in 4.3.1
SUB-GROUP C1B OTHER PART OF SAMPLE OF SUB-GROUP C1		
4.6.1 Initial measurements	Capacitance Tangent of loss angle: For $C \leq 1 \mu\text{F}$ at 10 kHz for $C > 1 \mu\text{F}$ at 1 kHz	
4.6 Rapid change of temperature	$\theta\text{A} = - 55 \text{ }^\circ\text{C}$ $\theta\text{B} = + 100 \text{ }^\circ\text{C}$ 5 cycles Duration $t = 30 \text{ min}$ Visual examination	
4.7 Vibration (see note 3)	Mounting: See section “Mounting” of this specification Procedure B4 Frequency range: 10 Hz to 55 Hz Amplitude: 0.75 mm or Acceleration 98 m/s^2 (whichever is less severe) Total duration 6 h	No visible damage



Metallized Polyester Film Capacitors
MKT Radial Potted Types

Vishay Roederstein

SUB-CLAUSE NUMBER AND TEST	CONDITIONS	PERFORMANCE REQUIREMENTS
4.7.2 Final inspection	Visual examination	No visible damage
4.9 Shock (see note 3)	Mounting: See section "Mounting" of this specification Pulse shape: Half sine Acceleration: 490 m/s ² Duration of pulse: 11 ms	No visible damage $ \Delta C/C \leq 5\%$ of the value measured in 4.6.1 Increase of tan δ : ≤ 0.003 for: $C \leq 1 \mu\text{F}$ or ≤ 0.002 for: $C > 1 \mu\text{F}$ Compared to values measured in 4.6.1 $\geq 50\%$ of values specified in section "Insulation resistance" of this specification
4.9.2 Final measurements	Visual examination Capacitance Tangent of loss angle Insulation resistance	
SUB-GROUP C1 COMBINED SAMPLE OF SPECIMENS OF SUB-GROUPS C1A AND C1B		
4.10 Climatic sequence 4.10.2 Dry heat	Temperature: + 100 °C Duration: 16 h	No breakdown or flash-over No visible damage Legible marking $ \Delta C/C \leq 5\%$ of the value measured in 4.4.2 or 4.9.3. Increase of tan δ : ≤ 0.005 for: $C \leq 1 \mu\text{F}$ or ≤ 0.003 for: $C > 1 \mu\text{F}$ Compared to values measured in 4.3.1. or 4.6.1 $\geq 50\%$ of values specified in section "Insulation resistance" of this specification
4.10.3 Damp heat cyclic Test Db First cycle	Temperature: - 55 °C	
4.10.4 Cold	Duration: 2 h	
4.10.6 Damp heat cyclic Test Db remaining cycles	Voltage proof = U_{Rdc} for 1 min within 15 min after removal from testchamber Visual examination Capacitance Tangent of loss angle Insulation resistance	
4.10.6.2 Final measurements		
SUB-GROUP C2		
4.11 Damp heat steady state 4.11.1 Initial measurements	56 days; 40 °C; 90 % to 95 % RH Capacitance Tangent of loss angle at 1 kHz	



SUB-CLAUSE NUMBER AND TEST	CONDITIONS	PERFORMANCE REQUIREMENTS
4.11.3 Final measurements	Voltage proof = U_{Rdc} for 1 min within 15 min after removal from testchamber Visual examination Capacitance Tangent of loss angle Insulation resistance	No breakdown or flash-over No visible damage Legible marking $ \Delta C/C \leq 5\%$ of the value measured in 4.11.1. Increase of tan δ : ≤ 0.005 for: $C \leq 1 \mu F$ or Compared to values measured in 4.11.1. $\geq 50\%$ of values specified in section "Insulation resistance" of this specification
SUB-GROUP C3		
4.12 Endurance	Duration: 2000 h $1.25 \times U_{Rdc}$ at 85 °C $1.0 \times U_{Rdc}$ at 100 °C	
4.12.1 Initial measurements	Capacitance Tangent of loss angle: For $C \leq 1 \mu F$ at 10 kHz for $C > 1 \mu F$ at 1 kHz	
4.12.5 Final measurements	Visual examination Capacitance Tangent of loss angle Insulation resistance	No visible damage Legible marking $ \Delta C/C \leq 5\%$ compared to values measured in 4.12.1. Increase of tan δ : ≤ 0.003 for: $C \leq 1 \mu F$ or ≤ 0.002 for: $C > 1 \mu F$ Compared to values measured in 4.12.1. $\geq 50\%$ of values specified in section "Insulation resistance" of this specification
SUB-GROUP C4		
4.13 Charge and discharge	10 000 cycles Charged to U_{Rdc} Discharge resistance: $R = \frac{UR}{C \times 5 \times (dU/dt)R}$	
4.13.1 Initial measurements	Capacitance Tangent of loss angle: For $C \leq 1 \mu F$ at 10 kHz for $C > 1 \mu F$ at 1 kHz	
4.13.3 Final measurements	Capacitance Tangent of loss angle Insulation resistance	$ \Delta C/C \leq 3\%$ compared to values measured in 4.13.1. Increase of tan δ : ≤ 0.003 for: $C \leq 1 \mu F$ ≤ 0.002 for: $C > 1 \mu F$ Compared to values measured in 4.13.1. $\geq 50\%$ of values specified in section "Insulation resistance" of this specification



Disclaimer

All product specifications and data are subject to change without notice.

Vishay Intertechnology, Inc., its affiliates, agents, and employees, and all persons acting on its or their behalf (collectively, "Vishay"), disclaim any and all liability for any errors, inaccuracies or incompleteness contained herein or in any other disclosure relating to any product.

Vishay disclaims any and all liability arising out of the use or application of any product described herein or of any information provided herein to the maximum extent permitted by law. The product specifications do not expand or otherwise modify Vishay's terms and conditions of purchase, including but not limited to the warranty expressed therein, which apply to these products.

No license, express or implied, by estoppel or otherwise, to any intellectual property rights is granted by this document or by any conduct of Vishay.

The products shown herein are not designed for use in medical, life-saving, or life-sustaining applications unless otherwise expressly indicated. Customers using or selling Vishay products not expressly indicated for use in such applications do so entirely at their own risk and agree to fully indemnify Vishay for any damages arising or resulting from such use or sale. Please contact authorized Vishay personnel to obtain written terms and conditions regarding products designed for such applications.

Product names and markings noted herein may be trademarks of their respective owners.