

# Metallized Polyester Film Capacitors

## MKT Radial Epoxy Lacquered Type

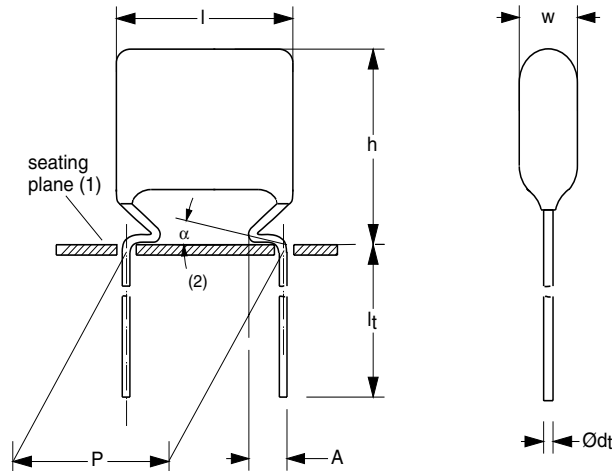

Dimensions in mm

- (1) Hole  $\varnothing$  1.0 for  $d_t = 0.6$  mm  
Hole  $\varnothing$  1.3 for  $d_t = 0.8$  mm
- (2)  $0 \leq \alpha < 50^\circ$
- (3)  $A = 2.0 + 1.0/-0.5$  mm (pitch = 10.0 mm)  
 $A = 2.5 + 1.4/-0.5$  mm (pitch = 15.0 mm, 22.5 mm and 27.5 mm)

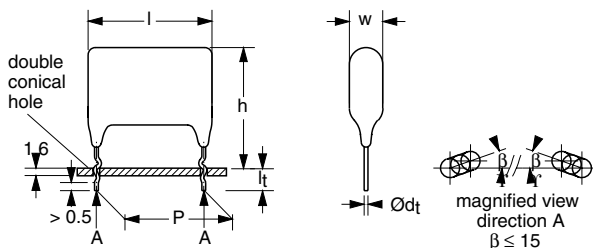

Dimensions in mm

### APPLICATIONS

Blocking and coupling. Bypass and energy reservoir

### MARKING

C-value; tolerance; rated voltage

### DIELECTRIC

Polyester film

### ELECTRODES

Vacuum deposited aluminium

### FEATURES

- Available taped on reel and loose in box
- Lead (Pb)-free product
- RoHS-compliant product



**RoHS**  
COMPLIANT

### COATING

Flame retardant epoxy material (UL-class 94 V-0)

### CONSTRUCTION

Wound mono construction

### LEADS

Tinned wire

### CAPACITANCE RANGE (E12 SERIES)

0.001 to 1.0  $\mu$ F

### CAPACITANCE TOLERANCE

$\pm 10\%$ ;  $\pm 5\%$

### RATED (DC) VOLTAGE

63 V; 100 V; 250 V; 400 V; 630 V

### RATED (AC) VOLTAGE

40 V; 63 V; 160 V; 220 V; 250 V

### CLIMATIC CATEGORY

55/105/56

### RATED TEMPERATURE

85 °C

### MAXIMUM APPLICATION TEMPERATURE

105 °C

### REFERENCE SPECIFICATIONS

IEC 60384-2

### PERFORMANCE GRADE

Grade 1 (long life)

### DETAIL SPECIFICATION

For more detailed data and test requirements see "Type detail specification HQN-384-02/101"



## COMPOSITION OF CATALOG NUMBER

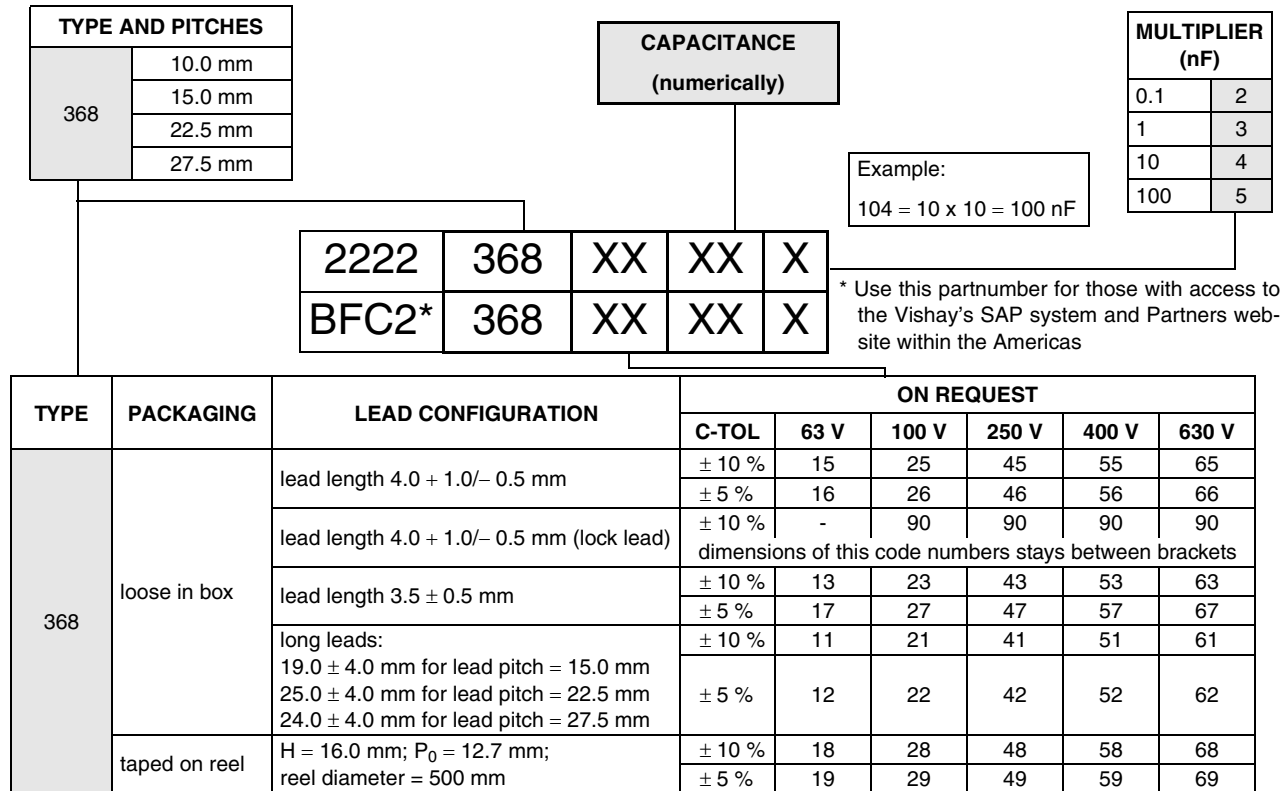

## SPECIFIC REFERENCE DATA

| DESCRIPTION   | VALUE                   |                 |                          |                          |                  |
|---|-------------------------|-----------------|--------------------------|--------------------------|------------------|
|   | at 1 kHz                |                 | at 10 kHz                | at 100 kHz               |                  |
| Tangent of loss angle:  |                         |                 |                          |                          |                  |
| C ≤ 0.1 μF  | ≤ 75 × 10 <sup>-4</sup> |                 | ≤ 130 × 10 <sup>-4</sup> | ≤ 225 × 10 <sup>-4</sup> |                  |
| 0.1 μF < C ≤ 0.47 μF  | ≤ 75 × 10 <sup>-4</sup> |                 | ≤ 130 × 10 <sup>-4</sup> | ≤ 300 × 10 <sup>-4</sup> |                  |
| 0.47 μF < C ≤ 1.0 μF  | ≤ 75 × 10 <sup>-4</sup> |                 | ≤ 130 × 10 <sup>-4</sup> | -                        |                  |
| Rated voltage pulse slope (dU/dt) <sub>R</sub>                          | at 63 V (DC)            | at 100 V (DC)   | at 250 V (DC)            | at 400 V (DC)            | at 630 V (DC)    |
| P = 10 mm   | 30 V/μs                 | 30 V/μs         | 70 V/μs                  | 110 V/μs                 | 70 V/μs          |
| P = 15 mm   |                         | 20 V/μs         | 28 V/μs                  | 44 V/μs                  | 70 V/μs          |
| P = 22.5 mm   |                         | 8 V/μs          | 12 V/μs                  | 20 V/μs                  | 28 V/μs          |
| P = 27.5 mm   |                         | 7 V/μs          | 10 V/μs                  | 16 V/μs                  | 24 V/μs          |
| R between leads, for C ≤ 0.33 μF:                                       |                         |                 |                          |                          |                  |
| at 10 V; 1 minute   | > 15000 MΩ              |                 |                          |                          |                  |
| at 100 V; 1 minute  |                         | > 15000 MΩ      | > 30000 MΩ               | > 30000 MΩ               |                  |
| at 500 V; 1 minute  |                         |                 |                          |                          | > 30000 MΩ       |
| RC between leads, for C > 0.33 μF:                                      |                         |                 |                          |                          |                  |
| at 10 V; 1 minute   | > 5000 s                |                 |                          |                          |                  |
| at 100 V; 1 minute  |                         | > 5000 s        | > 10000 s                | > 10000 s                |                  |
| at 500 V; 1 minute  |                         |                 |                          |                          | > 10000 s        |
| R between interconnecting leads and casing;                             |                         |                 |                          |                          |                  |
| at 10 V; 1 minute   | > 30000 MΩ              |                 |                          |                          |                  |
| at 100 V; 1 minute  |                         | > 30000 MΩ      | > 30000 MΩ               | > 30000 MΩ               |                  |
| at 500 V; 1 minute  |                         |                 |                          |                          | > 30000 MΩ       |
| Withstanding (DC) voltage (cut off current 10 mA);<br>rise time 100 V/s | 100 V; 1 minute         | 160 V; 1 minute | 400 V; 1 minute          | 640 V; 1 minute          | 1008 V; 1 minute |
| Withstanding (DC) voltage between leads and case                        | 200 V; 1 minute         | 200 V; 1 minute | 500 V; 1 minute          | 800 V; 1 minute          | 1260 V; 1 minute |



$U_{Rdc} = 63\text{ V}$ ;  $U_{Rac} = 40\text{ V}$

| C<br>( $\mu\text{F}$ )   | DIMENSIONS<br>$w_{max} \times h_{max} \times l_{max}$<br>(mm) | MASS<br>(g) | CATALOG NUMBER 2222 368 ..... AND PACKAGING |                                    |            |      |                               |      |
|--|---|-------------|---|------------------------------------|------------|------|-------------------------------|------|
|  |   |             | LOOSE IN BOX                                |                                    |            | REEL | LOOSE IN BOX                  |      |
|  |   |             | $l_t =$<br>4.0 + 1.0/- 0.5 mm               | short leads                        | long leads | SPQ  | $l_t =$<br>4.0 + 1.0/- 0.5 mm | SPQ  |
|  |   |             | C-tol = $\pm 10\%$                          |                                    |            |      | C-tol = $\pm 10\%$            |      |
| last 5 digits of<br>catalog number   | SPQ   | SPQ         | SPQ   | last 5 digits of<br>catalog number | SPQ        |      |                               |      |
| <b>Pitch = 10.0 <math>\pm</math> 0.4 mm; <math>d_t = 0.60 \pm 0.06</math> mm</b> |   |             |   |                                    |            |      | <b>lock lead</b>              |      |
| 0.22   | 4.2 $\times$ 13.2 (15.5) $\times$ 12.5                        | 0.5         | 15224                                       | 2000                               | 1000       | 1300 | 90316                         | 1100 |
| 0.27   | 4.0 $\times$ 12.8 (15.5) $\times$ 12.5                        | 0.5         | 15274                                       | 2000                               | 1000       | 1300 | 90317                         | 1100 |
| 0.33   | 4.3 $\times$ 13.1 (15.5) $\times$ 12.5                        | 0.5         | 15334                                       | 2000                               | 1000       | 1300 | 90318                         | 1100 |
| 0.39   | 4.2 $\times$ 12.9 (15.5) $\times$ 12.5                        | 0.5         | 15394                                       | 2000                               | 1000       | 1300 | 90319                         | 1100 |
| 0.47   | 4.3 $\times$ 13.4 (16.0) $\times$ 12.5                        | 0.5         | 15474                                       | 2000                               | 1000       | 1200 | 90321                         | 1000 |
| 0.56   | 4.7 $\times$ 13.7 (16.0) $\times$ 12.5                        | 0.5         | 15564                                       | 2000                               | 1000       | 1200 | 90322                         | 1000 |
| 0.68   | 5.1 $\times$ 14.1 (16.5) $\times$ 12.5                        | 0.6         | 15684                                       | 2000                               | 1000       | 1100 | 90323                         | 1500 |
| 0.82   | 5.5 $\times$ 14.5 (17.0) $\times$ 12.5                        | 0.6         | 15824                                       | 2000                               | 1000       | 1000 | 90324                         | 1250 |
| 1  | 6.0 $\times$ 15.0 (17.5) $\times$ 12.5                        | 0.8         | 15105                                       | 2000                               | 1000       | 900  | 90325                         | 1250 |

$U_{Rdc} = 100\text{ V}$ ;  $U_{Rac} = 63\text{ V}$

| C<br>( $\mu\text{F}$ )   | DIMENSIONS<br>$w_{max} \times h_{max} \times l_{max}$<br>(mm) | MASS<br>(g) | CATALOG NUMBER 2222 368 ..... AND PACKAGING |                                    |            |      |                               |      |
|--|---|-------------|---|------------------------------------|------------|------|-------------------------------|------|
|  |   |             | LOOSE IN BOX                                |                                    |            | REEL | LOOSE IN BOX                  |      |
|  |   |             | $l_t =$<br>4.0 + 1.0/- 0.5 mm               | short leads                        | long leads | SPQ  | $l_t =$<br>4.0 + 1.0/- 0.5 mm | SPQ  |
|  |   |             | C-tol = $\pm 10\%$                          |                                    |            |      | C-tol = $\pm 10\%$            |      |
| last 5 digits of<br>catalog number   | SPQ   | SPQ         | SPQ   | last 5 digits of<br>catalog number | SPQ        |      |                               |      |
| <b>Pitch = 10.0 <math>\pm</math> 0.4 mm; <math>d_t = 0.60 \pm 0.06</math> mm</b> |   |             |   |                                    |            |      | <b>lock lead</b>              |      |
| 0.056  | 4.0 $\times$ 13.0 (15.0) $\times$ 12.5                        | 0.4         | 25563                                       | 2000                               | 1000       | 1500 | 90205                         | 1250 |
| 0.068  |   |             | 25683                                       |                                    |            |      | 90206                         |      |
| 0.082  | 3.7 $\times$ 12.7 (15.0) $\times$ 12.5                        | 0.4         | 25823                                       | 2000                               | 1000       | 1500 | 90207                         | 1250 |
| 0.1  | 4.0 $\times$ 13.0 (15.0) $\times$ 12.5                        | 0.4         | 25104                                       | 2000                               | 1000       | 1500 | 90208                         | 1250 |
| 0.12   | 4.3 $\times$ 13.3 (15.0) $\times$ 12.5                        | 0.4         | 25124                                       | 2000                               | 1000       | 1500 | 90209                         | 1250 |
| 0.15   | 3.9 $\times$ 12.9 (15.0) $\times$ 12.5                        | 0.4         | 25154                                       | 2000                               | 1000       | 1500 | 90211                         | 1250 |
| 0.18   | 4.2 $\times$ 13.2 (15.5) $\times$ 12.5                        | 0.5         | 25184                                       | 2000                               | 1000       | 1300 | 90212                         | 1100 |
| 0.22   | 4.5 $\times$ 13.6 (16.0) $\times$ 12.5                        | 0.5         | 25224                                       | 2000                               | 1000       | 1200 | 90213                         | 1000 |
| <b>Pitch = 15.0 <math>\pm</math> 0.4 mm; <math>d_t = 0.80 \pm 0.08</math> mm</b> |   |             |   |                                    |            |      | <b>lock lead</b>              |      |
| 0.27   | 5.0 $\times$ 14.0 (17.0) $\times$ 17.5                        | 0.6         | 25274                                       | 2000                               | 1000       | 1200 | 90214                         | 1750 |
| 0.33   |   |             | 25334                                       |                                    |            |      | 90215                         |      |
| 0.39   |   |             | 25394                                       |                                    |            |      | 90216                         |      |
| 0.47   | 5.5 $\times$ 14.5 (17.5) $\times$ 17.5                        | 0.7         | 25474                                       | 2000                               | 1000       | 1100 | 90217                         | 1500 |
| 0.56   |   |             | 25564                                       |                                    |            |      | 90218                         |      |
| 0.68   | 6.0 $\times$ 15.0 (18.0) $\times$ 17.5                        | 0.9         | 25684                                       | 2000                               | 1000       | 1000 | 90219                         | 1500 |
| 0.82   | 6.5 $\times$ 15.5 (18.5) $\times$ 17.5                        | 1.0         | 25824                                       | 1000                               | 1000       | 900  | 90221                         | 1250 |
| 1  | 7.5 $\times$ 16.5 (19.5) $\times$ 17.5                        | 1.3         | 25105                                       | 1000                               | 1000       | 800  | 90222                         | 1000 |



| C<br>( $\mu$ F)  | DIMENSIONS<br>$w_{max} \times h_{max} \times l_{max}$<br>(mm) | MASS<br>(g) | CATALOG NUMBER 2222 368 ..... AND PACKAGING |                                    |            |      |                               |      |
|--|---|-------------|---|------------------------------------|------------|------|-------------------------------|------|
|  |   |             | LOOSE IN BOX                                |                                    |            | REEL | LOOSE IN BOX                  |      |
|  |   |             | $l_t =$<br>4.0 + 1.0/- 0.5 mm               | short leads                        | long leads | SPQ  | $l_t =$<br>4.0 + 1.0/- 0.5 mm | SPQ  |
|  |   |             | C-tol = $\pm$ 10 %                          |                                    |            |      | C-tol = $\pm$ 10 %            |      |
| last 5 digits of<br>catalog number   | SPQ   | SPQ         | SPQ   | last 5 digits of<br>catalog number | SPQ        |      |                               |      |
| <b>Pitch = 22.5 <math>\pm</math> 0.4 mm; <math>d_t = 0.80 \pm 0.08</math> mm</b> |   |             |   |                                    |            |      | <b>lock lead</b>              |      |
| 1.2<br>1.5   | 6.0 $\times$ 18.0 (21.0) $\times$ 26.0                        | 2.5         | 25125<br>25155                              | 1000                               | 1000       | 650  | 90223<br>90224                | 1000 |
| 1.8  | 7.0 $\times$ 19.0 (22.0) $\times$ 26.0                        | 3.2         | 25185                                       | 1000                               | 1000       | 650  | 90225                         | 900  |
| 2.2  | 7.5 $\times$ 19.5 (23.0) $\times$ 26.0                        | 3.5         | 25225                                       | 1000                               | 500        | 600  | 90226                         | 750  |
| 2.7  | 8.5 $\times$ 21.5 (24.0) $\times$ 26.0                        | 4.1         | 25275                                       | 1000                               | 500        | 500  | 90227                         | 600  |
| 3.3  | 9.0 $\times$ 22.0 (24.5) $\times$ 26.0                        | 4.5         | 25335                                       | 1000                               | 500        | 450  | 90228                         | 600  |
| <b>Pitch = 27.5 <math>\pm</math> 0.4 mm; <math>d_t = 0.80 \pm 0.08</math> mm</b> |   |             |   |                                    |            |      | <b>lock lead</b>              |      |
| 3.9  | 9.0 $\times$ 22.0 (24.0) $\times$ 30.0                        | 4.8         | 25395                                       | 500                                | 500        |      | 90229                         | 500  |
| 4.7  | 10.0 $\times$ 23.0 (25.0) $\times$ 30.0                       | 5.5         | 25475                                       | 500                                | 500        |      | 90178                         | 400  |
| 5.6  | 11.0 $\times$ 24.0 (26.0) $\times$ 30.0                       | 6.2         | 25565                                       | 500                                | 250        |      | 90231                         | 350  |
| 6.8  | 12.0 $\times$ 25.0 (27.0) $\times$ 30.0                       | 6.8         | 25685                                       | 500                                | 250        |      | 90232                         | 350  |

$U_{Rdc} = 250$  V;  $U_{Rac} = 160$  V

| C<br>( $\mu$ F)  | DIMENSIONS<br>$w_{max} \times h_{max} \times l_{max}$<br>(mm) | MASS<br>(g) | CATALOG NUMBER 2222 368 ..... AND PACKAGING |                                    |            |      |                               |      |
|--|---|-------------|---|------------------------------------|------------|------|-------------------------------|------|
|  |   |             | LOOSE IN BOX                                |                                    |            | REEL | LOOSE IN BOX                  |      |
|  |   |             | $l_t =$<br>4.0 + 1.0/- 0.5 mm               | short leads                        | long leads | SPQ  | $l_t =$<br>4.0 + 1.0/- 0.5 mm | SPQ  |
|  |   |             | C-tol = $\pm$ 10 %                          |                                    |            |      | C-tol = $\pm$ 10 %            |      |
| last 5 digits of<br>catalog number   | SPQ   | SPQ         | SPQ   | last 5 digits of<br>catalog number | SPQ        |      |                               |      |
| <b>Pitch = 10.0 <math>\pm</math> 0.4 mm; <math>d_t = 0.60 \pm 0.06</math> mm</b> |   |             |   |                                    |            |      | <b>lock lead</b>              |      |
| 0.027  | 4.2 $\times$ 13.0 (15.0) $\times$ 12.5                        | 0.4         | 45273                                       | 2000                               | 1000       | 1500 | 90233                         | 1250 |
| 0.033  | 4.6 $\times$ 13.0 (15.0) $\times$ 12.5                        | 0.5         | 45333                                       | 2000                               | 1000       | 1300 | 90234                         | 1250 |
| 0.039  | 4.0 $\times$ 13.0 (15.0) $\times$ 12.5                        | 0.4         | 45393                                       | 2000                               | 1000       | 1500 | 90235                         | 1250 |
| 0.047  | 4.5 $\times$ 13.5 (15.5) $\times$ 12.5                        | 0.5         | 45473                                       | 2000                               | 1000       | 1500 | 90176                         | 1250 |
| 0.056<br>0.068   | 4.6 $\times$ 13.5 (15.5) $\times$ 12.5                        | 0.5         | 45563<br>45683                              | 2000                               | 1000       | 1300 | 90236<br>90237                | 1100 |
| 0.082  | 4.4 $\times$ 13.4 (16.0) $\times$ 12.5                        | 0.5         | 45823                                       | 2000                               | 1000       | 1200 | 90238                         | 1000 |
| 0.1  | 4.7 $\times$ 13.7 (16.0) $\times$ 12.5                        | 0.5         | 45104                                       | 2000                               | 1000       | 1200 | 90177                         | 1000 |
| <b>Pitch = 15.0 <math>\pm</math> 0.4 mm; <math>d_t = 0.80 \pm 0.08</math> mm</b> |   |             |   |                                    |            |      | <b>lock lead</b>              |      |
| 0.12<br>0.15   | 5.0 $\times$ 14.0 (17.0) $\times$ 17.5                        | 0.6         | 45124<br>45154                              | 2000                               | 1000       | 1200 | 90239<br>90241                | 1750 |
| 0.18   | 5.5 $\times$ 14.5 (17.5) $\times$ 17.5                        | 0.7         | 45184                                       | 2000                               | 1000       | 1100 | 90242                         | 1500 |
| 0.22   | 6.0 $\times$ 15.0 (18.0) $\times$ 17.5                        | 0.9         | 45224                                       | 2000                               | 1000       | 1000 | 90243                         | 1500 |
| 0.27   | 6.0 $\times$ 15.5 (18.5) $\times$ 17.5                        | 1.0         | 45274                                       | 2000                               | 1000       | 900  | 90244                         | 1250 |
| 0.33   | 6.8 $\times$ 16.0 (19.0) $\times$ 17.5                        | 1.2         | 45334                                       | 1000                               | 1000       | 800  | 90245                         | 1250 |
| <b>Pitch = 22.5 <math>\pm</math> 0.4 mm; <math>d_t = 0.80 \pm 0.08</math> mm</b> |   |             |   |                                    |            |      | <b>lock lead</b>              |      |
| 0.39   | 5.0 $\times$ 17.0 (20.0) $\times$ 26.0                        | 1.8         | 45394                                       | 1000                               | 1000       | 800  | 90246                         | 1250 |
| 0.47   | 5.5 $\times$ 17.5 (20.5) $\times$ 26.0                        | 2.2         | 45474                                       | 1000                               | 1000       | 750  | 90247                         | 1250 |
| 0.56   | 6.0 $\times$ 18.0 (21.0) $\times$ 26.0                        | 2.5         | 45564                                       | 1000                               | 1000       | 650  | 90248                         | 1000 |
| 0.68   | 6.6 $\times$ 18.5 (21.5) $\times$ 26.0                        | 2.8         | 45684                                       | 1000                               | 1000       | 600  | 90249                         | 1000 |
| 0.82   | 7.2 $\times$ 19.0 (22.0) $\times$ 26.0                        | 3.2         | 45824                                       | 1000                               | 1000       | 550  | 90251                         | 900  |
| 1  | 8.0 $\times$ 20.0 (23.0) $\times$ 26.0                        | 3.8         | 45105                                       | 1000                               | 500        | 500  | 90252                         | 750  |



Metallized Polyester Film Capacitors Vishay BCcomponents  
MKT Radial Epoxy Lacquered Type

| C<br>( $\mu$ F)                                     | DIMENSIONS<br>$w_{max} \times h_{max} \times l_{max}$<br>(mm) | MASS<br>(g) | CATALOG NUMBER 2222 368 ..... AND PACKAGING |                                    |            |      |                               |     |
|---|---|-------------|---|------------------------------------|------------|------|-------------------------------|-----|
|   |   |             | LOOSE IN BOX                                |                                    |            | REEL | LOOSE IN BOX                  |     |
|   |   |             | $l_t =$<br>4.0 + 1.0/- 0.5 mm               | short leads                        | long leads | SPQ  | $l_t =$<br>4.0 + 1.0/- 0.5 mm | SPQ |
|   |   |             | C-tol = $\pm$ 10 %                          |                                    |            |      | C-tol = $\pm$ 10 %            |     |
| last 5 digits of<br>catalog number                  | SPQ   | SPQ         | SPQ   | last 5 digits of<br>catalog number | SPQ        |      |                               |     |
| Pitch = 27.5 $\pm$ 0.4 mm; $d_t = 0.80 \pm 0.08$ mm |   |             |   |                                    |            |      | lock lead                     |     |
| 1.2   | 8.0 $\times$ 21.0 (23.0) $\times$ 30.0                        | 4.1         | 45125                                       | 500                                | 500        |      | 90253                         | 600 |
| 1.5   | 9.0 $\times$ 22.0 (25.0) $\times$ 30.0                        | 4.8         | 45155                                       | 500                                | 500        |      | 90254                         | 450 |
| 1.8   | 10.0 $\times$ 23.0 (26.0) $\times$ 30.0                       | 5.5         | 45185                                       | 500                                | 500        |      | 90255                         | 400 |
| 2.2   | 11.0 $\times$ 24.0 (27.0) $\times$ 30.0                       | 6.2         | 45225                                       | 500                                | 250        |      | 90256                         | 350 |

$U_{Rdc} = 400$  V;  $U_{Rac} = 220$  V

| C<br>( $\mu$ F)                                     | DIMENSIONS<br>$w_{max} \times h_{max} \times l_{max}$<br>(mm) | MASS<br>(g) | CATALOG NUMBER 2222 368 ..... AND PACKAGING |                                    |            |      |                               |      |
|---|---|-------------|---|------------------------------------|------------|------|-------------------------------|------|
|   |   |             | LOOSE IN BOX                                |                                    |            | REEL | LOOSE IN BOX                  |      |
|   |   |             | $l_t =$<br>4.0 + 1.0/- 0.5 mm               | short leads                        | long leads | SPQ  | $l_t =$<br>4.0 + 1.0/- 0.5 mm | SPQ  |
|   |   |             | C-tol = $\pm$ 10 %                          |                                    |            |      | C-tol = $\pm$ 10 %            |      |
| last 5 digits of<br>catalog number                  | SPQ   | SPQ         | SPQ   | last 5 digits of<br>catalog number | SPQ        |      |                               |      |
| Pitch = 10.0 $\pm$ 0.4 mm; $d_t = 0.60 \pm 0.06$ mm |   |             |   |                                    |            |      | lock lead                     |      |
| 0.001   | 4.5 $\times$ 13.5 (15.5) $\times$ 12.5                        | 0.5         | 55102                                       | 2000                               | 1000       | 1500 | 90257                         | 1100 |
| 0.0012  |   |             | 55122                                       |                                    |            |      | 90258                         |      |
| 0.0015  |   |             | 55152                                       |                                    |            |      | 90259                         |      |
| 0.0018  |   |             | 55182                                       |                                    |            |      | 90261                         |      |
| 0.0022  | 4.0 $\times$ 13.0 (15.5) $\times$ 12.5                        | 0.5         | 55222                                       | 2000                               | 1000       | 1500 | 90262                         | 1100 |
| 0.0027  | 4.3 $\times$ 13.3 (15.5) $\times$ 12.5                        | 0.5         | 55272                                       | 2000                               | 1000       | 1500 | 90263                         | 1100 |
| 0.0033  | 4.6 $\times$ 13.6 (15.5) $\times$ 12.5                        | 0.5         | 55332                                       | 2000                               | 1000       | 1500 | 90264                         | 1100 |
| 0.0039  | 4.0 $\times$ 13.0 (15.5) $\times$ 12.5                        | 0.5         | 55392                                       | 2000                               | 1000       | 1500 | 90265                         | 1100 |
| 0.0047  | 4.1 $\times$ 13.2 (15.5) $\times$ 12.5                        | 0.5         | 55472                                       | 2000                               | 1000       | 1500 | 90266                         | 1100 |
| 0.0056  | 4.6 $\times$ 13.6 (15.5) $\times$ 12.5                        | 0.5         | 55562                                       | 2000                               | 1000       | 1500 | 90267                         | 1100 |
| 0.0068  |   |             | 55682                                       |                                    |            |      | 90268                         |      |
| 0.0082  |   |             | 55822                                       |                                    |            |      | 90269                         |      |
| 0.01  |   |             | 55103                                       |                                    |            |      | 90271                         |      |
| 0.012   | 4.0 $\times$ 13.0 (15.5) $\times$ 12.5                        | 0.5         | 55123                                       | 2000                               | 1000       | 1500 | 90272                         | 1100 |
| 0.015   | 4.1 $\times$ 13.0 (15.5) $\times$ 12.5                        | 0.5         | 55153                                       | 2000                               | 1000       | 1300 | 90273                         | 1100 |
| 0.018   | 4.4 $\times$ 13.0 (15.5) $\times$ 12.5                        | 0.5         | 55183                                       | 2000                               | 1000       | 1500 | 90274                         | 1100 |
| 0.022   | 4.2 $\times$ 12.9 (15.5) $\times$ 12.5                        | 0.5         | 55223                                       | 2000                               | 1000       | 1500 | 90175                         | 1100 |
| 0.027   | 4.2 $\times$ 13.2 (15.5) $\times$ 12.5                        | 0.5         | 55273                                       | 2000                               | 1000       | 1300 | 90275                         | 1100 |
| 0.033   | 4.6 $\times$ 13.7 (15.5) $\times$ 12.5                        | 0.5         | 55333                                       | 2000                               | 1000       | 1300 | 90188                         | 1100 |
| Pitch = 15.0 $\pm$ 0.4 mm; $d_t = 0.80 \pm 0.08$ mm |   |             |   |                                    |            |      | lock lead                     |      |
| 0.039   | 5.0 $\times$ 13.9 (16.5) $\times$ 17.5                        | 0.6         | 55393                                       | 2000                               | 1000       | 1200 | 90276                         | 2000 |
| 0.047   | 5.4 $\times$ 14.5 (17.0) $\times$ 17.5                        | 0.7         | 55473                                       | 2000                               | 1000       | 1200 | 90277                         | 1750 |
| 0.056   | 5.0 $\times$ 13.7 (16.5) $\times$ 17.5                        | 0.6         | 55563                                       | 2000                               | 1000       | 1200 | 90278                         | 2000 |
| 0.068   | 5.0 $\times$ 13.5 (16.5) $\times$ 17.5                        | 0.6         | 55683                                       | 2000                               | 1000       | 1200 | 90279                         | 2000 |
| 0.082   | 4.8 $\times$ 14.0 (16.5) $\times$ 17.5                        | 0.6         | 55823                                       | 2000                               | 1000       | 1100 | 90281                         | 2000 |
| 0.1   | 5.3 $\times$ 14.5 (17.5) $\times$ 17.5                        | 0.7         | 55104                                       | 2000                               | 1000       | 1000 | 90186                         | 1500 |
| 0.12  | 5.7 $\times$ 15.0 (18.0) $\times$ 17.5                        | 0.9         | 55124                                       | 1000                               | 1000       | 900  | 90282                         | 1500 |
| 0.15  | 6.4 $\times$ 15.5 (18.5) $\times$ 17.5                        | 1.0         | 55154                                       | 1000                               | 1000       | 800  | 90187                         | 1250 |



| C<br>( $\mu$ F)   | DIMENSIONS<br>$W_{max} \times h_{max} \times l_{max}$<br>(mm) | MASS<br>(g) | CATALOG NUMBER 2222 368 ..... AND PACKAGING |                                    |            |      |                               |      |
|---|---|-------------|---|------------------------------------|------------|------|-------------------------------|------|
|   |   |             | LOOSE IN BOX                                |                                    |            | REEL | LOOSE IN BOX                  |      |
|   |   |             | $l_t =$<br>4.0 + 1.0/- 0.5 mm               | short leads                        | long leads | SPQ  | $l_t =$<br>4.0 + 1.0/- 0.5 mm | SPQ  |
|   |   |             | C-tol = $\pm$ 10 %                          |                                    |            |      | C-tol = $\pm$ 10 %            |      |
| last 5 digits of<br>catalog number  | SPQ   | SPQ         | SPQ   | last 5 digits of<br>catalog number | SPQ        |      |                               |      |
| <b>Pitch = 22.5 <math>\pm</math> 0.4 mm; <math>d_t</math> = 0.80 <math>\pm</math> 0.08 mm</b> |   |             |   |                                    |            |      | <b>lock lead</b>              |      |
| 0.18  | 5.6 $\times$ 17.5 (20.5) $\times$ 26.0                        | 2.2         | 55184                                       | 1000                               | 1000       | 800  | 90283                         | 1250 |
| 0.22  | 6.3 $\times$ 18.5 (21.5) $\times$ 26.0                        | 2.8         | 55224                                       | 1000                               | 1000       | 650  | 90284                         | 1000 |
| 0.27  | 6.0 $\times$ 18.0 (21.0) $\times$ 26.0                        | 2.5         | 55274                                       | 1000                               | 1000       | 650  | 90285                         | 1000 |
| 0.33  | 6.4 $\times$ 18.5 (21.5) $\times$ 26.0                        | 2.8         | 55334                                       | 1000                               | 1000       | 650  | 90286                         | 1000 |
| 0.39  | 7.1 $\times$ 19.0 (21.5) $\times$ 26.0                        | 2.8         | 55394                                       | 1000                               | 1000       | 550  | 90287                         | 900  |
| 0.47  | 8.0 $\times$ 20.0 (22.5) $\times$ 26.0                        | 3.8         | 55474                                       | 1000                               | 500        | 500  | 90179                         | 750  |
| <b>Pitch = 27.5 <math>\pm</math> 0.4 mm; <math>d_t</math> = 0.80 <math>\pm</math> 0.08 mm</b> |   |             |   |                                    |            |      | <b>lock lead</b>              |      |
| 0.56  | 7.5 $\times$ 20.5 (22.5) $\times$ 30.0                        | 3.8         | 55564                                       | 500                                | 500        |      | 90288                         | 600  |
| 0.68  | 8.5 $\times$ 21.5 (23.5) $\times$ 30.0                        | 4.5         | 55684                                       | 500                                | 500        |      | 90289                         | 500  |
| 0.82  | 9.5 $\times$ 22.5 (24.5) $\times$ 30.0                        | 5.2         | 55824                                       | 500                                | 500        |      | 90291                         | 450  |
| 1   | 10.5 $\times$ 23.5 (26.5) $\times$ 30.0                       | 5.8         | 55105                                       | 500                                | 250        |      | 90292                         | 350  |

$U_{Rdc} = 630$  V;  $U_{Rac} = 250$  V

| C<br>( $\mu$ F)   | DIMENSIONS<br>$W_{max} \times h_{max} \times l_{max}$<br>(mm) | MASS<br>(g) | CATALOG NUMBER 2222 368 ..... AND PACKAGING |                                    |            |      |                               |      |
|---|---|-------------|---|------------------------------------|------------|------|-------------------------------|------|
|   |   |             | LOOSE IN BOX                                |                                    |            | REEL | LOOSE IN BOX                  |      |
|   |   |             | $l_t =$<br>4.0 + 1.0/- 0.5 mm               | short leads                        | long leads | SPQ  | $l_t =$<br>4.0 + 1.0/- 0.5 mm | SPQ  |
|   |   |             | C-tol = $\pm$ 10 %                          |                                    |            |      | C-tol = $\pm$ 10 %            |      |
| last 5 digits of<br>catalog number  | SPQ   | SPQ         | SPQ   | last 5 digits of<br>catalog number | SPQ        |      |                               |      |
| <b>Pitch = 10.0 <math>\pm</math> 0.4 mm; <math>d_t</math> = 0.60 <math>\pm</math> 0.06 mm</b> |   |             |   |                                    |            |      | <b>lock lead</b>              |      |
| 0.01  | 4.3 $\times$ 13.1 (15.5) $\times$ 12.5                        | 0.5         | 65103                                       | 2000                               | 1000       | 1300 | 90293                         | 1100 |
| 0.012   | 4.6 $\times$ 13.4 (16.0) $\times$ 12.5                        | 0.5         | 65123                                       | 2000                               | 1000       | 1200 | 90294                         | 1000 |
| 0.015   | 4.9 $\times$ 13.9 (16.5) $\times$ 12.5                        | 0.6         | 65153                                       | 2000                               | 1000       | 1100 | 90295                         | 1500 |
| 0.018   | 5.3 $\times$ 14.3 (17.0) $\times$ 12.5                        | 0.6         | 65183                                       | 2000                               | 1000       | 1000 | 90296                         | 1250 |
| 0.022   | 5.9 $\times$ 14.9 (17.5) $\times$ 12.5                        | 0.8         | 65223                                       | 2000                               | 1000       | 900  | 90297                         | 1250 |
| <b>Pitch = 15.0 <math>\pm</math> 0.4 mm; <math>d_t</math> = 0.80 <math>\pm</math> 0.08 mm</b> |   |             |   |                                    |            |      | <b>lock lead</b>              |      |
| 0.027   | 5.5 $\times$ 14.5 (17.5) $\times$ 17.5                        | 0.7         | 65273                                       | 2000                               | 1000       | 1100 | 90298                         | 1500 |
| 0.033   | 6.0 $\times$ 15.0 (18.0) $\times$ 17.5                        | 0.9         | 65333                                       | 2000                               | 1000       | 1000 | 90299                         | 1500 |
| 0.039   | 6.3 $\times$ 15.5 (18.5) $\times$ 17.5                        | 1.0         | 65393                                       | 2000                               | 1000       | 900  | 90301                         | 1250 |
| 0.047   | 7.0 $\times$ 16.0 (19.0) $\times$ 17.5                        | 1.2         | 65473                                       | 2000                               | 1000       | 800  | 90302                         | 1250 |
| 0.056   | 7.5 $\times$ 16.5 (19.5) $\times$ 17.5                        | 1.3         | 65563                                       | 1000                               | 1000       | 800  | 90303                         | 1000 |
| 0.068   | 8.0 $\times$ 17.0 (20.0) $\times$ 17.5                        | 1.4         | 65683                                       | 1000                               | 1000       | 750  | 90304                         | 1000 |
| <b>Pitch = 22.5 <math>\pm</math> 0.4 mm; <math>d_t</math> = 0.80 <math>\pm</math> 0.08 mm</b> |   |             |   |                                    |            |      | <b>lock lead</b>              |      |
| 0.082   | 6.1 $\times$ 18.0 (21.0) $\times$ 26.0                        | 2.5         | 65823                                       | 1000                               | 1000       | 750  | 90305                         | 1000 |
| 0.1   | 7.0 $\times$ 19.0 (22.0) $\times$ 26.0                        | 3.2         | 65104                                       | 1000                               | 1000       | 650  | 90306                         | 900  |
| 0.12  | 7.2 $\times$ 19.5 (22.5) $\times$ 26.0                        | 3.5         | 65124                                       | 1000                               | 1000       | 550  | 90307                         | 750  |
| 0.15  | 8.0 $\times$ 21.0 (23.0) $\times$ 26.0                        | 3.8         | 65154                                       | 1000                               | 500        | 500  | 90308                         | 750  |
| 0.18  | 9.0 $\times$ 22.0 (24.0) $\times$ 26.0                        | 4.5         | 65184                                       | 1000                               | 500        | 450  | 90309                         | 600  |
| 0.22  | 10.0 $\times$ 23.0 (25.0) $\times$ 26.0                       | 5.2         | 65224                                       | 1000                               | 500        | 400  | 90311                         | 550  |



| C<br>( $\mu$ F)                                     | DIMENSIONS<br>$w_{max} \times h_{max} \times l_{max}$<br>(mm) | MASS<br>(g) | CATALOG NUMBER 2222 368 ..... AND PACKAGING |             |            |      |                                 |     |     |
|---|---|-------------|---|-------------|------------|------|---------------------------------|-----|-----|
|   |   |             | LOOSE IN BOX                                |             |            | REEL | LOOSE IN BOX                    |     |     |
|   |   |             | $l_t =$<br>4.0 + 1.0/- 0.5 mm               | short leads | long leads | SPQ  | $l_t =$<br>4.0 + 1.0/- 0.5 mm   | SPQ |     |
|   |   |             | C-tol = $\pm 10\%$                          |             |            |      | C-tol = $\pm 10\%$              |     |     |
| last 5 digits of catalog number                     |   |             |   |             |            | SPQ  | last 5 digits of catalog number |     | SPQ |
| Pitch = 27.5 $\pm$ 0.4 mm; $d_t = 0.80 \pm 0.08$ mm |   |             |   |             |            |      | lock lead                       |     |     |
| 0.27  | 10.0 $\times$ 23.0 (25.0) $\times$ 30.0                       | 5.5         | 65274                                       | 500         | 500        |      | 90312                           | 400 |     |
| 0.33  | 11.5 $\times$ 24.5 (26.5) $\times$ 30.0                       | 6.5         | 65334                                       | 500         | 250        |      | 90313                           | 350 |     |
| 0.39  | 12.5 $\times$ 25.5 (28.5) $\times$ 30.0                       | 7.1         | 65394                                       | 500         | 250        |      | 90314                           | 300 |     |
| 0.47  | 14.0 $\times$ 27.0 (30.0) $\times$ 30.0                       | 8.2         | 65474                                       | 250         | 250        |      | 90315                           | 250 |     |

**CAPACITANCE**

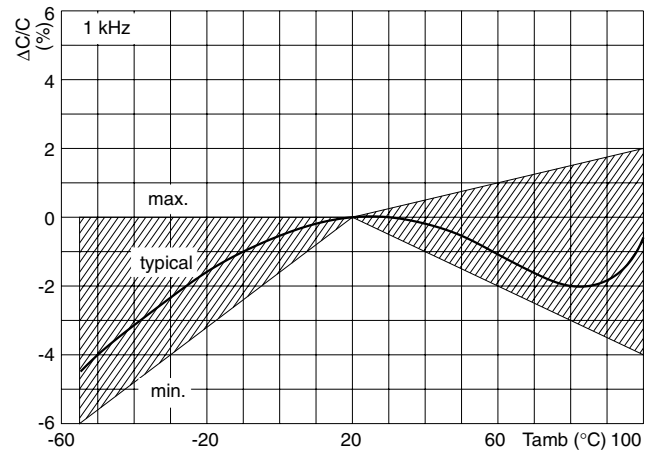
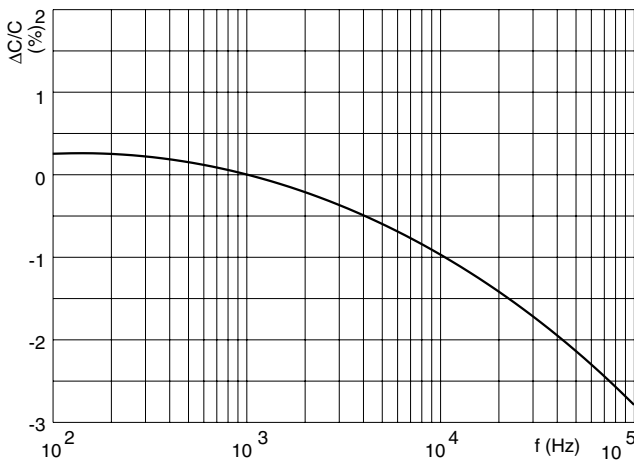

**IMPEDANCE**

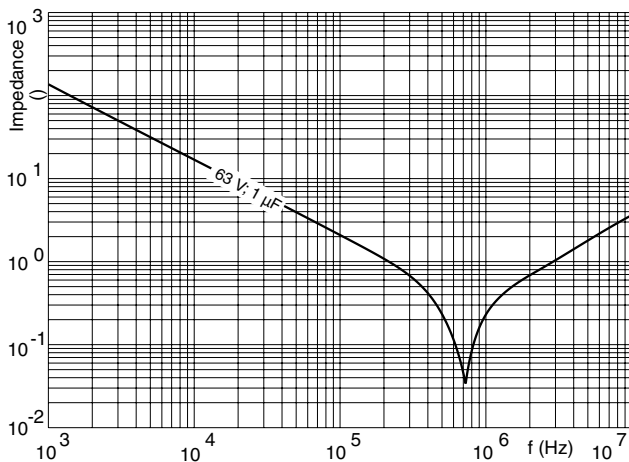

## MAXIMUM RMS VOLTAGE (SINEWAVE) AS A FUNCTION OF FREQUENCY

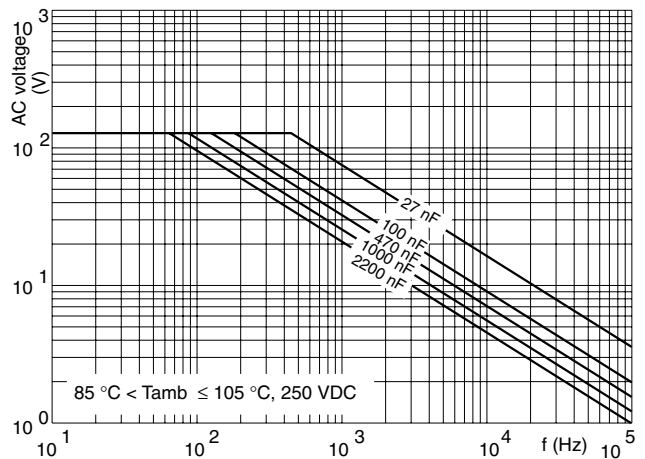
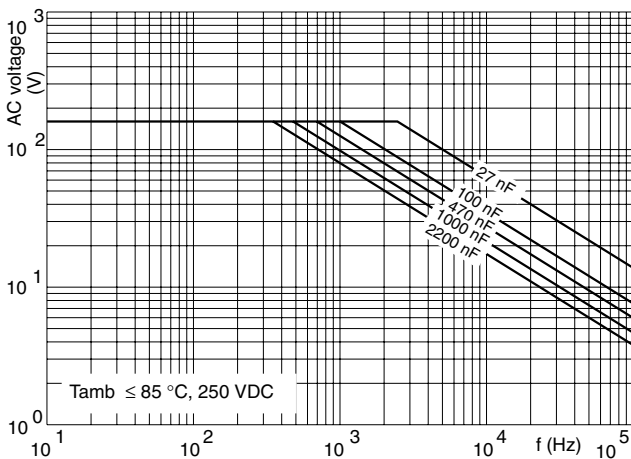
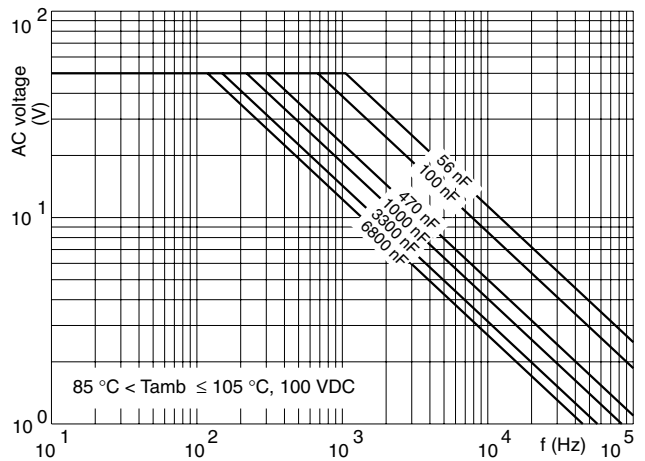
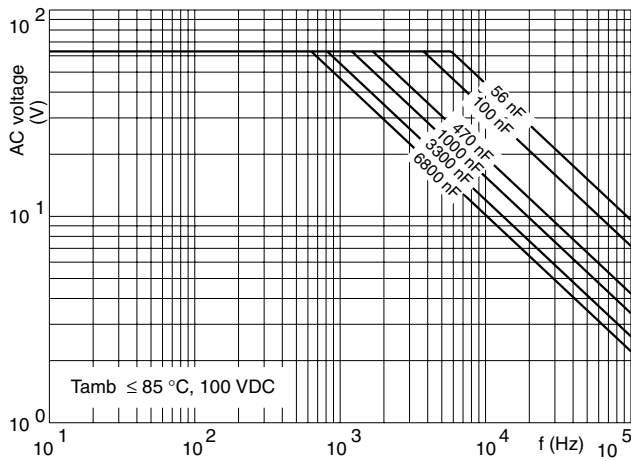
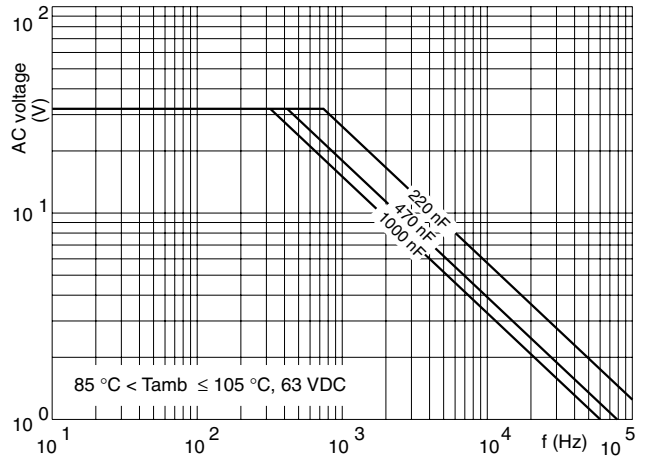
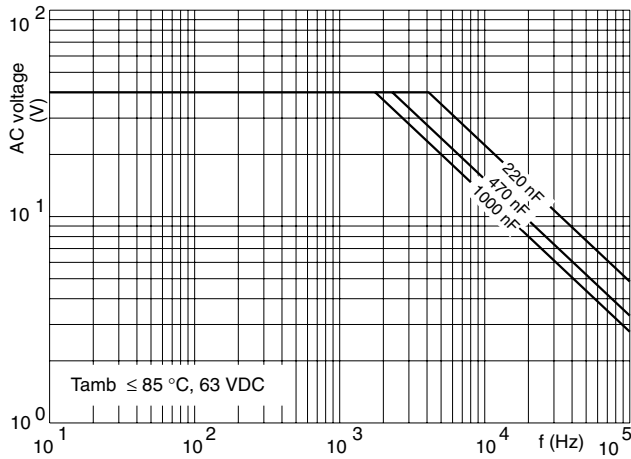



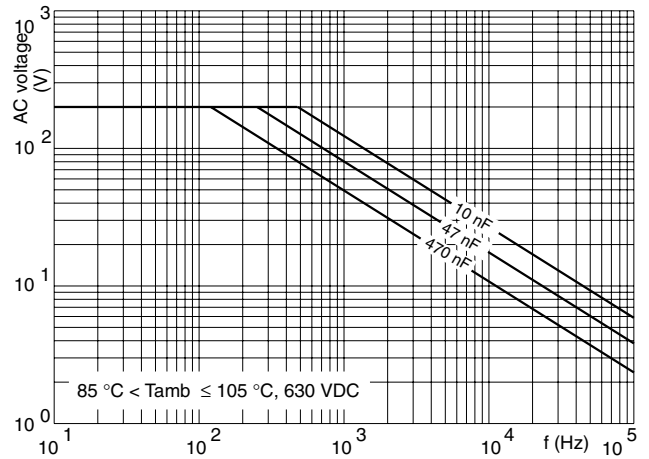
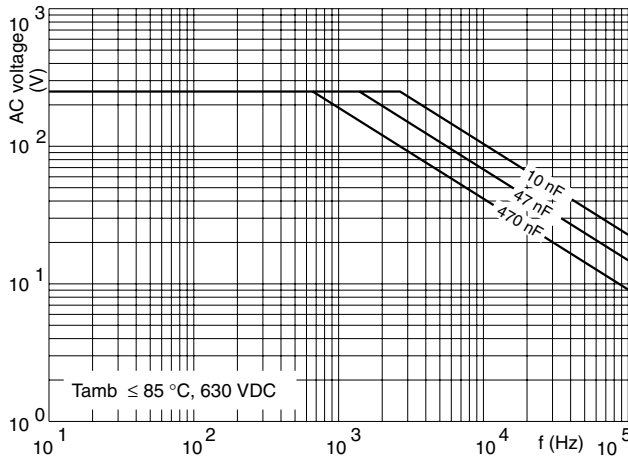
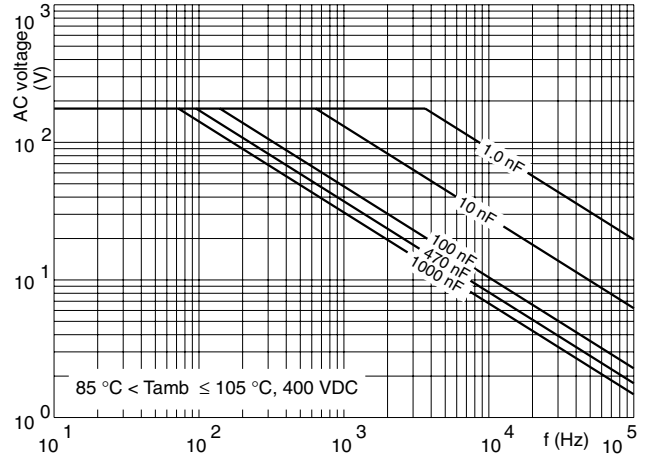
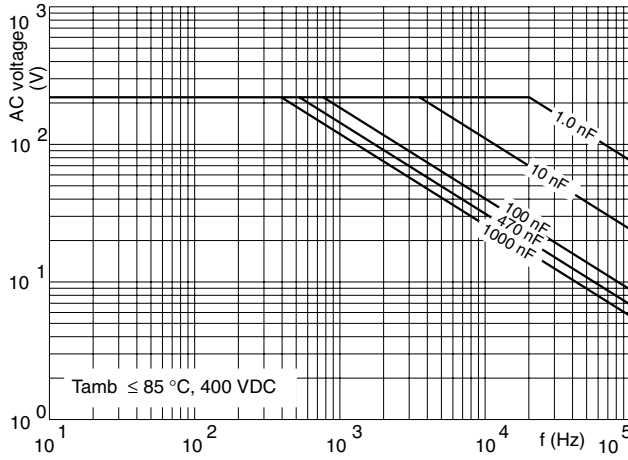



## Disclaimer

All product specifications and data are subject to change without notice.

Vishay Intertechnology, Inc., its affiliates, agents, and employees, and all persons acting on its or their behalf (collectively, "Vishay"), disclaim any and all liability for any errors, inaccuracies or incompleteness contained herein or in any other disclosure relating to any product.

Vishay disclaims any and all liability arising out of the use or application of any product described herein or of any information provided herein to the maximum extent permitted by law. The product specifications do not expand or otherwise modify Vishay's terms and conditions of purchase, including but not limited to the warranty expressed therein, which apply to these products.

No license, express or implied, by estoppel or otherwise, to any intellectual property rights is granted by this document or by any conduct of Vishay.

The products shown herein are not designed for use in medical, life-saving, or life-sustaining applications unless otherwise expressly indicated. Customers using or selling Vishay products not expressly indicated for use in such applications do so entirely at their own risk and agree to fully indemnify Vishay for any damages arising or resulting from such use or sale. Please contact authorized Vishay personnel to obtain written terms and conditions regarding products designed for such applications.

Product names and markings noted herein may be trademarks of their respective owners.